

Induction Counter-Top Series

Single & Dual Cook Zones

Instructions For Installation And Use

 **CAUTION:** Read the instruction before using the machine.

 **WARNING:** If the surface is cracked, immediately disconnect the appliance or appropriate of the appliance from supply.

Note: This device line is intended for professional use only.

models

INSTINCT Hob 3

INSTINCT Hob 3.5

INSTINCT Hob 5

INSTINCT Hob 7 (only 3Ph. 208VAC)

INSTINCT Hob 10

INSTINCT Wok 3

INSTINCT Wok 3.5

INSTINCT Wok 5

INSTINCT Wok 8

Translation of Original Instruction – English



GreenHeat



This Manual can also be
found on www.inducs.com

READ THIS MANUAL

Warning

Read this manual thoroughly before installing, operating, or performing maintenance on the equipment. Failure to follow instructions in this manual can cause property damage, injury or death.

This manual must always be available for reference at the place of operation.

This manual is intended for kitchen consultants, cabinet designers, fabricators, installers, owners and operators of our appliances.

Owners, consultants, fabricators and designers:

In order for the appliance to function safely and normally, you must read and understand all specific and critical requirements (such as location, ventilation, clearance) when designing the location and/or the electrical cabinet for the appliance.

Installers, operators and staff:

For your safety and safety of the others, you must observe all safety instructions during installation, operation and maintenance of the equipment.

Should you require technical assistance, call your factory authorized service agent or distributor.

Always have your model and serial number available when you call.

Your Factory Authorized Service Company and Contact Information

Your Equipment Supplier and Contact Information

Model Number

Serial Number

Date of Installation

ABOUT THIS MANUAL

Throughout this manual, the induction appliance model indicated on the cover page is referred to as **appliance, induction appliance or equipment.**

A period (.) is used in this manual as the decimal separator.

Original measurements are in metrics. Measurements in imperial are provided for reference.

Not ALL models, options and accessories are available in all geographical regions. Please consult your equipment supplier for the availability of the specific products in your region.

INSPECT THE SHIPMENT

Thoroughly inspect the equipment upon delivery. Immediately report to the delivery carrier, any damage that occurred during transportation and request for a written inspection report from a claim inspector.

Keep all packages.

KEEP THE PACKING SLIP

The packing slip attached to the shipment contains detailed information on all components. Keep the packing slip for reference.

Safety Notices

DEFINITIONS

DANGER

Indicates a hazardous situation that, if not avoided, will result in death or serious injury. This applies to the most extreme situations.

Warning

Indicates a hazardous situation that, if not avoided, could result in death or serious injury.

Caution

Indicates a hazardous situation that, if not avoided, could result in minor or moderate injury.









Notice

Indicates information considered important, and is used to address practices not related to physical injury. For example, messages relating to property damage.

NOTE: Indicates useful, extra information about the procedure you are performing.

Reference: ANZI Z535.6-2011

SAFETY SYMBOLS AND WARNINGS ON THE APPLIANCE

	This symbol alerts you to a hazardous situation that WILL or COULD cause serious bodily harm or death. Be alert and implement relevant safety precautions.
	DANGER - HIGH VOLTAGE This dangerous voltage warning symbol indicates a risk of electric shock and hazards from dangerous voltage.
	Electromagnetic Field This symbol warns against non-ionizing electromagnetic radiation.
	Equipotential bonding This symbol marks the terminal which has to be connected with the equipotential bonding system.
 Warning  RISK OF FIRE OR ELECTRIC SHOCK! DO NOT OPEN! To reduce the risk of fire or electric shock, do not remove or open cover. No user-serviceable parts inside. Refer servicing to qualified personnel.	
 DANGER Disconnect from supply circuit before opening.	
CAUTION  ATTENTION DISCONNECT FROM SUPPLY CIRCUIT BEFORE OPENING COUPER L'ALIMENTATION ELECTRIQUE AVANT D'OUVRIR DESCONECTAR DEL CIRCUITO DE SUMINISTRO ANTES DE ABRIR Αποσυνδέστε από τον καλωδιακό εξοπλισμό πριν ανοίξετε إ فصل الجهاز عن الدائرة الكهربائية قبل الفتح.	

DISCLAIMERS**⚠ DANGER**

Disregarding any safety instructions may cause harm to people, the surroundings, and the equipment. The manufacturer and/or authorized representative are not responsible for any damages or personal injury caused by failure to observe any safety instructions. Risks involved when disregarding safety instructions include, but not limiting to:

- Death or injury caused by electric shock.
- Burn injury caused by contacting hot cooking surface, cookware, or oil and grease.
- Damage to the equipment caused by using unsuitable cookware.

⚠ DANGER

Do not install or operate equipment and/or accessories that have been misused, abused, neglected, damaged, or altered from that of original manufactured specifications.

⚠ DANGER

Contact the manufacturer if you intend to make any changes on the equipment. For safety reasons, always use genuine parts and accessories approved by the manufacturer or authorized representative. Refer to the warranty documents for your equipment.

⚠ Warning

The single phase models have a power inlet intended to make the model universal. Using a cord that is not factory supplied can lead to several hazards if the wrong cord and plug attachment is installed and used. Example fire and burn hazard, risk of electric shock, risk or failure to function correctly.

⚠ DANGER

Owners and operators are cautioned that maintenance and repairs must be performed by an authorized service agent using only genuine replacement parts. The manufacturer will have no obligation with respect to any product that has been improperly installed, adjusted, operated or not maintained in accordance with national and local codes and/or installation instructions provided with the product or any product that has its serial number defaced, obliterated or removed, and/or which has been modified or repaired using unauthorized parts or by unauthorized service agents.

⚠ DANGER

Improper installation, adjustment, alteration, service, or maintenance of this appliance or installation of a damaged appliance can result in DEATH, INJURY, EQUIPMENT DAMAGE, and void the warranty.

⚠ DANGER

All utility connections and fixtures must be maintained in accordance with local and national codes.

⚠ Warning

Do not store or use gasoline or other flammable vapors or liquids in the vicinity of this or any other appliance. Never use flammable oil soaked cloths or combustible cleaning solutions for cleaning.

⚠ Warning

This appliance is not intended for use by persons (including children) with reduced physical, sensory or mental capabilities, or lack of experience and knowledge, unless they have been given supervision concerning use of the appliance by a person responsible for their safety. Do not allow children to play with this appliance.

⚠ Warning

This product contains chemical known to the State of California to cause cancer and/or birth defects or other reproductive harm. Operation, installation, and servicing of this product could expose you to airborne particles of glass-wool or ceramic fibers, crystalline silica, and/or carbon monoxide. Inhalation of airborne particles of glass-wool or ceramic fibers is known to the State of California to cause cancer. Inhalation of carbon monoxide is known to the State of California to cause birth defects or other reproductive harm.

⚠ Warning

Authorized Service Representatives are obligated to follow industry standard safety procedures, including, but not limited to, local/national regulations for disconnection / lock out / tag out procedures for all utilities including electric, gas, water and steam.

Notice

This appliance is not approved or authorized for home or residential use, but is intended for commercial applications only. The manufacturer and/or authorized representative will not provide service, warranty, maintenance or support of any kind other than in commercial applications.

Notice

Routine adjustments and maintenance procedures outlined in this manual are not covered by the warranty.

NOTE: Proper installation, care and maintenance are essential for maximum performance and trouble-free operation of your equipment. Visit our website for manual updates, translations, or contact information for service agents in your area.

CORRECT DISPOSAL OF THIS PRODUCT



This marking shown on the product indicates that the product should not be disposed as household waste or regular commercial waste. Instead it shall be handed over to the applicable collection point for the recycling of electrical and electronic equipment. By ensuring this product is disposed correctly, you will help prevent potential harm to the environment or human health, which could otherwise be caused by inappropriate waste handling of this product.

For more detailed information regarding recycling of the product, please contact your local city office or your waste disposal service.

⚠ DANGER

Induction appliances, sent for disposal, can be brought back into operation and their use must be avoided.

NOTE: The appliance is built with common electrical, electromechanical and electronic parts. No batteries are used.

NOTE: The owner and operator are responsible for the proper and safe disposal of the appliance.

Important

Additional Safety Notices are stated in the relevant sections throughout the manual.



Table of Contents

Safety Notices

Definitions	4
Safety symbols and Warnings on the Appliance	4
Disclaimers	5
Correct Disposal of this Product	6

Table of Contents

Section 1

General Information

Description of Product	10
Application	10
Compliances	10
Serial Plate Location	11
Model Number	11
Reading the Model Number	11
Serial Number	11
Accessories	11

Section 2

Installation

Installation Safety—Disclaimer.....	12
Installation Safety—Clearance and Ventilation	12
Installation Safety—Electrical.....	13
Personal Protection	14
Specifications	15
Dimensions: INSTINCT Hob 3, INSTINCT Hob 3.5, INSTINCT Hob 5 ..	15
Dimensions: INSTINCT Hob 7, INSTINCT Hob 10	16
Dimensions: INSTINCT Wok3, INSTINCT Wok3.5, INSTINCT Wok 5, INSTINCT Wok 8	17
Electrical Specifications	18
Electrical Cables.....	18
Installation Clearance	18
Operating Conditions.....	19
Weights.....	19
Installation Instructions	20
Location of the Induction Appliance	20
Ventilation Requirements	20
Adjusting Legs.....	20
Commissioning.....	21
Function Test	21

**Section 3
Operation**

Operation Safety—Disclaimer.....22
 Operation Safety—Personal Protection.....23
Important Rules—Operation and Maintenance.....25
Proper Induction Cookware26
 Condition26
 Round bottom Wok pans26
 Material.....26
 Boil Test.....26
 Size of Pan.....27
Placing Pan On A Cook Zone27
Display and Control Quick Reference29
Control30
 Turn unit on.....30
 LED Ring30
 Switching Between cooking and holding modes30
 Setting Power Level (1 to 12) and Lock/Unlock30
 Selecting hold Temperature and Lock/Unlock.....30
 Setting the Timer.....31
 Turning off31
Additional Settings31
Automatic Pan Detection, No Pan No Heat32
When Appliance Is Idle32
Decommissioning32

**Section 4
Maintenance**

Maintenance Safety—Disclaimer.....33
 Dangerous Electrical Voltage.....33
 Maintenance Safety—Cleaning.....33
 Personal Protection34
Daily Cleaning and Maintenance35
 Glass Cleaning35
 Stainless Steel35
 Visual Inspection of Silicone Seal35
Weekly Cleaning and Maintenance36
 Air Intake Filter36
Yearly Maintenance.....37



Section 5
Troubleshooting

Dangerous Electrical Voltage.....	38
Common Problems.....	38
Symptoms.....	38
Boil Test.....	39
Dangers avoidance in case of accidents or malfunctions.....	39
Troubleshooting Without Error Code.....	40
Troubleshooting — Error Code.....	42



Section 1

General Information

Description of Product

Built with a robust construction, our induction appliances are compact and powerful with the revolutionary RTCSmp® Technology (Realtime Temperature Control System).

The RTCSmp® Technology monitors continuously in realtime, the energy supply, temperature of the cook zone and the state of the components such as the induction coil. This monitoring system ensures the most efficient energy transfer, as well as maximizes safety:

- Safety functions such as Pan Detection and Boil Dry Protection are therefore guaranteed.
- The appliance starts heating only when a pan is placed in the cook zone.
- When a malfunction occurs, the integrated fault diagnostic system reports the malfunction instantly.

Application

The RTCSmp® induction appliances are designed as compact equipment for use on the surface of a counter or table.

Many applications throughout the day with your appliance are possible, such as cooking, warming up, keeping warm, flambéing, and roasting of food. All these applications are possible because:

- Temperature control is instantaneous and precise. Instant energy transmission from induction coil to the bottom of cookware, allows for fast startup time.
- High power is possible for braising application and quick sauté.
- High power also means you can heat up a large stockpot quickly.

NOTE: To guarantee the reliability and performance of the appliance, you must use the recommended types and sizes of pans with the appliance. See section 3 Operation.

Compliances



400V and 208V-230V models comply with the latest European Norms:

EN 55014-1	EN 55014-2
EN 60529	EN 62233 (EMC/EMV)
EN 60335-1	EN 60335-2-36
EN 61000-3-11	EN 61000-3-12

208V and 208V-240V models comply with the latest North American Norms:

UL 197
cULus Listed to CSA 22.2 109-M1981
UL 746C
FCC (CFR Title 47 Part 8 and Part 15B)
ICES-001 (Issue 4)
ICES-003 (Issue 6)
UL Sanitation to NSF 4

This device complies with Part 15 and 18 of the FCC Rules. Operation is subject to the following conditions: (1) This device may not cause harmful interference, and (2) This device must accept any interference received, including interference that may cause undesired operation.

This ISM device complies with Canadian ICES-001.

Cet appareil ISM est conforme à la norme NMB-001 du Canada.

UL File No: E502348, E505967

Serial Plate Location

The serial plate is located on the bottom panel of the unit. It specifies the model number, serial number, and electrical specifications of the appliance.

Model Number

The model number is located on the serial plate. This manual covers only the models specified on the front cover of this manual.

Reading the Model Number

INSTINCT Hob	Cooktop
INSTINCT Wok	Single Wok
3.5 / 5 / 8 / 7 / 10	Total power in kW NOTE: 10 kW indicates dual cooktops

Serial Number

Serial number is located on the serial plate.

Accessories

Induction cooking equipment requires **Induction Ready** pans to operate. Please consult your equipment supplier for a list of our pan selection and prices.



Notice—Wok Equipment

Use Wok Pans with Correct Contour

The wok pans used must be the correct contour to the Ceran® glass wok bowl. To reduce premature failures such as overheating, wok pans should not touch the glass but only sit on the upper flange.

To guarantee the correct contour, we offer a selection of induction wok pans. Please consult your equipment supplier for details.





LIMITED WARRANTY FOR INDUCTION PRODUCTS (U.S.A & Canada)

LIMITED WARRANTY

During the warranty period, Garland shall repair or, at Garland's option, replace parts determined by Garland to be defective in material or workmanship, and with respect to services, shall re-perform any defective portion of said services.

The foregoing shall be the sole obligation of Garland under this Limited Warranty with respect to the equipment, products and services. With respect to equipment, materials, parts and accessories manufactured by others, Garland's sole obligation shall be to use reasonable efforts to obtain the full benefit of the manufacturers' warranties. Garland shall have no liability, whether in contract, tort, negligence, or otherwise, with respect to non-Garland manufactured products.

EXCLUSIONS FROM COVERAGE

- This Limited Warranty is available only to the original purchaser of the product and is not transferable. You must have your original sales receipt for warranty coverage.
- Repair or replacement of parts required because of misuse, improper care or storage, negligence, alteration, accident, damage in shipment, fire, floods, power changes, use of incompatible supplies or lack of specified maintenance, other hazards or acts of God shall be excluded.
- Warranty protection is only offered for equipment installed with the procedures described in the Garland operations and installation manual.
- Normal maintenance items, including but not limited to, light bulbs, fuses, gaskets, O-rings, interior and exterior finishes, lubrication, de-liming, broken glass, etc.
- Adjustments and calibration of temperatures, speed and air flows.
- Failures caused by erratic voltages or gas supplies.
- Where equipment is being used for applications other than those approved by Garland Equipment exported to foreign countries.
- Consequential damages (the cost of repairing other property which is damaged), loss of time, profits, use or any other non-cooking related incidental damages of any kind.
- Travel costs beyond 100 miles in the USA and 150 km in Canada, or two (2) hours, travel other than overland, overtime, holiday charges, and any special arrangements.
- Any travel costs above actual time (One-way travel ONLY paid).
- Any charges additional to the SRT (Standard Repair Times) will be authorized and paid at the discretion of Garland.
- Improper or unauthorized repair.
- Flame safety components on all ranges - 90 days from the original equipment installation date.
- This Limited Warranty does not apply and shall not cover any products or equipment manufactured or sold by Garland when such products or commercial equipment is installed or used in a non-commercial application. Installation not within the applicable building or fire codes render this Limited Warranty and any responsibility or obligations associated therein null and void. This includes any damage, costs or legal actions resulting from the installation of any Garland manufactured commercial cooking or warming equipment in a non-commercial application or installation.

LIMITATIONS OF LIABILITY

The preceding paragraphs set forth the exclusive remedy for all claims based on failure of, or defect in, products or services sold hereunder, whether the failure or defect arises before or during the warranty period, and whether a claim, however instituted, is based on contract, indemnity, warranty, tort (including negligence), strict liability, implied by statute, common-law or otherwise. Garland, its servants and agents shall not be liable for any claims for personal injuries or consequential damages or loss, howsoever caused. Upon the expiration of the warranty period, all such liability shall terminate. THE FOREGOING WARRANTIES ARE EXCLUSIVE AND IN LIEU OF ALL OTHER WARRANTIES, WHETHER WRITTEN, ORAL, IMPLIED OR STATUTORY. NO IMPLIED WARRANTY OF MERCHANTABILITY OR FITNESS FOR PARTICULAR PURPOSE SHALL APPLY. GARLAND DOES NOT WARRANT ANY PRODUCTS OR SERVICES OF OTHERS.

REMEDIES

- The liability of Garland for breach of any warranty obligation hereunder is limited to: (i) the repair or replacement of the equipment on which the liability is based, or with respect to services, re-performance of the services; or (ii) at Garland's option, the refund of the amount paid for said equipment or services.
- Any breach by Garland with respect to any item or unit of equipment or services shall be deemed a breach with respect to that item or unit or service only.

ALL GARLAND PRODUCTS

Garland Commercial Ranges Limited ("Garland") warrants all products to be free from defects in material and workmanship for a period of 1 year from the date the product is installed or 18 months from the date of shipment from our factories, whichever comes first, unless stated otherwise for specific models or product lines.

PRODUCT SPECIFIC LIMITED WARRANTY

Heavy duty equipment, Garland Master Series, Garland Induction, U.S. Range Cuisine are warranted to be free from defects in material and workmanship for a period of two (2) years from the date the product is installed or thirty (30) months from the date of shipment from our factory, whichever comes first and one (1) year parts and/or labor.

Stainless steel fry pots are warranted to be free from defects that would cause shortening leaks due to weld failures for the period of one (1) year parts and labor. The stainless-steel fry pots are warranted for five (5) years, however, after one (1) year the warranty is limited to replacement parts only.

General Market Clamshell Grills/Broilers:

In Canada/USA, are warranted to be free from defects in material and workmanship for a period of two (2) years from the date the product is installed or thirty (30) months from the date of shipment from our factory, whichever comes first and two (2) years parts and/or labor.

All other regions, are warranted to be free from defects in material and workmanship for a period of one (1) year from the date the product is installed or thirty (30) months from the date of shipment from our factory, whichever comes first and two (2) years parts and one (1) year labor.

Convection oven warranty coverage:

- Garland MCO (full size only) models: two (2) years limited parts and one (1) year labor. Door warranty five (5) years limited parts except window.
- Sunfire models: one year (1) limited parts and one (1) year labor. Door warranty three (3) years limited parts except window.
- U.S. Range Summit models: one (1) year limited parts and one (1) year labor. Door warranty five (5) years limited parts except window.

During the warranty period, Garland shall repair or, at Garland's option, replace parts determined by Garland to be defective in material or workmanship, and with respect to services, shall re-perform any defective portion of said services.

The foregoing shall be the sole obligation of Garland under this Limited Warranty with respect to the equipment, products and services. With respect to equipment, materials, parts and accessories manufactured by others, Garland's sole obligation shall be to use reasonable efforts to obtain the full benefit of the manufacturers' warranties. Garland shall have no liability, whether in contract, tort, negligence, or otherwise, with respect to non-Garland manufactured products.

Note: Warranty terms may vary based on agreement at time of purchase.

OVERVIEW OF GENERAL WARRANTY STATEMENTS

WHAT WE WILL DO

We will repair or replace the defective appliance, component or part. Such repair or replacement will be at the expense of Garland except for any travel costs above actual time (one-way travel ONLY paid).

REPLACEMENT PARTS

Parts, 90 days, no labor. KitchenCare 1-844-724-2273 Fax:1-812-406-4100.

HOW TO GET SERVICE

Contact our Factory Authorized Service agent to obtain warranty service. To find the name and location of the nearest FAS call your dealer, or call the Garland Service Line at 1-844-724-2273. You can also go the Garland website, www.garland-group.com, select Service, select Locator, key in zip code and you will be given the FAS for the zip code entered. When calling for service, please ensure you have the model number, serial number and date of purchase or installation and description of the problem. You must keep sales receipts for proof of the date of purchase.

WARRANTY CLAIM PROCEDURE

Customer shall be responsible to:

- Immediately advise the Dealer or Garland Factory Authorized Service Agency of the equipment serial number and the nature of the problem. For a list of authorized service agents, please refer to the Garland web site at www.garland-group.com
- Verify the problem is a factory responsibility. Improper installation, gas adjustments or misuse of equipment are not covered under this Limited Warranty.
- Cooperate with the Service Agency so that warranty service may be completed during normal working hours.
- Submit sufficient documentation on a timely manner for reimbursement.

GOVERNING LAW

For equipment, products and services sold in Canada this Limited Warranty shall be governed by the laws of the province of Ontario, Canada; otherwise this Limited Warranty shall be governed by the laws of the state of Delaware, U.S.A., excluding their conflicts of law principles. The United Nations Convention on Contracts for the International Sale of Goods is hereby excluded in its entirety from application to this Limited Warranty.

Garland Commercial Ranges Ltd.

1177 Kamato Road, Mississauga, Ontario, Canada L4W 1X4

844-724-CARE

WWW.GARLAND-GROUP.COM



Section 2 Installation

INSTALLATION SAFETY—DISCLAIMER

DANGER

Installation must be carried out by registered installation contractors only.

The contractors are responsible for interpreting all instructions correctly and performing the installation in compliance with all applicable national and local regulations.

The warning signs and serial plates on the equipment must strictly be followed.

Warning

This equipment is intended for indoor use only. Do not install or operate this equipment in outdoor areas.

Warning

To avoid instability, the installation area must be capable of supporting the combined weight of the equipment and food product. The equipment must be level side to side and front to back.

Caution

Consultants, fabricators and designers must consult their counter-top suppliers when designing an appropriate support structure and clearance for the counter-top and the installation.

Notice

Induction equipment that is not installed correctly will have warranty voided.

INSTALLATION SAFETY—CLEARANCE AND VENTILATION

DANGER

Risk of Fire or Shock or Equipment Failure

All minimum clearances must be maintained. Air intake vents and exhaust vents must not be blocked or be restricted by the installation.

Caution

This equipment must only be operated under an approved ventilation system in accordance with all applicable national and local regulations. Exceptions may apply.

Notice

The maximum ambient temperature for the induction appliance to operate must not exceed 40°C [104°F].

Failure to provide adequate ventilation will cause the appliance to overheat, to reduce power, or to shutdown.

NOTE: Always maintain enough space between and around the equipment for maintenance and service.

INSTALLATION SAFETY—ELECTRICAL**⚠ DANGER**

All electrical connections must be carried out by a certified electrical contractor, who is responsible for the correct rating and installation of the appliance. The contractor has to comply with all legal safety regulations and all applicable national and local electrical codes.

⚠ Warning

Markings and warning labels mounted directly on the equipment must be observed at all times and kept in a fully legible condition.

⚠ Warning

This equipment must be positioned so that the plug is accessible unless other means for disconnection from the power supply, such as circuit breaker or disconnect switch, is provided.

⚠ Warning

CE Induction Appliance only: If ground fault current protective switches are used, they must be designed for a minimum fault current of 30mA, Type B or B+.

Notice

Ensure the supply voltage and the line current match the specifications given on the serial plate affixed to the appliance. Wrong voltage will damage the appliance. A stable power supply must be provided.

Notice

Always refer to the serial plate on the appliance to verify the electrical data. When the data listed on the serial plate is different than that listed in this manual, contact the manufacturer or the authorized representative.

Notice

All cables must be routed, protected and tension free.

PERSONAL PROTECTION**⚠ DANGER**

All utilities (gas, electric, water and steam) must be OFF to all equipment and locked out of operation according to national/regional, as well as company approved practices during installation, maintenance and servicing. Always allow appliance to cool.

⚠ DANGER

Use appropriate safety equipment during installation, maintenance and servicing.

⚠ DANGER

Never stand, sit, or lean on the equipment! They are not designed to hold the weight of an adult, and may collapse or tip if misused in this manner.

⚠ DANGER

To avoid cardiac pacemaker malfunction, consult your physician or pacemaker manufacture about effects of electromagnetic field on your pacemaker.

⚠ DANGER

Replace defective power cables immediately by an authorized service agency.

⚠ Warning

Markings and warning labels mounted directly on the equipment must be observed at all times and kept in a fully legible condition.

⚠ Warning

Risk of burns from high temperatures. You may get burnt if you touch any of the parts during operation. Surfaces close to the cooking area including side panels may get hot enough to burn skin. Use extreme caution to avoid coming in contact with hot surfaces or hot grease. Wear personal protective equipment.

⚠ Caution

Use caution when handling metal edges of all equipment.

Specifications

DIMENSIONS: INSTINCT HOB 3, INSTINCT HOB 3.5, INSTINCT HOB 5

Dimensions are specified in mm [inches].

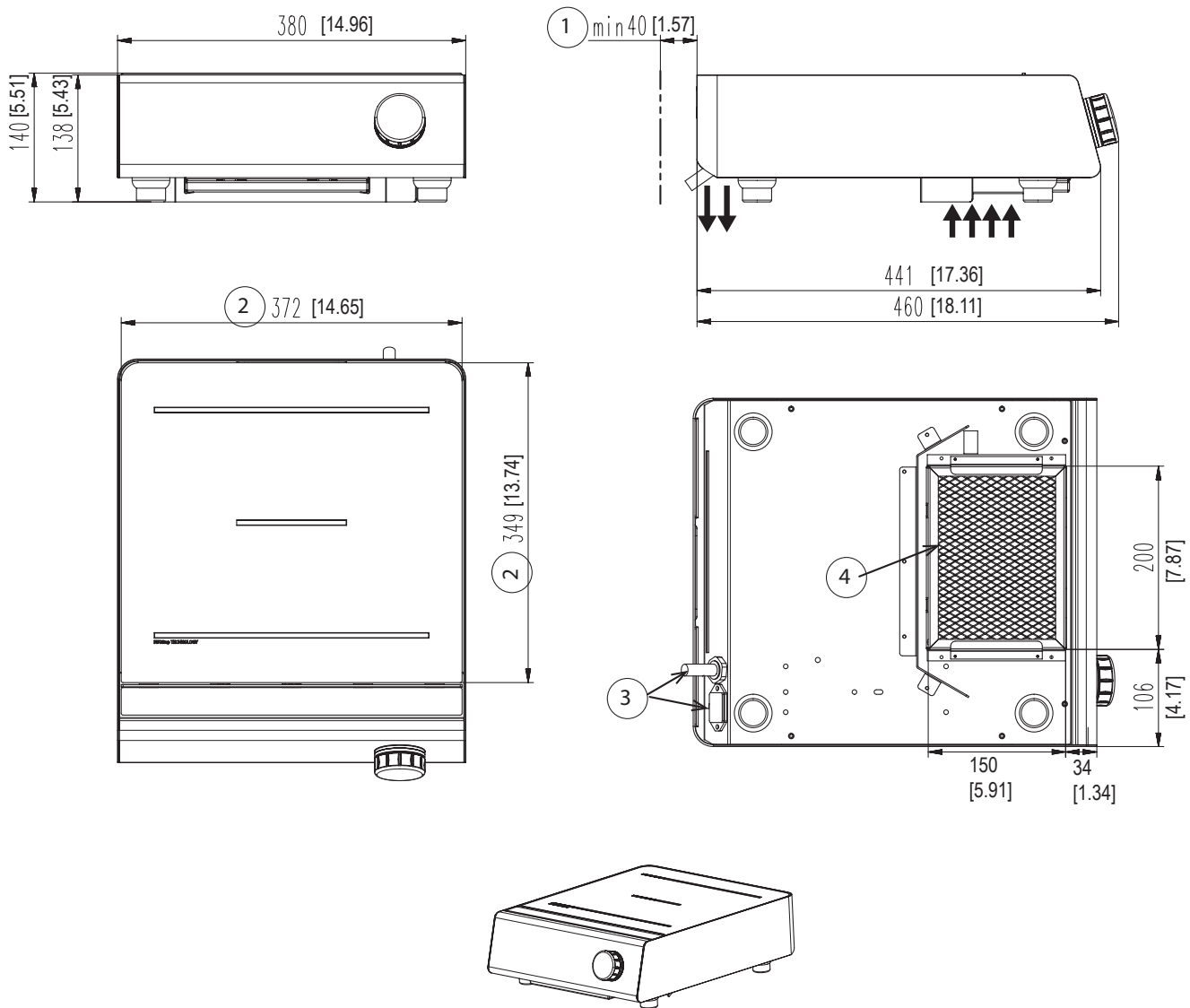



➔	Indicates the direction of airflow
1	Distance to wall or other obstruction, minimum = 40mm [1.57"]
2	Ceran Glass Cook Top Dimensions
3	Power Cable Connection
4	Air Filter

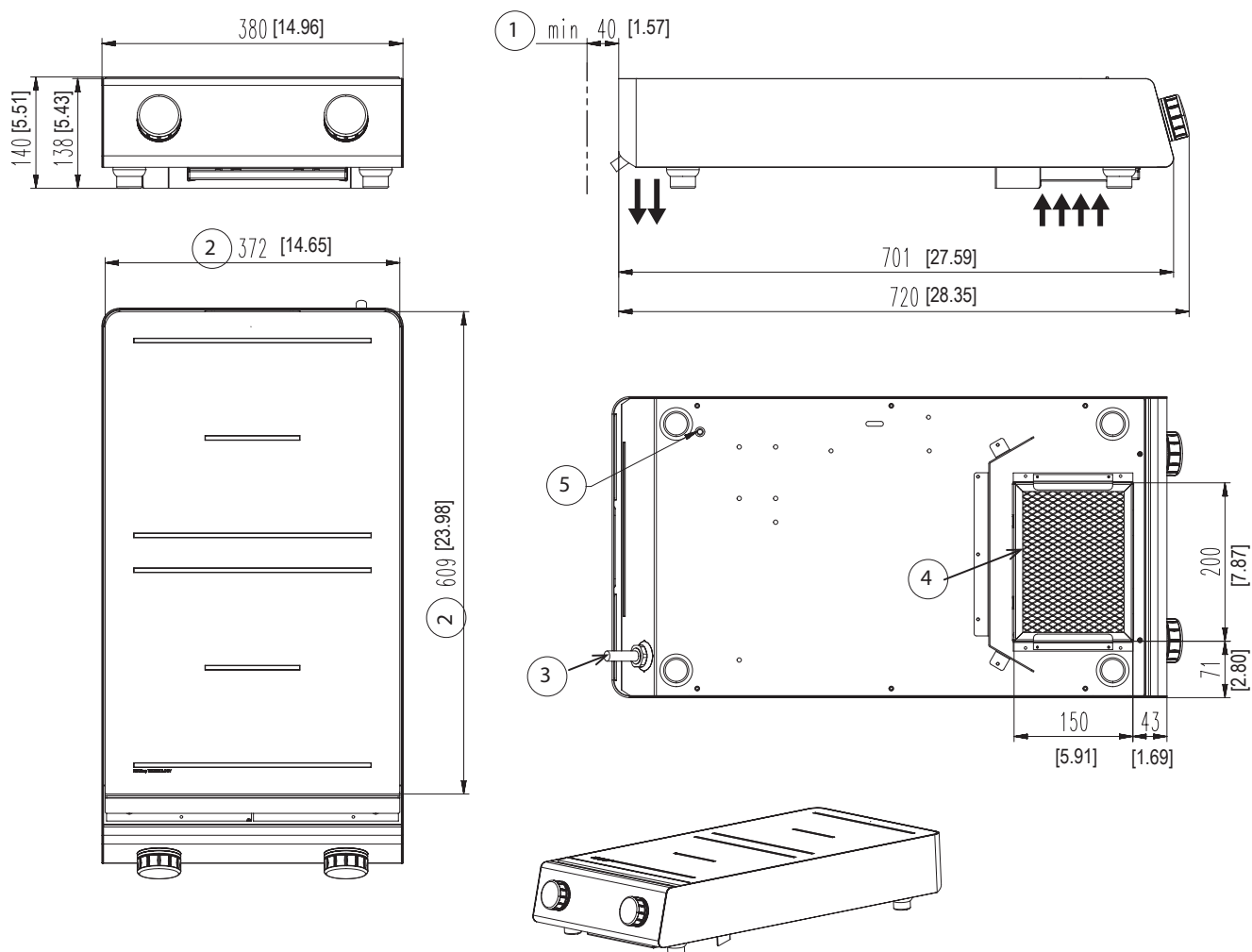

DIMENSIONS: INSTINCT HOB 7, INSTINCT HOB 10

Dimensions are specified in mm [inches].



➔	Indicates the direction of airflow
1	Distance to wall or other obstruction, minimum = 40mm [1.57"]
2	Ceran Glass Cook Top Dimensions
3	Power Cable Connection
4	Air Filter
5	Equipotential bonding point  (EN60335)





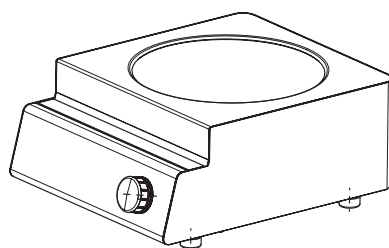
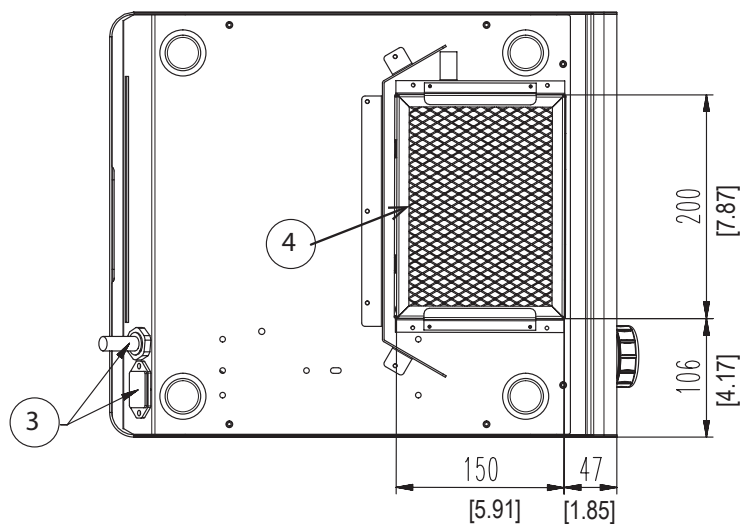
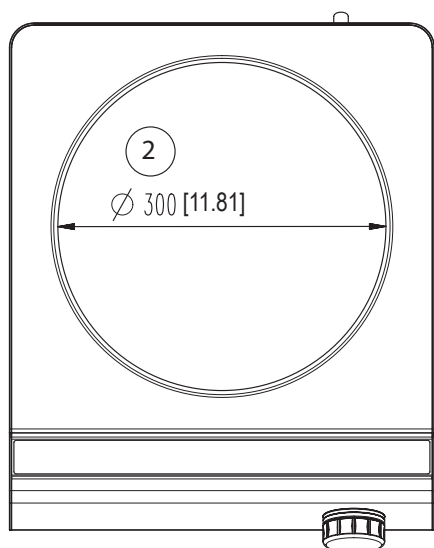
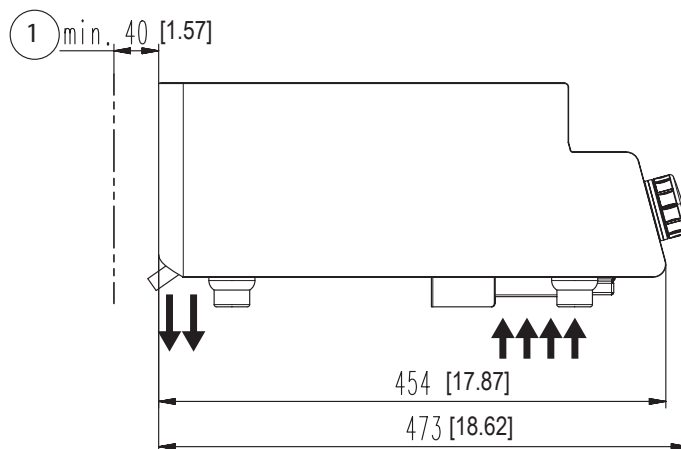
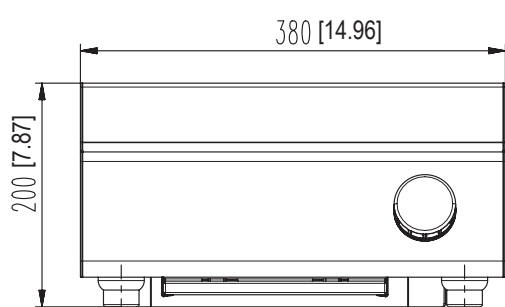









DIMENSIONS: INSTINCT WOK3, INSTINCT WOK3.5, INSTINCT WOK 5, INSTINCT WOK 8

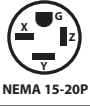
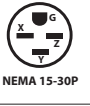

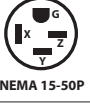
➔	Indicates the direction of airflow
1	Distance to wall or other obstruction, minimum = 40mm [1.57"]
2	Ceran Glass Wok Bowl Diameter
3	Power Cable Connection
4	Air Filter



ELECTRICAL SPECIFICATIONS

Model	Power / Current	Voltage / Phases	Plug
INSTINCT Hob 3	3000W / 13A	230V / 1Φ	
INSTINCT Hob 3.5	3500W / 16A	230V / 1Φ	
	3500W / 17A	208V / 1Φ 208V / 2Φ	
INSTINCT Hob 5	5000W / 8A	400V / 3Φ	
	5000W / 14A	208V / 3Φ	
INSTINCT Hob 7	7000W / 20A	208V / 3Φ	
INSTINCT Hob 10	10000W / 16A	400V / 3Φ	
	10000W / 28A	208V / 3Φ	
INSTINCT Wok 3	3000W / 13A	230V / 1Φ	
INSTINCT Wok 3.5	3500W / 16A	230V / 1Φ	
	3500W / 17A	208V / 1Φ 208V / 2Φ	
INSTINCT Wok 5	5000W / 8A	400V / 3Φ	
	5000W / 14A	208V / 3Φ	

Model	Power / Current	Voltage / Phases	Plug
INSTINCT Wok 8	8000W / 12A	400V / 3Φ	

ELECTRICAL CABLES

Power supply cable and plug are included, 1.8-meter [6-foot] long.

INSTALLATION CLEARANCE

Notice

The orientation of each appliance in a parallel configuration will affect the ventilation requirements. Ensure the final installation meets all operating and ventilation requirements.

Refer to example below:

	Indicates the direction of airflow
a	Distance to wall or other obstruction, minimum = 40mm [1.57"]
y	A gap between two countertop units is not required.

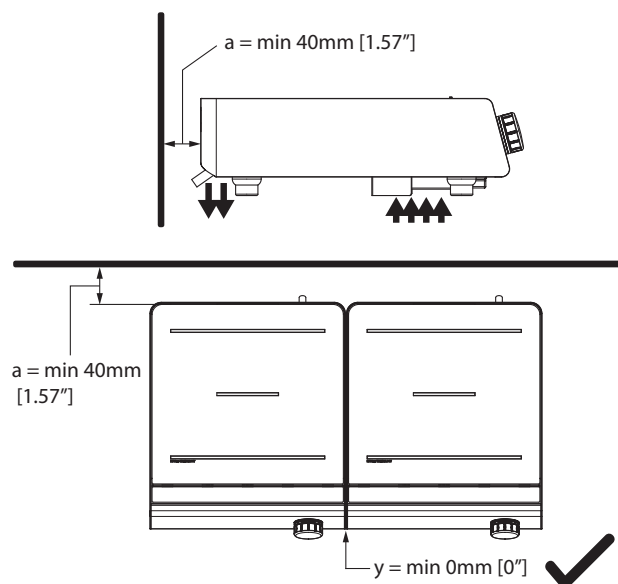

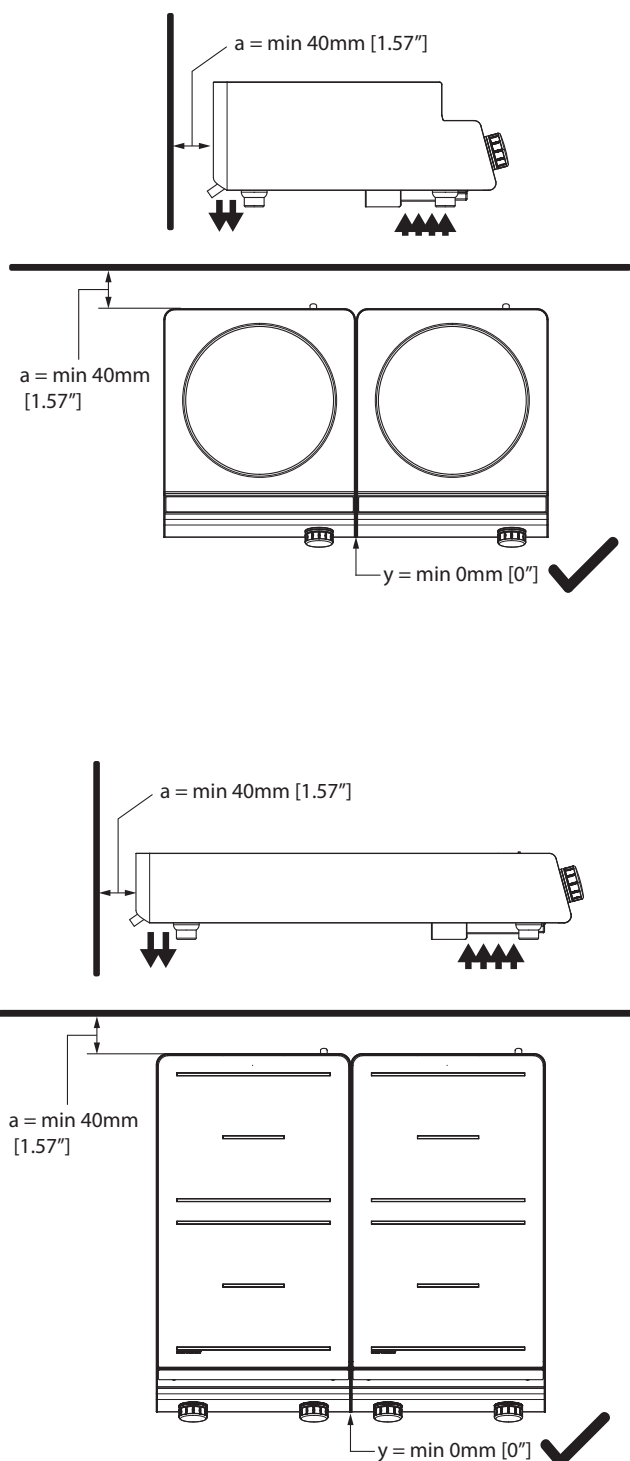

OPERATING CONDITIONS

For the appliance to function properly, the following conditions must be maintained.

Maximum Tolerance of the Nominal Supply Voltage	+6 /-10 %
Supply frequency	50/60 Hz
Ingress Protection class	IP X3
Minimal Diameter of Induction Pan	12cm [5"]
Maximum Ambient Temperature	In Storage, -20°C to +70°C [-4°F to +158°F]
	In Operation, +5°C to +40°C [+41°F to +104°F]
Maximum Relative Air Humidity	In Storage, 10% to 90%
	In Operation, 30% to 90%
Noise level	< 43dB

WEIGHTS

Model	Net Weight	
	kg	lb
INSTINCT Hob 3	12	27
INSTINCT Hob 3.5	12	27
INSTINCT Hob 5	14	31
INSTINCT Hob 7	21	47
INSTINCT Hob 10	21	47
INSTINCT Wok 3	14	31
INSTINCT Wok 3.5	14	31
INSTINCT Wok 5	16	36
INSTINCT Wok 8	18	40



Installation Instructions

LOCATION OF THE INDUCTION APPLIANCE

⚠ Caution

Do not position the air intake vent near steam or heat exhaust of another appliance.

- The induction appliance must be installed on an even, flat, non-combustible surface.
- The surface must be able to hold a load of 40kg [88.2lb] per appliance that is listed in this manual.
- Ensure the induction appliance is stable and will not slide or fall down.
- The induction appliance must not be installed or placed near or on a hot surface.
- The induction appliance must be leveled.
- Similar to other electronic equipment, induction equipment is sensitive to moisture and high heat. Protect the induction appliance from heat, steam and grease generated by other equipment, such as oven, deep fryer, pasta cooker, steamers, and water bath.
- The control switches on the front panel must not be blocked or obstructed.
- Keep the induction appliance away from combustible materials, vapors or liquids.

VENTILATION REQUIREMENTS



Read and understand all installation safety instructions regarding Clearance and Ventilation at the beginning of this chapter.

- Ensure the induction appliance does not take in hot ambient air or steam from another appliance, especially when the appliance is installed next to heat generating equipment such as fryers or ovens.
- See also Installation Clearance

ADJUSTING LEGS

Adjust the height of the leg by turning the bottom part as shown:

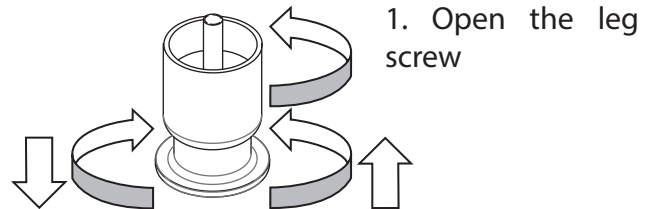

2. Adjust the height of the leg by turning the bottom part as shown.

COMMISSIONING



Read and understand all installation safety instructions regarding Electrical and Personal Protection.

1. Remove all objects from the glass-top and examine the glass.

Caution

Do not continue if the glass-top is cracked, chipped or damaged in any other way. Contact an authorized service agency for assistance.

2. Connect the appliance to power supply.
3. Test different functions of the appliance.

Function Test



- Read and understand all installation safety instructions regarding Personal Protection.
- Observe also ALL operation safety requirements in section 3 Operation.

Testing procedure:

1. Examine the cookware for induction cooking:
 - Pans must be induction ready. See details in section 3 Operation.
 - Minimum pan size: Pan must have bottom diameter larger than 12cm [5"]. Otherwise, the pan will not be heated. This is a safety feature. The sensors do not detect pan smaller than this minimum size.
2. Put some water in an induction pan and place it in the center of the cook-zone.
3. Follow operational instructions in section 3 to test:
 - Cook Mode with different power levels.
 - Hold Mode with set temperatures.
 - Lock Function
 - Timer Function
4. Remove pan away from the cook-zone, the

No Pan Icon is shown on display.

5. Place the pan back on the cook-zone and the heating process resumes.

NOTE: The LED ring illuminates continuously again when energy is being transferred to the pan.

6. Turn the appliance off. When the unit is switched off, a appears on the display.

If the appliance does not function as expected despite using quality induction pans, refer to section 5 Troubleshooting.

To test the efficiency of a pan for induction cooking, refer to section 5 Troubleshooting.

Section 3 Operation

OPERATION SAFETY—DISCLAIMER

⚠ DANGER

The on-site supervisor is responsible to train operators for operating, maintaining and ensuring that operators are made aware of the inherent dangers of operating this equipment.

⚠ DANGER

Risk of fire/shock/equipment failure. **All minimum clearances must be maintained. Do not obstruct vents or openings.**

⚠ Warning

This equipment is intended for indoor use only. Do not install or operate this equipment in outdoor areas.

Notice

The reliability of the appliance can only be guaranteed when it is used properly. The appliance must always be operated within the limits and/or the operating conditions provided in this manual.

Notice

Avoid dropping any hard objects onto the equipment. Damages to the heating surface will shorten the life cycle of the equipment or incur high service costs.

Notice—Models with Glass-Top

Use Only Induction Suitable Cookware

Use only induction suitable cookware with proper sizes and made of proper material. The induction suitable cookware must be in good condition without any uneven, arched or partially detached bottoms.

Using unsuitable cookware can cause the appliance to fail prematurely, void your warranty, and incur high service costs.

OPERATION SAFETY—PERSONAL PROTECTION

Notice

Induction appliances are more powerful, heat up pans quicker, and cook food faster than conventional cooking equipment. Your induction appliance will require different use and care than other conventional equipment.

Do not operate the equipment without reading this manual and understanding all safety requirements.

⚠ DANGER

If any part of the appliance is cracked or broken, **turn off directly the appliance and immediately disconnect the appliance from supply.** Only if it is possible and safe, disconnect the equipment from main power supply. Do not touch any parts inside the appliance.

Disconnect electric power at the main power disconnect for all equipment being serviced.

Failure to disconnect the power at the main power supply disconnect could result in serious injury or death. The knob DOES NOT disconnect incoming power.

Contact an authorized service agency for assistance.

⚠ DANGER

Do not operate any appliance with a damaged or pinched cord or a damaged plug. All repairs must be performed by a qualified service company.

⚠ DANGER

Keep power cord AWAY from HEATED surfaces. DO NOT immerse power cord or plug in water. DO NOT let power cord hang over edge of table or counter.

⚠ DANGER

To avoid cardiac pacemaker malfunction, consult your physician or pacemaker manufacturer about effects of electromagnetic field on your pacemaker.

⚠ DANGER

Never stand, sit, or lean on the equipment! They are not designed to hold the weight of an adult, and may collapse or tip if misused in this manner.

⚠ Caution

Short Cook Time

Induction appliances cook food faster than conventional cooking equipment. To avoid overheating and burning, check the cooking process frequently. Never leave the appliance unattended during operation.

⚠ Caution

Metallic objects are heated up very quickly when placed on the induction cook zone during operation. To avoid injury,

DO NOT place any objects such as closed cans, aluminum objects (aluminum foils), cutlery, jewelry, or watches on the appliance.

DO NOT place any object such as paper, cardboard, or cloth on the cooking surface, because this creates a fire hazard.

DO NOT place credit cards, phone cards, tapes, or any objects that are sensitive to magnetism on the appliance.

DO NOT use the appliance for storage.

DO NOT place any paper products, cooking utensils, cutlery, plastic vessels or food on the appliance.

DO NOT place metallic objects such as kitchen utensils, cutlery etc. on the hob surface within the cooking zones since they could get hot.

⚠ Caution

Aluminum foil must not be used with induction cook-top! Aluminum foil may ignite and cause a fire!

Notice

Do not use the cooktop for food preparation such as cutting and chopping.

⚠ Warning

Risk of burns from high temperatures. You may get burnt if you touch any of the parts during operation. Surfaces close to the cooking area including side panels may get hot enough to burn skin. Use extreme caution to avoid coming in contact with hot surfaces or hot grease. Wear personal protective equipment.

⚠ Warning

Take care when operating the appliance, as rings, watches and similar objects worn by the user could get hot when in close proximity to the hob surface.

⚠ Warning

During operation, it is possible that the floor around the unit become slippery. Wear suitable footwear and clean the floor if necessary.

Cooking with Induction Counter-Tops Models

⚠ Warning

Never Leave An Empty Pan On Cooktop

Induction appliances heat up empty pans very quickly. Never operate the appliance with an empty pan. Do not pre-heat pan. Always put food products, water or oil into the pan before turning on the appliance. Failure to do so will result in irreparable damage.

Notice

Broil-Dry Protection

Cook zones are monitored by temperature sensors. The sensors can detect overheating at the base of a cooking pan.

When an overheated pan (overheated oil, empty pan) is detected, the appliance stops transferring energy to the pan immediately. You must turn off the appliance and let it cool down before re-starting the appliance.

⚠ Caution

Do Not Touch Overheated Appliance

To avoid burn injuries, do not touch the appliance when a pan is overheated and take all the necessary precautions when removing the overheated pan.

⚠ Warning

Steam can cause serious burns. Always wear some type of protective covering on your hands and arms when removing lids or pans from the appliance. Lift the lid or pan in a way that will direct escaping steam away from your face and body.

⚠ Warning

Never leave any pan during the cooking process unattended.



Important Rules—Operation and Maintenance

Follow these simple rules to ensure reliable and repeatable performance of your induction equipment:

1 Keep kitchen temperature below 40°C [104°F].

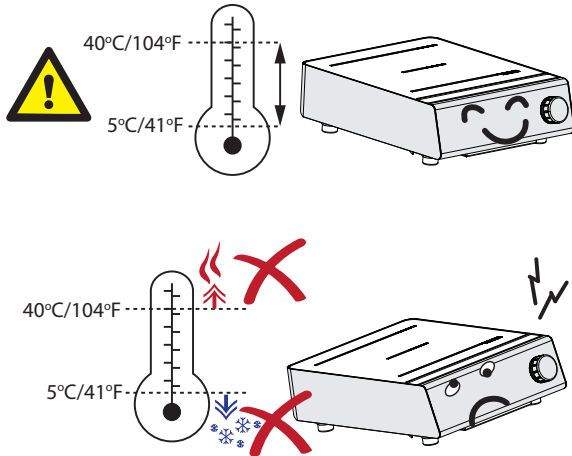

4 Use only pans that fits the glass. Do not use oversized pans.

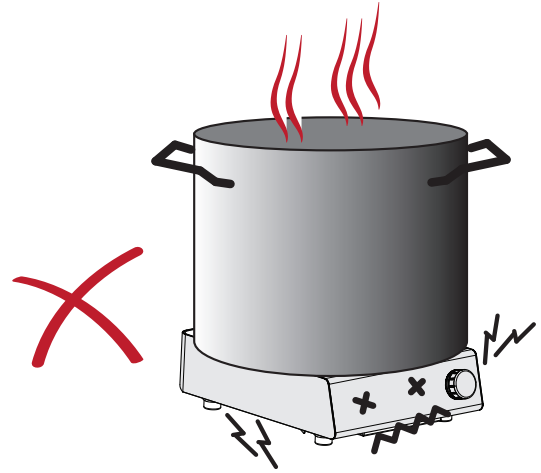

2 Never place your induction equipment next to any grease generating or heat generating equipment.

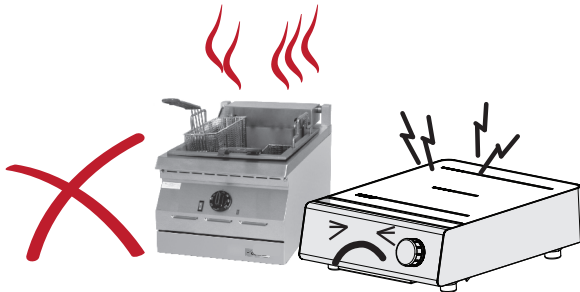

5 Never pre-heat the pan. Place the pan on the cook zone only when you are ready to cook.

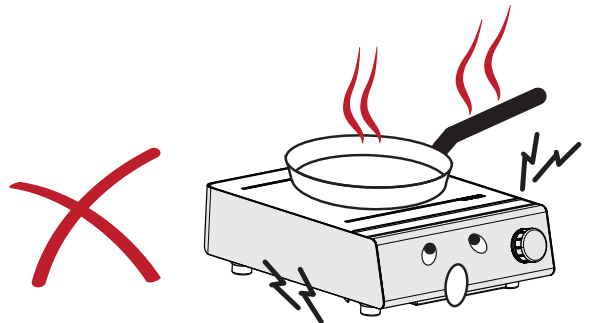

3 Clean the intake filter at least once a week or as often as required.

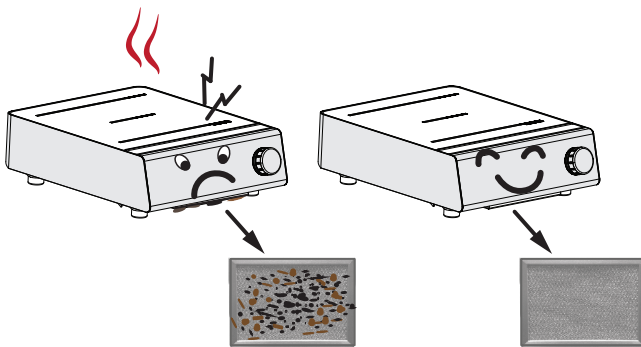

6 Do not use dented pans because it will cause damages to the electronics.

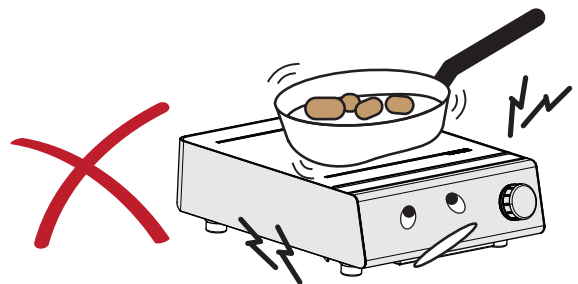

Proper Induction Cookware

CONDITION

- Pans with layer separation (outward and inward bubbles), arching or partially detached bottoms must be replaced.
- When these pans are used, the sensors under the glass-top cannot detect temperature correctly. These pans will overheat the sensors and eventually will damage the sensors and the generator. (Below, examples of good and bad pans in cross-sections.)

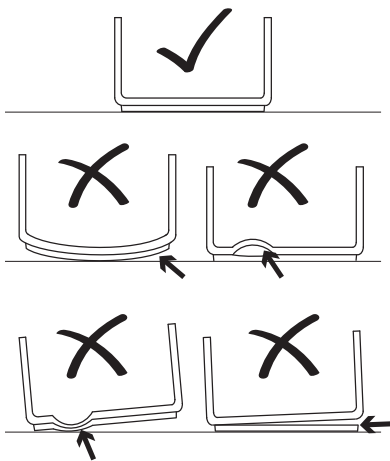

ROUND BOTTOM WOK PANS

- For models with Ceran® Glass Wok Bowls:

Notice-Wok Equipment

Use Wok Pans with Correct Contour

The wok pans used must be the correct contour to the Ceran® glass bowl. To reduce premature failures such as overheating, wok pans should not touch the glass but only sit onto the upper flange.

To guarantee the correct contour, we offer a selection of wok induction pans. Please consult your equipment supplier for details.



MATERIAL

- **USE** cookware made of **conductive and magnetic** materials. If the pan bottom attracts a magnet, the pan is suitable for induction cooking. Look for cookware that is labeled **suitable for induction** or with an induction compatible symbol.

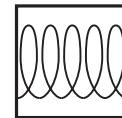

- **DO NOT USE** cookware made of aluminum, copper, glass or ceramics.
- NOTE—Steel inserts on bottom:

Cookware base inserted with areas of aluminum reduces the magnetic area for induction cooking. The appliance may supply less energy to the cookware or have difficulties in detecting the pan.

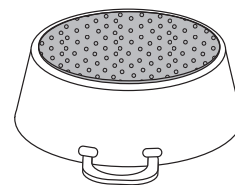

- NOTE—Non-magnetic cookware with a small magnetic base:

The exposed non-magnetic metal on the base may affect the induction field and subsequently, less energy may be supplied to the cookware.

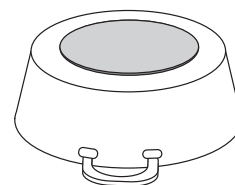

BOIL TEST

To test the efficiency of a pan for induction cooking, perform a boil test. See instructions in section 5 Troubleshooting.

SIZE OF PAN

- **MINIMUM SIZE:** The bottom of pan must have a minimum diameter of 12cm [5"] (below, dotted lines). Otherwise, the pan will not be heated. This is a safety feature such that the unit do not detect and heat up small metal objects, such as jewelry. NOTE: For personal safety, never place any small metallic objects on a cook zone.

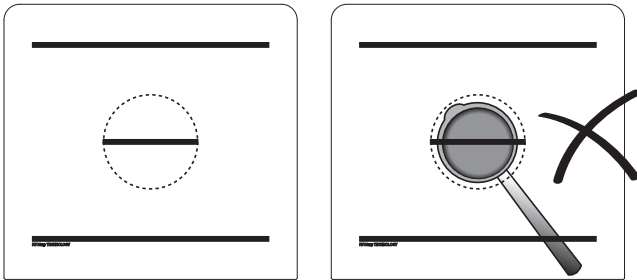

- **DO NOT USE OVERSIZED PAN!** The bottom of the pan must fit the glass. When a hot, oversized pan covers the silicone seal underneath, the heat from the pan may dry out the silicone overtime. When the silicone seal dries out and breaks, liquid can penetrate into the appliance and damage the electronics.

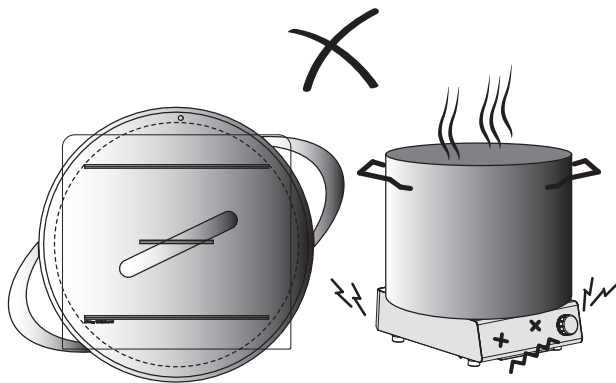

- **PAN MUST FIT THE GLASS!** The best pan to use is the one with a bottom that fits the coil (below, dotted lines).

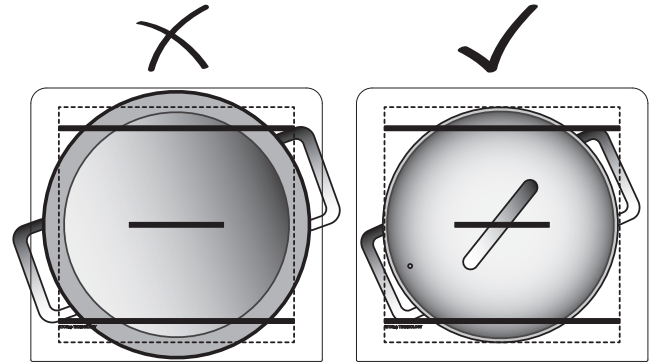

Placing Pan On A Cook Zone

Each cook zone of our appliances is equipped with the latest RTCS® or RTCSmp® sensors. These sensors monitor temperature and cookware continuously in realtime.

To obtain optimal results from the sensors, you must **always place pan in the center of the cook zone**. Otherwise, the bottom of the pan is heated unequally and the food inside the pan may burn.



- **PLACE MAXIMUM ONE PAN PER COOK ZONE.**

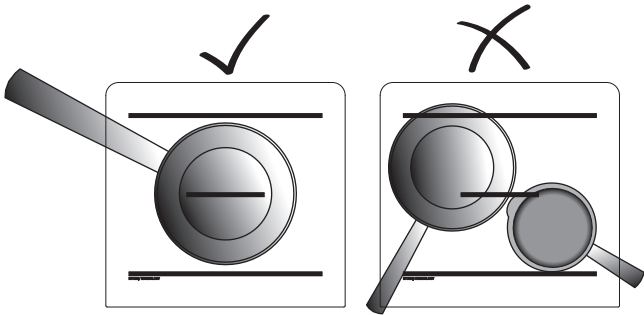

- **ALWAYS PLACE PAN IN THE CENTER OF A COOK ZONE.**

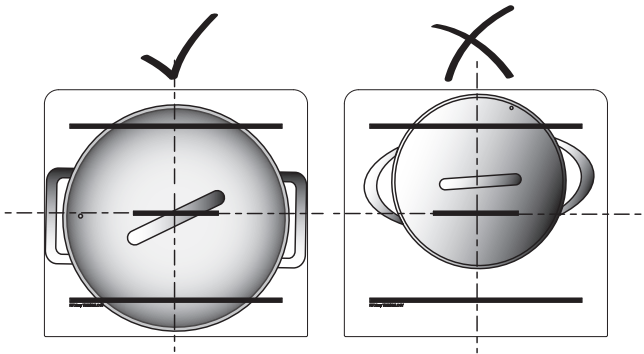

- **PAN MUST NOT COVER MORE THAN ONE COOK ZONE ON A DUAL/QUAD OR ON TWO SINGLE UNITS.**

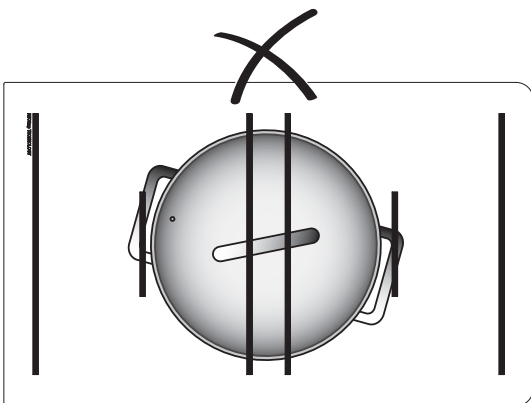

Display and Control Quick Reference

Note: Hold mode and Temperature function are not available for Wok Models

<p>Temperature, °C or °F</p> <ul style="list-style-type: none"> To set °C or °F, press down knob while connecting unit to power outlet. Turn knob to select P2 option on display. Click knob 1 time (1x) to confirm. Turn knob to select °C or °F and click knob 1x to confirm. To return to cook/hold mode, click and hold knob until other icons are shown on display. 	<p>Timer, Minutes</p> <ul style="list-style-type: none"> After selecting temperature or power level, double click knob to switch to Timer Mode. Turn knob to select time in minutes. Click knob 1 time (1x) to confirm and start count-down.
<p>Error: Overheated Unit!</p> <p>Error: Call for Service. Error Code on Display</p>	<p>°C</p> <p>°F</p> <p>Min</p>
<p>Hold Mode, Set Temperature</p> <ul style="list-style-type: none"> Turn knob to select temperature. To lock / unlock at selected temperature, click and hold down knob for 2 seconds. 	<p>LOCK</p> <p>LOCK</p> <p>LOCK</p>
<p>Turn Unit ON</p> <ul style="list-style-type: none"> Click knob 1 time <p>Turn Unit OFF</p> <ul style="list-style-type: none"> Turn knob to the lowest power or lowest temperature. When LED ring is flashing, turn knob slightly to turn unit off. 	<p>Cook Mode, Power Level from 1 to 12</p> <ul style="list-style-type: none"> Turn knob to select power level. To lock / unlock at selected power level, click and hold knob for 2 seconds.
<p>Control Knob</p> <p>TURN</p> <ul style="list-style-type: none"> Turn knob to select temperature / power / option. <p>CLICK</p> <ul style="list-style-type: none"> 1 time (1x) to switch from Cook to Hold mode or to confirm selection. double (2x) to switch to Timer function and hold for 2 seconds to lock or unlock unit. 	<p>LED ring</p> <ul style="list-style-type: none"> Lights up during power output. Flashes when waiting for operator input.

Control

TURN UNIT ON

Click knob and turn to select power level.

LED RING

- The LED ring flashes if operator input is needed.
- The LED ring lights up continuously during cooking or holding.

SWITCHING BETWEEN COOKING AND HOLDING MODES

Holding mode is not available for INSTINCT Wok.

1. During operation, click knob once. The LED flashes.
2. While watching the display, turn knob clockwise or counter-clockwise to activate Power Level Mode or Hold-Mode.
3. Click knob again to confirm selection.

SETTING POWER LEVEL (1 TO 12) AND LOCK/UNLOCK

1. In Power Level Mode, turn knob clockwise to choose power level:
 - Power level (1) = lowest power
 - Power level (12) = highest power
2. To lock power at set level, press down knob until the word "LOCK" on the display lights up. This takes 2 seconds.
3. To unlock, press down knob again until the word "LOCK" on the display goes dark. This takes 2 seconds.

Power Level Settings

The Power Diagrams (below) show that the difference in power output between two higher power levels is much larger than that between two lower power levels.

This power level and output relationship gives you a fine simmer-rate control in the low power range, and an instant response in the high power range.

POWER DIAGRAM 1: POWER LEVEL 0 TO 12

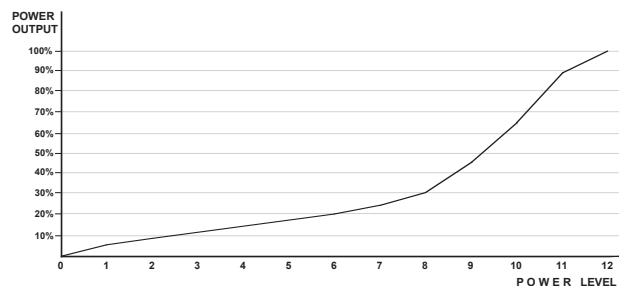

The settings from (1) to (9) span the lower 50% of the total Power Output; the settings from (10) to (12) cover the 50% to 100% output range.

SELECTING HOLD TEMPERATURE AND LOCK/UNLOCK

1. In Hold-Mode, turn knob until the desired temperature is shown on the display.
2. Leave the knob for approximate 5 seconds, the display will show the actual detected temperature.
3. To lock temperature at set level, press down knob until the word "LOCK" on the display lights up. This takes 2 seconds.
4. To unlock, press down knob again until the word "LOCK" on the display goes dark. This takes 2 seconds.

SETTING THE TIMER

The timer function can be set for both Cooking or Holding Modes.

1. After setting power level or temperature, double click the knob to switch to Timer Mode.
2. Turn knob to set the timer from minimum 1 minute to maximum 240 minutes. The LED ring will flash.
3. Click knob 1 time to confirm and start the count-down.
4. Note when using Hold-Mode with Timer, the display will show alternately the actual temperature and the count-down.
5. After the set time is elapsed, the appliance will sound a beeping signal and the unit will automatically shut down if the operator takes no action.

TURNING OFF

When in Cook or Hold Mode, turn knob to go to the lowest power level or lowest temperature.

When LED ring is flashing, turn knob slightly to turn off the appliance.

When the unit is switched off, a  appears in the display.

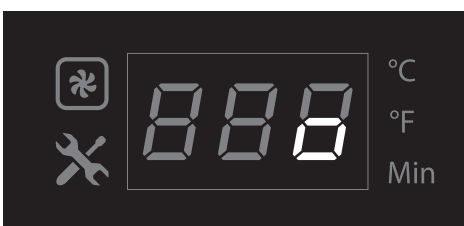

Additional Settings

Additional settings are available to reduce power level, and to set display to °C or °F.

To activate the additional settings:

1. Press down knob while connecting unit to power outlet.
2. Then turn knob to select setting P1 or P2:
 - P1 = Reduce nominal max power from 100% to 25%
 - P2 = Change temperature from °C to °F (function not available on Wok models)
 - P3 = Shows the actual Firmware number.
 - P4 = Enable / Disable buzzer (timer function)
3. Click knob 1 time (1x) to confirm selection.
4. In P1, turn knob to select power. In P2, turn knob to select °C or °F. In P4, turn knob to select "on" or "off"
5. Click knob 1 time (1x) to confirm selection.
6. To leave the special setting function, keep pressing down the knob until the normal cooking or hold mode is shown on display.

Automatic Pan Detection, No Pan No Heat

When a temperature or a power level is selected, the appliance supplies energy only when a pan is placed in the cook zone.

When you remove the pan from the cook zone, the appliance stops power output immediately. The power output resumes, when the pan is placed back on the cooking zone.

Notice

Switch off the cook-top by means of the control. Do not rely on the Pan Detection as the ON-OFF control.

Notice

Pan with a bottom diameter smaller than 12cm or 5" is not detected by the system.

When Appliance Is Idle

When the induction appliance is not in use, always turn off the appliance.

Notice

Switch the appliance off if you take the cookware away for a while. This will prevent the heating process to start automatically and unintentionally when a pan is placed back on the heating area. If any person needs to use the induction appliance, he/she will have to turn the appliance ON intentionally.

Decommissioning

Procedure if the device is not needed for a long time.

1. Switch off the device on the knob.
(See Section 3 Turning Off)
2. Disconnect the device from the mains.

DANGER

If the plug is not safely accessible, the device must be switched off at the main circuit breaker.

Section 4 Maintenance

MAINTENANCE SAFETY—DISCLAIMER

DANGER

It is the responsibility of the equipment owner to perform a Personal Protective Equipment Hazard Assessment to ensure adequate protection during maintenance procedures.

Warning

A good maintenance of the appliance requires regular cleaning, care and servicing. The site-supervisor and the operator must ensure all components relevant to safety are in perfect working order at all times.

NOTE: Cleaning tools and supplies are not provided.

DANGEROUS ELECTRICAL VOLTAGE

DANGER

Do not open the appliance. Maintenance and servicing work other than cleaning as described in this manual must be done by an authorized service personnel.

DANGER

If any part of the appliance is cracked or broken, **turn off directly the appliance and immediately disconnect the appliance from supply**. Only if it is possible and safe, disconnect the equipment from main power supply. Do not touch any parts inside the appliance.

Disconnect electric power at the main power disconnect for all equipment being serviced.

Failure to disconnect the power at the main power supply disconnect could result in serious injury or death. The knob DOES NOT disconnect incoming power.

Contact an authorized service agency for assistance.

MAINTENANCE SAFETY—CLEANING

Warning

Never use a high-pressure water jet for cleaning or hose down or flood interior or exterior of the equipment with water. Ensure that no liquid can enter into the equipment.

Warning

Allow heated equipment / glass surface to cool down before attempting to clean, service or move.

Warning

When cleaning the exterior, care should be taken to avoid front power switch and the electrical cords. Keep water and cleaning solutions away from these parts.

Caution

Do not use caustic cleaners on any part of the equipment. Use mild, non abrasive soaps or detergents, applied with a sponge or soft cloth.

Caution

Ensure to remove all residues of cleaning agents from the cooking surfaces. Use a clean moist cloth to wipe off any such surfaces.

Caution

Using commercial cleaning fluids or chemicals: Read the directions for use and precautionary statements before use. Pay attention to the concentration of cleaner and the length of time the cleaner remains on the food-contact surfaces or equipment surfaces.

Notice**Inspect and Clean Fresh Air Intake Filter**

We strongly recommend using air intake filters in all installations to protect the equipment from grease particles. A dirty, blocked air intake filter blocks the air vent and can cause damages to the electronic components. Inspect, clean or replace the air intake filters at least once a week or as often as necessary.

⚠ Warning**Inspect Silicone Seal**

When the silicone seal is broken, water penetration could cause the appliance to fail, and any malfunction could cause personal harm.

PERSONAL PROTECTION**⚠ DANGER**

All utilities (gas, electric, water and steam) must be OFF to all equipment and locked out of operation according to national/regional, as well as company approved practices during installation, maintenance and servicing. Always allow appliance to cool.

⚠ DANGER

Use appropriate safety equipment during installation, maintenance and servicing.

⚠ DANGER

Never stand, sit, or lean on the equipment! They are not designed to hold the weight of an adult, and may collapse or tip if misused in this manner.

⚠ DANGER

To avoid cardiac pacemaker malfunction, consult your physician or pacemaker manufacture about effects of electromagnetic field on your pacemaker.

⚠ DANGER

Replace defective power cables immediately by an authorized service agency.

⚠ Warning

Markings and warning labels mounted directly on the equipment must be observed at all times and kept in a fully legible condition.

⚠ Warning

Risk of burns from high temperatures. You may get burnt if you touch any of the parts during operation. Surfaces close to the cooking area including side panels may get hot enough to burn skin. Use extreme caution to avoid coming in contact with hot surfaces or hot grease. Wear personal protective equipment.

⚠ Caution

Use caution when handling metal edges of all equipment.

Daily Cleaning and Maintenance

GLASS CLEANING

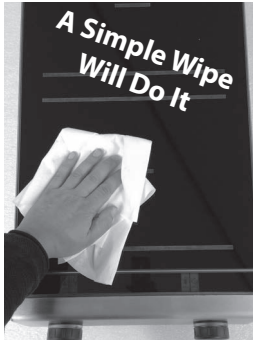

NOTE: The cleaning of Ceran® glass is identical to cleaning other similar glass surfaces. You may use any regular glass cleaning products available from a hardware store.

You may use a razor blade scraper or a non-scratching sponge to remove tough residues. When scraping, place your razor blade scraper at an angle of about 20° to 30° from the glass. Then wipe clean the glass with a cleaning product.

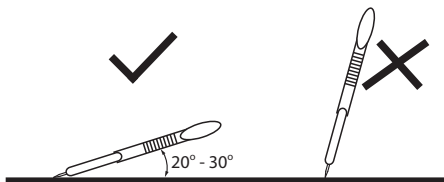

STAINLESS STEEL

1. Clean the stainless steel surface using a soft cloth with a mild detergent and/or a food-safe liquid cleaner designed to clean stainless steel.
2. Wipe dry with a soft clean cloth.

VISUAL INSPECTION OF SILICONE SEAL

Inspect the silicone seal around the glass perimeter. Call for service immediately if you notice:

- Cracks on the silicone seal.
- The silicone seal comes away from the glass/housing or moves when you press down on the seal.

Weekly Cleaning and Maintenance

AIR INTAKE FILTER

1. The air intake filter is located on the bottom of the appliance. To remove, slid out the filter from the holder.

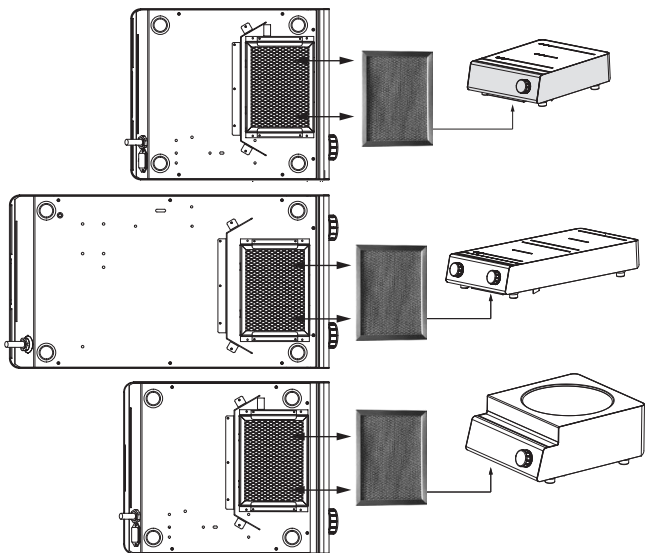

2. The filter is dishwasher-safe.

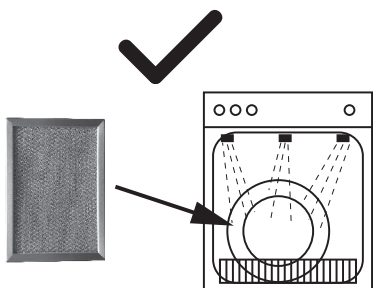

3. **MUST DRY** the filter before putting it back into the holder.

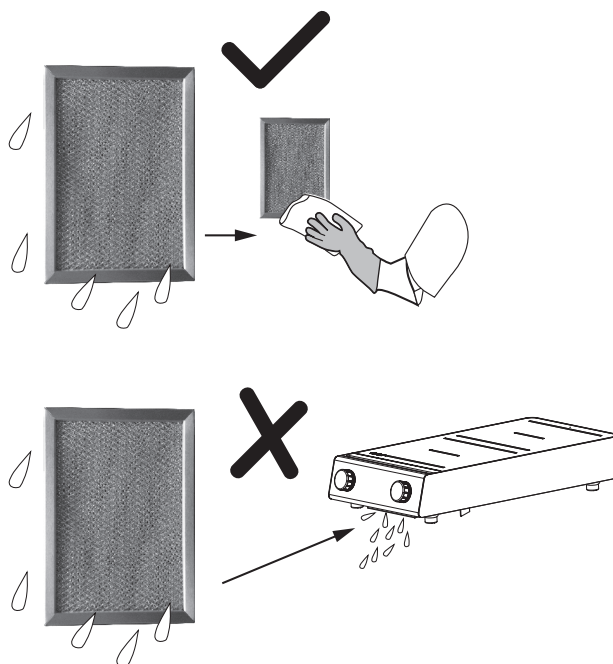

In case of insufficient cleaning of the device, the warranty expires.

Yearly Maintenance

Best Practice: Have the induction appliance examined once a year by an authorized technician.

General Maintenance Tips:

- Inspect all induction cookware to ensure proper condition.
- Have an authorized technician to inspect and ensure that:
 - All ventilation fans are working properly.
 - No grease built-up around the equipment and air filter.

Section 5 Troubleshooting

DANGEROUS ELECTRICAL VOLTAGE

⚠ DANGER

If any part of the appliance is cracked or broken, **turn off directly the appliance and immediately disconnect the appliance from supply**. Only if it is possible and safe, disconnect the equipment from main power supply. Do not touch any parts inside the appliance.

Disconnect electric power at the main power disconnect for all equipment being serviced.

Failure to disconnect the power at the main power supply disconnect could result in serious injury or death. The power switch DOES NOT disconnect all incoming power.

Contact an authorized service agency for assistance.

⚠ DANGER

Do not open the appliance. Maintenance and servicing work other than cleaning as described in this manual must be done by an authorized service personnel.

⚠ Warning

Markings and warning labels mounted directly on the equipment must be observed at all times and kept in a fully legible condition.

NOTE: If a problem arises during operation of your induction appliance, follow the Troubleshooting Charts before calling service. Routine adjustments and maintenance procedures are not covered by the warranty.

Common Problems

One or more of the following conditions may affect the function or cause the induction equipment to fail:

- Using unsuitable cookware such as non-induction pans, oversized pans, or damaged

pans.

- High ambient temperature.
- Inadequate ventilation causing hot air to re-enter through the air intake slots.
- Dirty air intake filter.
- Empty pan is left on the hob when the appliance is ON.

Symptoms

- When a malfunction occurs, the appliance may be in one of the following states:
 - The appliance switches off immediately.
 - The appliance continues to operate in a power reduction mode.
 - The appliance continues to operate normally.

- NOTE:

The cooling fan starts when the ambient temperature in the control area exceeds 55°C [130°F].

At heat sink temperature higher than 70°C [160°F], the controller automatically reduces power to keep the appliance in normal operating conditions.

Boil Test

To test the quality of a pan for induction cooking, perform a boil test.

This test is not applicable to griddles and braising pans. NEVER heat any cooking pan on a griddle plate or in a braising pan.

(Test for 3.5kW or 5.0kW Induction Coil)

Perform a boil test to verify the performance of a pan for induction cooking.

- Add one liter of cold water into the pan (optimal when use pan with bottom diameter of 24cm) and bring it to boil. Compare the total boil time to the guideline below:
 - 3.5kW Coil, approx. 140 seconds
 - 5.0kW Coil, approx. 85 seconds

If time to boil exceeds the above guideline, then the pan is not suitable for achieving optimal efficiency. Please contact your supplier to purchase suitable induction pans.

If the induction appliance does not function as expected despite using quality induction pans, refer to the troubleshooting charts.

Dangers avoidance in case of accidents or malfunctions

To avoid hazards in the event of a malfunction or accident related to the device, proceed as follows.

1. Disconnect the power supply from the circuit breaker provided for the device.
2. Disconnect the mains plug of the affected device to prevent it from being switched on again.

DANGER

If the plug is not safely accessible, the device must be switched off at the main circuit breaker.

Troubleshooting Without Error Code

Symptom	Possible Cause	Action
Pan does not heat up on glass-top. Digital display is OFF (dark).	No power supply. Unit is turned off. Defective unit.	Check incoming power supply (Example, power cable plugged into the wall socket). Check kitchen main fuse box. Turn control knob to an ON-position. Only if possible and safe, disconnect the appliance from the power supply. Contact an authorized service agency. (1) Use a suitable pan with bottom diameter larger than 12cm[5"]. Move the pan to the center of the hob.
Pan does not heat up and no pan symbol is on. (Not applicable to griddles or braising pans.)	Pan is too small. Pan is not placed in the center of the hob; pan is not detected by sensor. (2) Unsuitable pan. Defective unit.	Select only induction-ready cookware. Only if possible and safe, disconnect the appliance from the power supply. Contact an authorized service agency. (1) Verify that air vents are not obstructed. Ensure the fresh air filter is clean.
Poor heating, LED ring is ON	Air-cooling system is obstructed. Unsuitable pan. (Not applicable to griddles or braising pans.) Ambient temperature is too high. The cooling system is not able to keep the appliance in normal operating conditions. One phase is missing (for equipment with three phase supply only). Reduced Power adj. Defective unit.	Select various induction-ready cookware for induction cooking. Then compare the results. Verify that no hot air is taken in by the fan. Reduce the ambient temperature. The intake air temperature must be lower than 40°C [104°F].
Appliance does not react to control knob positions Overheated unit symbol is ON, fan is working	Defective control knob. Air-cooling system is obstructed. Internal fan is dirty.	Check incoming power supply (Example, power cable plugged into the wall socket). Check kitchen main fuse box. Check Additional Setting "P1". Only if possible and safe, disconnect the appliance from the power supply. Contact an authorized service agency. (1) Only if possible and safe, disconnect the appliance from the power supply. Contact an authorized service agency. (1) Verify that air vents are not obstructed. Ensure the fresh air filter is clean. Contact an authorized service agency.







Symptom	Possible Cause	Action
Overheated unit symbol is ON, fan does not work	Defective fan or fan control.	Only if possible and safe, disconnect the appliance from the power supply. Contact an authorized service agency. (1)
Overheated unit symbol is ON	Overheated induction coil; cooking area is too hot. Overheated pan. Pan is empty.	Switch the appliance off. Safely remove pan. Wait until the appliance has cooled down before turning it ON.
Small metallic objects (e.g. spoon) are heated up in the cook zone.	Pan detection function is defective.	Only if possible and safe, disconnect the appliance from the power supply. Contact an authorized service agency. (1)

- (1) **▲ DANGER** If the plug is not safely accessible, the device must be switched off at the main circuit breaker.
- (2) The appliance switches off immediately.



Troubleshooting — Error Code

Error Code (Display)	Problem	Action
	Normal Operation.	Normal Operation.
E01	Unsuitable induction cooking pan. Internal wiring/coil connection malfunction. (2)	Check pan material. Contact an authorized service agency.
E02	Unsuitable induction cooking pan. Coil overcurrent. (2)	Check pan material. Contact an authorized service agency.
E03 + 	Air-cooling system obstructed. Fan malfunction. Heat sink overheated. (2)	Let appliance cool down. Verify that air vents are not obstructed. Check and clean air filter. Contact an authorized service agency.
E04 + 	Overheated cook zone. Overheated pan detected. Sensor failure.	Let appliance and/or pan cool down. Check pan material. Verify that air vents are not obstructed. Check and clean air filter. Contact an authorized service agency.
E41, E42, E43, E44, E45, E46	Overheated or defective sensor. (2) NOTE: Errors E41 to E46, griddles and braising pans may continue to operate.	Let appliance cool down. Verify that air vents are not obstructed. Check and clean air filter. Contact an authorized service agency.
E06, E30 + 	Ambient temperature too high (the cooling system is not able to keep the induction appliance in normal operating conditions). Internal component overheated. (2)	Let appliance cool down. Verify that air vents are not obstructed. Check and clean air filter. Verified that no hot air is taken in by the fan. Reduce the ambient temperature. The intake air temperature must be lower than 40°C [104°F]. Contact an authorized service agency.
E07	Phase failure.	Check the fuses belonging to the socket to which the device is connected. Contact an authorized service agency.
E08	Over- or undervoltage.	Contact an authorized service agency.
E29	Generator component failure. (2)	Contact an authorized service agency.
E47	Warning from overheated pan / cooking empty sensor or coil connection failed. (2)	Contact an authorized service agency. Let equipment / pan cool down. Check pan material. Check food in the pan or empty pan.
E21 + 	Sensor error from heat sink. Ambient temperature beyond normal operating range. (2)	Verify that air vents are not obstructed. Check air filter. Reduce ambient temperature. Contact an authorized service agency.



Error Code (Display)	Problem	Action
E24 + 	Sensor error from CPU. Board overheated. Ambient temperature beyond normal operating range. (2)	Verify that air vents are not obstructed. Check air filter. Reduce ambient temperature. Contact an authorized service agency.

- (1) **▲ DANGER** If the plug is not safely accessible, the device must be switched off at the main circuit breaker.
- (2) The appliance switches off immediately.





powered by
INDUCS

GARLAND
1177 KAMATO ROAD, MISSISSAUGA, ONTARIO, CANADA, L4W1XA

888-442-7526
WWW.GARLAND-GROUP.COM



WELBILT®
Bringing innovation to the table

WWW.WELBILT.COM

Welbilt provides the world's top chefs, and premier chain operators or growing independents with industry leading equipment and solutions. Our cutting-edge designs and lean manufacturing tactics are powered by deep knowledge, operator insights, and culinary expertise.

All of our products are backed by KitchenCare® – our aftermarket, repair, and parts service.

- ▶ CLEVELAND
- ▶ CONVOTHERM®
- ▶ DELFIELD®
- ▶ FITKITCHEN™
- ▶ FRYMASTER®
- ▶ GARLAND
- ▶ KOLPAK®
- ▶ LINCOLN
- ▶ MANITOWOC®
- ▶ MERCOC®
- ▶ MERRYCHEF®
- ▶ MULTIPLEX®

©2017 Welbilt Inc. except where explicitly stated otherwise. All rights reserved. Continuing product improvement may necessitate change of specifications without notice.

