

beurer

MG 79 Massage Gun Sensitive



EN Deep Tissue Massager
Instructions for use

CE

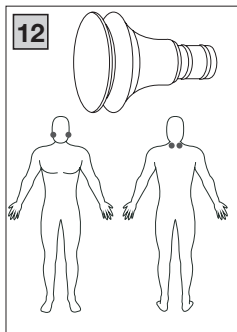
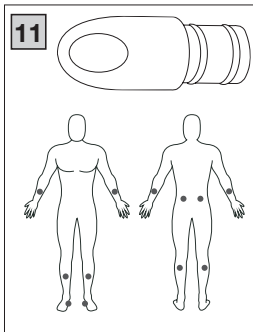
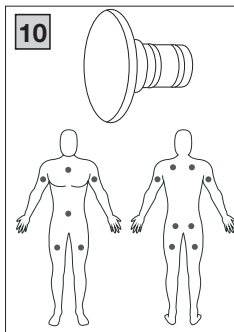
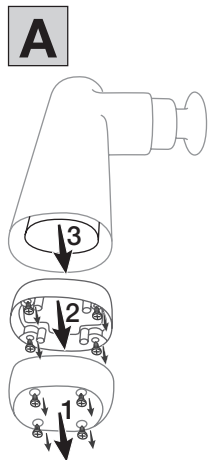
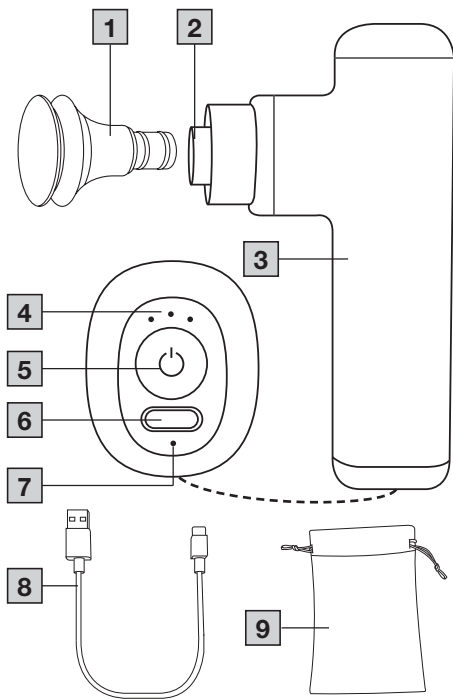



Read these instructions for use carefully and keep them for later use. Make them accessible to other users and note the information they contain.

CONTENTS

1. Warnings and safety notes.....	4	6. Usage	8
2. Included in delivery	6	6.1 Initial use/charging the battery.....	8
3. Intended use	6	6.2 Selecting/changing the attachment.....	8
4. Signs and symbols.....	6	6.3 Switching on the device/selecting the intensity level	8
5. Device description.....	7	7. Cleaning and maintenance	9
5.1 Deep Tissue Massager	7	8. What if there are problems?	9
5.2 Attachments.....	7	9. Disposal	9
		10. Technical specifications	10
		11. Guarantee / Service	10

⚠ WARNING

- The device is only intended for domestic/private use, not for commercial use.
- This device may be used by children over the age of 8 and by people with reduced physical, sensory or mental skills or a lack of experience or knowledge, provided that they are supervised or have been instructed on how to use the device safely, and are fully aware of the consequent risks of use.
- Children must not play with the device.
- Cleaning and user maintenance must not be performed by children unless supervised.

- If the mains connection cable of this device is damaged, it must be disposed of. If it cannot be removed, the device must be disposed of.
- Under no circumstances should you open or repair the device yourself. If you do so, it may no longer function correctly. Failure to comply will invalidate the guarantee.
- Do not insert any objects into the opening in the device or into the moving parts. Ensure that the moving parts can move freely at all times.
- Do not force or jam any part of your body, in particular your fingers, between the moving massage elements or their holders in the device.

1. WARNINGS AND SAFETY NOTES

⚠ WARNING

Do not use the device if you suffer from a medical abnormality or injury in the area to be massaged (e.g. slipped disc, open wounds).

- Do not use the device if you wear a pacemaker.
- Do not use the device for massaging the area around the heart.
- Do not use the device on swollen, burnt, inflamed or injured skin and body parts.
- Do not use the device on cuts, capillaries, varicose veins, acne, couperose, herpes or other skin diseases.
- Do not use the device during pregnancy.
- Do not use the device on your head or face (e.g. on the eyes), except for the jaw muscles, provided you do not have any



dental implants or general dental treatments.

- Do not use the device on the larynx, in the pubic area or other particularly sensitive body parts.
- Do not use the device on the spine or directly on the bone.
- Do not use the device while sleeping.
- Do not use the device on animals.
- Do not use the device after the consumption of medicines or alcohol (reduced cognition!).
- Do not use the device in a vehicle.

You should consult your doctor before using the device, especially

- if you suffer from a severe illness,
- if you suffer from thrombosis,
- if you suffer from diabetes,
- if you are suffering from pain, the cause of which is unknown.

⚠ WARNING

- Danger of suffocation! Keep packaging material away from children.
- Danger of suffocation! Keep the attachments away from children.
- Risk of electric shock! Make sure that the device does not come into contact with water or other liquids.
- Risk of electric shock! Never pick up a device that has fallen into water.
- Children must be supervised at all times whilst using the device.
- There may be a risk of fire if the device is used improperly or these instructions for use are ignored.
- Never leave the device unattended when it is in operation, particularly if there are children nearby.
- Never operate the device underneath a cover, such as a blanket, pillow, etc.
- Never use the device near petrol or other highly flammable substances.
- Only operate the device in dry indoor areas.
- Never operate the device in the bath or a sauna.

⚠ IMPORTANT

- Before use, ensure that the device and the attachments show no visible damage. If you have any doubts, do not use the device and contact your retailer or the specified Customer Services address.
- Never open the housing.
- Keep the device away from pointed or sharp objects.
- If the device has been dropped or has suffered any other damage, it must no longer be used.
- Switch off the device after every use and before cleaning.
- Never use the device for more than 15 minutes (risk of overheating). Allow the device to cool down for at least 15 minutes before using it again.

- Only use the device with the supplied accessories.
- Protect the device and the attachments from knocks, dust, chemicals, drastic changes in temperature, electromagnetic fields and nearby sources of heat (ovens, heaters).

⚠ WARNING

Repairs

- Never attempt to repair the device yourself!
- Only specialist personnel may perform repairs on electrical devices. Under no circumstances should you open or repair the device yourself. If you do so, it may no longer function correctly. Improper repairs may put users in significant danger. For repairs, please contact Customer Services or an authorised retailer. Failure to comply will invalidate the guarantee.

⚠ WARNING

Notes on handling batteries

- **Risk of explosion! Risk of fire!** Failure to comply with the points mentioned can result in personal injury, overheating, leakage, venting, breakage, explosion, or fire.
- Always use the correct or supplied charging cable/charger/mains adapter for charging.
- Avoid continuous charging or overcharging. Unplug the charger when charging is complete.
- To charge the device, please use an adapter that matches the input specifications for the device (input: 5.0 V, 1.0 A).
- Charge the device under supervision, paying attention to any heat generated, deformation, or release of gases. If in doubt, stop charging.
- If batteries/charging cables/chargers are defective, stop using them and dispose of them properly as soon as possible (see chapter on disposal).

- Do not throw the device or batteries into a fire.
- Never forcibly discharge, heat, disassemble, open, crush, deform, encapsulate, modify, or knock the device or batteries.
- Never short-circuit batteries or the connections of the battery-powered device.
- Protect the device or batteries from direct sunlight, rain, heat, and water.
- Exposure of batteries to an environment with extremely high temperatures or an extremely low air pressure may result in explosion or leakage of flammable liquids and gases.
- If fluid from a battery comes into contact with your skin or eyes, wash the affected areas with water and seek medical assistance.

NOTICE

- This device contains a battery that is not replaceable. Once a battery has reached the end of its service life, the device must be disposed of properly (see chapter on disposal).

2. INCLUDED IN DELIVERY

Check that the exterior of the cardboard delivery packaging is intact and make sure that all contents are present. Before use, ensure that the Deep Tissue Massager and the attachments show no visible damage.

- 1 Deep Tissue Massager
- 3 attachments
- 1 USB-C cable
- 1 storage bag
- 1 copy of these instructions for use

3. INTENDED USE

⚠ WARNING

Only use the Deep Tissue Massager with the attachments included in delivery. The Deep Tissue Massager and the attachments are

not medical devices, but massage treatment devices. The Deep Tissue Massager is only suitable for personal use, not for medical or commercial purposes. The device may only be used for the purpose for which it is designed and in the manner specified in the instructions for use. Any form of improper use can be dangerous. The manufacturer is not liable for damage resulting from improper or incorrect use. Do not use the Deep Tissue Massager if one or several of the listed warnings and safety notes applies to you. If you are unsure whether the Deep Tissue Massager is suitable for you, please consult your doctor.

4. SIGNS AND SYMBOLS

The following symbols are used on the device, in these instructions for use, on the packaging and on the type plate for the device:

⚠ DANGER

Indicates an imminent danger. If it is not avoided, it will result in death or serious injury.

⚠ WARNING

Indicates a potentially impending danger. If it is not avoided, there is a risk of death or serious injury.

⚠ CAUTION

Indicates a potentially impending danger. If it is not avoided, slight or minor injuries may result.

NOTICE

Indicates a potentially harmful situation. If it is not avoided, the system or something in its vicinity may be damaged.



Read the instructions

	Product information Note on important information
	CE labelling This product meets the requirements of the applicable European and national directives.
	For indoor use only.
	Manufacturer
	Do not use the Deep Tissue Massager on people with implanted electrical devices (e.g. a pacemaker)
	Do not dispose of batteries containing harmful substances with household waste
	Separate the product and packaging elements and dispose of them in accordance with local regulations.
	The products demonstrably meet the requirements of the Technical Regulations of the EAEU.
	Conformity assessed marking for the United Kingdom
	Marking to identify the packaging material. A = material abbreviation, B = material number: 1–7 = plastics, 20–22 = paper and cardboard
	Disposal in accordance with the Waste Electrical and Electronic Equipment EC Directive – WEEE
	Polarity of DC power connection
	Direct current The device is suitable for use with direct current only
	Importer symbol

5. DEVICE DESCRIPTION

5.1 Deep Tissue Massager

The associated drawings are shown on page 2.

1 Attachment 3 different attachments are available
2 Attachment connection
3 Handle
4 Intensity indicator (3 LEDs) 3 LEDs, starting from left to right
5 ON/OFF button
6 USB-C cable connection
7 Battery level indicator (1 LED) <u>During operation:</u> LED lights up white = battery level 25–100% LED flashes red = battery level 0–25% <u>During charging:</u> LED flashes white = battery charging LED lights up white = battery fully charged
8 USB-C cable
9 Storage bag

5.2 Attachments

10 Flat head Best suited for treating large areas on the entire body (e.g. the thigh).
11 Spiral head Best suited for treating deep muscle tissue and for targeted spot massages (e.g. on the sole of the foot).
12 Air cushion head Best suited for sensitive parts of the body (e.g. the neck).

6. USAGE

6.1 Initial use/ charging the battery

- i** The massage must feel pleasant at all times. Start the treatment at the lowest intensity level and then increase it according to your preferences if necessary. A slight haematoma may well occur – this is a positive therapeutic effect as the use of the device can selectively encourage your blood flow. In isolated cases, areas of redness may also occur on the skin. If you experience excessive skin irritation, stop using the device and consult a doctor. Depending on the level of tension, a treatment time of approx. 10 minutes is recommended for the desired area (neck, shoulders, back, arms, buttocks or legs).

Before using the Deep Tissue Massager for the first time, charge it for a minimum of 1:30 hours. To do so, proceed as follows:

1. Remove all packaging material from the device.
2. Connect the supplied USB-C cable to the Deep Tissue Massager. The connection for the USB-C cable **6** is located on the underside of the handle.

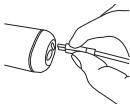

3. Connect the USB-C cable to a USB-C mains plug (not included in delivery). Insert the USB-C mains plug into a suitable socket. The battery level indicator **7** shows the current battery level.

Battery level indicator **7** flashes white = battery charging

Battery level indicator **7** lights up white = battery is fully charged

4. As soon as the battery level indicator **7** lights up white, remove the USB-C mains plug (not included in delivery) from the socket. The battery is now fully charged.

The battery will last for approx. 3 hours of operation when fully charged. As soon as the battery level indicator **7** starts to flash red, you must recharge the Deep Tissue Massager; otherwise it will automatically switch off.

6.2 Selecting/changing the attachment

Select the appropriate attachment before starting the massage. To change an attachment, proceed as follows:

1. Pull the existing attachment horizontally off the Deep Tissue Massager.

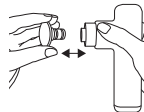

2. Slide your desired attachment firmly into the Deep Tissue Massager until you feel it click securely into place.

6.3 Switching on the device/ selecting the intensity level

- i** The Deep Tissue Massager comes with an automatic switch-off function. This means that the Deep Tissue Massager automatically switches off after a period of use of approx. 10 minutes.



1. Press and hold the ON/OFF button **5** for 2 seconds. The battery level indicator **7** starts to light up. The device is now in standby mode.
2. Briefly press the ON/OFF button **5** to switch on the device. The left LED of the intensity indicator **4** starts to light up. The massage starts at intensity level 1.
3. To switch between the intensity levels, briefly press the ON/OFF button **5**. The intensity indicator **4** shows the current intensity level.

Intensity level 1 (1700 rpm) →

Intensity level 2 (2450 rpm) →

Intensity level 3 (3200 rpm) →

Standby.

4. You can switch off the device at any time during use by pressing and holding the ON/OFF button  **5** (2 seconds). If you press the ON/OFF button  **5** again at the third intensity level, the device switches off. The device is in standby mode.

 If the device stops during use, this may be due to excessive pressure. Make sure that you do not exert too much pressure on the Deep Tissue Massager when using it.

7. CLEANING AND MAINTENANCE

Cleaning

WARNING

- Switch off the device each time before cleaning.
- Do not clean the device in the dishwasher.
- Clean the device only using a slightly damp cloth and a non-abrasive cleaning product. For hygienic cleaning, clean the attachments **10**/**11**/**12** with water and a non-abrasive cleaning product.
- Clean the device using only the methods specified. Under no circumstances may liquid enter the device.
- When using massage oils (recommended for attachment **10**/**11** only), ensure that all residue is completely removed and cleaned.
- Do not use the device or attachments again until all components are completely dry.

Care

If you do not plan to use the Deep Tissue Massager for a long period of time, we recommend that you store it in the original packaging in a dry environment, ensuring it is not weighed down by additional items.

8. WHAT IF THERE ARE PROBLEMS?

Problem	The Deep Tissue Massager stops during use.
Solution	Make sure that you do not exert too much pressure on the Deep Tissue Massager when using it. If you exert too much pressure, the device will stop briefly.

9. DISPOSAL

Battery disposal

When disposing of the device, you must first remove the battery from the device **A**. To do so, proceed as follows:

1. Remove the sticker from the lower part of the handle **3**.
2. Then loosen the four screws on the cover.
3. Remove the cover on the underside of the handle by loosening the plug connections on the circuit board.
4. Then remove the four screws on the holder which is in front of the battery.
5. Now remove the battery from the handle.
6. Then you can reattach the holder and the cover on the underside of the device using the screws.

Empty, completely flat batteries must be disposed of in specially designated collection boxes, at recycling points or at electronics retailers. You are legally required to dispose of the batteries.

The codes below are printed on batteries containing harmful substances:

Pb = battery contains lead
Cd = battery contains cadmium
Hg = battery contains mercury



Faulty or used batteries must be recycled in accordance with Directive 2006/66/EC and amendments thereto. Return the batteries and/or the device using the collection facilities provided.

For environmental reasons, do not dispose of the device in household waste at the end of its service life.

Dispose of the device at a suitable local collection or recycling point in your country. Dispose of the device in accordance with EC Directive Waste Electrical and Electronic Equipment (WEEE). If  you have any questions, please contact the local authorities responsible for waste disposal.

10. TECHNICAL SPECIFICATIONS

Mains operation: Input	5.0 V  1.0 A
Dimensions	Approx. 8.4 x 14.7 x 3.8 cm (without attachments)
Weight	Approx. 250 g (without attachments, without USB-C cable)
Battery: Capacity Nominal voltage Type designation	1100 mAh 7.4 V Lithium-ion

11. GUARANTEE / SERVICE

More information on the guarantee and guarantee conditions can be found in the guarantee leaflet supplied.



Beurer GmbH • Söflinger Str. 218 • 89077 Ulm, Germany • www.beurer.com
www.beurer-gesundheitsratgeber.com • www.beurer-healthguide.com



UK Importer: Beurer UK Ltd., Suite 16, Stonecross Place,
Stonecross Lane North, WA3 2SH Lowton, United Kingdom



102.18_MGT9_2025-10-27_03_IM2_BEU_EN