



MAKE A DIFFERENCE

Roof Rack

BXG.1069-S
(INSTALLATION INSTRUCTION)

ATTENTION • Please verify all parts are present and read instructions carefully before starting installation.
Please feel free to contact your distributor if you have any kind of question about your purchase.

CONTENTS



Qty	Part Name	Size(mm)	Picture
2	Button Bolts	M8×25	
34	Button Bolts	M8×20	
4	Hex Head Flange Bolts	M8×20	
8	Button Bolts	M6×10	
38	Flat Washer	M8×20×1.5	
8	Flat Washer	M6×12×1.5	
8	Flange Hex Lock Nuts	M8	
8	Tee Sliding Slot Nuts	M6	
2	EVA	70×37×2	
2	EVA	68×28×2	
2	Mounting Brackets Covers Rubber Mat	79×15×6	
2	Nylon Round Spacer	M8×20×7	
2	Rivet Nut Plate	M8	

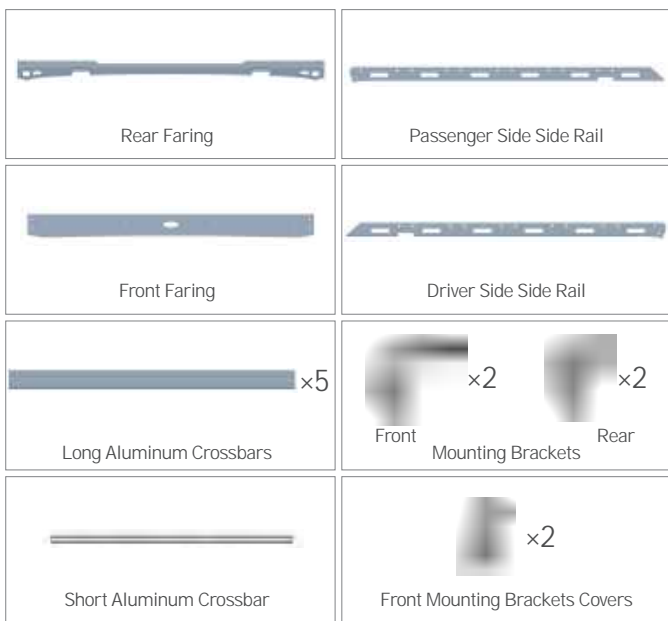

TOOLS REQUIRED

◆ Drive Ratchet Handle

◆ 4mm, 5mm Hex Bit Socket

To view online instruction, please scan the QR code.



3 INSTALLATION INSTRUCTION

Step 1

Short Aluminum Crossbar Assembly.

- (8) M6x10 Button Bolts
- (8) M6x12x1.5 Flat Washers
- (8) M6 T-nuts

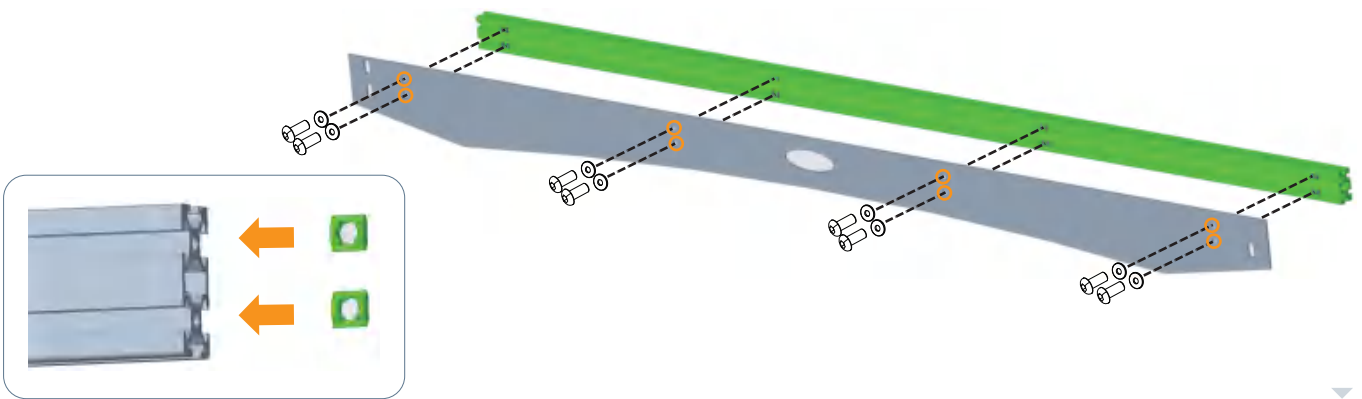

Step 2

Front & Rear Farings Assembly. Repeat this step on the other side of the roof rack. **Do not fully tighten to allow adjustability.**

- (8) M8x20 Button Bolts
- (8) M8x20x1.5 Flat Washers
- (8) M8 Flange Hex Lock Nuts

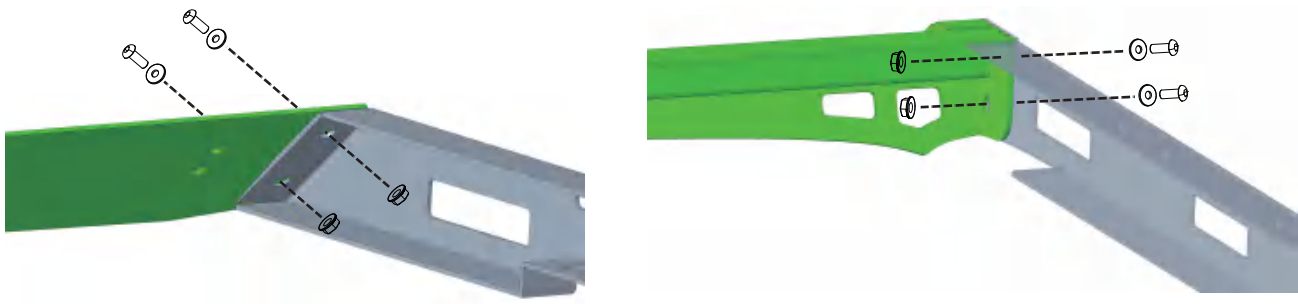

Step 3

Secure the mounting brackets to the side rails.

Do not fully tighten to allow adjustability. Repeat this step on the other side of the roof rack.

- (4) M8x20 Hex Head Flange Bolts
- (4) M8x20x1.5 Flat Washers
- (2) M8 Rivet Nut Plates

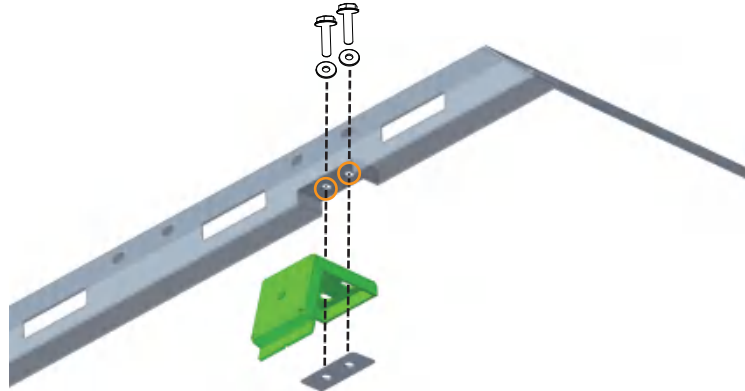

Step 4

Snap the Rubber Mat into the front mounting brackets. Stick the EVA to the front mounting brackets covers and rear mounting brackets.

- (2) 79*15*6 Rubber Mat
- (2) Front Mounting Brackets
- (2) EVA 70*37*2
- (2) Front Mounting Brackets Covers
- (2) EVA 68*28*2
- (2) Rear Mounting Brackets



Long Aluminum Crossbar Assembly.

Repeat this step on the other position of the roof rack. **Do not fully tighten to allow adjustability.**

- (20) M8x20 Button Bolts
- (20) M8x20x1.5 Flat Washers

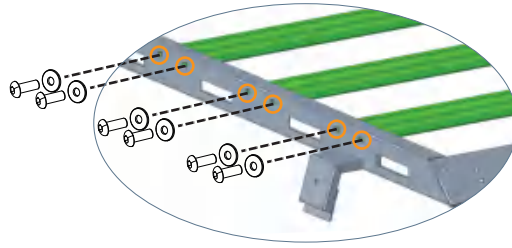

Secure the rear mounting brackets to the vehicle. **Do not fully tighten to allow adjustability.**

- (4) Factory Bolts

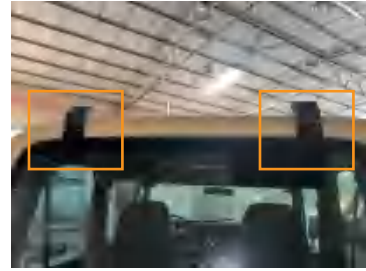

Lift the roof rack to the roof of vehicle and adjust it to the desired location. **Do not fully tighten to allow adjustability.**

- (4) M8x20 Button Bolts
- (4) M8x20x1.5 Flat Washers

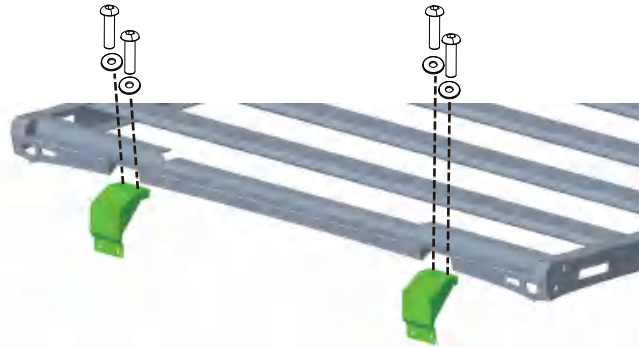

Install the mounting bracket covers.

At last, tighten up all bolts.

- (2) M8x25 Button Bolts
- (2) M8x20x7 Nylon Round Spacer
- (2) M8x20 Button Bolts
- (2) M8x20x1.5 Flat Washers

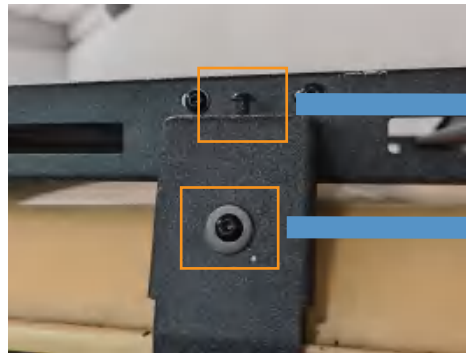

Tighten the upper bolt first, and then tighten the lower bolt.

The installation is complete. We hope you enjoy a wonderful off-road life with this quality Hooke Road product!

