

NOTICE D'UTILISATION ET D'INSTALLATION

Installation and operating manual - Gebruiks- en installatiehandleiding - Manual de utilización e instalación - Manual do Usuário e da Instalação - Instrukcja obsługi i montażu - Инструкция по пользованию и установке

TATOU DIGITAL

PANNEAU RAYONNANT VERSIONS HORIZONTALES ET VERTICALES

Radiant panel heater - Horizontal and vertical
Warmtestraalradiator - Horizontale en verticale modellen
Emisor radiante - Versões horizontales y verticales
Emissor radiante - Versões horizontais e verticais
Promiennik elektryczny - wersja POZIOMA i PIONOWA
теплоизлучающая панель
Существует вертикальная и горизонтальная версии прибора



F
GB
NL
SP
P
PL
RU

GUIDE À CONSERVER PAR L'UTILISATEUR

Manual must be kept by end user
Gids te bewaren door de gebruiker
Guía que deberá ser conservada por el usuario
Guia a conservar pelo usuário
Instrukcja obsługi

Рекомендуется сохранение данной инструкции
пользователем



Contents

Warning	28
Installation	
Preparing the installation of the device.....	29
Unlocking the device's hanging frame.....	30
Fixing the hanging frame to the wall.....	30
Connecting the device.....	31
Locking the device on the hanging frame.....	32
Operation	33
Use	
Turning on your device	34
Putting your device in standby mode	34
Choosing your heating mode	35
Heating your room: how to use Comfort mode	36
Lowering the temperature of your room: how to use Eco mode	37
Programming the heating period: how to use Programming mode.....	38 to 42
Absence of more than 24 hours: use the Frost Protection mode	43
How to use the energy-saving functions.....	44 to 48
Locking the controls.....	49
Locking the control panel	49
Calibrate the temperature	50
Maintenance	50
Returning to the standard factory settings	50
Troubleshooting	51
Warranty conditions.....	53

GB

The device you have just purchased was submitted to many tests and checks ensuring its quality. We thank you for your choice and trust. We hope you will be fully satisfied.

The references for your device

These are located on the right-hand side of the device.

The commercial code and the serial number identify for the manufacturer the particular device you have bought.

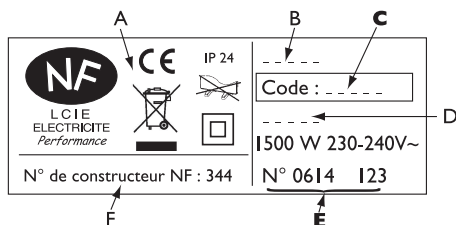

- A Standards, quality labels
- B Commercial name
- C **Commercial code**
- D Manufacturing reference
- E **Serial number**
- F Manufacturer's number



Devices with this symbol must not be scrapped with normal household rubbish but be collected separately and recycled.

When these products come to the end of their useful life, they must be collected and recycled in accordance with the local regulations and bylaws.

Please keep this instruction manual even after installing your device.

Warning

surface may be hot enough to cause burns to their skin in some circumstances, particularly because their reflexes may not yet have been acquired or are slower than those of an adult. If there is any risk, fit a protective grill in front of the device.

- This device is not intended for use by persons (*including children*) with physical, sensory or mental disability, or by persons lacking experience or knowledge, unless they have received from a person in charge of their safety adequate supervision or preliminary instructions on how to use the device.
- Care must be taken at all times to keep children from playing with the device.
-  - Do not obstruct the grills, even partially (*either on the front of the device or underneath it*); otherwise the device may overheat.
- If the supply cord is damaged, it must be replaced by a service agent or similarly qualified person in order to avoid a hazard (*applies to units fitted with a supply cord and plug*).
- Units fitted with a three core supply cord (*brown, blue and black*), must be directly connected to hard wiring by a licensed electrician.
- All work on the interior of the device must be carried out by a licensed electrician.

Installation

PREPARING THE INSTALLATION OF THE DEVICE

Installation guidelines

- This device was designed to be installed in residential premises. In any other case, please call your distributor.
- Installation must comply with the standards currently enforced in the country of use.
- The device must be supplied with 230V single-phase 50Hz.
- In damp areas such as bathrooms and kitchens, you must install the connection box at least 25cm above the floor.

GB

Keep the device away from any draughts that may interfere with its operation (e.g.: under a centrally controlled fan, etc...).

Do not install the heater under a fixed socket.

The device is fitted with a detection system, whose sensor is located on the front of the device.

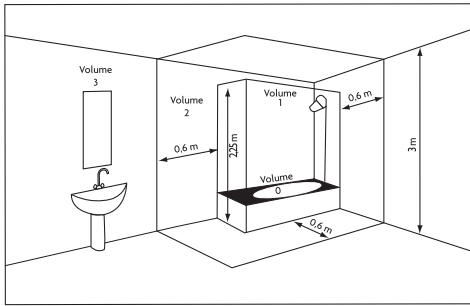

Volume 1	No electrical device
Volume 2	Class II IPX24 electrical device
Volume 3	Class II electrical device

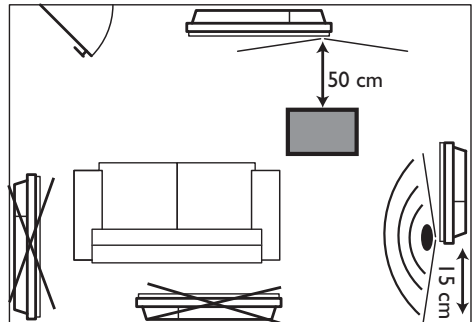
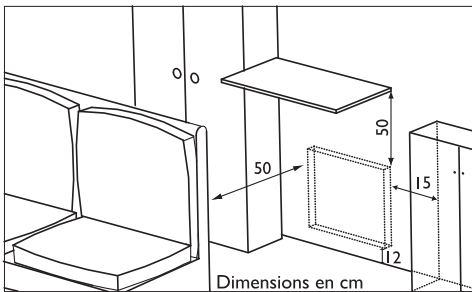

Comply with the minimum distances from any furniture units when positioning the device.

To optimise absence detection by your device, do not install it in a closed off corner or behind furniture.



We strongly advise against installing vertical machines above an altitude of 1000m (risk of faulty operation).

Installing a machine at altitude causes an increase in air output temperature (of the order of 10°C per 1000m above sea level).

It is forbidden to install a vertical machine horizontally or vice versa.

Do not use the device in mobile, on feets or on casters.

UNLOCKING THE DEVICE'S HANGING FRAME

We recommend that you place the device face down on the floor, taking care to protect its front surface from scratches.

1 Take a flat-bladed screwdriver and lift the slider, taking care not to bend it.

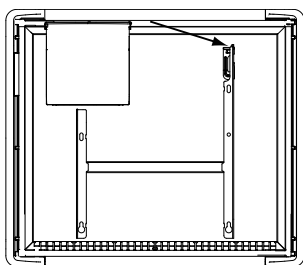

2 While keeping the slider raised, push the hanging frame towards the bottom of the heater to release the upper brackets **S2**. We recommend that you wear protective gloves.

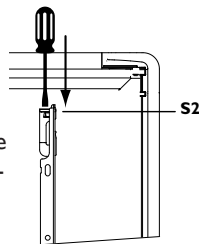

3 Swivel the hanging frame downwards on the lower brackets **S1**.

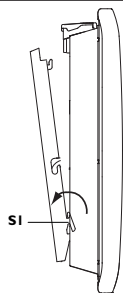

4 Remove the hanging frame.

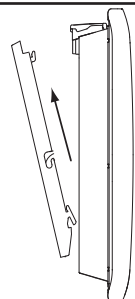

FIXING THE HANGING FRAME TO THE WALL

1 Place the hanging frame on the floor against the wall. Locate drilling points **A**.

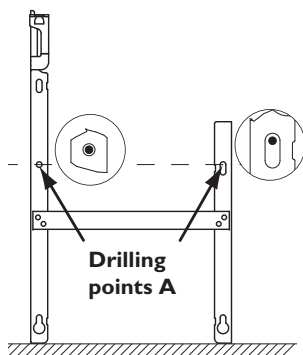

Drilling points A show the position for the lower fastenings.

2 Refit the hanging frame, lining up with drilling points **A** to find drilling points **B** (you can also use a level).

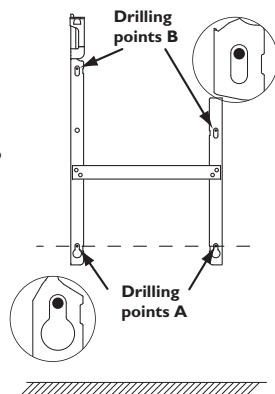

Drilling points B show the position for the upper fastenings.

3 Drill the 4 holes and insert the wall plugs. Use suitable wall plugs when fitting on a specific support (e.g. plasterboard wall).

4 Position the hanging frame and screw it down.

CONNECTING THE DEVICE

GB

Connection rules and regulations

- The device must be supplied with 230V single-phase current at 50Hz.
- The device's power supply must be directly connected to the main supply after the circuit breaker without any intermediate switch.
- The device's power cable must be connected to the main supply via a connection box. In damp areas, such as bathrooms and kitchens, the connection box must be installed at least 25cm above the floor.
- **An Earth connection is prohibited. Do not connect the pilot wire (black wire) to Earth.**
- The installation must be fitted with an all-pole cut-off switch with a contact opening distance of at least 3mm.
- If the power cable is damaged, it must only be replaced by an electrician.
- If you are using the pilot wire and it is protected by a 30mA differential (e.g.: *bathroom use*), the pilot wire's power supply must also be protected on this differential.

Wiring diagram for the heating panel

- Cut off the power supply and connect the wires as shown in the following diagram:

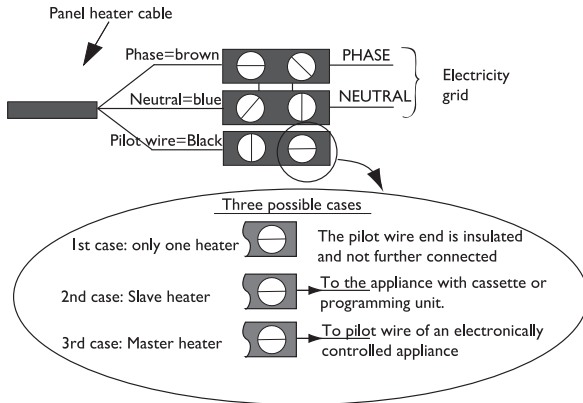

- You can connect the pilot wire if your home is equipped with a programming unit or controller. In this case, make the following checks according to the selected mode (*Comfort, Eco, etc.*) to that the programming instructions are being transmitted correctly:

	COMFORT	ECO	FROST	SWITCH-OFF OF HEATING AND POWER CUT-OFF	COMFORT -1°C	COMFORT -2°C
		ECO				
SIGNAL TO BE TRANSMITTED						
MEASUREMENT BETWEEN THE PILOT WIRE AND NEUTRAL	0 Volt	230 Volts	-115 Volts negative	+115 Volts positive	230 Volts for 3 s	230 volts for 7 s

LOCKING THE DEVICE ONTO THE HANGING FRAME

- 1
Position the tilted device on brackets **S1**.

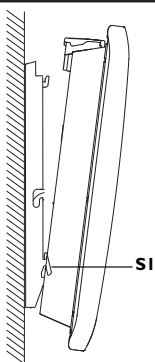

- 2
Pivot the device upwards and lift it to position it on brackets **S2**.

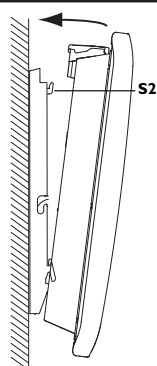

- 3
Lower the device onto the hanging frame. A click tells you that the device is fastened and locked in place.

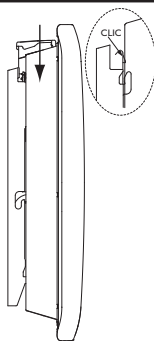

**Clip
& Go**

To unlock the device from the hanging frame, take a flat-bladed screwdriver and **push the slider** (located on the top left-hand corner of the hanging frame behind the device) **towards the wall**.

Lift the device while holding the slider in place with your screwdriver. Tilt it forwards and then remove it from brackets **S1**.

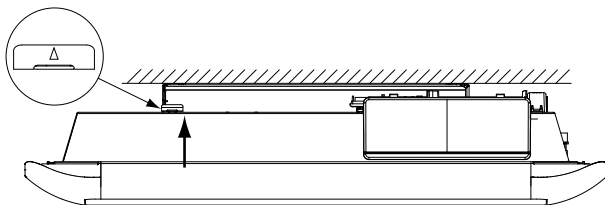

Operation

Control box

For your comfort and to save energy, your device is equipped with a digital-display control unit. You can set all of the device's functions from the unit.

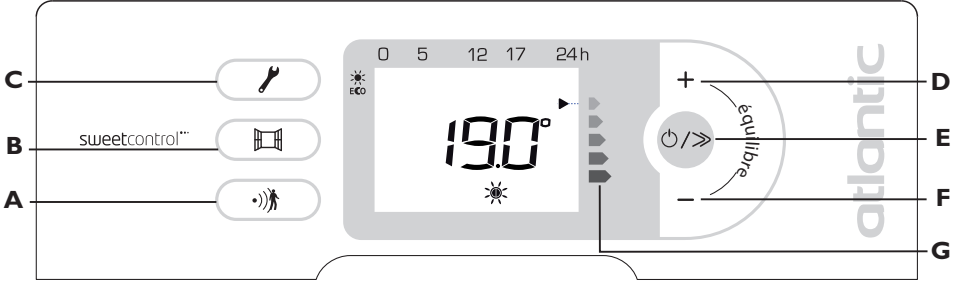

GB

- A** sweetcontrol™ absence and presence detector
- B** Airing function
- C** Programming / Set the correct time and day
- D** Increase the temperature / Scroll
- E** Turn on / Change heating modes – scroll / Standby
- F** Lower the temperature / Scroll
- G** Consumption indicator function

Remove the plastic film on the control unit

The different displays

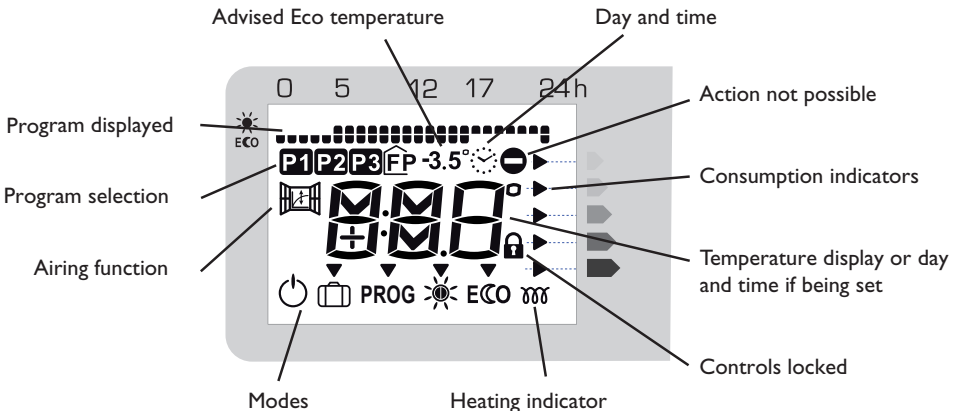

After 2 minutes of inactivity, the screen returns to the main display.

Use

TURNING ON YOUR DEVICE

To turn on your device, press the Power on key (E).

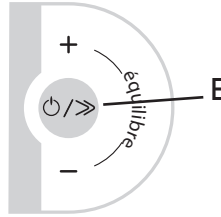

The device displays the 'comfort' temperature.

When first turned on, the device is set to Comfort mode at 19°C.

ACTIVATING THE SCREEN

If the screen is not lit up, press any button to activate the screen lighting.

If the screen backlighting is not active, press any button to reactive it.

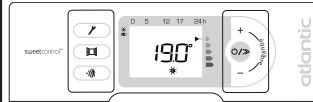

You can now press the appropriate button for the setting you want to make.

PUTTING YOUR DEVICE IN STANDBY MODE

To put your device in standby mode, hold the Standby key (E) down.

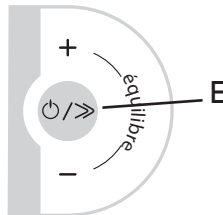

The panel displays **OFF** then turns off.

CHOOSING YOUR HEATING MODE

You can run your device in several modes:

- **Comfort mode** (☀️) which enables you to have the right ambient temperature.
- **Eco mode (ECO)** which enables you to lower the temperature in your room when you will be away from your home for a long time or during the night, especially in bedrooms.
- The Programming **PROG** mode, where you can program the Comfort and Eco modes depending on when the room is used, using programs P1, P2, P3 or using a (*centralised*) programming system.
- **Frost mode** (❄️) which enables you to maintain a temperature of around 7°C during an absence of more than 24 hours, for example.

GB



HEATING YOUR ROOM : HOW TO USE COMFORT MODE

DESCRIPTION

This mode enables you to have the ambient temperature you desire in your room. The consumption indicator lights enable you to optimise your setting (see page 48).

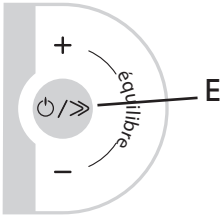

HOW TO ACTIVATE THIS MODE ?

If the screen is not lit up, press any button to activate the screen lighting.

<p>To activate the Comfort mode, press the Scroll key (E) several times until the arrow is on the Comfort  mode.</p>		<div style="text-align: center; border: 1px solid black; padding: 5px; margin-bottom: 10px;">  </div> <p>The mode selection arrow flashes for several seconds, then just the  icon remains on the display: the setting is confirmed.</p>
---	---	--

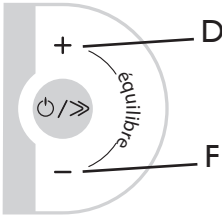

The advised Comfort temperature is 19°C.
The Comfort mode ranges from 12.5°C to 28°C.

HOW TO CHANGE THE TEMPERATURE

<p>To change the temperature displayed, press the + (D) or – (F) keys.</p>		<div style="text-align: center; border: 1px solid black; padding: 5px; margin-bottom: 10px;">  </div> <p>The heating icon  appears on the screen if the room temperature is lower than the one displayed.</p>
--	--	--

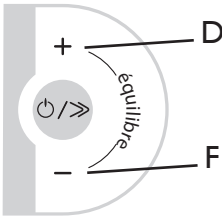

Wait at least 6 hours for the room's temperature to stabilise.

<p>If you want to change the room temperature, change it by pressing the + (D) or – (F) keys.</p>		<div style="text-align: center; border: 1px solid black; padding: 5px; margin-bottom: 10px;">  </div> <p>As the temperature displayed on the screen rises, the consumption indicator light descends.</p>
---	---	---

LOWERING THE TEMPERATURE IN YOUR ROOM : HOW TO USE ECO MODE

DESCRIPTION

We recommend that you use this mode when you will be absent for 2 to 24 hours, or during the night, especially in bedrooms.

Maximum Eco temperature is 19°C.

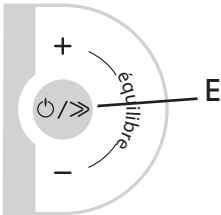
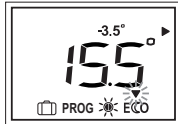

HOW TO ACTIVATE THIS MODE ?

<p>Press the scroll key (E) several times until the selection arrow is on ECO mode.</p>		 <p>The mode selection arrow flashes for several seconds, then just the ECO icon remains on the display: the setting is confirmed.</p>
---	---	---

The advised Eco temperature is -3.5°C compared with the Comfort temperature (setting example: 19°C in Comfort mode and 15.5°C in Eco mode). If the -3.5°C icon does not appear on the screen, this means that the difference compared with the set Comfort temperature is not 3.5°C .

If you lower the Comfort temperature to below the Eco temperature, the Eco temperature lowers by -0.5°C compared with the Comfort mode. If, however, you increase the Comfort temperature, the Eco temperature does not change.

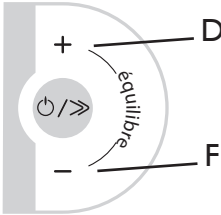
HOW TO CHANGE THE TEMPERATURE ?

<p>If you want, you can change the temperature displayed by pressing the + (D) or - (F) keys.</p>		 <p>The chosen Eco temperature appears on the screen.</p>
---	---	---

GB



PROGRAMMING THE HEATING PERIOD :

HOW TO USE PROG MODE PROG

You can program your Comfort  and ECO temperature times either by using one of the three prestored programs, or by connecting the pilot wire to a programming control (*Pilot wire (FP) mode is the default setting - refer to your programming control's manual*)

You can connect several devices to one programmer.

3 programs have been prestored: **P1**, **P2** and **P3** and they cannot be changed.

	0h	1h	2h	3h	4h	5h	6h	7h	8h	9h	10h	11h	12h	13h	14h	15h	16h	17h	18h	19h	20h	21h	22h	23h
P1  ECO																								
P2  ECO																								
P3  ECO																								

P1 is recommended for when you are constantly at home, at the weekend for example (Eco mode from 23h to 5h, Comfort mode from 5h to 23h).

P2 is recommended if you are absent during the day (Eco mode from 23h to 5h and from 9h to 17h, Comfort mode from 5h to 9h and from 17h to 23h).







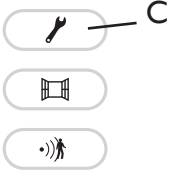

P3 is recommended if you are absent during the day, but you come back home at lunchtime (Eco mode from 23h to 5h, from 9h to 12h and from 14h to 17h, Comfort mode from 5h to 9h, from 12h to 14h and from 17h to 23h).

 means that a programming control is used.

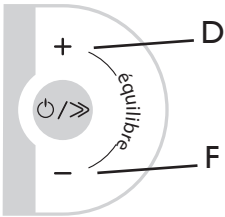
NB : *If no command is received on the pilot wire, the device will function in Comfort mode.
When switching from Comfort to Eco mode, the new mode is active after about 12 seconds.
The Frost Protection and Load shedding commands have priority over the Eco, Comfort and programming (P1, P2, P3 and ) modes.*

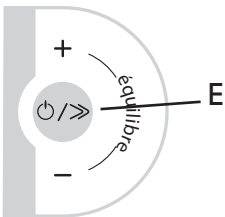
HOW TO SET THE DAY OF THE WEEK AND TIME ?

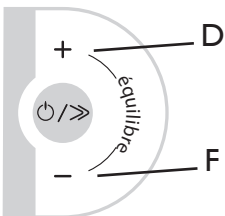
Before programming the device, you must set the device to the correct time or make sure that the system day and time is correct.

<p>To set the day of the week and the time, hold the Programming key (C) down for several seconds.</p>		 <p>The letters on the screen start flashing: you can now set the day of the week. (J= day - LU = Monday)</p>
<p>To change the day, press the + (D) or - (F) key.</p>		 <p>You have changed the day. You can now set the time.</p>
<p>To set the time, press the Scroll (E) key.</p>		 <p>The letters on the screen flash so that you can change the hour.</p>
<p>To change the hour, press the + (D) or - (F) key.</p>		 <p>You have changed the hour. You can now set the minutes.</p>

GB

To set the minutes, press the Scroll (E) key.

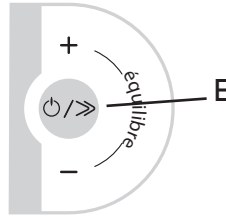

The letters on the screen flash so that you can change the minutes.

To change the minutes, press the + (D) or - (F) key.

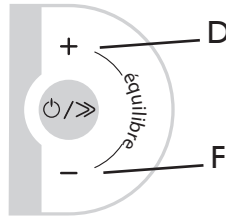

You can now confirm your setting.

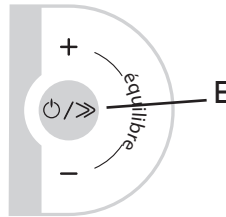

To confirm the minutes, press the Scroll (E) key.



The screen returns to the main menu.

N.B.: You can exit the settings at any time by pressing the Programming  key (C). The settings made are saved.

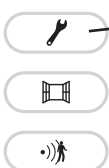

HOW TO ASSIGN A DAILY PROGRAM ?

<p>To access the daily program, press the Programming key (C).</p>	 <p>sweetcontrol™</p>	 <p>For Monday, the 'FP' program is selected. (J= day - LU = Monday - FP = programming control)</p>
--	--	--

GB

- Two solutions are possible :**
- a- you want to keep the selected program,**
 - b- you want to change the selected program.**

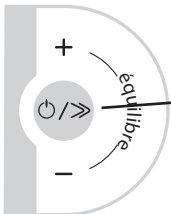
a- You want to keep the selected program – Monday in the example

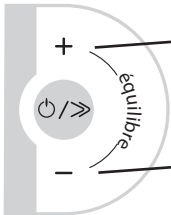
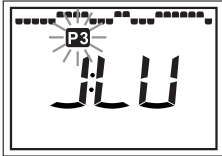

<p>You want to keep the 'FP' program for Monday: press the Scroll key (E).</p>		 <p>The program for Monday is confirmed. You can now select the program for Tuesday.</p>
--	---	---

b- You want to change the selected program – Monday in the example

<p>You want to change the 'FP' program for Monday: press the + (D) or - (F) key until the program you want flashes on the screen.</p>		 <p>You have chosen the P3 program for Monday, you can now confirm.</p>
---	---	--

HOW TO ASSIGN A DAILY PROGRAM TO ALL THE DAYS OF THE WEEK ?

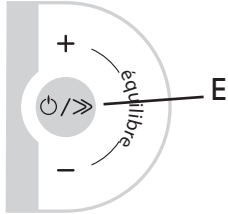
Carry out the same procedure for all the days of the week, up until Sunday, either keeping the selected program or changing it.

<p>Confirm the programs chosen for each day of the week by pressing the Scroll key (E).</p>		 <p>You have confirmed the daily programs. You must now activate the Programming PROG mode.</p>
---	---	--

N.B.: Even if there is a power cut, the settings are saved.

HOW TO ACTIVATE THE PROGRAMMING PROG MODE ?

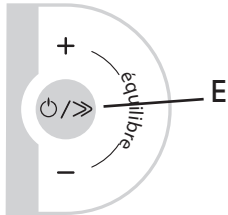
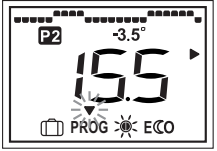
<p>To activate the Programming mode, press the Scroll key (E) until the arrow is on this mode PROG .</p>		 <p>The mode selection arrow flashes several seconds, then remains on the display with the icon PROG of the mode being programmed.</p>
--	--	---

N.B.: If the ☀ icon blinks, you need to check the day and time settings (see page 39).

ABSENCE OF MORE THAN 24 HOURS: USING THE FROST PROTECTION MODE

The Frost Protection  temperature is preset to 7°C ($\pm 3^\circ\text{C}$) and cannot be changed.

HOW TO ACTIVATE THE FROST PROTECTION MODE ?

Press the scroll key (E) until the selection arrow is on the Frost Protection  mode.

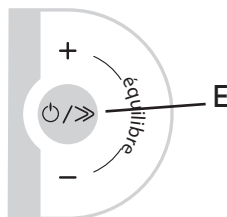

The mode selection arrow flashes for several seconds then the  icon remains on the display.

GB

HOW TO USE THE ENERGY-SAVING FUNCTIONS : ABSENCE AND PRESENCE DETECTION

These functions enable your device to adapt itself to your daily life without your having to concern yourself with it.

To use these functions, we recommend that you set the Comfort mode ☀ or Programming PROG mode.

These functions are in addition to the programming functions.

The function enables you to lower the temperature setting for your room automatically, as soon as you leave it.

Absence detection is made from a height of over 45cm (Diagram 1) and operates progressively (Diagram 2):

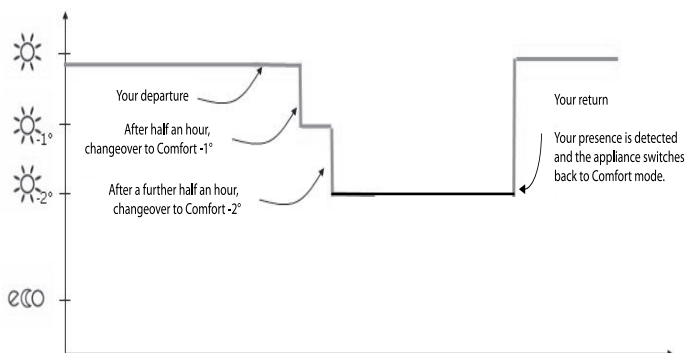
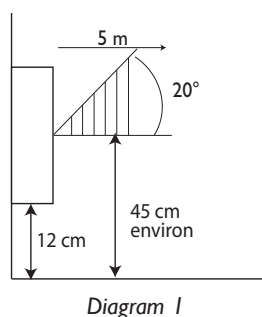

E.g.: Your device is set to 19°C, in Comfort mode (whether programmed or not)

At 9:00, it detects your absence.

At 9:30, its operating instructions are set to 18°C.

At 10:00, its operating instructions switch to 17°C.

HOW TO ACTIVATE THE ABSENCE AND PRESENCE DETECTION ?

To activate it, press the Sweetcontrol key (A).

sweetcontrol™

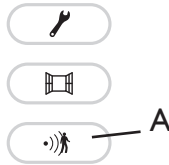

The .))人 symbol for absence / presence detection appears on the screen.

GB

If your device detects no one in the room, it automatically lowers the temperature setting progressively to 3.5°C lower than the Comfort temperature setting.

The .))人 symbol flashes when it detects a presence.

HOW TO DEACTIVATE THE ABSENCE AND PRESENCE DETECTION ?

To deactivate it, press the Sweetcontrol key (A).

sweetcontrol™

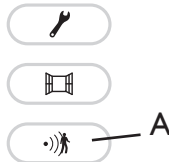

The .))人 symbol for absence / presence detection disappears from the screen.

HOW TO USE THE ENERGY-SAVING FUNCTIONS : AIRING FUNCTION

The function enables you to stop the device from heating and to start heating again automatically when you are airing your room, thereby saving you energy.

We do not recommend the use of the Airing  function in corridors and rooms located close to an entrance door from outside your home or from the garage.

Do not heat the room while it is being ventilated allow you to save energy. If you do not turn off your heater when a window is open for a long time, the airing function  stops your device from heating when it is not necessary: your heater automatically detects when the window is opened or closed and therefore saves energy.

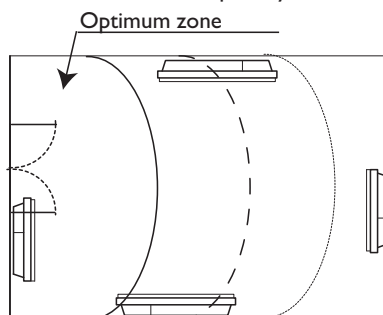

Your device reacts to an open or close window according to several variables, especially

- the temperature settings programmed for the room
- the outside temperature
- the location of your heater, etc.

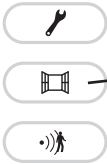

By detecting whether the window is open or closed, the airing function helps you to be environmentally friendly: you save energy by not heating your house when you ventilated it.

HOW TO ACTIVATE THE WINDOW OPEN AND CLOSED DETECTION ?

<p>To activate it, press the Aeration key (B).</p>	 <p>sweetcontrol™</p>	 <p>The  symbol for absence / presence detection appears on the screen.</p>
---	--	---

GB



The operating instructions are for $7^{\circ}\text{C} \pm 3^{\circ}\text{C}$ for the whole time that your room is being aired. When you close the window, your device will return to its initial operating mode.

After 2 hours, the device starts heating again in any case. The maximum expected airing period is 2 hours.

NNB: If the function does not meet your requirements, you can manually stop the device from heating (press the Power on key (E)  for several seconds).

The  symbol flashes when it is lowering its operating set point.

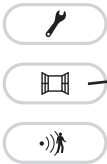

HOW TO DEACTIVATE THE WINDOW OPEN AND CLOSED DETECTION ?

<p>To deactivate it, press the Aeration key (B).</p>	 <p>sweetcontrol™</p>	 <p>The  symbol for window open and closed detection disappears from the screen.</p>
---	---	---

HOW TO USE THE ENERGY-SAVING FUNCTIONS : THE BALANCE FUNCTION

Use the Balance function to set your device at an optimum temperature that is just the right balance between being comfortable and saving energy.

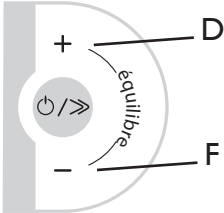
HOW TO USE THE BALANCE FUNCTION ?

<p>To use this function, press the Increase (D) and Decrease (F) keys simultaneously.</p>		 <p>The temperature displayed is 19°C in Comfort mode and 15.5°C in Eco mode.</p>
---	---	--

This function does not change how you have programmed your device.

HOW TO USE THE ENERGY-SAVING FUNCTIONS : CONSUMPTION INDICATOR

The energy consumed by an electrical heating device depends, among other things, on the temperature required. The temperature recommended by the public authorities is 19°C, in Comfort mode (15.5°C in Eco mode).

The “Consumption Indicator” function enables you to position yourself in accordance with this recommended temperature.

Therefore, depending on the temperature required:

- If the black arrow on the screen is placed before the 2nd orange or the red icon, you can save energy by significantly lowering the temperature you have asked for.
- If the black arrow on the screen is placed before the 1st orange icon, you can save energy by slightly lowering the temperature you have asked for.
- If the black arrow is in front of the green icon, you are already at the recommended temperature and are already making energy savings.

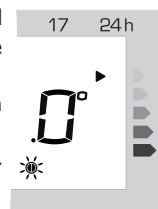



All the devices in the same room must be fitted with the same function capabilities. The energy-saving functions must be set in the same way on each heater.

LOCKING THE CONTROLS

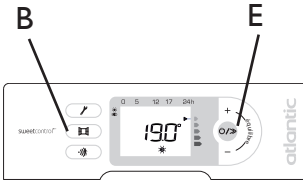

To avoid the control panel being used inopportunely, we advise you to lock it.

HOW TO LOCK THE CONTROLS ?

<p>To lock the controls, press the following keys simultaneously for several seconds:</p> <ul style="list-style-type: none"> - Aeration (B) and - Power on (E). 		 <p>A lock appears on the screen: the settings can no longer be changed.</p>
---	---	---

GB

HOW TO UNLOCK THE CONTROLS ?

<p>To unlock the controls, press the following keys simultaneously for several seconds:</p> <ul style="list-style-type: none"> - Aeration (B) and - Power on (E). 		 <p>The lock disappears from the screen: the settings can be changed.</p>
---	---	--

LOCKING THE CONTROL PANEL

You can also lock the control panel using the screw provided.

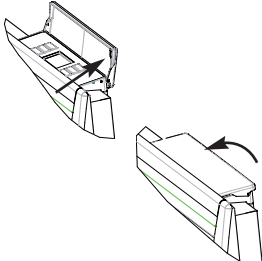
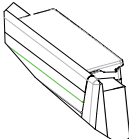
<p>Remove the screw located inside the control panel.</p> <p>Close the control panel's flap.</p> <p>Block the flap using the screw.</p>		 <p>The panel can no longer be opened, so the controls cannot be accessed.</p>
---	---	---

CALIBRATE THE TEMPERATURE

Depending on your installation, the temperature you read may be different to the one displayed on your device. In that case, you can calibrate the temperature displayed.

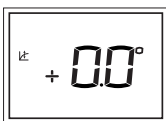
<p>Hold the following keys down simultaneously:</p> <ul style="list-style-type: none"> - Programming (C), - Power on (E). 		 <p>With the + (D) or - (F) keys, choose your calibration value (between -2°C and 2°C).</p>
---	---	--

E.g. The temperature displayed on your device is 20°C.

The temperature displayed on your thermometer is 19°C => Choose a calibration value of -1°C.

Confirm your choice by pressing the Programming key (C). Your device will heat until the room temperature reaches 20°C.



MAINTENANCE

To maintain your device's performance, you must dust it approximately twice a year.

Never use abrasive products or solvents.

RETURNING TO THE STANDARD FACTORY SETTINGS

It is possible to return to the standard settings for your device.

<p>Hold the following keys down simultaneously</p> <ul style="list-style-type: none"> - Aeration (B), - Settings (C), - Scroll (E), <p>until everything is displayed on the screen (see page 33 for the different displays).</p>		 <p>The device switches to Comfort mode at 19°C. The ECO mode is at 15.5°C. The energy saving and programmed functions are deactivated.</p>
---	---	--

TROUBLESHOOTING

PROBLEM ENCOUNTERED	CHECKS TO BE MADE
The heating light flashes	The temperature probe is disconnected or is faulty. Contact your installer.
The device does not heat.	Make sure that the  mode is activated. If you are operating under programming, check that the programmer is in COMFORT mode. Ensure that the installation's circuit breakers are engaged and that the power cut-off (if you have one) has not cut off the power to the device. Check the air temperature in the room: if it is too high, the heating light does not flash : the device does not heat.
The device heats all the time.	<ul style="list-style-type: none"> - Check that the device is not in a draught or that the temperature setting has not been altered. - There may be a fluctuation in the main power supply. If there is a problem (blocked thermostat...), cut off the power to the device (fuse, circuit breaker) for approximately 10 minutes and then switch it back on. - If the phenomenon recurs frequently, have your electricity utility check the power supply.
The device heats even though the window is open.	There may be a delay between when the window is opened and when the heating stops. If you find this delay too long, you can manually stop your device.
The device does not heat enough.	Increase the temperature settings by pressing the + (E) key. If the setting is at its maximum, carry out the following checks : <ul style="list-style-type: none"> - Check whether there is another heating device in the room. - Make sure that your device is only heating the room (door closed). - Check the supply voltage to the device. - Check that the power of your device is adapted to the size of your room (on average, we recommend 100 W/m² for a ceiling height of 2.50 m).
The heating light appears on the screen when the device is in Eco mode.	This is normal. The device can heat to maintain an Eco temperature.
Dirty marks appear on the wall around the device.	The dirty marks come from the bad quality of the air in the room. In this case, you are advised to check that the room is correctly aired (ventilation, vent duct, etc.), that the air is clean and not to smoke in the room. Your device will not be replaced under guarantee because of these dirty marks.

GB

PROBLEM ENCOUNTERED	CHECKS TO BE MADE
The device's surface is very hot.	It is normal for the device to be hot when it is operating; the maximum surface temperature is restricted in accordance with the NF electrical performance standard. However, if you think that your device is still too hot, check that the output is suitable for the area of your room (<i>we recommend 100W / m²</i>) and that the heater is not placed in a draught, which would interfere with its self-regulation; also check that the installation guidelines have been followed (<i>curtains, etc.</i>)
For devices equipped with a programming system or controlled via a pilot wire:	
The device is not responding to the external programming commands.	Make sure that the central programming system is working correctly (<i>refer to the user manual</i>), or that the programming control is correctly placed in its holder and that it is working correctly (<i>check the batteries, fuse, etc.</i>) Make sure that your device is in Programming mode and that the external "Centralised" program is assigned to the right day of the week.

If you do not succeed in solving your problem, contact your local installer and have the details of your device's references (see page 28), the room's temperature and the programming system (if any) to hand.

WARRANTY CONDITIONS

- The guarantee period is two years from the date of installation or purchase and may not exceed 30 months from the date of manufacture in the absence of a receipt.
- The guarantee covers the replacement and supply of components recognised as being defective, excluding any damages or interest.
- The user is responsible for any labour or transport costs.
- The guarantee does not cover any damage arising from improper installation, abnormal use or non-observance of the requirements of the said instructions for installation and use .
- The stipulations of the present guarantee conditions do not exclude any of the purchaser's legal rights of guarantee against faults or hidden defects, which are applicable in all cases under the stipulations of Articles 1641 of the Civil Code.
- Present this certificate to your distributor or installer only in the event of a claim, together with your purchase invoice.

TYPE OF DEVICE*:
SERIAL NUMBER*:
CUSTOMER'S NAME AND ADDRESS:
.....

* This information can be found on the information plate situated on the left-hand side of the device.

ATLANTIC INTERNATIONAL

Tel: (33) 146836000
Fax: (33) 146836001

FOR SALES IN NEW ZEAL

ANDATLANTIC AUSTRALASIA - Phone :
0800 422 000 - Fax : 04 3800 509

FOR SALES IN AUSTRALIA

ATLANTIC AUSTRALASIA PTY LTD
4/13-25 Church Street
Hawthorn Victoria 3122
Australia
Free call : 1800 677 857
Phone : 03 9852 9599
Fax : 03 9852 9844
web : www.atlantics.com.au



FOR SALES IN THE U.K.,

please contact :
ATOUR ATLANTIC LTD
Malling Works, Lewes
East Sussex BN7 2AY
Phone : 01580 2431 53
Fax : 01580 2411 80
E-mail : sales@tour-atlantic.ltd.uk

