

ENGLISH

# Canon DIGITAL IXUS WIRELESS



Before Using the Camera

Shooting

Playback/Erasing

Print/Transfer Settings

Viewing Images on a TV set

Customizing the Camera

Wireless Connection

Troubleshooting

List of Messages

Appendix

## Advanced

# Camera User Guide

This guide explains camera features and procedures in detail.

DiGi!C II



Exif Print



# Main Features

## Shooting

- Automatically adjusts shooting settings to match particular conditions (Scene mode)
- Automatically detects camera orientation with an Intelligent Orientation sensor
- Changes image colors to create special effects (My Colors modes)

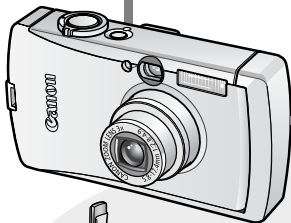

## Playback

- Plays movies with sound
- Auto plays slideshows

## Editing

- Records sound memos for still images
- Edits movies



## Printing via a wireless connection

- Prints images easily by attaching the supplied wireless print adapter to a Canon PictBridge compliant printer

## Transferring images to a computer\* via a wireless connection

- Transfers all images stored on a camera to the computer at the same time
- Shoots images and transfers them to a computer immediately

\* Connecting wirelessly between the camera and a computer is only possible with the Windows XP SP2 operating system.

# Conventions Used in this Guide

Icons appearing below titles indicate the modes in which the procedure can be used.

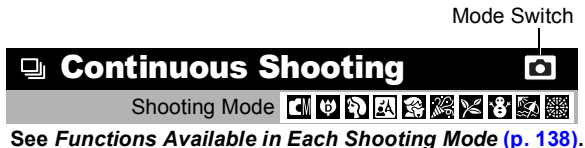

In this guide, the *Basic Camera User Guide* is referred to as the *Basic Guide*, and the *Advanced Camera User Guide* is referred to as the *Advanced Guide*.



This mark denotes issues that may affect the camera's operation.



This mark denotes additional topics that complement the basic operating procedures.

You can use SD\* memory cards and MultiMediaCards with this camera. These cards are collectively called memory cards in this guide.

\* SD stands for Secure Digital, a copyright protection system.

## Use of genuine Canon accessories is recommended.



This product is designed to achieve excellent performance when used with genuine Canon accessories. Canon shall not be liable for any damage to this product and/or accidents such as fire, etc., caused by the malfunction of non-genuine Canon accessories (e.g., a leakage and/or explosion of a battery pack). Please note that this warranty does not apply to repairs arising out of the malfunction of non-genuine Canon accessories, although you may request such repairs on a chargeable basis.

# Table of Contents

Items marked with a ☆ are lists or charts that summarize camera functions or procedures.

Conventions Used in this Guide . . . . .	1
Handling Precautions . . . . .	5
Please Read . . . . .	5
Operation Restrictions . . . . .	6
Safety Precautions . . . . .	9
Preventing Malfunctions . . . . .	14
Before Using the Camera—The Components Guide . . . . .	15
Before Using the Camera—Basic Operations . . . . .	19
Using the LCD Monitor . . . . .	19
LCD Monitor Brightness . . . . .	21
Information Displayed on the LCD Monitor . . . . .	22
Using the Viewfinder . . . . .	25
Indicators . . . . .	26
Power Saving Function . . . . .	27
Formatting Memory Cards . . . . .	28
Setting the World Clock . . . . .	29
Menus and Settings . . . . .	31
Menu List . . . . .	33
Resetting Settings to Their Default Values . . . . .	37
Shooting . . . . .	38
Changing the Recording Pixels and Compression (Still Images) . . . . .	38
Changing Recording Pixels and Frame Rates (Movies) . . . . .	40
Magnified Close-Up Shooting (Digital Macro) . . . . .	41
Using the Digital Zoom . . . . .	42
📄 Continuous Shooting . . . . .	43
Postcard Date Imprint Mode . . . . .	44
🕒 Using the Self-Timer . . . . .	45
🎬 Movie Shooting . . . . .	47
Shooting Panoramic Images (Stitch Assist) . . . . .	49
Switching between Focusing Modes . . . . .	51



Shooting Hard-to-Focus Subjects (Focus Lock, AF Lock) . . .	52
Locking the Exposure Setting (AE Lock) . . . . .	53
Locking the Flash Exposure Setting (FE Lock) . . . . .	54
Switching between Metering Modes . . . . .	55
Adjusting the Exposure Compensation . . . . .	56
Shooting in Long Shutter Mode . . . . .	57
Adjusting the Tone (White Balance) . . . . .	59
Changing the Photo Effect . . . . .	62
Shooting in a My Colors Mode . . . . .	63
<b>ISO</b> Adjusting the ISO Speed . . . . .	69
Setting the Auto Rotate Function . . . . .	70
Creating an Image Destination (Folder) . . . . .	71
Resetting the File Number . . . . .	72
<b>Playback/Erasing . . . . .</b>	<b>74</b>
 Magnifying Images . . . . .	74
 Viewing Images in Sets of Nine (Index Playback) . . . . .	75
 Jumping to Images . . . . .	76
Viewing Movies . . . . .	77
Editing Movies . . . . .	78
Rotating Images in the Display . . . . .	80
Playback with Transition Effects . . . . .	81
Attaching Sound Memos to Images . . . . .	81
Automated Playback (Slide Shows) . . . . .	83
Protecting Images . . . . .	87
Erasing All Images . . . . .	87
<b>Print Settings/Transfer Settings . . . . .</b>	<b>88</b>
Setting the DPOF Print Settings . . . . .	88
Setting the DPOF Transfer Settings . . . . .	91
<b>Viewing Images on a TV set . . . . .</b>	<b>93</b>
<b>Customizing the Camera (My Camera Settings) . . . . .</b>	<b>94</b>
Changing My Camera Settings . . . . .	94
Registering My Camera Settings . . . . .	95

Using Wireless Connection (Connecting to Printer) . . . . .	97
Connecting to a Printer. . . . .	98
Deleting target devices. . . . .	104
Troubleshooting . . . . .	105
Camera. . . . .	105
When the power is turned on . . . . .	105
LCD monitor. . . . .	106
Shooting. . . . .	107
Shooting Movies. . . . .	111
Playback. . . . .	112
Battery/Battery Charger . . . . .	113
TV monitor output. . . . .	113
Wireless connection to a printer. . . . .	114
List of Messages. . . . .	115
Appendix. . . . .	119
Battery Handling. . . . .	119
Handling the Memory Card . . . . .	121
Using an AC Adapter Kit (Sold Separately) . . . . .	123
Using an Externally Mounted Flash (Sold Separately) . . . . .	124
Camera Care and Maintenance . . . . .	126
Specifications . . . . .	127
INDEX. . . . .	135
☆ Functions Available in Each Shooting Mode . . . . .	138

# Handling Precautions

## Please Read

### Test Shots

Before you try to photograph important subjects, we highly recommend that you shoot several trial images to confirm that the camera is operating and being operated correctly.

Please note that Canon Inc., its subsidiaries and affiliates, and its distributors are not liable for any consequential damages arising from any malfunction of a camera or accessory, including memory cards, that results in the failure of an image to be recorded or to be recorded in a way that is machine readable.

### Warning Against Copyright Infringement

Please note that Canon digital cameras are intended for personal use and should never be used in a manner that infringes upon or contravenes international or domestic copyright laws and regulations. Please be advised that in certain cases the copying of images from performances, exhibitions, or commercial properties by means of a camera or other device may contravene copyright or other legal rights even if the image was shot for personal use.

### Warranty Limitations

For information on your camera's warranty, please refer to the Canon European Warranty System (EWS) Booklet supplied with your camera.

**For Canon Customer Support contacts, please see rear of this booklet or the European Warranty System (EWS) Booklet.**

### Camera Body Temperature

If your camera is used for prolonged periods, the camera body may become warm. Please be aware of this and take care when operating the camera for an extended period.

### About the LCD Monitor

The LCD monitor is produced with extremely high-precision manufacturing techniques. More than 99.99% of the pixels operate to specification. Less than 0.01% of the pixels may occasionally misfire or appear as red or black dots. This has no effect on the recorded image and does not constitute a malfunction.

## Video Format

Please set the camera's video signal format to the one used in your region before using it with a TV monitor (p. 93).

## Language Setting

Please see the *Basic Guide* (p. 4) to change the language setting.

# Operation Restrictions

- The wireless function used in this equipment has been approved for domestic use. For use of this function in other countries, please inquire through Canon's Customer Service Center.
- France: Using the wireless function outdoors is prohibited.
- Italy: If used outside of own premises, general authorization is required.
- Latvia: If used outside of own premises, general authorization is required.
- This device may experience signal interference caused by other devices emitting radio waves (microwave ovens, Bluetooth appliances, cordless telephones, etc.). Keep the device away from such devices or do not use the devices at the same time.



## Restrictions for EU/EFTA Countries to R&TTE Directive:

BE	NL	LU	<del>FR</del>	<del>IT</del>	DE	GB	IE
DK	GR	ES	PT	AT	FI	SE	PL
HU	CZ	SK	SI	EE	<del>LV</del>	LT	CY
MT	IS	NO	CH	LI			

Note: - Member states in EU with restrictive use for this product are crossed out.

France: Can not be used outdoors.

Italy: If used outside of own premises, general authorization is required.

Latvia: If used outside of own premises, general authorization is required.

### Statement on EC directive

Contains already Notified Transmitter Module :CM13264

Hereby, Canon Inc., declares that this CM13264 is in compliance with the essential requirements and other relevant provisions of Directive 1999/5/EC.

Canon Inc. vakuuttaa täten että CM13264 tyyppinen laite on direktiivin 1999/5/EY oleellisten vaatimusten ja sitä koskevien direktiivin muiden ehtojen mukainen.

Hierbij verklaart Canon Inc. dat het toestel CM13264 in overeenstemming is met de essentiële eisen en de andere relevante bepalingen van richtlijn 1999/5/EG  
Bij deze verklaart Canon Inc. dat deze CM13264 voldoet aan de essentiële eisen en aan de overige relevante bepalingen van Richtlijn 1999/5/EC.

Par la présente Canon Inc. déclare que CM13264 est conforme aux exigences essentielles et aux autres dispositions pertinentes de la directive 1999/5/CE

Par la présente, Canon Inc. déclare que ce CM13264 est conforme aux exigences essentielles et aux autres dispositions de la directive 1999/5/CE qui lui sont applicables

Härmed intygar Canon Inc. att denna CM13264 står i överensstämmelse med de väsentliga egenskapskrav och övriga relevanta bestämmelser som framgår av direktiv 1999/5/EG.

Undertegnede Canon Inc. erklærer herved, at følgende udstyr CM13264 overholder de væsentlige krav og øvrige relevante krav i direktiv 1999/5/EF

Hiermit erklärt Canon Inc., dass sich dieser/diese/dieses CM13264 in Übereinstimmung mit den grundlegenden Anforderungen und den anderen relevanten Vorschriften der Richtlinie 1999/5/EG befindet". (BMW)

Hiermit erklärt Canon Inc. die Übereinstimmung des Gerätes CM13264 mit den grundlegenden Anforderungen und den anderen relevanten Festlegungen der Richtlinie 1999/5/EG. (Wien)

ΜΕ ΤΗΝ ΠΑΡΟΥΣΑ Canon Inc. ΔΗΛΩΝΕΙ ΟΤΙ CM13264 ΣΥΜΜΟΡΦΩΝΕΤΑΙ ΠΡΟΣ ΤΙΣ ΟΥΣΙΩΔΕΙΣ ΑΠΑΙΤΗΣΕΙΣ ΚΑΙ ΤΙΣ ΛΟΙΠΕΣ ΣΧΕΤΙΚΕΣ ΔΙΑΤΑΞΕΙΣ ΤΗΣ ΟΔΗΓΙΑΣ 1999/5/EK

Con la presente Canon Inc. dichiara che questo CM13264 è conforme ai requisiti essenziali ed alle altre disposizioni pertinenti stabilite dalla direttiva 1999/5/CE.

Por medio de la presente Canon Inc. declara que el CM13264 cumple con los requisitos esenciales y cualesquiera otras disposiciones aplicables o exigibles de la Directiva 1999/5/CE

Canon Inc. declara que este CM13264 está conforme com os requisitos essenciais e outras disposições da Directiva 1999/5/CE.

Společnost Canon Inc. tímto prohlašuje, že CM13264 splňuje základní požadavky a další příslušné ustanovení Direktivy 1999/5/EC.

Sellega kinnitab Canon Inc., et see CM13264 vastab direktiivi 1999/5/EC põhilistele nõudmistele ja muudele asjakohastele määrustele.

Ar šo, Canon Inc., apstiprina, ka CM13264 atbilst Direktīvas 1999/5/EK galvenajām prasībām un citiem tās nosacījumiem.

Šiuo, Canon Inc., pareiškia, kad šis CM13264 atitinka pagrindinius Direktyvos 1999/5/EB reikalavimus ir kitas svarbias nuostatas.

Alulírott, Canon Inc., kijelenti, hogy a jelen CM13264 megfelel az 1999/5/EC irányelvben meghatározott alapvető követelményeknek és egyéb vonatkozó előírásoknak.
Hawnhekk, Canon Inc., tiddikjara li CM13264 josserva l-ħtiġijiet essenzjali u dispożizzjonijiet relevanti oħra tad-Direttiva 1995/5/KE.
Canon Inc. niniejszym oświadcza, że CM13264 spełnia zasadnicze wymogi oraz inne istotne postanowienia dyrektywy 1999/5/EC.
S tem Canon Inc. izjavlja, da je ta CM13264 v skladu z osnovnimi zahtevami in ostalimi ustreznimi predpisi Direktive 1999/5/EC.
Spoločnosť Canon Inc. týmto vyhlasuje, že CM13264 spĺňa základné požiadavky a ďalšie príslušné ustanovenia Direktívy 1999/5/EC.
С настоящия документ Canon Inc. декларира, че CM13264 е в съгласие с основните изисквания и съответните постановления на Директива 1999/5/EC.
Prin prezenta, Canon Inc. declară că acest CM13264 este conform cu cerințele principale și cu celelalte prevederi relevante ale Directivei 1999/5/EC.
İşbu belge ile Canon Inc., bu CM13264'in 1995/5/EC Yönetmeliği esas gereksinimlerine ve diğer şartlarına uygun olduğunu beyan eder.
MADE IN JAPAN

 N118

## Safety Precautions

- Before using the camera, please ensure that you read the safety precautions described below and in the “Safety Precautions” section of the *Basic Guide*. Always ensure that the camera is operated correctly.
- The safety precautions noted on the following pages are intended to instruct you in the safe and correct operation of the camera and its accessories to prevent injuries or damage to yourself, other persons and equipment. Be sure you fully understand them before reading the rest of the manual.

- Equipment refers to the camera, battery charger, wireless print adapter or separately sold compact power adapter.
- Battery refers to the battery pack.

## **⚠ Warnings**

### **Equipment**

- **Do not aim the camera directly into the sun or at other intense light sources that could damage your eyesight.**
- **Store this equipment out of the reach of children and infants.**
  - Wrist strap: Placement of the strap around the child's neck could result in asphyxiation.
  - Memory card: Dangerous if accidentally swallowed. If this occurs, contact a doctor immediately.
- **Do not attempt to disassemble or alter any part of the equipment that is not expressly described in this guide.**
- **To avoid the risk of high-voltage electrical shock, do not touch the flash portion of the camera if it has been damaged.**
- **Stop operating the equipment immediately if it emits smoke or noxious fumes.**
- **Do not allow the equipment to come into contact with, or become immersed in, water or other liquids. If the exterior comes into contact with liquids or salt air, wipe it dry with a soft, absorbent cloth.**

Continued use of the equipment may result in fire or electrical shock. Immediately turn the camera power off and remove the camera battery or unplug the power cord from the power outlet. Please consult your camera distributor or the closest Canon Customer Support Help Desk.

- **Do not use substances containing alcohol, benzene, thinners or other flammable substances to clean or maintain the equipment.**
- **Do not cut, damage, alter or place heavy items on the power cord.**
- **Use only recommended power accessories.**
- **Remove the power cord on a regular periodic basis and wipe away the dust and dirt that collects on the plug, the exterior of the power outlet and the surrounding area.**
- **Do not handle the power cord if your hands are wet.**

Continued use of the equipment may result in fire or electrical shock.

## **Battery**

- **Do not place the battery near a heat source or expose it to direct flame or heat.**
- **The battery should not be immersed in water or sea water.**
- **Do not attempt to disassemble, alter or apply heat to the battery.**
- **Avoid dropping or subjecting the battery to severe impacts that could damage the casing.**
- **Use only recommended battery and accessories.**

Use of battery not expressly recommended for this equipment may cause explosions or leaks, resulting in fire, injury and damage to the surroundings. In the event that a battery leaks and the eyes, mouth, skin or clothing contact these substances, immediately flush with water and seek medical assistance.

- **Disconnect the battery charger and compact power adapter from the camera or the wireless print adapter and the power outlet after recharging or when they are not in use to avoid fire and other hazards.**
- **Do not place anything, such as tablecloths, carpets, bedding or cushions, on top of the battery charger while it is charging.**

Continued use over a long period may cause the units to overheat and distort, resulting in fire.

- **Use only the specified battery charger to charge the battery.**
- **The battery charger and compact power adapter are designed for exclusive use with your camera. Do not use it with other products or batteries.**

There is a risk of overheating and distortion which could result in fire or electrical shock.

- **Before you discard a battery, cover the terminals with tape or other insulators to prevent direct contact with other objects.**

Contact with the metallic components of other materials in waste containers may lead to fire or explosions.

### Others

- **Do not trigger the flash in close proximity to human or animal eyes. Exposure to the intense light produced by the flash may damage eyesight.**

In particular, remain at least one meter (39 inches) away from infants when using the flash.

- **Keep objects that are sensitive to magnetic fields (such as credit cards) away from the speaker of the camera.**

Such items may lose data or stop working.

- **If you wish to use a wireless connection inside an aircraft or hospital, always follow the instructions of the airline or hospital staff.**

The camera emits electromagnetic waves which may affect instruments, medical devices and other sensitive equipment.

## **Cautions**

### Equipment

- **Be careful not to bang the camera or subject it to strong impacts or shocks that could lead to injury or damage the equipment when wearing or holding it by the strap.**

- **Do not store the equipment in humid or dusty areas.**
- **Do not allow metal objects (such as pins or keys) or dirt to contact the charger terminals or plug.**

Such conditions could lead to fire, electrical shock or other damage.

- **Avoid using, placing or storing the equipment in places subject to strong sunlight or high temperatures, such as the dashboard or trunk (boot) of a car.**
- **Ensure that the battery charger or the compact power adapter are plugged into a power outlet of the specified rating, not over the specified rating. Do not use if the power cord or plug are damaged, or if not fully plugged into the outlet.**
- **Do not use in locations with poor ventilation.**

The above-mentioned can cause leakage, overheating or explosion, resulting in fire, burns or other injuries. High temperatures may also cause deformation of the casing.

- **When not using the camera for extended periods of time, remove the battery from the camera or battery charger and store the equipment in a safe place.**

The battery can run down.

- **If the AC adapter kit or battery charger is connected to, for example, an electronic transformer for travel abroad, trouble with the camera may result, so please do not use such a device.**

## Flash

- **Do not operate the flash with dirt, dust or other items stuck to the surface of the flash.**
- **Be careful not to cover the flash with your fingers or clothing when shooting.**

The flash may be damaged and emit smoke or noise. The resulting heat build-up could damage the flash.

- **Do not touch the surface of the flash after taking several pictures in rapid succession.**

Doing so could result in burns.

# Preventing Malfunctions

## Avoid Strong Magnetic Fields

- **Never place the camera in close proximity to electric motors or other equipment generating strong electromagnetic fields.**

Exposure to strong magnetic fields may cause malfunctions or corrupt image data.

## Avoid Condensation Related Problems

- **When moving the equipment rapidly between hot and cold temperatures, you can avoid condensation by placing the equipment in an airtight, resealable plastic bag and letting it adjust to temperature changes slowly before removing it from the bag.**

Moving the equipment rapidly between hot and cold temperatures may cause condensation (water droplets) to form on its external and internal surfaces.

## If Condensation Forms Inside the Camera

- **Stop using the camera immediately.**

Continued use may damage the equipment. Remove the memory card and battery or compact power adapter from the camera and wait until the moisture evaporates completely before resuming use.

## Front View

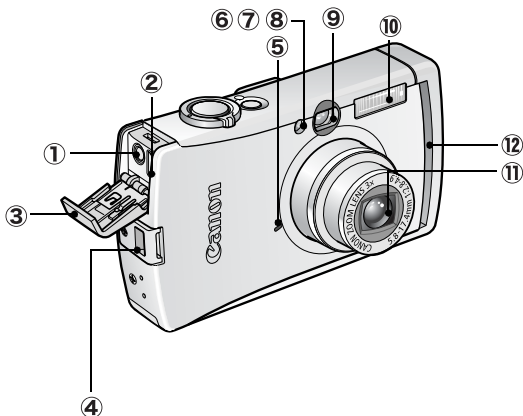

- ① AV OUT (Audio/Video output) Terminal (p. 93)
- ② DIGITAL Terminal
- ③ Terminal Cover
- ④ Wrist Strap Mount
- ⑤ Microphone (p. 81)
- ⑥ AF-assist Beam (p. 33)
- ⑦ Red-Eye Reduction Lamp (*Basic Guide* p. 9)
- ⑧ Self-Timer Lamp (p. 45)
- ⑨ Viewfinder Window (p. 25)
- ⑩ Flash (*Basic Guide* p. 9)
- ⑪ Lens
- ⑫ Wireless Lamp (p. 26)



The interface cable and AV cable cannot be connected simultaneously.

### How to Attach the Wrist Strap\*

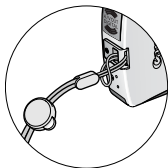

### How to Open the Terminal Cover



\* When carrying the camera by the strap, be careful not to swing the camera or catch it on other items.

## Back View

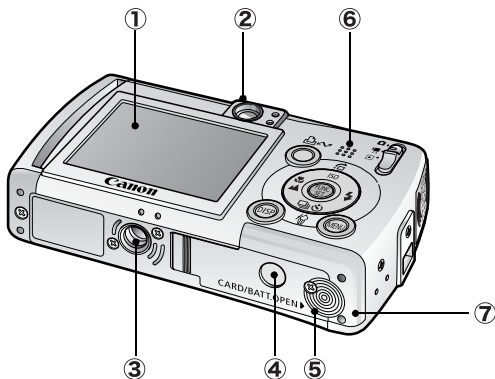

- ① LCD Monitor (p. 19)
- ② Viewfinder (p. 25)
- ③ Tripod Socket
- ④ DC Coupler Terminal Cover (p. 123)
- ⑤ Memory Card Slot/Battery Cover (*Basic Guide* p. 2)
- ⑥ Speaker
- ⑦ Battery Compartment (Memory Card/Battery Compartment)

# Operation Panel

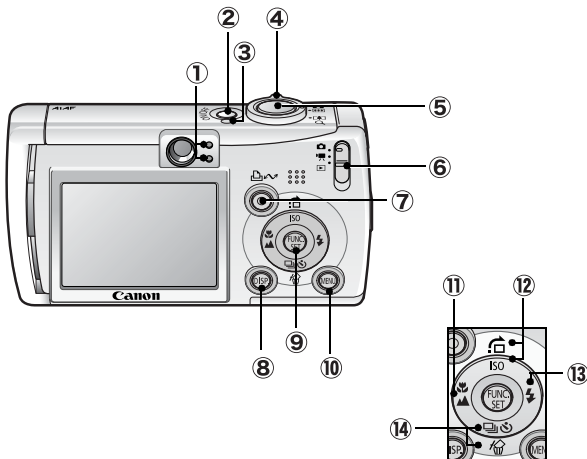

- ① Indicators (p. 26)
- ② Power Button (*Basic Guide* p. 5)
- ③ Power Lamp
- ④ Zoom Lever (p. 74, *Basic Guide* p.8)  
Shooting: (Wide Angle)/ (Telephoto)  
Playback: (Index)/ (Magnify)
- ⑤ Shutter Button (*Basic Guide* p. 5)
- ⑥ Mode Switch (*Basic Guide* pp. 5, 6)
- ⑦ (Print/Share) Button (*Basic Guide* p. 14)
- ⑧ **DISP.** (Display) Button (p. 19)
- ⑨ **FUNC./SET** (Function/Set) Button (p. 31)
- ⑩ **MENU** Button (p. 32)
- ⑪ (Macro)/ (Infinity)/ Button (*Basic Guide* p. 10)
- ⑫ ISO (ISO Speed)/ (Jump)/ Button (pp. 69, 76)
- ⑬ (Flash)/ Button (*Basic Guide* p. 9)
- ⑭ (Single Image Erase)/ (Continuous)/ (Self-timer)/ Button (pp. 43, 45, *Basic Guide* p. 11)

# Wireless Print Adapter

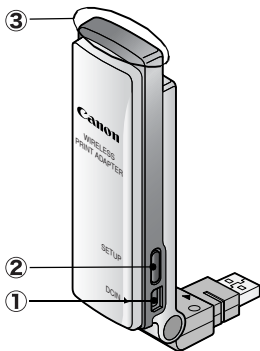

- ① DC IN (power) Terminal (p. 99)
- ② **SETUP** button (p. 103)
- ③ Wireless Lamp (p. 26)

## Using the LCD Monitor



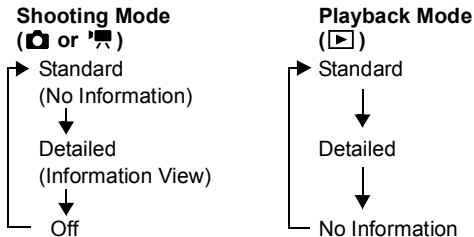

### 1 Press .

- The display mode changes as follows with each press.



- In the shooting modes, the shooting information displays for approximately 6 sec. when a setting is changed, regardless of the selected display mode.



- The LCD monitor on or off setting is retained even after the camera power is turned off.
- The LCD monitor does not shut off in the , ,  or  mode.
- The LCD monitor will not switch to the detailed display in the index playback mode (p. 75).

## Using the Clock

You can display the current date and time for a 5-second\* interval using the following two methods.

\* Default setting



### Method 1

Hold the **FUNC./SET** button down while turning on the power.

### Method 2

In a shooting mode, hold the **FUNC./SET** button down.

If you hold the camera horizontally, it displays the time. If you hold it vertically, the time and date display.

However, if you hold the camera vertically and use method 1 to display the date and time, the time will be initially displayed in the same way as when the camera is held horizontally.

- You can change the display color by pressing the ◀ or ▶ button.
- The clock display will cease when the display interval is over or when you operate the **FUNC./SET**, **MENU** or shutter button or the mode switch.
- The clock's display interval can be changed in the  (Set up) menu (p. 35).

# LCD Monitor Brightness

## LCD Monitor Brightness Settings

The brightness of the LCD monitor can be changed in the following two ways.

- Changing Settings Using the Set up Menu (p. 35)
- Changing Settings Using the **DISP.** Button (Quick-bright LCD Function)

You can set the LCD monitor to the brightest setting regardless of the option selected in the Set up menu by pressing the **DISP.** button for more than one second\*.

- To restore the previous brightness setting, press the **DISP.** button for more than one second again.
- The next time you turn on the camera, the LCD monitor will be at the brightness setting selected in the Set up menu.

\* You cannot change the brightness of the LCD monitor with this function if you have already set it to its highest setting in the Set up menu.

## Night Display

When shooting in dark conditions, the camera automatically brightens the LCD monitor to suit the brightness of the subject\*, making it easier to frame the subject.

\* Noise will appear, and the movements of the subject will appear irregular on the LCD monitor. The recorded image will not be affected. The brightness of the image displayed in the monitor, and the brightness of the actual image recorded will be different.

# Information Displayed on the LCD Monitor

## Shooting Information (Shooting mode)

[ ] \* Spot Frame

□ \* AF Frame (p. 51)

🔋 \* Low Battery (p. 119)

3.0x Zoom Magnification\* (p. 42)

Grid Lines\* (p. 33)

Wireless Connection (p. 101)

- Stills: Recordable Shots
- Movies (Sec.): Remaining Elapsed Time

ISO 50 ISO 100 ISO 200 ISO 400  
ISO Speed (p. 69)

📷 📄 🔄 🔄 🔄  
Shooting Method (pp. 43, 45)

📷 📷  
Macro/Infinity (*Basic Guide* p. 10)

⚡ 🔦 🔦 🔦 🔦 🔦 🔦  
Flash (*Basic Guide* p. 9)

📷 📷 📷  
Auto Rotate (p. 70)

● (Red)\*  
Movie Recording (p. 47)

🔒 \* AE Lock (p. 53)

🔒 \* FE Lock (p. 54)

🔒 \* AF Lock (p. 52)

🌐 \* Time Zone (p. 29)

📁 \* Create Folder (p. 71)

📷 📷 📷 Metering Mode (p. 55)

📷 📷  
Compression (p. 39)

📷 📷 📷  
Frame Rate (Movie) (p. 40)



L M1 M2 S 📷 📷 📷  
Recording Pixels (pp. 38, 40)

📷 (Red)\* Camera Shake Warning (p. 106)  
(The shutter speed will also display when the 📷 displays.)

📷 📷 📷  
Exposure Shift Bar (Movie) (p. 49)

📷 📷 📷 📷 📷 📷 📷 📷  
My Colors (p. 63)



If the indicator blinks orange and the camera shake icon  displays, it indicates there is insufficient illumination and a slow shutter speed will be selected. Raise the ISO speed (p. 69) or select a setting other than  (flash off), or attach the camera to a tripod or other device.

## Playback Information (Playback Mode)

### Standard

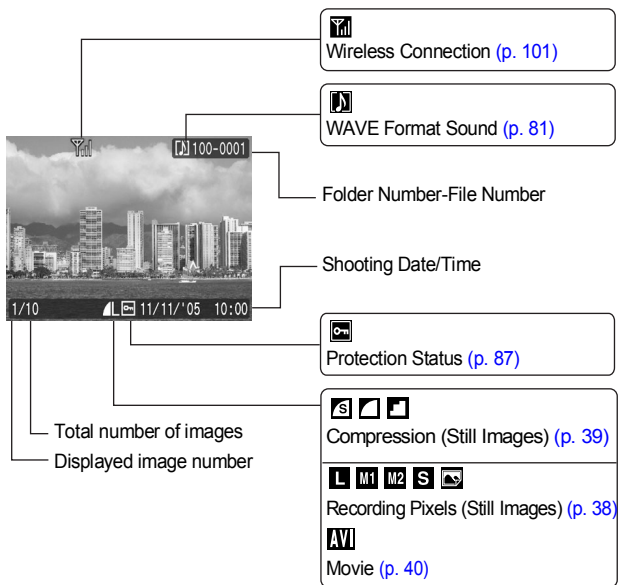

## Detailed

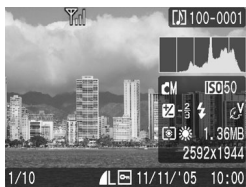

Histogram



Shooting Mode (pp. 41, 47, 49, 63, *Basic Guide* pp. 7, 8)

1" ... 15"\*

Long Shutter Mode (p. 57)

ISO 50 ISO100 ISO200 ISO400

ISO Speed (p. 69)

160 320 160 160 160 160

Recording Pixels (Movies) (p. 40)

Frame Rate (Movies) (p. 40)

	Exposure Compensation (p. 56)
	Flash ( <i>Basic Guide</i> p. 9)
	Macro/Infinity ( <i>Basic Guide</i> p. 10)
	Photo Effect (p. 62)
	My Colors (p. 63)
	Metering Mode (p. 55)
	White Balance (p. 59)
	File Size
	Transfer to computer complete
	Recording Pixels (Still Images) (p. 38)
	Movie Length (Movies) (p. 47)

The following information may also be displayed with some images.

	A sound file in a format other than the WAVE format is attached or the file format is not recognized.
	JPEG image not conforming to Design rule for Camera File System Standards
	RAW image
	Unrecognized data type



Information for images shot on other cameras may not display correctly.

## Histogram Function

The histogram is a graph that allows you to judge the brightness of the shot image. The greater the bias toward the left in the graph, the darker the image. The greater the bias toward the right, the brighter the image.

If the image is too dark, adjust the exposure compensation to a positive value. Similarly, adjust the exposure compensation to a negative value if the image is too bright (p. 56).

Sample Histograms



Dark Image



Balanced Image



Bright Image

## Using the Viewfinder

The viewfinder can be used to conserve power by turning the LCD monitor off (p. 19) while shooting.

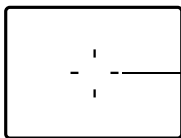

Viewfinder

Shows the center of the image

# Indicators

The indicators of the camera and the wireless print adapter light or blink in the following situations.



Never do the following while an indicator is blinking. These actions may corrupt image data.

- Shake or jolt the camera
- Shut off the power, or open the memory card slot/battery cover

## Camera

### ●Upper Indicator

- Green: Ready to shoot  
Blinking Green: Image recording/reading/erasing/transferring (when connected to a computer)  
Orange: Ready to shoot (flash on)  
Blinking Orange: Ready to shoot (camera shake warning)

### ●Lower Indicator

- Yellow: Macro mode/infinity mode/AF lock mode  
Blinking Yellow: Focusing difficulty (camera beeps once)

### ●Wireless Lamp

- Blue: Standing by for printing or transfer\*  
Blinking Blue (slowly): Wireless connection active/Currently registering target device  
Blinking Blue (rapidly): Data transfer underway

\* When the wireless connection is extremely weak, the wireless lamp blinks, as does the  icon on the LCD monitor. (p. 95).

## Wireless Print Adapter

- Blue: Wireless connection active  
Blinking Blue (slowly): Wireless connection on standby  
Blinking Blue (rapidly): Data transfer underway  
Blinking Blue and Orange: Currently registering target device  
Orange: Registration failed.  
Blinking Orange: Error\*

\* An irregularity occurred in the wireless print adapter. Disconnect the wireless print adapter from the printer, then reconnect it. When using the compact power adapter, pull out the power cord, disconnect the wireless print adapter from the printer, reconnect it, then reinsert the power cord. If the lamp blinks orange frequently, bring the camera to a Canon Customer Support Help Desk.

# Power Saving Function

This camera is equipped with a power saving function. The power will shut off in the following circumstances. Press the power button again to restore power.

<b>Shooting Mode</b>	Powers down approximately 3 minutes after the last control is accessed on the camera. The LCD monitor automatically turns off 1 minute* <sup>1</sup> after the last control is accessed even if [Auto Power Down] is set to [Off]. Press any button other than the power button or change the camera orientation to turn the LCD monitor back on.
<b>Playback Mode Connected to a Printer*<sup>2</sup></b>	Powers down approximately 5 minutes after the last control is accessed on the camera.

\*<sup>1</sup>This time can be changed.

\*<sup>2</sup>When connecting to a printer using the interface cable provided.



- Under the conditions below, the power saving function cannot be used.
  - During automatic slideshow playback
  - During wireless connection (Playback Mode)
  - When connecting to a computer using the interface cable provided
- The power saving function settings can be changed (p. 35).

# Formatting Memory Cards

You should always format a new memory card or one from which you wish to erase all images and other data.



Please note that formatting (initializing) a memory card erases all data, including protected images and other file types.

1

## **[F]** (Set up) Menu ► [Format].

See *Menus and Settings* (p. 32).

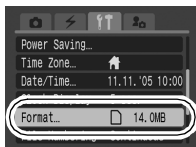

2

## Select [OK] and press .

- To perform a low level format, use the **▲** button to select [Low Level Format] and the **◀** or **▶** button to add a check mark.
- You can stop formatting a card when [Low Level Format] is selected by pressing the **FUNC./SET** button. You can still use a card without problem when formatting is halted, but its data will be erased.

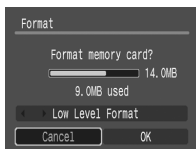

## Low Level Format

We recommend you select [Low Level Format] when you think that the recording/reading speed of a memory card has dropped. A low level format may require 2 to 3 minutes with some memory cards.

# Setting the World Clock

When traveling abroad, you can record images with local dates and times simply by switching the time zone setting if you pre-register the destination time zones. You can enjoy the convenience of not having to switch the Date/Time settings.

## Setting the Home/World Time Zones

- 1  (Set up) Menu ▶ [Time Zone] ▶  .

See Menus and Settings (p. 32).



- 2  ▶  .



- 3 Use the ← or → button to select a home time zone ▶  .

- To set the daylight saving option, use the ↑ or ↓ button to display  . The time will advance by 1 hour.



- 4  ▶  .



## 5 Use the ← or → button to select a destination time zone ▶ .

- As in Step 3, you can set the daylight saving option.

Time Difference from the Home Time Zone



## 6 Use the ↑ or ↓ button to select [Home/World], and the ← or → button to select ▶ .

### Switching to the Destination Time Zone

## 1 (Set up) Menu ▶ [Time Zone] ▶ .

See *Menus and Settings* (p. 32).



## 2 Use the ← or → button to select ▶ .

- To change the destination time zone, use the **FUNC./SET** button.

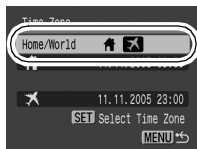

If you change the date and time when the World option is selected, the Home date and time will also change automatically.

# Menus and Settings

Menus are used to set the shooting and playback settings as well as such camera settings as the date/time, electronic beep and wireless connection. The following menus are available.

## ●FUNC. Menu

## ●Rec., Play, Wireless, Set up and My Camera Menus

### FUNC. Menu

This menu sets many of the common shooting functions.

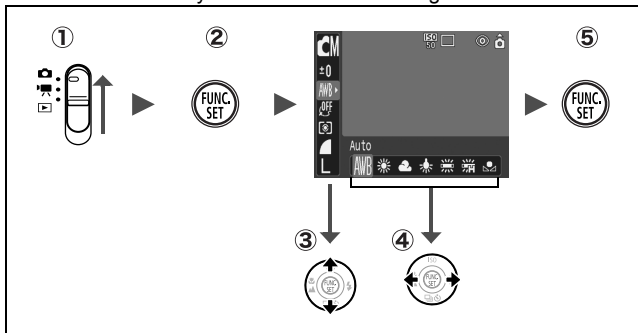

- ① Slide the mode switch to or .
- ② Press the FUNC./SET button.
- ③ Use the or button to select a menu item.  
Some items may not be selectable in some shooting modes.
- ④ Use the or button to select an option for the menu item.

You can select further options with the **MENU** button for some options.

After selecting an option, you can press the shutter button to shoot immediately. After shooting, this menu will appear again, allowing you to adjust the settings easily.

- ⑤ Press the FUNC./SET button.

## Rec., Play, Wireless, Set up and My Camera Menus

Convenient settings for shooting or playback can be set with these menus.

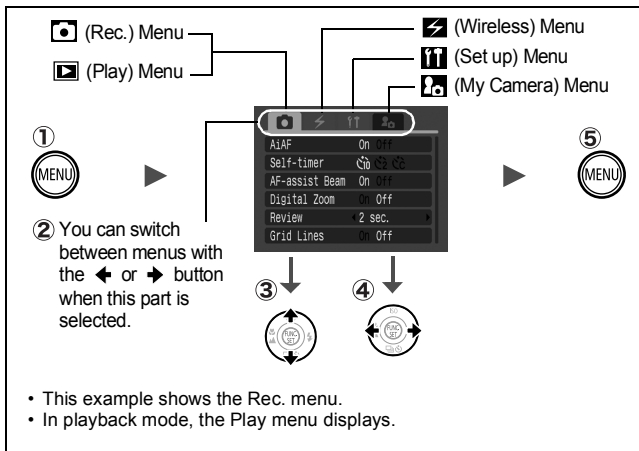

### ① Press the MENU button.

### ② Use the ◀ or ▶ button to switch between menus.

You can also use the zoom lever to switch between menus.

### ③ Use the ▲ or ▼ button to select menu items.

Some items may not be selectable in some shooting modes.

### ④ Use the ◀ or ▶ button to select an option.













- Menu items followed by an ellipsis (...) can only be set after pressing the **FUNC./SET** button to display the next menu. Press the **FUNC./SET** button again to confirm the setting.
- When selecting items from the ⚡ (Wireless) menu, the method of operation depends on the menu item. Please confirm precise instructions on the appropriate operational procedure page.

### ⑤ Press the MENU button.

# Menu List



## FUNC. Menu



The icons shown below are the default settings.

Menu Item	Page	Menu Item	Page
 Shooting Mode	<i>Basic</i> p. 5	 My Colors	p. 63
 Movie Mode	p. 47	 Metering Mode	p. 55
 Exposure Compensation	p. 56	 Compression	p. 39
 Long Shutter Mode	p. 57	 Frame Rate (Movie)	p. 40
 White Balance	p. 59	 Recording Pixels (Still Image)	p. 38
 Photo Effect	p. 62	 Recording Pixels (Movie)	p. 40









## Rec. Menu

\* Default setting

Menu Item	Options	Page/Topic
AiAF	On*/Off	p. 51
Self-timer	 10 seconds*/  2 seconds/  Custom Timer (Delay: 0–10*, 15, 20, 30 sec.) (Shots: 1–3*–10)	p. 45
AF-assist Beam	On*/Off	–
Digital Zoom	On/Off* (On in standard movie mode.)	p. 42
Review	Off/2*–10 seconds/Hold	<i>Basic Guide</i> p. 6
Save Original	On/Off*	p. 65
Grid Lines	On/Off*	You can display grid lines (splits screen into nine areas) to make it easier to judge the horizontal and vertical alignment of a photographic subject and to make composition easier. The lines will not be recorded in the images.
Date Stamp	Off*/Date/Date & Time	p. 44
Long Shutter	On/Off*	p. 57

Stitch Assist	 Left to right*/  Right to left	p. 49
---------------	---	-------

## Play Menu

	Menu Item	Page
	Protect	p. 87
	Rotate	p. 80
	Sound Memo	p. 81
	Erase All	p. 87
	Slide Show	p. 83
	Print Order	p. 88
	Transfer Order	p. 91
	Transition	p. 81

## Wireless Menu

\* Default setting

Menu Item	Options	Page/Topic
Connect/Disconnect		p. 100, <i>Software &amp; Wireless Guide</i>
Reg. Target Device		p. 102, <i>Software &amp; Wireless Guide</i>
Delete Registration		p. 104, <i>Software &amp; Wireless Guide</i>
Auto Transfer	On*/Off	<i>Software &amp; Wireless Guide</i>

## Set up Menu

\* Default setting

Menu Item	Options	Page/Topic
Mute	On/Off*	Set to [On] to silence the start-up, operation, self-timer and shutter sounds all at once. However, warnings still sound even when the mute is set to [On]. ( <i>Basic Guide</i> p. 5)

Volume	Off/1/2*/3/4/5	Adjusts the volume of the start-up sound, operation sound, self-timer sound, shutter sound and playback sound. The volume cannot be adjusted if [Mute] is set to [On].
Start-up Vol.		Adjusts the volume of the start-up sound when the camera is turned on.
Operation Vol.		Adjusts the volume of the operation sound that plays when any button other than the shutter button is pressed.
Selftimer Vol.		Adjusts the volume of the self-timer sound played 2 sec. before the shutter is released.
Shutter Volume		Adjusts the volume of the sound played when the shutter releases. The shutter sound does not play when a movie is recording.
Playback Vol.		Adjusts the volume of movie sounds and sound memos.
LCD Brightness	-7-0*-+7	Use the ◀ or ▶ button to adjust the brightness. If you press the ▲ or ▼ button, the display returns to the Set up menu. You can check the brightness on the LCD monitor while you are adjusting the setting.
Power Saving		<a href="#">p. 27</a>
Auto Power Down	On*/Off	Sets whether or not the camera automatically powers down after a set period of time elapses without the camera being operated.
Display Off	10 sec./20 sec./ 30 sec./1 min.*/ 2 min./3min.	Sets the length of time before the LCD monitor turns off when no camera operation is performed.
Time Zone	Home*/World	<a href="#">p. 29</a>
Date/Time		<i>Basic Guide</i> p. 4
Clock Display	0-5*-10 sec./20 sec./30 sec./1 min./2 min./3 min.	<a href="#">p. 20</a>

Format		<a href="#">p. 28</a>
File Numbering	Auto Reset/ Continuous*	<a href="#">p. 72</a>
Create Folder		<a href="#">p. 71</a>
Create New Folder	Check mark (On)/ No check mark (Off)	Creates a folder for the next shooting session.
Auto Create	Off*/Daily/ Monday–Sunday/ Monthly	You can also set a creation time.
Auto Rotate	On*/Off	<a href="#">p. 70</a>
Language		<i>Basic Guide</i> p. 4
Video System	NTSC/PAL	<a href="#">p. 93</a>
Reset All		<a href="#">p. 37</a>

## My Camera Menu

\* Default setting

Menu Item	Available Settings	Page
Theme	Selects a common theme for each My Camera settings item.	<a href="#">p. 94</a>
Start-up Image	Sets the image displayed when the camera power is turned on.	
Start-up Sound	Sets the sound played when the camera power is turned on.	
Operation Sound	Sets the sound played when any button other than the shutter button is pressed.	
Selftimer Sound	Sets the sound played 2 seconds before the shutter releases in self-timer mode.	
Shutter Sound	Sets the sound played when the shutter button is pressed. There is no shutter sound for movies.	
My Camera Menu Contents	(Off) /  */  /	

# Resetting Settings to Their Default Values

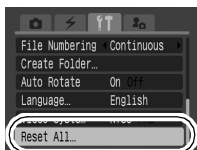

## 1 (Set up) Menu ► [Reset All].

See *Menus and Settings* (p. 32).



## 2 Select [OK] and press .



- Settings cannot be reset when the camera is connected to a computer or to a printer.
- The following cannot be reset.
  - Shooting mode
  - Item chosen from the  (Wireless) menu
  - The [Time Zone], [Date/Time], [Language] and [Video System] options in the  (Set up) menu (pp. 35, 36)
  - White balance data recorded with the custom white balance function (p. 60)
  - Colors specified in the [Color Accent] (p. 66) or [Color Swap] (p. 67) modes of My Colors.
  - Newly added My Camera settings (p. 95)

## Changing the Recording Pixels and Compression (Still Images)



Shooting Mode



### 1 FUNC. Menu **L**\* (Recording Pixels)/\* (Compression).

See *Menus and Settings* (p. 31).

\* Default setting.

- Use the  or  button to select recording pixels/compression settings and press the **FUNC./SET** button.





### Approximate Values for Recording Pixels

Recording Pixels		Purpose	
<b>L</b> (Large)	2592 × 1944 pixels	High ↑	Print larger than A4-size prints* 210 × 297 mm (8.3 × 11.7 in.) Print larger than Letter-size prints* 216 × 279 mm (8.5 × 11 in.)
<b>M1</b> (Medium 1)	2048 × 1536 pixels		Print up to A4-size prints* 210 × 297 mm (8.3 × 11.7 in.) Print up to Letter-size prints* 216 × 279 mm (8.5 × 11 in.)
<b>M2</b> (Medium 2)	1600 × 1200 pixels	↓ Low	Print postcard-size prints 148 × 100 mm (6 × 4 in.) Print L-size prints 119 × 89 mm (4.7 × 3.5 in.)
<b>S</b> (Small)	640 × 480 pixels		Send images as e-mail attachments Shoot more images
 (Postcard Date Imprint Mode)	1600 × 1200 pixels	When printing to postcards (p. 44).	

\* Paper sizes vary according to region.

## Approximate Values for Compression Settings



Compression		Purpose
 <b>Superfine</b>	High Quality	Shoot higher quality images
 <b>Fine</b>	↕	Shoot normal quality images
 <b>Normal</b>	Normal	Shoot more images



- See *Image Data Sizes (Estimated)* (p. 132).
- See *Memory Cards and Estimated Capacities* (p. 131).

# Changing Recording Pixels and Frame Rates (Movies)

Shooting Mode  

You can change the recording pixels and frame rate when the movie mode is set to  (Standard) or  (My Colors).

## 1 FUNC. Menu \* (Recording Pixels)/ \* (Frame Rate).







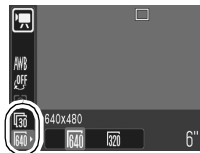



See *Menus and Settings* (p. 31).

\*Default setting.



- Use the  or  button to select a recording pixels/frame rate and press the **FUNC./SET** button.



## Recording Pixels and Frame Rates

	Recording Pixels	Frame Rate (frames/sec.)		
		 60	 30	 15
 Standard	 640 640 × 480 pixels	–	<input type="radio"/>	<input type="radio"/>
 My Colors	 320 320 × 240 pixels	–	<input type="radio"/>	<input type="radio"/>
 Fast Frame Rate	 320 320 × 240 pixels	<input type="radio"/>	–	–
 Compact	 160 160 × 120 pixels	–	–	<input type="radio"/>

\* Frame rates indicate the number of frames recorded or played back each second. The higher the frame rate, the smoother the appearance of motion.

\* The recording pixels and frame rate are fixed in the  and  modes.



- See *Image Data Sizes (Estimated)* (p. 132).
- See *Memory Cards and Estimated Capacities* (p. 131).

# Magnified Close-Up Shooting (Digital Macro)

Shooting Mode 

You can shoot a subject 3 – 10 cm (1.2 – 3.9 in.) from the end of the lens at the maximum wide angle setting. With the digital zoom, the image area is 9 × 7 mm (0.36 × 0.27 in.) at maximum zoom (approximately 4 times).

## 1 **FUNC. Menu** \* **(Auto)** **(Digital Macro).**

See *Menus and Settings* (p. 31).

\*Default setting.



## 2 **Choose the angle of view with the zoom lever and shoot.**

# Using the Digital Zoom



Shooting Mode



You can shoot zoomed images using the combined digital and optical zooms.

- Stills: zoom up to approximately 12 times
- Movies (Standard): zoom up to approximately 12 times



The digital zoom cannot be used when the LCD monitor is turned off.

## 1 (Rec.) Menu ► [Digital Zoom] ► [On].

See *Menus and Settings* (p. 32).

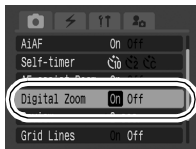

## 2 Press the zoom lever toward and shoot.

- The combined digital and optical zoom setting will display on the LCD monitor.
- When you press the zoom lever toward , the zoom stops when the lens reaches the maximum optical telephoto setting (when shooting still images). Press the zoom lever toward again to activate the digital zoom and further zoom the image digitally.
- Press the zoom lever toward to zoom out.



Images become coarser the more they are digitally zoomed.



# Postcard Date Imprint Mode



Shooting Mode



You can shoot images with the optimal settings for postcards by composing them inside the print area (width-to-height ratio of approximately 3:2) shown on the LCD monitor.

## 1 FUNC. Menu ► **L**\* (Recording Pixels) ►

### (Post Card Date Imprint).

See *Menus and Settings* (p. 31).

\*Default setting.

- The recording pixels are set to **M2** (1600 × 1200) and the compression to (Fine).
- When you press the shutter button halfway, the area that will not get printed grays out.



The digital zoom cannot be used in this mode.



For printing instructions, refer to the *Direct Print User Guide*.

## Embedding the Date in the Image Data

You can embed the date in image data when (Postcard Date Imprint Mode) is selected.

### 1 (Rec.) Menu ► [Date Stamp] ► [Date]/[Date & Time].

See *Menus and Settings* (p. 32).

#### ● LCD Monitor Display

: [Off]

: [Date]/[Date & Time]







- Ensure that the camera's date/time is set beforehand (p. 35).
- The date stamp cannot be deleted from the image data once it has been set.

## Using the Self-Timer



Shooting Mode





You can set a 10 sec. () or 2 sec. () delay, or a custom delay time and the number of shots () Custom Timer), for shooting after the shutter button is pressed.

**1 Press the  button to display ,  or .**

**2 Shoot.**

- When the shutter button is pressed fully, the self-timer will activate and the self-timer lamp will blink. When using red-eye reduction, the self-timer lamp will blink and then stay lit for the last 2 seconds.

### To Cancel the Self-Timer

Press the  button to display .





You can change the self-timer sound (p. 36).

## Changing the Self-Timer Countdown Time (/)

**1  (Rec.) Menu ► [Self-timer] ►  or .**

See *Menus and Settings* (p. 32).

- The following occurs with each option.
  - : 2 seconds before the shutter releases, the self-timer sound and lamp will speed up.
  - : The self-timer sound will play when the shutter button is pressed and the shutter will release 2 seconds later.



## Changing the Delay Time and Number of Shots (📷).

You can change the delay time (0–10, 15, 20, 30 sec.) and number of shots (1–10). These settings, however, cannot be set for the Stitch Assist mode, movie mode or My Colors modes.

### 1 📷 (Rec.) Menu ▶ [Self-timer] ▶ 📷 ▶ FUNC SET.

See *Menus and Settings* (p. 32).



### 2 Change [Delay]/[Shots] ▶ FUNC SET.

- The self-timer sound will behave as follows.
  - The self-timer sound will start 2 seconds before the specified delay for shooting is over.
  - If multiple shots have been specified for the [Shots] option, the sound will play for the first shot only.

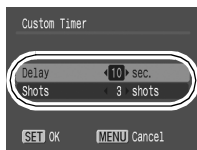

If the [Shots] option is set to 2 or more shots, the following occurs.

- The exposure and white balance are locked at the settings selected for the first shot.
- If the flash is used, the interval between shots lengthens because the flash must charge.
- The interval between shots lengthens when the built-in memory of the camera fills.
- Shooting will automatically cease if the memory card becomes full.



The following four movie modes are available.





	<b>Standard</b> <p>You can select the recording pixels and frame rate and record until the memory card is full (when a super high-speed memory card is used, such as the recommended SDC-512MSH). The digital zoom can be used while shooting in this mode (p. 42).</p> <ul style="list-style-type: none"><li>• Recording Pixels:  (640 × 480),  (320 × 240)</li><li>• Frame Rate:  (30 frames/sec.),  (15 frames/sec.)</li><li>• Maximum Size: 1 GB/movie</li></ul>
	<b>Fast Frame Rate</b> <p>Use this mode to record fast moving subjects, such as in sports photography.</p> <ul style="list-style-type: none"><li>• Recording Pixels:  (320 × 240)</li><li>• Frame Rate:  (60 frames/sec.)</li><li>• Maximum Clip Length: 1 minute</li></ul>
	<b>Compact</b> <p>Since the recording pixels are low, this mode is convenient for sending movies as e-mail attachments or when the memory card capacity is low.</p> <ul style="list-style-type: none"><li>• Recording Pixels:  (160 × 120)</li><li>• Frame Rate:  (15 frames/sec.)</li><li>• Maximum Clip Length: 3 minutes</li></ul>
	<b>My Colors</b> <p>You can change image colors and then shoot (p. 63). As with the Standard mode, you can also select the recording pixels and frame rate and record until the memory card is full (when a super high-speed memory card is used, such as the recommended SDC-512MSH).</p> <ul style="list-style-type: none"><li>• Recording Pixels:  (640 × 480),  (320 × 240)</li><li>• Frame Rate:  (30 frames/sec.),  (15 frames/sec.)</li><li>• Maximum Size: 1 GB/movie</li></ul>

- The maximum recording time will vary according to the capacity of the memory card you use (p. 131).

## 1 FUNC. Menu \* (Standard).

See *Menus and Settings* (p. 31).

\*Default setting.

- Use the  or  button to select a movie mode and press the **FUNC./SET** button.
- In  or  mode, you can change the recording pixels and frame rate (p. 40).

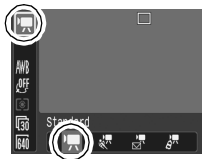

## 2 Shoot.

- Pressing the shutter button halfway automatically sets the exposure, focus and white balance settings.
- Pressing the shutter button fully starts recording video and sound simultaneously.
- During shooting the recording time (in seconds) and [●Rec] appear on the LCD monitor.
- Pressing the shutter button fully again stops recording. Recording will stop automatically under the following circumstances.
  - When the maximum recording time elapses
  - When the built-in memory or memory card become full



- You are recommended to use a memory card that has been formatted in your camera to shoot movies (p. 28). The card supplied with the camera may be used without further formatting.
- Be careful of the following while recording.
  - Try not to touch the microphone.
  - Do not press any buttons other than the shutter button. The sound that buttons make will be recorded in the movie.
  - The camera will automatically adjust the exposure and white balance to suit the shooting conditions during recording. Please note, however, that the sounds made by the camera automatically adjusting the exposure may also be recorded.
- The focus and optical zoom settings remain fixed for subsequent frames at the values selected for the first frame.
- With a wireless connection, movies cannot be shot.



- Before recording, you can set the AE lock (p. 53) and exposure shift.
  1. Press the **ISO** button.  
The exposure will lock (AE lock) and the exposure shift bar will appear on the LCD monitor.
  2. Use the **←** or **→** button to adjust the exposure.  
Press the **ISO** button again to release the setting. Also, the setting will be canceled if you press the **MENU** button or change the white balance, photo effect or shooting mode settings.
- QuickTime 3.0 or later is required to play back movies (Data type: AVI/Compression method: Motion JPEG) on a computer. QuickTime (for Windows) is included on the Canon Digital Camera Solution Disk. On the Macintosh platform, this program is standard with Mac OS X or later.

## Shooting Panoramic Images (Stitch Assist)

Shooting Mode 

Stitch Assist can be used to shoot overlapping images that can later be merged (stitched) to create one panoramic image on a computer.



The overlapping seams of several adjacent images can be joined into a single panoramic image.



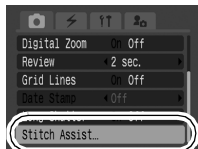

### 1 (Rec.) Menu **[Stitch Assist]**.

See *Menus and Settings* (p. 32).



## 2 Select a shooting direction

- You can select from the following two shooting directions.
  -  Left to right horizontally
  -  Right to left horizontally

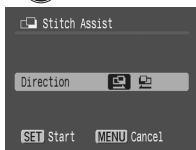

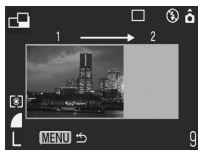

## 3 Shoot the first image in the sequence.

- The exposure and white balance are set and locked with the first image.



## 4 Compose the second image so that it overlaps a portion of the first and shoot.

- You can retake a shot by pressing the  or  button and returning to the previously recorded image screen.
- Minor discrepancies in the overlapping portions can be corrected when the images are stitched together.

## 5 Repeat the procedure for additional images.

- A sequence may contain up to 26 images.
- Press the **MENU** button after the last shot.



- You cannot display the images on a TV when shooting in Stitch Assist mode.
- The settings for the first image are applied to the second image onward.



Use PhotoStitch, a supplied software program, to merge the images on a computer.

# Switching between Focusing Modes



Shooting Mode



You can select between the following two focusing modes according to the AiAF setting.

(No frame)	On	The camera detects the subject and highlights the AF frames, from 9 available points, that it will use to determine the focus.
<input type="checkbox"/>	Off	The camera focuses using the center AF frame. This is convenient for focusing on a specific part of a subject with greater certainty.

## 1 (Rec.) Menu ► [AiAF] ► [On]/[Off].

See *Menus and Settings* (p. 32).

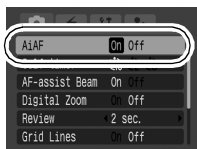

- The focus is locked to the center AF frame when the digital zoom is used.
- The AF frame appears as follows (when the LCD monitor is on) when the shutter button is pressed halfway.
  - Green: Shooting preparations complete
  - Yellow: Focusing difficulty (AiAF set to [Off])



## 4 Re-aim the camera to compose the shot as desired and shoot.

### To Release the AF Lock

Press the  button.



- When shooting with the focus lock or AF lock using the LCD monitor, setting [AiAF] to [Off] (p. 33) makes shooting easier since the camera focuses using the center AF frame only.
- The AF lock is convenient because you can let go of the shutter button to compose the image. Moreover, the AF lock is still effective after the picture is taken, allowing you to capture a second image with the same focus.

## Locking the Exposure Setting (AE Lock)



Shooting Mode



You can set the exposure and focus separately. This is effective when the contrast is too strong between the subject and background or when a subject is backlit.



You must set the flash to . The AE lock cannot be set if the flash fires.

**1 Turn on the LCD monitor.**

**2 Focus on the part of the subject on which you wish to lock the exposure setting.**

**3 Press the shutter button halfway and press the ISO button.**

- The  icon will display.

**4 Re-aim the camera to compose the shot as desired and press the shutter button fully.**



### To Release the AE Lock

Press the ISO button.





- AE lock can also be set and released in  mode (p. 49).
- You can use the FE lock when using the flash.

## Locking the Flash Exposure Setting (FE Lock)

Shooting Mode  



You can lock the flash exposure so that the exposure settings are correctly set regardless of the composition of your subject.

- 1 Turn on the LCD monitor.**
- 2 Press the  button and set it to  (flash on).**
- 3 Focus on the part of the subject on which you wish to lock the flash exposure setting.**
- 4 Press the shutter button halfway and press the ISO button.**
  - The flash will pre-fire and  will display.
- 5 Re-aim the camera to compose the shot as desired and press the shutter button fully.**

**To Release the FE Lock**

Press the ISO button.



# Switching between Metering Modes

Shooting Mode   

## 1 FUNC. Menu \* (Evaluative).



See *Menus and Settings* (p. 31).

\*Default setting.

- Use the  or  button to select the metering mode and press the **FUNC./SET** button.



## Metering Methods

	<b>Evaluative</b>	Appropriate for standard shooting conditions, including backlit scenes. The camera divides images into several zones for metering. It evaluates complex lighting conditions, such as the position of the subject, the brightness, the direct light, and the backlighting, and adjusts the settings to the correct exposure for the main subject.
	<b>Center Weighted Average</b>	Averages the light metered from the entire frame, but gives greater weight to the subject matter at the center.
	<b>Spot</b>	Meters the area within the spot AE point at the center of the LCD monitor. Use this setting when you want to set the exposure on the subject in the center of the monitor.





You can set the shutter speed to a slow setting to make dark subjects appear brighter.

## 1 (Rec.) Menu ► [Long Shutter] ► [On].

See *Menus and Settings* (p. 32).

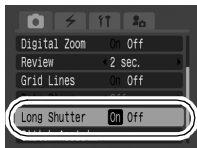

## 2 **FUNC. Menu** ► \* (**Exposure Compensation**)



See *Menus and Settings* (p. 31).

\*Default setting.



## 3 Use the **←** or **→** button to select the shutter speed ► .

- The higher the value, the brighter the image and the lower the value, the darker the image.



### To Cancel the Long Shutter Mode

Press the **MENU** button when the Long Shutter FUNC. menu is displayed.



The nature of CCD image sensors is such that noise in the recorded image increases at long shutter speeds. This camera, however, applies special processing to images shot at shutter speeds slower than 1.3 seconds to eliminate the noise, thereby producing high-quality images. A certain amount of processing time, however, may be required before the next image can be shot.



- Use the LCD monitor to confirm that the image was recorded at the desired brightness.
- Please note that camera shake becomes a factor at low shutter speeds. Secure the camera to a tripod before shooting.
- Use of the flash may result in an over-exposed image. If this occurs, shoot with the flash set to .
- The following are unavailable:
  - Exposure Compensation
  - Metering
  - AE Lock
  - FE Lock
  - ISO speed: Auto
  - Flash: Auto, Auto with Red-Eye Reduction

# Adjusting the Tone (White Balance)

Shooting Mode





Normally, the **AWB** (Auto) white balance setting selects an optimal white balance. When the **AWB** setting cannot produce natural looking colors, change the white balance using a setting appropriate for the light source.

## 1 **FUNC. Menu** **AWB \* (Auto).**







See *Menus and Settings* (p. 31).

\*Default setting.

- Use the  or  button to select a white balance setting and press the **FUNC./SET** button.



## White Balance Settings



	<b>Auto</b>	Settings are automatically set by the camera
	<b>Day Light</b>	For recording outdoors on a bright day
	<b>Cloudy</b>	For recording under overcast, shady or twilight skies
	<b>Tungsten</b>	For recording under tungsten and bulb-type 3-wavelength fluorescent lighting
	<b>Fluorescent</b>	For recording under warm-white, cool-white or warm-white (3-wavelength) fluorescent lighting
	<b>Fluorescent H</b>	For recording under daylight fluorescent, or daylight fluorescent-type 3-wavelength fluorescent lighting
	<b>Custom</b>	For recording with the optimal white balance data retained in the camera from a white-colored object, such as white paper or cloth



This setting cannot be adjusted when the **S** or **BW** photo effect is selected.

## Using the Custom White Balance

You can set a custom white balance to obtain the optimal setting for the shooting conditions by having the camera evaluate an object, such as a piece of white paper or cloth, or a photo-quality gray card that you wish to establish as the standard white color.

In particular, take a custom white balance reading in  (Custom) for the following situations that are difficult for the  (Auto) setting to detect correctly.

- Shooting close-ups
- Shooting subjects of monotone color (such as sky, sea or forest)
- Shooting with a peculiar source of light (such as a mercury-vapor lamp)

### 1 FUNC. Menu ► \* (Auto) ► (Custom).

See *Menus and Settings* (p. 31).



\* Default setting.



### 2 Aim the camera at a piece of white paper or cloth and press .

- If you are viewing it with the LCD monitor, ensure that the center frame is completely filled with the white image. If you are using the optical viewfinder, ensure that the entire field is filled.



- You are recommended to set the shooting mode to  and the exposure compensation setting to  $[\pm 0]$  before setting a custom white balance. The correct white balance may not be obtained when the exposure setting is incorrect (image appears completely black or white).
- Shoot with the same settings as when reading the white balance data. If the settings differ, the optimal white balance may not be set. In particular, the following should not be changed.
  - ISO Speed
  - Flash  
Setting the flash to on or off is recommended. If the flash fires when reading the white balance data with the flash set to  (auto) or  (auto with red-eye reduction), make sure that you also use the flash when you shoot.
- Since the white balance data cannot be read in Stitch Assist mode, preset the white balance in another shooting mode beforehand.
- The camera will retain the custom white balance setting that you record even if you reset the camera to the default settings (p. 37).

# Changing the Photo Effect



Shooting Mode



By setting a photo effect before you shoot, you can change the look and feel of the pictures you take.

## 1 FUNC. Menu \* (Effect Off).

See *Menus and Settings* (p. 31).

\*Default setting.

- Use the or button to select a photo effect and press the **FUNC./SET** button.



## Photo Effect Settings

	<b>Effect Off</b>	Records normally with this setting.
	<b>Vivid</b>	Emphasizes the contrast and color saturation to record bold colors.
	<b>Neutral</b>	Tones down the contrast and color saturation to record neutral hues.
	<b>Low Sharpening</b>	Records subjects with softened outlines.
	<b>Sepia</b>	Records in sepia tones.
	<b>B/W</b>	Records in black and white.









A My Colors mode easily changes the colors in an image when it is shot, allowing you to alter the balance between red, green and blue, transform pale or tanned skin or change a color specified on the LCD monitor into a different color. Since they work with both stills and movies, these modes let you enjoy producing various image or movie effects.

However, depending on the shooting conditions, the images may appear rough or you may not get the expected color. Before you try to photograph important subjects, we highly recommend that you shoot trial images and check the results.

Moreover, the camera will record both the My Colors image and the original unaltered image if you set [Save Original] (p. 65) to [On].

## My Colors Settings

	<b>Positive Film</b>	Use this option to make red, green or blue colors more intense like the Vivid Red, Vivid Green or Vivid Blue effects. It can produce intense natural-appearing colors like those obtained with positive film.
	<b>Lighter Skin Tone*</b>	Use this option to make skin tones lighter.
	<b>Darker Skin Tone*</b>	Use this option to make skin tones darker.
	<b>Vivid Blue</b>	Use this option to emphasize blue tints. It makes blue subjects, such as the sky or ocean, more vivid.
	<b>Vivid Green</b>	Use this option to emphasize green tints. It makes green subjects, such as mountains, new growth, flowers and lawns, more vivid.
	<b>Vivid Red</b>	Use this option to emphasize red tints. It makes red subjects, such as flowers or cars, more vivid.
	<b>Color Accent</b>	Use this option to have only the color specified on the LCD monitor remain and to transform all others to black and white.

<b>BS</b>	<b>Color Swap</b>	Use this option to transform a color specified on the LCD monitor into another. The specified color can only be swapped into one other color, multiple colors cannot be chosen.
<b>BC</b>	<b>Custom Color</b>	Use this option to freely adjust the color balance between red, green, blue and skin tones*. It can be used to make subtle adjustments, such as making blue colors more vivid or face colors brighter.

\* The skin colors of non-human subjects may also be altered.

\* You may not obtain the expected results depending on the skin color.

## 1 **FUNC. Menu** ▶ **BS** (My Colors: Stills)/**BS** (My Colors: Movies).

See *Menus and Settings* (p. 31).

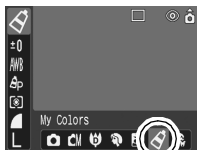

Stills

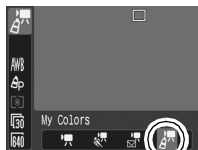

Movies

## 2 **FUNC. Menu** ▶ **BP** \* (Positive Film).

See *Menus and Settings* (p. 31).

\*Default setting.

- Use the ◀ or ▶ button to select a My Colors mode.



## 3 **Shoot.**

- **BP AL AD AB AG AR Modes**

Press the **FUNC./SET** button. The display will return to the shooting screen and you can shoot.

- **BA BS BC Modes**

**BA**: See *Setting the Camera to the Color Accent Mode* (p. 66).

**BS**: See *Setting the Camera to the Color Swap Mode* (p. 67).

**BC**: See *Setting the Camera to a Custom Color Mode* (p. 68).



The ISO speed will rise with some settings, which may increase the “noise” in the image.

## Changing the Save Method for the Original Image

When you are shooting still images in a My Colors mode, you can specify whether or not both the altered image and the original image are recorded.

### 1 (Rec.) Menu ► [Save Original] ► [On]/[Off].

See *Menus and Settings* (p. 32).

- If [On] is selected, the two images will be numbered consecutively with the altered image following the original.



### When [Save Original] is Set to [On]

- Only the altered image is shown on the LCD monitor during shooting.
- The image that appears on the LCD monitor immediately after recording is the altered image. If you erase the image at this point, the original image is erased along with the altered image. Exercise adequate caution before deleting a file.
- Since two images are recorded with each shot, the number of shots remaining is approximately half the number displayed when this function is set to [Off].

## Setting the Camera to the Color Accent Mode

Colors other than the color specified on the LCD monitor are shot in black and white.



### 1 (Color Accent)

See *Menus and Settings* (p. 31).

- The camera will switch to color input mode and the display will alternate between the original image and the color accent image (using the previously set color).



### 2 **Aim the camera so that the color you wish to retain appears at the center of the LCD monitor and press the button.**

- Only one color can be specified.
- You can use the  or  button to specify the range of colors that are retained.
  - -5: Only takes the color that you want to retain
  - +5: Also takes colors close to the one that you want to retain

### 3

- This completes the setting.
- If you press the **MENU** button at this point, you will return to the screen where you can select a My Colors mode.



- The default color accent is green.
- You may not obtain the expected results after color input mode if you use the flash, or change the white balance or metering settings.
- The specified color accent is retained even if the camera's power is turned off.

## Setting the Camera to the Color Swap Mode

This mode allows you to transform a color specified on the LCD monitor into another.

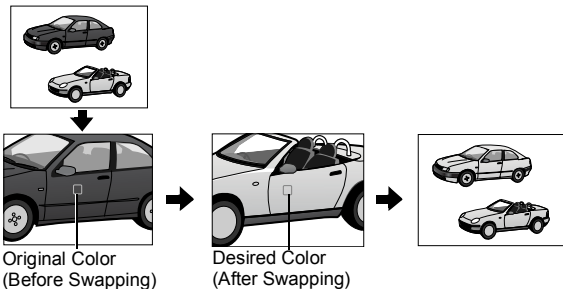

### 1 (Color Swap)

See *Menus and Settings* (p. 31).

- The camera will switch to color input mode and the display will alternate between the original image and the color swap image (using the previously set color).



### 2 Aim the camera so that the original color appears at the center of the LCD monitor and press the **←** button.

- Only one color can be specified.
- You can use the **↑** or **↓** button to specify the range of colors that are swapped.
  - -5: Only takes the color that you want to swap
  - +5: Also takes colors close to the one that you want to swap

### 3 Aim the camera so that the desired color appears at the center of the LCD monitor and press the **→** button.

- Only one color can be specified.

4



- This completes the setting.
- If you press the **MENU** button at this point, you will return to the screen where you can select a My Colors mode.



- The default setting for color swap mode changes green into white.
- You may not obtain the expected results after color input mode if you use the flash, or change the white balance or metering settings.
- The colors specified in the color swap mode are retained even if the camera's power is turned off.

## Setting the Camera to a Custom Color Mode

This mode allows you to adjust the color balance for red, green, blue and skin tones.

1

**CC (Custom Color)** ►

See *Menus and Settings* (p. 31).



2

**Use the  $\uparrow$  or  $\downarrow$  button to select [Red], [Green], [Blue] or [Skin Tone] and the  $\leftarrow$  or  $\rightarrow$  button to adjust the color balance.**

- The altered color will display.



Select a color.      Adjust the color balance.

3







- This completes the setting.
- If you press the **MENU** button at this point, you will return to the screen where you can select a My Colors mode.



Raise the ISO speed when you wish to reduce the effects of camera shake, turn the flash off when shooting in a dark area, or use a fast shutter speed.

## 1 Press the ISO button and switch settings.

- Cycle through the  /  /  /  / [Auto] with each press of the ISO button.
- Selecting [Auto] sets the sensitivity to produce the optimal image quality.

# Setting the Auto Rotate Function



Shooting Mode





Your camera is equipped with an Intelligent Orientation sensor that detects the orientation of an image shot with the camera held vertically and automatically rotates it to the correct orientation when viewing it on the LCD monitor.

## 1 (Set up) Menu ► [Auto Rotate] ► [On]/[Off].

See *Menus and Settings* (p. 32).

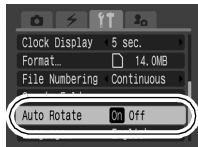
- When the Auto Rotate function is set to [On] and the LCD monitor is set to the detailed display mode, the  (normal),  (right end is down) or  (left end is down) will appear in the display.



- This function may not operate correctly when the camera is pointed straight up or down. Check that the arrow  is pointing in the right direction and if it is not, then set the Auto Rotate function to [Off].
- Even if the Auto Rotate function is set to [On], the orientation of images downloaded to a computer will depend upon the software used to download the images.



- When the camera is held vertically to shoot, the Intelligent Orientation sensor judges the upper end to be “up” and the lower end to be “down”. It then regulates the optimal white balance, exposure and focus for vertical photography. This function operates regardless of the on/off status of the Auto Rotate function.
- When the Auto Rotate function is set to [On] in shooting mode, the orientation of the camera is recorded when the shot is taken.
- When the Auto Rotate function is set to [On] in playback mode, images will be rotated to their correct orientation on the LCD monitor as needed when the camera’s orientation is changed (only applies to images shot when the Auto Rotate function was set to [On]).

# Creating an Image Destination (Folder)



Shooting Mode



You can create a new folder at any time and the recorded images will be automatically saved to that folder.

<b>Create New Folder</b>	Creates a new folder the next time you shoot images. To create an additional folder, insert another check mark.
<b>Auto Create</b>	You can also specify a date and time if you wish to create a new folder using a shooting time after the specified date and time (p. 36).

## 1 [i] (Set up) Menu ► [Create Folder].

See *Menus and Settings* (p. 32).

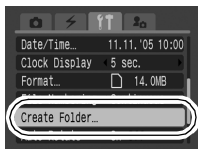

## Creating a folder the next time you shoot

### 2 Use the ← or → button to place a check mark beside [Create New Folder] ► (MENU).

- displays on the LCD monitor. The symbol will cease to display after the new folder is created.

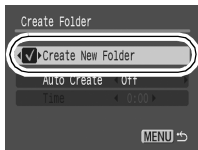

## Setting the Day or Time for Automatic Folder Creation

### 2 Select a day for the [Auto Create] option and a time in the [Time] option ► (MENU).

- displays when the specified time arrives. The symbol will cease to display after the new folder is created.

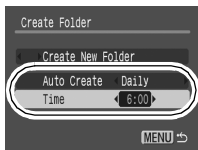



Up to 2000 images can be saved into one folder. A new folder will automatically be created when you record more than that number even if you are not creating new folders.

## Resetting the File Number



Shooting Mode



The images you shoot are automatically assigned file numbers. You can select how the file number is assigned.

### 1 **[i/f] (Set up) Menu ▶ [File numbering] ▶ [Auto reset]/[Continuous].**

See *Menus and Settings* (p. 32).

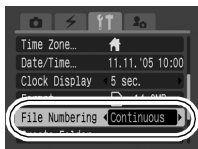

## File Number Reset Function

<b>Continuous</b>	A number one higher than the last one recorded is assigned to the next image. This is convenient for managing all your images together on a computer because you avoid file name duplication when changing folders or memory cards*.
<b>Auto reset</b>	The folder and image number are reset to the starting value (100-0001)*. This is convenient for managing images on a folder-by-folder basis.

\*When a blank memory card is used. If a memory card with recorded data is used, the 7-digit number for the last recorded folder and image is compared with the last one on the card, and the larger of the two is utilized as the basis for new images.

## File and Folder Numbers

Recorded images are assigned consecutive file numbers starting with 0001 and ranging up to 9999, while folders are assigned numbers starting with 100 and ranging up to 999. Up to 2,000 images can be saved into a single folder.

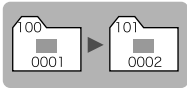
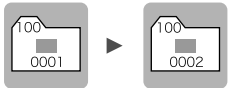
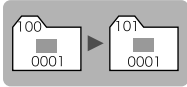
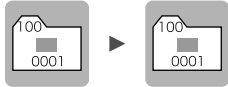
	New Folder Created	Memory Card Exchanged for Another
Continuous	Memory Card 1 	Memory Card 1 Memory Card 2 
Auto Reset	Memory Card 1 	Memory Card 1 Memory Card 2 

- Images may be saved to a new folder when there is insufficient free space even if the total number of images in a folder is less than 2,000 because the following types of image are always saved together into the same folder.
  - Images from continuous shooting
  - Self-timer images (custom)
  - Stitch Assist mode images
  - My Colors images ([Save Original] set to [On])
- Images cannot be played back when the folder numbers are duplicated or image numbers are duplicated within folders.
- Please refer to the *Software & Wireless Guide* for information regarding folder structures or image types.

# Playback/Erasing

Please also see the *Basic Guide* (p. 11).

## 🔍 Magnifying Images

### 1 Press the zoom lever toward 🔍.

- **SET** 📏 will display and a magnified portion of the image will display.
- Images can be magnified up to a factor of approximately 10x.



Approximate Location of the Displayed Area

### 2 Use the ←, →, ↑ or ↓ button to move around the image.

- If you press the **FUNC./SET** button while in magnified display, the camera switches to image advance mode and **SET** 📏 will display. You can use the ← or → button to advance to the next or previous image at the same level of magnification. The image advance mode is canceled when you press the **FUNC./SET** button again.
- You can change the magnification level with the zoom lever.

### To Cancel the Magnified Display





Press the zoom lever toward 📏. (You can also cancel it immediately by pressing the **MENU** button.)



Movie frames and index playback images cannot be magnified.

# Viewing Images in Sets of Nine (Index Playback)





## 1 Press the zoom lever toward .

- Up to nine images can be viewed at once.
- Use the , ,  or  button to change the image selection.



## Switching between Sets of Nine Images

The jump bar will display if you press the zoom lever toward  while in index playback and you can switch the display between sets of nine images.

- Use the  or  button to move to the previous or next set of nine images.
- Hold the **FUNC./SET** button down and press the  or  button to jump to the first or last set.

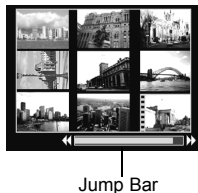





## To Return to Single Image Playback

Press the zoom lever toward .

## Jumping to Images

When you have many images recorded onto a memory card, it is handy to use the five search keys below to jump over images to find the object of your search.

	<b>Jump 10 Images</b>	Jumps over 10 images at a time.
	<b>Jump 100 Images</b>	Jumps over 100 images at a time.
	<b>Jump Shot Date</b>	Jumps to the first image of each shooting date.
	<b>Jump to Movie</b>	Jumps to a movie.
	<b>Jump to Folder</b>	Displays the first image in each folder.

### 1 In single image playback mode, press the button.

- The camera will switch to jump search mode.
- The screen sample will vary slightly according to the search key.



Location of image currently being displayed.

Number of images matching search key.

### 2 Use the or button to select a search key and press the or button.

#### To Return to Single Image Playback

Press the **MENU** button.



# Viewing Movies

! Movies cannot be played in the index playback mode.

## 1 Display a movie and press .

- Images with a  icon are movies.















Movie Control Panel  
Volume Level  
(Adjust with the  or  button)

## 2 Select (Play) and press .

- The movie will pause if you press the **FUNC./SET** button during playback. It will resume when you press the button again.
- When playback ends, the movie stops at the last frame displayed. Press the **FUNC./SET** button to display the movie control panel.

## Operating the Movie Control Panel

	Ends playback and returns to single image playback
	Print (An icon will display when a printer is connected. See the <i>Direct Print User Guide</i> for details.)
	Transfer (An icon will display when a computer is connected. See <i>Software &amp; Wireless Guide</i> for details.)
	Play
	Slow Motion Playback (You can use the  button to slow down or the  button to speed up playback.)
	Displays the first frame
	Previous Frame (Rewinds if the <b>FUNC./SET</b> button is held down)
	Next Frame (Fast Forwards if the <b>FUNC./SET</b> button is held down)
	Displays the last frame
	Edit (Switches to movie editing mode) (p. 78)



- Use the television's controls to adjust the volume when playing a movie on a TV set (p. 93).
- The sound cannot be played in slow motion playback.

## Editing Movies

You can delete portions of recorded movies.



Movies 1 second or longer before editing can be edited, but those that are protected or less than 1 second long cannot be edited.

- 1 Select  (Edit) in the movie control panel and press .**



- The movie editing panel and the movie editing bar will display.

Movie Editing Panel



Movie Editing Bar

- 2 Use the  or  button to select  (Cut Beginning) or  (Cut End) and the  or  button to specify the cut point(.**

- To check a temporarily edited movie, select  (Play) and press the **FUNC./SET** button.
- Selecting  (Exit) cancels the edit and restores the movie control panel.

- 3 Select  (Save) and press .**

## 4 Select [New File] or [Overwrite] and

press  .

- [New File] saves the edited movie under a new file name. The pre-edit data is left unchanged.

Note, if you press the **FUNC./SET** button while saving the movie, saving is canceled.

- [Overwrite] saves the edited movie with its original name. The pre-edit data is lost.
- When there is not enough space left on the memory card, only [Overwrite] can be selected.



It may take approximately 3 minutes to save an edited movie. If the battery runs out of charge partway through, edited movie clips cannot be saved. When editing movies, it is recommended to use a fully charged battery or the separately sold AC Adapter Kit ACK-DC10 ([p. 123](#)).

# Rotating Images in the Display

Images can be rotated clockwise 90° or 270° in the display.

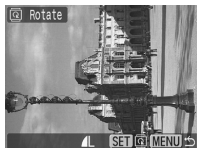

Original



90°



270°

## 1 (Play) Menu .

See *Menus and Settings* (p. 32).

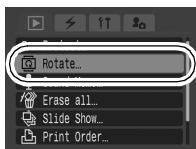

## 2 Use the or button to select an image to rotate and press to rotate it.





- Cycle through the 90°/270°/original orientations with each press of the **FUNC./SET** button.
- This also can be set in the index playback mode.



- Movies cannot be rotated.
- When images are downloaded to a computer, the orientation of images rotated by the camera will depend upon the software used to download the images.

## Playback with Transition Effects

You can select the transition effect displayed when switching between images.

	Usual display
	The displayed image darkens and the next image gradually brightens until it is displayed.
	Press the  button to have the previous image display from the left and the  button to have the next image display from the right.

### 1 **(Play) Menu**

See *Menus and Settings* (p. 32).



The transition effect will not display when an image is switched while the camera is reading an image from the memory card.

## Attaching Sound Memos to Images

In playback mode (including single image playback and index playback), you can attach sound memos (up to 60 seconds) to an image. The sound data is saved in the WAVE format.

### 1 **(Play) Menu**

See *Menus and Settings* (p. 32).

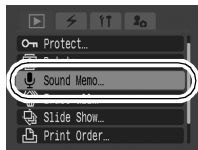

## 2 Use the ← or → button to select an image to attach a sound memo to and press .

- The sound memo panel will display.





## 3 Select (Record) and press .

- The elapsed time and the remaining time display.
- Pressing the **FUNC./SET** button pauses the recording. Pressing it again resumes recording.
- Up to 60 seconds of recordings can be added to any one image.



Sound Memo Panel  
Elapsed Time/  
Remaining Time  
Volume  
(Adjust with the ↑ or  
↓ button)

## Sound Memo Panel







	Exit
	Record
	Pause
	Play
	Erase
	Select [Erase] in the confirmation screen and press the <b>FUNC./SET</b> button.

- You cannot attach sound memos to movies.
- Sound memos for protected images cannot be erased.

# Automated Playback (Slide Shows)

Automated Playback of Memory Card Images.

Image settings for slide shows are based on the Digital Print Order Format (DPOF) standard (p. 88).





	<b>All Images</b>	Plays all images on a memory card in order.
	<b>Date</b>	Plays images bearing a specified date in order.
	<b>Folder</b>	Plays images in a specified folder in order.
	<b>Movie</b>	Plays movie files only, in order.
	<b>Stills</b>	Plays still images only, in order.
	<b>Custom 1-3</b>	Plays the images selected for each slide show, Custom 1, Custom 2 or Custom 3, in order (p. 85).



## 1 (Play) Menu .

See Menus and Settings (p. 32).



## 2 **Select** , , , , or .

- For  or , select the image date or folder to be played back (p. 85).
- For ,  or , select the images to be played back (p. 85).

- If you want to add a transition effect to play back images, use the  button to select [Effect] and choose the type of effect with the  or  button (See the next page).

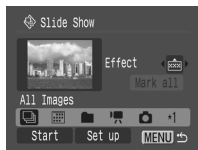

## 3





**Select [Start] and press .**

- The following functions are available during slide shows.
  - Pausing/resuming the slide show: press the **FUNC./SET** button
  - Fast forwarding/rewinding the slide show: press the **◀** or **▶** button (continue to hold the button to switch between images more rapidly)
  - Stopping the slide show: press the **MENU** button.



## Transition Effects

You can select the transition effect used when one image is replaced by another.

	Usual display
	The new image gradually brightens as it moves upward from the bottom.
	The new image first appears in a cross shape and gradually expands to display the full image.
	Portions of the new image move horizontally, then the image expands to display the full image.



In single image playback mode (when displaying a still image), you can start a slide show from the current image displayed by holding the **FUNC./SET** button while you press the  button. Please note that if you do this while the last image shot is displayed, the slide show will start from the first image using the same date.

## Selecting an Image Date or Folder for Playback ( / )

**1** Select  or  and press .

**2** Use the **←** or **→** button to select the date or folder to be played back and press .



Date

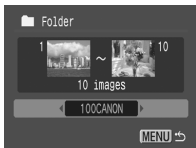

Folder

## Selecting Images for Playback (\*1-3)

Select only the images that you wish to play back and save them as a slide show (Custom 1, 2 or 3). Up to 998 images can be selected. They will be played back in their order of selection.

**1** Select \*1, \*2 or \*3 and press .

- Only the \*1 icon will display at first. When you set \*1, the icon will change to  and \*2 will display. \*2 and \*3 will change in the same way when they are set.

**2** Use the **←** or **→** button to move between images for playback and the  button to select or deselect them.

- You can also select images in the index playback mode.
- Pressing the **MENU** button cancels the setting.

Check mark indicating selection

Number indicating the selection order





### Selecting All Images

1. After selecting **1**–**3** in step 1 (p. 85), use the **▲** button to select [Mark all] and press the **FUNC./SET** button.
  2. Use the **▲** button to select [Mark all], press the **FUNC./SET** button.
  3. Use the **▶** button to select [OK] and press the **FUNC./SET** button.
- To deselect all images, select [Reset].

## Adjusting the Play Time and Repeat Settings

### ● Play Time

Sets the duration that each image displays. Choose between 3–10 seconds, 15 seconds and 30 seconds. Displaying time can vary slightly depending on the image.

### ● Repeat

Sets whether the slide show stops when all the slides have been displayed or continues until stopped.

**1** Select [Set up] and press .

**2** Select [Play Time] or [Repeat] and then the desired option.

- Pressing the **MENU** button cancels the setting.

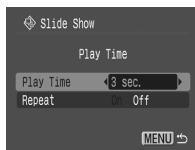

# Protecting Images

You can protect important images and movies from accidental erasure.

## 1 (Play) Menu .

See *Menus and Settings* (p. 32).



## 2 **Select an image to protect and press** .

- Pressing the **FUNC./SET** button again cancels the setting.
- You can also protect images in the index playback mode.



Protection Icon

# Erasing All Images



- Note that erased images cannot be recovered. Exercise adequate caution before erasing an image.
- Protected images cannot be erased with this function.

## 1 (Play) Menu .

See *Menus and Settings* (p. 32).

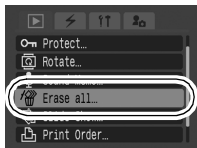

## 2 **Select [OK] and press** .

- To exit instead of erasing, select [Cancel].



Please format the memory card when you want to erase not only image data but also all the data contained on the card (p. 28).

## Setting the DPOF Print Settings

You can select images on a memory card for printing and specify the number of print copies in advance using the camera. This is extremely convenient for printing on a direct print compatible printer, or for sending the images to a photo developing service that supports DPOF.

The  icon may display for a memory card with print settings set by a different DPOF-compliant camera. These settings will be overwritten by those set by your camera.

### 1 (Play) Menu .

See *Menus and Settings* (p. 32).

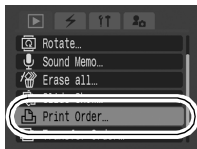

## Single Images

### 2 Select [Order] and press .

- Selecting [Reset] cancels all print settings for the images.

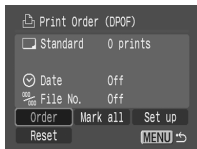

### 3 Select images for printing.

- Selection methods differ for the Print Type settings (p. 90).
  -  (Standard)/ (Both)  
Select an image, press the **FUNC./SET** button and use the **↑** or **↓** button to select the number of print copies (up to 99).
  -  (Index)  
Select an image and the press **FUNC./SET** button to select or deselect it.
- You can also select images in the index playback mode.

Number of Print Copies



Index Print Selection



## All the Images on a Memory Card

### 2 Select [Mark all] and press .

- Selecting [Reset] cancels all print settings for the images.
- One copy of every image will be set to print.

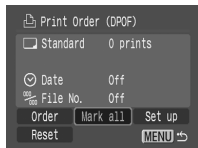

### 3 Select [OK] and press .



- The output of some printers or photo developing services may not reflect the specified print settings.
- Print settings cannot be set for movies.



- Images are printed in order according to the file number.
- A maximum of 998 images can be selected.
- When [Print Type] is set to [Both], the number of copies can be set. When it is set to [Index], the number of copies cannot be set (only one copy will be printed).
- Do not set the date in the DPOF print settings when printing images that have had the date embedded with the [Date Stamp] function. This may cause the date to be printed twice.

## Setting the Print Style

The following print styles can be selected.

Print Type	<input checked="" type="checkbox"/> Standard	Prints one image per page.
	<input type="checkbox"/> Index	Prints the selected images together at a reduced size in an index format.
	<input checked="" type="checkbox"/> Both	Prints the images in both the standard and index formats.
<input checked="" type="checkbox"/> Date		Adds the date to the print.
<input checked="" type="checkbox"/> File No.		Adds the file number to the print.

### 1 (Play) Menu .

See *Menus and Settings* (p. 32).



### 2 Select [Set up] and press .

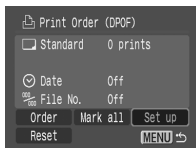

### 3 Select [Print Type], [Date] or [File No.] and then specify the settings.



- The Date and File No. settings change according to the Print Type as follows.
  - Index  
[Date] and [File No.] cannot be set to [On] at the same time.
  - Standard or Both  
[Date] and [File No.] can be set to [On] at the same time. However, the printable information may vary between printers.
- Embedded dates in  (Postcard Date Imprint mode) (p. 44) print out even when [Date] is set to [Off].
- Dates print in the style specified in the [Date/Time] menu (p. 35).

## Setting the DPOF Transfer Settings

You can use the camera to specify settings for images before downloading to a computer. Refer to the *Software & Wireless Guide* for instructions on how to transfer images to your computer.

The settings used on the camera comply with the Digital Print Order Format (DPOF) standards.

**The  icon may display for a memory card with transfer settings set by a different DPOF-compliant camera. These settings will be overwritten by those set by your camera.**

### 1 (Play) Menu .

See *Menus and Settings* (p. 32).



## Single Images

### 2 Select [Order] and press .

- Selecting [Reset] cancels all transfer order settings.

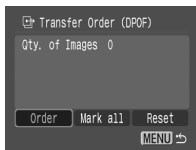

### 3 Select an image to transfer and press .

- Pressing the **FUNC./SET** button again deselects the setting.
- You can also select images in the index playback mode.

Transfer Selection



## All the Images on a Memory Card

### 2 Select [Mark all] and press .

- Selecting [Reset] cancels all transfer order settings.



### 3 Select [OK] and press .



- Images are transferred in order according to the file number.
- A maximum of 998 images can be selected.

# Viewing Images on a TV set

You can use a video-compatible television as a monitor to shoot or play back images when it is connected to the camera with the supplied AV Cable.

## 1 Turn off the Camera and the TV.

## 2 Connect the AV cable to the camera's A/V OUT terminal.

- Slide the terminal cover open and firmly insert the AV cable.

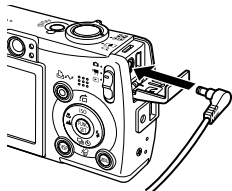

## 3 Plug the other ends of the AV cable to the VIDEO IN and AUDIO IN jacks on the TV.

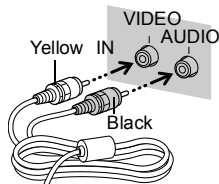

## 4 Turn on the TV and switch it to video mode.

## 5 Turn on the camera.



The video output signal can be switched (NTSC or PAL) to accommodate different regional standards (p. 36). The default setting varies between regions.

- NTSC: Japan, U.S.A., Canada, Taiwan and others
- PAL: Europe, Asia (excluding Taiwan), Oceania and others

If the video system is set incorrectly, the camera output may not display properly.

# Customizing the Camera (My Camera Settings)

My Camera allows you to customize the start-up image and start-up, operation, self-timer and shutter sounds. You can change and register these settings, enabling you to customize the camera to suit your own tastes.

## Changing My Camera Settings

### 1 (My Camera) Menu ► Menu Item.

See *Menus and Settings* (p. 32).



### 2 **Select the contents you wish to set.**

- Select [Theme] to set all to the same settings.

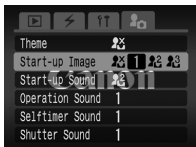

# Registering My Camera Settings

Images recorded onto the memory card and newly recorded sounds can be added as My Camera settings to the **[2]** and **[3]** menu items. You can also use the supplied software to upload your computer's images and sounds to the camera.



A computer is required to restore the My Camera settings to the defaults. Use the supplied software (ZoomBrowser EX/ImageBrowser) to restore the default settings to the camera.

## 1 Slide the mode switch to **[▶ (playback)]** **[My Camera] Menu** **[Menu Item]** to register.

See *Menus and Settings* (p. 32).

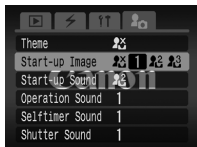

## 2 Select **[2]** or **[3]** and press **(DISP.)**.

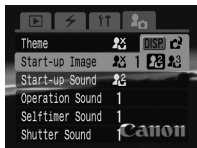

### 3 Select an image or record a sound.

#### ● Start-up Image

Select the image you wish to register and press the **FUNC./SET** button.



#### ● Start-up, Operation, Self-timer and Shutter Sounds

Select  (Record) and press the **FUNC./SET** button. After recording, select  (Register) and press the **FUNC./SET** button.



- Recording will automatically stop when the recording time elapses.
- To play it, select  (Play).
- To exit instead of registering, press  (Exit).

### 4 Select [OK] and press .

- To cancel registering, select [Cancel].



- The following cannot be registered as My Camera settings.
  - Movies
  - Sounds recorded with the sound memo function (p. 81)
- The prior setting is erased when a new My Camera setting is added.



See the supplied *Software & Wireless Guide* for more information on creating and adding to the My Camera data.

# Using Wireless Connection (Connecting to Printer)

When you want to save or print your images, this camera lets you transfer them to a personal computer or printer wirelessly, without the need for cables.

## Connecting to a Printer

If you attach the supplied wireless print adapter to a Canon *PictBridge* compliant printer, you can print images taken with the camera after transferring them to the printer over a wireless connection. (p. 98)

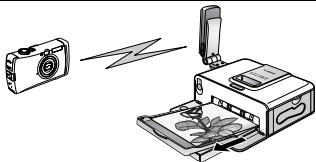

See the instructions, beginning on the next page.

## Connecting to a Computer

If you install the software included on the Canon Digital Camera Solution Disk on a wireless capable computer\*, you can establish a wireless connection between the camera and the computer.

If you set up a wireless connection to a computer, you can transfer images you have already taken to the computer, but you can also shoot images and transfer them to the computer immediately (Auto Transfer), automatically print out transferred images, and even shoot images by operating the computer.

\* Connecting wirelessly between the camera and a computer is only possible with the Windows XP SP2 operating system.

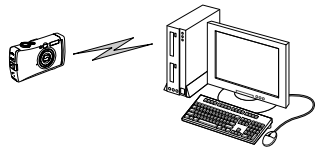

Please refer to the *Software & Wireless Guide*.



If your printer is not a Canon *PictBridge* compliant printer, you can still print your images easily by using the cable to connect the camera and printer. Please see the *Direct Print User Guide* for more details.



## Attaching the wireless print adapter to a printer

If you attach the supplied Wireless Print Adapter WA-1 to a Canon *PictBridge* compliant printer, you can print the images stored on your camera's memory card via a wireless connection.



Do not connect the wireless print adapter to a computer as doing so may cause the computer to malfunction. The wireless print adapter is only intended for Canon *PictBridge* compliant printers.

### 1 Adjust the angle and direction of the wireless print adapter.

- The wireless print adapter can be turned or rotated as shown in the illustration.
- Set the orientation of the wireless print adapter's USB terminal so that it can be inserted into your printer's USB port.
- Do not use unnecessary force when adjusting the angle and direction of the wireless print adapter.

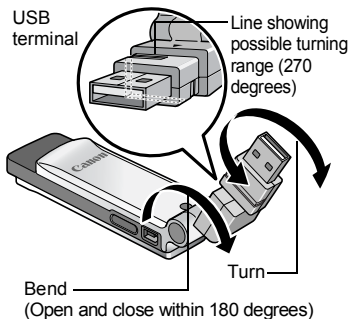

## 2 Attach the supplied compact power adapter to the wireless print adapter.

- Insert the compact power adapter cable firmly into the wireless print adapter's DC IN terminal.
- Attach the compact power adapter CA-DC20 if you are using a Canon *PictBridge* Compliant printer other than a CP710/CP510. You do not need to use the compact power adapter CA-DC20 if you are using CP710/510.
- Always hold the side of the cable's connector when removing the compact power adapter cable from the wireless print adapter.

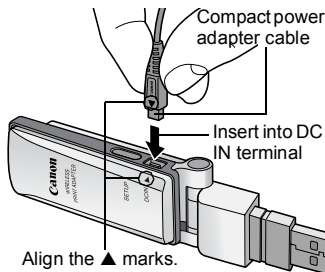

## 3 Insert the compact power adapter into the power outlet.

## 4 Attach the wireless print adapter to the printer's USB port.

- In order to improve the quality of the connection, we recommend turning the wireless print adapter through 90 degrees before attaching it to the printer.

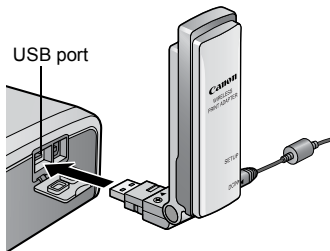

## 5 Turn on the printer.

# Connecting/Disconnecting





## Setting up a wireless connection to a printer



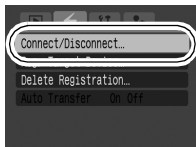



- 1** Slide the mode switch to  (playback)   
 (Wireless) Menu  [Connect/Disconnect]

See *Menus and Settings* (p. 32).

- Even if you press the  button without displaying the menu in playback mode, the same screen will be displayed.



- 2** After confirming that [1.WA-1] is selected as the [Target Device], use the  or  buttons to select [Connect] and press  (or ).

- The monitor will display “Connecting”, and soon the connection will be complete.
- If a device other than [1.WA-1] is selected as the target device, use the  or  button to select [Target Device], then use the  or  button to select [1.WA-1].
- In situations where a number of wireless print adapters are available for connection (have been registered as target devices) (p. 102), select the wireless print adapter you wish to connect to as the target device.
- When the wireless connection starts, the camera’s wireless lamp and the wireless print adapter’s lamp will both begin to blink blue. When the wireless connection has been completed, both lamps will remain on (without blinking).
- You can also start a wireless connection without using the menus by continually pressing the  button.
- When the wireless connection has been completed, the  icon will display. This shows the strength of the connection’s radio waves.
- If a connection cannot be completed due to weak radio waves or some other reason, the connection will automatically be terminated after 30 seconds.





For instructions on how to print once you have set up a wireless connection, please refer to the *Direct Print User Guide*.

## Ending the wireless connection



- 1 Slide the mode switch to  (playback)   
 (Wireless) Menu  [Connect/Disconnect]

See *Menus and Settings* (p. 32).

- 2 Use the  or  button to select [Disconnect], then press .

- The wireless connection will end.



- If  displays during wireless connection, it means that the connection is very good. The fewer the antennas displayed, the worse the wireless connection is. When  and the wireless lamp both blink, it indicates an extremely bad connection. In such a case, shorten the distance between the camera and the wireless adapter.
- Please be aware of the points below when using a wireless connection between the camera and a printer. Failure to follow these instructions may terminate the connection.
  - Do not use a wireless connection near to a microwave oven or any other appliance which emits electromagnetic waves.
  - Do not put the camera and the printer far apart.
  - Do not place objects in between the camera and printer.
- If a number of wireless print adapters are available for connection, select [Target Device] and press the **DISP.** button to confirm which wireless print adapter you can connect to. The lamp on the available adapter will blink in the following sequence: blue, blue, orange.
- If you slide the mode switch while using a wireless connection to a printer, the wireless connection will be terminated.
- If you end the wireless connection while printing, printing will be interrupted.

## Changing the wireless print adapter channel

If the wireless print adapter channel (useful frequency) is already in use by another device, change the channel to avoid interference from radio waves.

- 1 Select the target device for which you wish to change the channel in [Target Device] and press .**

See *Menus and Settings* (p. 32).



- 2 Use the  $\uparrow$  or  $\downarrow$  buttons to change the channel and press .**

- Press the **MENU** button to return to step 1 without changing the channel.



- You cannot change the channel during a wireless connection.

## Registering a target device

To set up a wireless connection to a printer using a wireless print adapter other than the supplied adapter, you will need to register the other adapter with the camera as a new target device.

- 1 Attach the compact power adapter to the new wireless print adapter which you wish to register with the camera.**

**2 Slide the mode switch to  (playback)   (Wireless) Menu  [Reg. Target Device].**

See *Menus and Settings* (p. 32).



**3 When the message “Press the SETUP button” is displayed in LCD monitor, press the wireless print adapter’s SETUP button within 10 seconds.**

- The message “Registration completed” will appear on the LCD monitor.
- The newly registered wireless print adapter will be displayed on [Target Device] as [2.WA-1]. Subsequent wireless print adapters will be displayed as [3.WA-1], [4.WA-1] and so on.

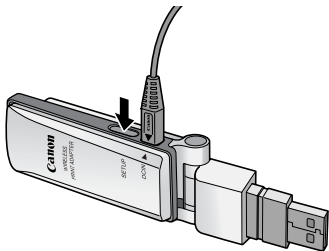

**4 Press .**



- When registering the wireless print adapter, make sure it is within 1 meter of the camera.
- If the registration fails, please refer to *List of Messages* (p. 115).
- You can register up to 8 adapters with the camera.

You can delete devices which you no longer use.

## 1 (Wireless) Menu ► [Delete Registration]

See *Menus and Settings* (p. 32).

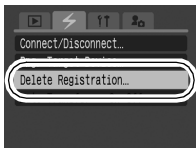

## 2 **Select the target device you wish to delete.**

- Use the **↑** or **↓** button to select [Target Device], and the **←** or **→** button to select the target device you wish to delete.

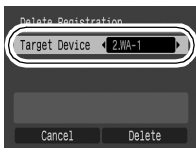

## 3 **Use the **↑**, **↓**, **←** or **→** button to select [Delete], then press .**

- If you want to cancel instead of deleting, select [Cancel].



- You cannot delete the wireless print adapter provided with the camera.

# Troubleshooting

## Camera

### Camera will not operate.

Power is not turned on.	● Press the power button ( <i>Basic Guide</i> p. 5).
Memory card slot/battery cover is open.	● Confirm that the memory card slot/ battery cover is securely closed ( <i>Basic Guide</i> p. 2).
Insufficient battery voltage ("Change the battery pack" message displays).	● Insert a fully charged battery into the camera ( <i>Basic Guide</i> p. 2). ● Use the AC Adapter Kit ACK-DC10 (sold separately) (p. 123).
Poor contact between camera and battery terminals.	● Polish the terminals with a soft cotton swab before charging or using the battery (p. 119).

### Sounds come from the camera interior.

The camera's horizontal/ vertical orientation was changed.	● The camera's orientation mechanism is operating. There is no malfunction.
--	---

## When the power is turned on

### "Card locked!" message appears.

The SD memory card's write protect tab is set to "Write protect".	● When recording to, erasing from or formatting the SD memory card, slide the tab upward (p. 121).
---	--

### The Date/Time menu appears.

The built-in rechargeable lithium battery charge is low.	● Recharge the built-in battery immediately ( <i>Basic Guide</i> p. 4).
--	---

# LCD monitor

## The display darkens.

The image on the LCD monitor will darken in strong sunlight or bright light.

- This does not constitute a malfunction and has no effect on images that have been shot.

## Display flickers.

Display flickers when shot under fluorescent lighting.

- This is not a camera malfunction (flickering recorded in movies, but not in still images).

## A bar of light (red, purple) appears on the LCD monitor.

Subject is too bright.

- This is a normal occurrence in devices containing CCDs and does not constitute a malfunction. This bar of light will not be recorded when shooting still photos, but it will be recorded when shooting movies.

## appears.

A slow shutter speed has likely been selected because of insufficient lighting.

- Raise the ISO speed (p. 69) or set the flash to any setting other than  (flash off), or secure the camera to something, such as a tripod (*Basic Guide* p. 9).

## appears.

This displays when using a memory card that has print settings, transfer settings or slide show image selections set by other DPOF-compliant cameras.

- These settings will be overwritten by those set by your camera (p. 88).

## Noise displays./Subject's movements are irregular.



Camera automatically lightened the image displayed on the LCD monitor to make it easier to see when shooting in a dark area (p. 21).

- There is no effect on the recorded image.

## Shooting

### Camera will not record.

Mode switch is set to  (playback).

- Set the mode switch to  (Rec.) or  (Movie) (*Basic Guide* p. 6).

Flash is charging.

- When charging is complete, the indicator will light orange and you are free to start shooting (p. 26).

Memory card is full.

- Insert a new memory card (*Basic Guide* p. 2).
- If required, download the images to a computer and erase them from the memory card to make space.

Memory card is not formatted correctly.

- Format the memory card (p. 28).
- If reformatting does not work, the memory card logic circuits may be damaged. Consult the nearest Canon Customer Support Help Desk.

SD memory card is write protected.

- Slide the write protect tab of the SD memory card upward (p. 121).

### Image Seen in Viewfinder vs. Recorded Image

Usually the recorded image contains more of the scene than is seen in the viewfinder.

- Confirm the actual image size with the LCD monitor. Use the LCD monitor when taking close-up shots (p. 19).

## Image is blurred or out of focus.

AF-assist Beam is set to [Off].	<ul style="list-style-type: none"><li>● In dark places where it is difficult for the camera to focus, the AF-assist Beam will emit to assist focusing. As the AF-assist Beam will not function when turned off, set it [On] to activate it (p. 33). Take care not to obstruct the AF-assist Beam with your hand when used.</li></ul>
The camera moves when the shutter button is pressed.	<ul style="list-style-type: none"><li>● Setting the self-timer to  (2 seconds) delays the shutter release for 2 seconds and allows the camera to stop shaking, thus preventing a blurred image (p. 45). Even better results can be obtained by placing the camera on a stable surface or by using a tripod to shoot.</li></ul>
Subject is out of focal range.	<ul style="list-style-type: none"><li>● Shoot with the subject at the correct shooting distance (p. 127).</li></ul>
The subject is hard to focus on.	<ul style="list-style-type: none"><li>● Use the focus lock or AF lock to shoot (p. 52).</li></ul>

## Subject in recorded image is too dark.

Insufficient light for shooting.	<ul style="list-style-type: none"><li>● Set the flash to  (flash on) (<i>Basic Guide</i> p. 9).</li></ul>
Subject is dark in contrast to the background.	<ul style="list-style-type: none"><li>● Set the exposure compensation to a positive (+) setting (p. 56).</li><li>● Use AE lock or use the spot metering function (pp. 53, 55).</li></ul>
Subject is too far away for flash to reach.	<ul style="list-style-type: none"><li>● Shoot within correct shooting distance of the subject when using the built-in flash (p. 128).</li><li>● Raise the ISO speed and then shoot (p. 69).</li></ul>

### Subject in recorded image is too bright.

Subject is too close, making the flash too strong.

- Shoot within correct shooting distance of the subject when using the built-in flash (p. 128).

Subject is bright in contrast to the background.

- Set the exposure compensation to a negative (-) setting (p. 56).
- Use AE lock or use the spot metering function (pp. 53, 55).

Too much light is shining directly into the camera, or is being reflected off the subject.





- Change the shooting angle.

Flash is set to on.

- Set the flash to  (flash off) (*Basic Guide* p. 9).

### Image flashes white. Image contains noise.

ISO speed is too high.

- Higher ISO speeds increase image noise. To take clean images, use as low an ISO speed as possible (p. 69).
- In , ,  and  modes, the ISO speed increases and noise can appear.

### White dots appear on the image.

Light from the flash has reflected off dust particles or insects in the air. This is particularly noticeable when shooting using the wide angle.

- This is a phenomenon that occurs with digital cameras and does not constitute a malfunction.

### Eyes appear red.

Light reflecting back from eyes can make them appear red when the flash is used in dark areas.

- Use the  (auto with red-eye reduction) mode (*Basic Guide* p. 9). For this mode to be effective, the subject must be looking right at the red-eye reduction lamp. Try asking them to look directly at the lamp.
- Even better results can be obtained by increasing the lighting in indoor settings or approaching closer to the subject. The shutter will not activate for approximately 1 second after the red-eye reduction lamp fires in order to improve the effect.

### Continuous shooting slows down.

The memory card's performance has dropped.

- To enhance the continuous shooting performance, you are recommended to format the memory card in the camera after you save all its images to your computer (p. 28).

### Recording images to memory card takes a long time.

Memory card was formatted in another device.

- Use a memory card formatted in your camera (p. 28).

### Lens will not retract.

Memory card slot/battery cover was opened with power on.

- First close the memory card slot/battery cover and then turn the power off (*Basic Guide* p. 2).

# Shooting Movies

## The recording time may not display properly or filming may stop unexpectedly.

The following types of memory cards are used.

- Slow recording cards.
- Cards formatted on a different camera or a computer.
- Cards which have had images recorded and erased repeatedly.

● Although the recording time may not display properly during shooting, the movie will be recorded correctly on the memory card. Recording time will display properly if you format the memory card in this camera (excluding slow recording memory cards) (p. 28).

## "!" displays frequently on the LCD monitor.

If free space in the camera's built-in memory becomes too scarce, the "!" symbol will display on the LCD monitor in red and the camera will automatically cease filming shortly thereafter.

● Try the following procedures.

- Reformat the memory card before filming (p. 28).
- Lower the recording pixels or frame rate (p. 40).
- Use a high-speed memory card (SDC-512MSH, etc.).

## Zoom does not operate.

Zoom lever was pressed while shooting in movie mode.

● Operate the zoom before shooting in movie mode (*Basic Guide* p. 8). Note the digital zoom is available while shooting, but only in Standard movie mode (p. 42).

# Playback

## Cannot play back.

You attempted to play back images shot with another camera or images edited with a computer.

- Computer images that cannot be played back will play back if they are added to the camera using the supplied software program ZoomBrowser EX or ImageBrowser.

File name was changed with a computer or file location was changed.

- Set the file name or location on the file format/structure of the camera (Refer to the *Software & Wireless Guide* for details).

## Movies cannot be edited.

Some movies shot with another camera cannot be edited.

## Movies do not play back correctly.

Movies recorded with high recording pixels and frame rates may momentarily stop playing if played on slow reading memory cards.

You may experience frame dropping and audio breakup when playing back a movie on a computer with insufficient system resources.

Movies recorded at the  (Fast Frame Rate) setting and with the video signal set to the PAL format, may play back with a frame rate lower than the recorded one when output to a TV or video. You can play every frame by using the slow motion playback.

- To check the images at the original frame rate, you are recommended to play the movie back on the camera's LCD monitor or on a computer.

### Reading images from memory card is slow.

Memory card was formatted in another device.

- Use a memory card formatted in your camera (p. 28).

## Battery/Battery Charger

### Battery consumed quickly.

Battery life exceeded if battery loses its charge quickly at normal temperature (23 °C/73 °F).

- Replace the battery with a new one (*Basic Guide* p. 2).

### Battery will not charge.

Battery life exceeded.

- Replace the battery with a new one (*Basic Guide* p. 2).

## TV monitor output

### Image not showing on TV monitor.

Incorrect video system setting.

- Set the video system to the appropriate setting, NTSC or PAL, for your TV (p. 36).

Shooting in Stitch Assist mode.

- The output will not appear on a TV in Stitch Assist mode. Cancel the Stitch Assist mode (*Basic Guide* p. 6).

## Wireless connection to a printer

### Wireless connection to a printer is not possible.

You have not attached the wireless print adapter to the printer.

- Attach the wireless print adapter to the printer (p. 98).

Your printer is not a Canon *PictBridge* compliant printer.

- When using a wireless connection between the camera and printer, ensure you are using a Canon *PictBridge* compliant printer (p. 98).

You have not attached the compact power adapter to the wireless print adapter.

- If you are using a Canon *PictBridge* compliant printer (other than a CP710/CP510), please attach the CA-DC20/CA-DC20E compact power adapter.

The wireless connection has become weak.

- Do not use near a microwave oven or any other device that emits radio waves.
- Do not put the camera and the printer far apart.
- Do not place anything between the camera and the printer.

# List of Messages

- During shooting, playback, or wireless connection to a printer → The error messages shown below will be displayed.
- During wireless connection to a computer → Please refer to the *Software & Wireless Guide*.
- During printing → Please refer to the *Direct Print User Guide*.

## Busy...

- Image is being recorded to, or read from, memory card. The playback mode is starting up.

## No memory card

- You turned on the camera without a memory card installed.

## Card locked!

- The SD memory card is write-protected.

## Cannot record

- You attempted to shoot an image without a memory card installed, or attempted to attach a sound memo to a movie.

## Memory card error

- Memory card has experienced an anomaly.

## Memory card full

- Memory card is full of images and no more can be recorded or saved. Or no more image settings or sound memos can be recorded.

## Naming error!

- The image could not be created because there is an image with the same name as the folder that the camera is attempting to create, or the highest possible file number has already been reached. In the Set up menu, set the [File Numbering] option to [Auto Reset]. Save all the images you wish to retain onto a computer, then reformat the memory card. Please note that formatting will erase all the existing images and other data.

### **Change the battery pack.**

- Battery charge is insufficient to operate the camera. Replace it at once with a charged one or recharge the battery.

### **No image.**

- No images recorded on memory card.

### **Image too large.**

- You attempted to play back an image larger than 4992 × 3328 pixels or with a large data size.

### **Incompatible JPEG format.**

- You attempted to play back an incompatible JPEG image.

### **Corrupted Data.**

- You attempted to play back an image with corrupted data.

### **RAW**

- You attempted to play back a RAW image.

### **Unidentified Image**

- You attempted to play back an image that was recorded in a special data type (proprietary data type used by the camera of another manufacturer, etc.) or a movie clip recorded by another camera.

### **Cannot magnify!**

- You attempted to magnify an image recorded in a different camera or data type, an image edited with a computer, or a movie.

### **Cannot rotate**

- You attempted to rotate an image recorded in a different camera or data type, an image edited with a computer, or a movie.

### **Incompatible WAVE format.**

- A sound memo cannot be added to this image since the data type of the existing sound memo is incorrect.
-

### Cannot register this image!

- You attempted to register an image recorded in a different camera or a movie as a start-up image.

### Protected!

- You attempted to erase or edit a protected image, movie or sound memo.

### Too many marks.

- Too many images have been marked with print settings, transfer settings or slide show settings. Cannot process any more.

### Cannot complete!

- Could not save the print, transfer or slide show settings.

### Unselectable image.

- You attempted to set the print settings for a non-JPEG image.

### Exx

- (xx: number) Camera malfunction. Turn the power off and then back on, then shoot or play back. A problem exists if the error code reappears. Note the number and contact your Canon Customer Support Help Desk. If an error code displays directly after taking a picture, the shot may not have been recorded. Check image in playback mode.

### Connection has failed x

- Wireless connection has failed. Please follow the instructions below corresponding to the number shown in the error message.

1 2 3	An error has occurred when you set up a wireless connection to a computer. Please refer to the <i>Software &amp; Wireless Guide</i> .
4 5	Wireless connection has failed. Either shorten the distance between the camera and the wireless print adapter; change the orientation of the camera or the angle of the wireless print adapter; or change the channel settings. Then establish a wireless connection again.
7	When a large volume of images (around 1,000) is stored on the memory card, it may not be possible to establish a wireless connection. In such a case, use a memory card reader to store the necessary images in a computer, then reduce the images on the memory card and try again to establish a wireless connection.

## Disconnected

- Wireless connection has disconnected. Either shorten the distance between the camera and the wireless print adapter; change the orientation of the camera or the angle of the wireless print adapter; or change the channel settings. Then establish a wireless connection again.

## Too many devices registered

- 8 target devices are already registered. If you wish to register additional devices, use [Delete Registration] to delete target devices you no longer use.

## Registration failed

- Registration has failed. Either shorten the distance between the camera and the wireless print adapter, or change the orientation of the camera or the angle of the wireless print adapter. Then carry out registration again. Also, if “Press the SETUP button” appears on the LCD monitor at the time of registration, press the camera’s SETUP button within 10 seconds.

## Already registered

- Registration of the same wireless print adapter has already been completed.
-

## Battery Handling

### Battery Charge

The following icon and message will display.



Battery charge is low.  
Recharge it as soon as possible it will be used for an extended period.

#### Change the battery pack

Battery charge is insufficient to operate the camera. Replace the battery immediately.

### Battery Handling Precautions

- **Keep the battery terminals clean at all times.**  
Dirty terminals may cause poor contact between the battery and camera. Polish the terminals with a soft cotton swab before charging or using the battery.
- **At low temperatures, battery performance may be reduced and the low battery icon (🔋) may appear earlier than usual.**  
Under these conditions, revive the battery by warming it in a pocket immediately before use.
- **However, ensure that there are no metallic items in the pocket that could cause a short circuit, such as a key ring, etc.**  
The battery may be short circuiting.

- **Do not allow any metal objects such as key rings to touch the (+) and (-) terminals (Fig. A). To carry the battery or store it during periods of disuse, always replace the terminal cover (Fig. B).**  
These conditions can damage the battery.

Fig. A



Fig. B

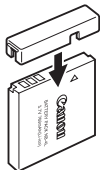

You may be able to check the charge state depending upon how the terminal cover is attached (Fig. C, D).

Fig. C



**Charged Battery**  
Attach it so the ▲  
is visible.

Fig. D



**Spent Battery**  
Attach it the  
opposite way to  
Fig. C.

- **You are recommended to use it in the camera until it is completely discharged and to store it in an indoor location with low relative humidity and between the temperatures of 0 – 30 °C (32 – 86 °F).**

Storing a fully charged battery for long periods of time (about one year) may shorten its life cycle or affect its performance. If you do not use the battery for long periods of time, charge it fully and discharge it fully in the camera about once a year before returning it to storage.

## Charging the Battery

- **Since this is a lithium-ion battery, you need not completely discharge it before recharging.**
- **It takes approximately 90 minutes to fully charge the battery from a fully discharged state (based on Canon's testing standards).**
  - Charging it within a temperature range of 5 – 40 °C (41 – 104 °F) is recommended.
  - Charge times may vary according to the ambient temperature and the battery's charge state.
- **You are advised to charge the battery on the day of use, or one day before, to ensure a full charge.**

Even charged batteries continue to discharge naturally.
- **If the performance of the battery diminishes substantially even when it is fully charged, its life has been exceeded and it should be replaced.**

# Handling the Memory Card

## Write Protect Tab

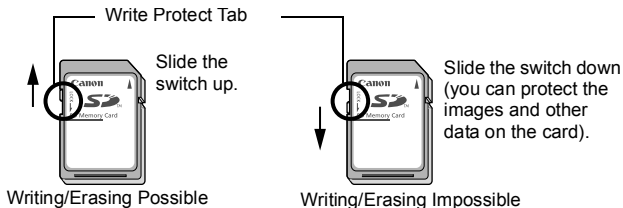

## Cautions When Handling

- Memory cards are high-precision electronic devices. Do not bend them, apply force to them, or subject them to shocks or vibration.
- Do not attempt to disassemble or alter the memory card.
- Do not allow dirt, water or foreign objects to contact the terminals on the back of the card. Do not touch the terminals with your hands or metal objects.
- Do not peel away the original label on the memory card or cover it with another label or sticker.
- When writing on the memory card, do not use a pencil or ball-point pen. Only use a soft point pen (e.g. felt-tip pen).
- Do not use or store memory cards in the following locations.
  - Locations subject to dust or sand
  - Locations subject to high humidity and high temperatures
- Since some or all of the data recorded on the memory card may be corrupted or erased by electrical noise, static electricity, or camera or card malfunction, making a backup copy of important data is recommended.

## Formatting

- **Please note that formatting (initializing) an memory card erases all data, including protected images.**
- **You are recommended to use memory cards that have been formatted in your camera.**
  - The card supplied with the camera may be used without further formatting.
  - When the camera is malfunctioning, a corrupted memory card might be the cause. Reformatting the memory card may solve the problem.
  - When a non-Canon brand memory card is malfunctioning, reformatting it may solve the problem.
  - Memory cards formatted in other cameras, computers, or peripheral devices may not operate correctly in this camera. When that happens, reformat the memory card with this camera.
- **If formatting in the camera does not work properly, turn the camera off and re-insert the memory card. Then turn the camera back on and format again.**

## Using an AC Adapter Kit (Sold Separately)

It is best to power the camera with AC Adapter Kit ACK-DC10 (sold separately) when you are using it for long periods of time or connecting it to a computer.



Turn the camera power off before connecting or disconnecting the compact power adapter.

- 1 Connect the power cord to the compact power adapter first and then plug the other end into the power outlet.**

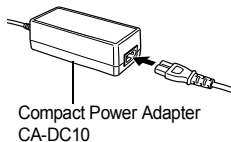

- 2 Open the memory card slot/battery cover, push the battery lock in the direction of the arrow, then insert the DC coupler until it is locked.**

- Slide the memory card slot/battery cover closed.

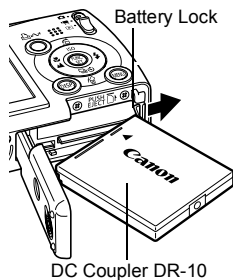

- 3 Slide the switch on the inside of the memory card slot/battery cover towards the inside, then open the DC coupler terminal cover.**



- 4** Close the memory card slot/battery cover and attach the cord to the DC terminal.

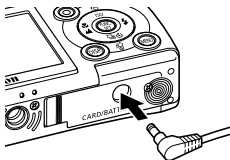

## Using an Externally Mounted Flash (Sold Separately)

### High-Power Flash HF-DC1

This flash is used to supplement the camera's built-in flash when the subject is too far away for proper illumination. Use the following procedures to affix the camera and High-Power Flash to the supporting bracket.

Please read the instructions accompanying the flash along with this explanation.

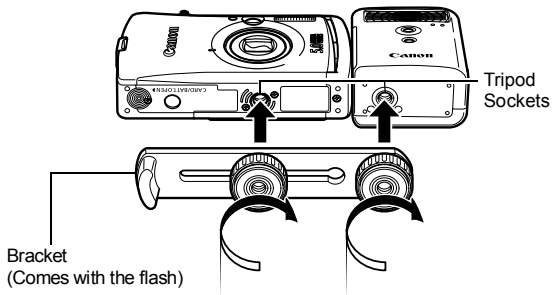



- The flash charge time will lengthen as the battery charge gets weaker. Always set the power/mode switch to [OFF] when you finish using the flash.
- Be careful not to touch the flash window or sensor windows with your fingers while the flash is in use.
- The flash may fire if another flash is being used in close proximity.
- The High-Power Flash may not fire outdoors in daylight or when there are no reflective items.
- For continuous shooting, although the flash fires for the first shot, it does not fire for subsequent shots.
- Fasten the attachment screws securely so that they do not loosen. Failure to do so may lead to the dropping of the camera and flash resulting in damage to both.



- Before attaching the bracket to the flash, check that the lithium battery (CR123A or DL123) is installed.
- To illuminate the subjects properly, install the flash so that it is up against the side of the camera and parallel with the camera's front panel.
- A tripod can be used even when the flash is attached.

## Batteries

### ● Charge becomes Severely Limited

If the battery usage time has considerably diminished, wipe the battery terminals well with a dry cloth. The terminals may be dirty from fingerprints.

### ● Usage in Cold Temperatures (Less than 0°C/32°F)

Get a spare generic lithium battery (CR123A or DL123). You are recommended to place the spare battery in your pocket to warm it up before switching it for the battery in the flash.

### ● Non-Use over Extended Periods

Leaving batteries in the High-Power Flash could allow the battery fluid to leak, damaging the product. Remove the batteries from the High-Power Flash and store them in a cool, dry place.

# Camera Care and Maintenance

Never use thinners, benzine, synthetic cleansers or water to clean the camera. These substances may distort or damage the equipment.

## Camera Body

Gently wipe dirt off the camera body with a soft cloth or eyeglass lens wiper.

## Lens

First use a lens blower brush to remove dust and dirt, then remove any remaining dirt by wiping the lens lightly with a soft cloth.



Never use synthetic cleansers on the camera body or lens. If dirt remains, contact the closest Canon Customer Support Help Desk as listed on rear of this booklet or the European Warranty System (EWS) Booklet.

## Viewfinder and LCD Monitor

Use a lens blower brush to remove dust and dirt. If necessary, gently wipe with a soft cloth or an eyeglass lens wiper to remove stubborn dirt.



Never rub or press strongly on the LCD monitor. These actions may damage it or lead to other problems.

# Specifications

All data is based on Canon's standard testing methods. Subject to change without notice.

## DIGITAL IXUS WIRELESS

(W): Max. wide angle (T): Max. telephoto

<b>Camera Effective Pixels</b>	Approx. 5.0 million
<b>Image Sensor</b>	1/2.5-inch CCD (Total number of pixels: Approx. 5.3 million)
<b>Lens</b>	5.8 (W) – 17.4 (T) mm (35mm film equivalent: 35 (W) – 105 (T) mm) f/2.8 (W) – f/4.9 (T)
<b>Digital Zoom</b>	Approx. 4.0x (Up to approx. 12x in combination with the optical zoom)
<b>Optical Viewfinder</b>	Real-image zoom viewfinder
<b>LCD Monitor</b>	2.0-inch, low-temperature polycrystalline silicon TFT color LCD, approx. 118,000 pixels (Picture coverage 100%)
<b>AF System</b>	TTL autofocus Focusing frame: 9-point AiAF/1-point AF (fixed to center)
<b>Shooting Distance (From the front of the lens)</b>	Normal: 30 cm (1.0 ft.) – infinity Macro: 3 – 50 cm (W)/30 – 50 cm (T) (1.2 in. – 1.6 ft. (W)/1.0 – 1.6 ft. (T)) Infinity: 3 m (9.8 ft.) – infinity
<b>Shutter</b>	Mechanical shutter + electronic shutter
<b>Shutter Speeds</b>	15 – 1/1500 sec. <ul style="list-style-type: none"><li>• The shutter speed varies according to the shooting mode.</li><li>• Slow shutter speeds of 1.3 sec. or slower operate with noise reduction.</li></ul>
<b>Metering System</b>	Evaluative, Center-weighted average or Spot (fixed to center)
<b>Exposure Compensation</b>	± 2 stops in 1/3-stop increments
<b>ISO Speed</b>	Auto*, ISO 50/100/200/400 equivalent * Camera automatically sets the optimal speed.
<b>White Balance</b>	Auto, pre-set (available settings: Daylight, Cloudy, Tungsten, Fluorescent or Fluorescent H) or custom

<b>Built-in Flash</b>	Auto, auto with red-eye reduction, flash on with red-eye reduction, flash on, flash off, slow synchro
<b>Flash Range</b>	Normal: 50 cm – 3.5 m (1.6 – 12 ft.) (W), 50 cm – 2.0 m (1.6 – 6.6 ft.) (T) Macro: 30 – 50 cm (1.0 – 1.6 ft.) (W/T) (When ISO speed is set to AUTO.)
<b>Shooting Modes (Still images)</b>	Auto, Manual <sup>1</sup> , Digital macro, Portrait, Night Snapshot, My Colors, Scene Mode <sup>2</sup> , Stitch assist <sup>3</sup> 1 Long shutter mode available 2 Kids&Pets, Indoor, Foliage, Snow, Beach, Fireworks 3 Selectable in Manual mode.
<b>(Movies)</b>	Standard, Fast Frame Rate, Compact, My Colors
<b>Continuous Shooting</b>	Approx. 2.1 shots/sec. (Large/Fine mode)
<b>Self-timer</b>	Activates shutter after an approx. 10-sec./ approx. 2-sec. delay, Custom Timer
<b>PC-controlled Shooting</b>	Available (Wireless connection only. Exclusive software program is included in the camera kit.)
<b>Recording Media</b>	SD memory card/MultiMediaCard • This camera has been tested with memory cards through 2GB. All memory card functions cannot be guaranteed.
<b>File Format</b>	Design rule for camera file system and DPOF compliant
<b>Data Type (Still images)</b>	Exif 2.2 (JPEG) <sup>*1</sup>
<b>(Movies)</b>	AVI (Image data: Motion JPEG; Audio data: WAVE (monaural))
<b>Compression</b>	Superfine, Fine, Normal
<b>Number of Recording Pixels (Still Images)</b>	Large: 2592 × 1944 pixels Medium 1: 2048 × 1536 pixels Medium 2: 1600 × 1200 pixels Small: 640 × 480 pixels Postcard Date Imprint Mode: 1600 × 1200 pixels
<b>(Movies)</b>	Standard, My Colors: 640 × 480 pixels (30 frames/sec., 15 frames/sec.) 320 × 240 pixels (30 frames/sec., 15 frames/sec.) Recording can continue until the memory card is full* (can record up to a maximum of 1 GB at one time).

<b>Number of Recording Pixels (Movies)</b>	Fast Frame Rate: (can record for 1 min.) 320 × 240 pixels (60 frames/sec.) Compact: (can record for 3 min.) 160 × 120 pixels (15 frames/sec.) * Using super high-speed memory cards (SDC-512MSH recommended).
<b>Playback Modes</b>	Single (histogram displayable), Index (9 thumbnail images), Magnified (approx. 10x (max.) on the LCD monitor, advance or reverse through magnified images possible), Jump (jumps to every tenth or hundredth image, to the first image of those sharing a certain shooting date, to movies, or to the first image in a folder. In index playback mode, it displays 9 images at once.), Sound memos (up to 60 sec.), Slide show or Movie (edit/slow motion play back possible).
<b>Direct Print</b>	<i>PictBridge</i> compliant, and <i>Canon Direct Print</i> and <i>Bubble Jet Direct</i> compatible
<b>My Camera Settings</b>	Start-up image, start-up sound, operation sound, self-timer sound, and shutter sound.
<b>Wireless Standard</b>	IEEE802.11b
<b>Wireless Channel</b>	Channel 1 - 11 (PowerShot SD430 DIGITAL ELPH WIRELESS) Channel 1 - 13 (DIGITAL IXUS WIRELESS)
<b>Security</b>	Infrastructure: WEP64/128 bit, WPA-PSK (TKIP/AES) Ad hoc: WEP64/128 bit (when connecting to computer) AES (when connecting to WA-1)
<b>Transmission range</b>	Approx. 30 m (98.4 ft.) (However, make sure that there are no interfering obstacles between the devices.) • The distance will vary with the installation site, the environment of use, and the conditions of use.
<b>Interface</b>	USB 2.0 Hi-Speed (mini-B), PTP (Picture Transfer Protocol) Audio/Video output (NTSC or PAL selectable, monaural audio)
<b>Power Source</b>	Battery Pack NB-4L (Lithium-ion Rechargeable battery) AC Adapter Kit ACK-DC10
<b>Operating Temperature</b>	0 – 40 °C (32 – 104 °F)

<b>Operating Humidity</b>	10 – 90%
<b>Dimensions</b>	99.0 × 54.4 × 21.7 mm (3.90 × 2.14 × 0.85 in.) (excluding protrusions)
<b>Weight</b>	Approx. 130 g (4.59 oz.) (camera body only)

\*1 This digital camera supports Exif 2.2 (also called “Exif Print”). Exif Print is a standard for enhancing the communication between digital cameras and printers. By connecting to an Exif Print-compliant printer, the camera’s image data at the time of shooting is used and optimized, yielding extremely high quality prints.

## Battery Capacity (Battery Pack NB-4L (Fully charged))

Number of Images Shot		Playback Time
LCD Monitor ON (Based on the CIPA standard)	LCD Monitor Off	
Approx. 150 images	Approx. 500 images	Approx. 3 hours

- The actual figures will vary according to the shooting conditions and settings.
- When shooting movies or using the auto transfer function, the battery capacity will vary from that shown above.
- At low temperatures, the battery performance may diminish and the low battery icon may appear very rapidly. In these circumstances, the performance can be improved by warming the battery in a pocket before use.

## Test Conditions

Shooting: Normal temperature (23 °C ± 2 °C/73 °F ± 3.6 °F), normal relative humidity (50% ± 20%), alternating wide angle end and telephoto end shots at 30 second intervals with the flash fired once every two shots and the camera power turned off after every tenth shot. Power is left off for a sufficient amount of time\*, then the power is turned back on and the testing procedure is repeated.

● A Canon-brand memory card is used.

\*Until the battery returns to normal temperature















Playback: Normal temperature (23 °C ± 2 °C/73 °F ± 3.6 °F), normal relative humidity (50% ± 20%), continuous playback at 3 seconds per image.



See *Battery Handling Precautions* (p. 119).















# Memory Cards and Estimated Capacities



: Card included with the camera

Recording Pixels	Compression	SDC-16M	SDC-128M	SDC-512MSH
<b>L</b> (Large) 2592 × 1944 pixels		5	49	190*
		9	87	339
		19	173	671
<b>M1</b> (Middle 1) 2048 × 1536 pixels		8	76	295
		15	136	529
		30	269	1041
<b>M2</b> (Middle 2) 1600 × 1200 pixels		13	121	471
		24	217*	839
		46	411	1590
<b>S</b> (Small) 640 × 480 pixels		52	460	1777
		80	711	2747
		127	1118	4317
 (PostCard Date Imprint Mode) 1600 × 1200 pixels		24	217*	839





-  Capable of smooth continuous shooting (p. 43) (\*Only available when card has been formatted with a low level format).
- This reflects standard shooting criteria established by Canon. Actual results may vary according to the subject and shooting conditions.

## Movie















	Recording Pixels	Frame Rate	SDC-16M	SDC-128M	SDC-512MSH
 Standard	 640 × 480 pixels		6 sec.	1 min. 4 sec.	4 min. 9 sec.
			14 sec.	2 min. 7 sec.	8 min. 14 sec.
 My Colors	 320 × 240 pixels		20 sec.	3 min. 1 sec.	11 min. 42 sec.
			40 sec.	5 min. 55 sec.	22 min. 53 sec.
 Fast Frame Rate	 320 × 240 pixels		10 sec.	1 min. 32 sec.	5 min. 59 sec.
 Compact	 160 × 120 pixels		1 min. 39 sec.	14 min. 29 sec.	55 min. 57 sec.

- Maximum movie clip length at : 1 min., at : 3 min. The figures indicate the maximum continuous recording time.

## Image Data Sizes (Estimated)

Recording Pixels	Compression		
			
<b>L</b> (2592 × 1944 pixels)	2503 KB	1395 KB	695 KB
<b>M1</b> (2048 × 1536 pixels)	1602 KB	893 KB	445 KB
<b>M2</b> (1600 × 1200 pixels)	1002 KB	558 KB	278 KB
<b>S</b> (640 × 480 pixels)	249 KB	150 KB	84 KB
 (1600 × 1200 pixels)	–	558 KB	–

## Movie

	Recording Pixels	Frame Rate	File size
 Standard	 (640 × 480 pixels)		1980 KB/sec.
			990 KB/sec.
 My Colors	 (320 × 240 pixels)		660 KB/sec.
			330 KB/sec.
 Fast Frame Rate	 (320 × 240 pixels)		1320 KB/sec.
 Compact	 (160 × 120 pixels)		120 KB/sec.

## Wireless Print Adapter WA-1

<b>Supported Camera</b>	DIGITAL IXUS WIRELESS
<b>Supported Printer</b>	Canon <i>PictBridge</i> compliant printer* * Compact power adapter CA-DC20/CA-DC20E is required (except for SELPHY CP710/CP510). SELPHY CP710/CP510 can be powered by the USB bus.
<b>Wireless Standard</b>	IEEE802.11b
<b>Wireless Mode</b>	Ad hoc Mode
<b>Security</b>	AES
<b>Transmission range</b>	Approx. 30 m (However, make sure that there are no interfering obstacles between the devices.)
<b>Interface</b>	USB
<b>Display</b>	Blue LED, Orange LED
<b>Power Source</b>	DC 5.0 V (when powered by USB bus) DC 5.0 V (when using CA-DC20/CA-DC20E)
<b>Dimensions</b>	92.5 × 27.0 × 28.8 mm (3.64 × 1.06 × 1.13 in.) (When folded)
<b>Weight</b>	Approx. 40 g (1.4 oz.)

## Compact Power Adapter CA-DC20/CA-DC20E

<b>Rated Input</b>	100 - 240 V AC (50/60 Hz) 11 VA (100 V) - 13 VA (240 V) (CA-DC20) 100 mA (CA-DC20E)
<b>Rated Output</b>	5.0 V DC, 0.7 A
<b>Operating Temperatures</b>	0 - 40 °C (32 - 104 °F)
<b>Dimensions</b>	49.4 × 53.4 × 20.5 mm (1.94 × 2.10 × 0.81 in.) (CA-DC20) 28.0 × 78.0 × 21.0 mm (1.10 × 3.07 × 0.83 in.) (CA-DC20E)
<b>Weight</b>	Approx. 92 g (3.25 oz.) (CA-DC20) Approx. 75 g (2.65 oz.) (excluding power cord) (CA-DC20E)

## SD Memory Card

Interface	Compatible with SD memory card standards
Dimensions	32.0 × 24.0 × 2.1 mm (1.26 × 0.94 × 0.08 in.)
Weight	Approx. 2 g (0.07 oz.)

## Battery Pack NB-4L

Type	Lithium-ion Rechargeable battery
Nominal Voltage	3.7 V DC
Typical Capacity	760 mAh
Operating Temperatures	0 – 40 °C (32 – 104 °F)
Dimensions	35.4 × 40.3 × 5.9 mm (1.40 × 1.59 × 0.23 in.)
Weight	Approx. 17 g (0.60 oz.)

## Battery Charger CB-2LV/CB-2LVE

Rated Input	100 – 240 V AC (50/60 Hz) 10 VA (100 V) – 14 VA (240 V) (CB-2LV) 0.1 A (100 V) – 0.06 A (240 V) (CB-2LVE)
Rated Output	4.2 V DC, 0.65 A
Charging Time	Approx. 90 minutes
Operating Temperatures	0 – 40 °C (32 – 104 °F)
Dimensions	53.0 × 86.0 × 19.5 mm (2.1 × 3.4 × 0.77 in.)
Weight	Approx. 60 g (2.1 oz.) (CB-2LV) Approx. 55 g (1.9 oz.) (CB-2LVE) (excluding power cable)

## Compact Power Adapter CA-DC10

(Included with the separately sold AC Adapter Kit ACK-DC10)

Rated Input	100 – 240 V AC (50/ 60 Hz) 16 VA (100 V) – 26 VA (240 V)
Rated Output	4.3 V DC, 1.5 A
Operating Temperatures	0 – 40 °C (32 – 104 °F)
Dimensions	42.6 × 104.4 × 31.4 mm (1.7 × 4.1 × 1.2 in.)
Weight	Approx. 180 g (6.3 oz.)

# INDEX

## A

- AC Adapter Kit ACK-DC10... 123
- AE Lock ..... 53
- AF Frame ..... 51, 52
- AF Lock ..... 52
- AF-assist Beam ..... 33
- AiAF ..... 33
- Auto Play (Slide Shows)..... 83
- Auto Rotate Function..... 70
- AV cable ..... 93

## B

- Battery
  - Battery Capacity ..... 130
  - Charging.. 119, *Basic Guide 1*
  - Handling ..... 119
  - Installing ..... *Basic Guide 2*

## C

- Clock Display..... 20
- Compression ..... 39
- Continuous Shooting ..... 43
- Create Folder ..... 71
- Custom White Balance ..... 60

## D

- Date/Time
  - Setting ..... *Basic Guide 4*
  - Using the Clock ..... 20
  - World Clock ..... 29
- Digital Macro ..... 41
- DIGITAL Terminal ..... 15
- Digital Zoom ..... 42
- Downloading Images to a Computer..... 16
- DPOF Print Order
  - Print Style ..... 90
  - Selecting Images..... 89
- DPOF Transfer Order..... 91

## E

- Erasing
  - All Images..... 87
  - Single Images..... 17, *Basic Guide 11*
- Exposure ..... 56

- Exposure Shift ..... 49

## F

- FE Lock..... 54
- File Number ..... 72
- Flash ..... 15, *Basic Guide 9*
- Focus ..... 51
- Focus Lock ..... 52
- Frame Rates ..... 40
- FUNC. Menu ..... 31
- FUNC./SET Button..... 17

## G

- Grid Lines ..... 33

## H

- HF-DC1..... 124
- Histogram ..... 25

## I

- Image Data Sizes (Estimated) ..... 132
- Index Playback ..... 75
- Indicators ..... 26
- Infinity ..... 17, *Basic Guide 10*
- Interface Cable .. *Basic Guide 16*
- ISO Speed ..... 69

## J

- Jump (Image Search) ..... 76

## L

- Language ..... *Basic Guide 4*
- LCD Monitor
  - Information Displayed ..... 22
  - Night Display..... 21
  - Playback Information ..... 23
  - Quick-bright LCD ..... 21
  - Shooting Information..... 22
  - Using the LCD Monitor ..... 19

## M

- Macro ..... 17, *Basic Guide 10*
- Magnifying ..... 74
- Memory Card
  - Formatting..... 122
  - Handling..... 121
  - Inserting ..... *Basic Guide 2*

Memory Cards	
Estimated Capacities .....	131
Formatting.....	28
Menu	
FUNC. Menu .....	31, 33
Menu List .....	33
Menus and Settings .....	31
My Camera Menu .....	36
Play Menu .....	34
Rec. Menu .....	33
Set up Menu .....	34
Wireless Menu .....	34
MENU Button .....	17
Messages .....	115
Metering Modes .....	55
Mode Switch .....	17,
..... <i>Basic Guide 4, Basic Guide 5</i>	
Movie	
Editing .....	78
Playback .....	77
Shooting.....	47
Mute Mode .....	34, <i>Basic Guide 5</i>
My Camera Menu .....	36
My Camera Settings .....	94
My Colors.....	63
<b>O</b>	
Output .....	93
<b>P</b>	
Photo Effect .....	62
Playback .....	<i>Basic Guide 11</i>
Postcard Date Imprint Mode ..	44
Power Button .	17, <i>Basic Guide 5</i>
Power Saving.....	27, 35
Print/Share Button .....	17,
..... <i>Basic Guide 14</i>	
Printing .....	<i>Basic Guide 14</i>
Protect .....	87
<b>R</b>	
Recording Pixels .....	38, 40
Red-Eye Reduction.....	15,
..... <i>Basic Guide 9</i>	
Reset All .....	37
Rotate .....	80
<b>S</b>	
Self-Timer .....	45
Set up Menu .....	34
Shooting Mode	
Auto .....	<i>Basic Guide 7</i>
Digital Macro .....	41
Manual .....	<i>Basic Guide 7</i>
Movie.....	47, <i>Basic Guide 8</i>
Scene Mode ....	<i>Basic Guide 7</i>
Beach .....	<i>Basic Guide 8</i>
Fireworks .....	<i>Basic Guide 8</i>
Foliage .....	<i>Basic Guide 7</i>
Indoor .....	<i>Basic Guide 7</i>
Kids&Pets ....	<i>Basic Guide 7</i>
Snow .....	<i>Basic Guide 7</i>
Selecting .....	<i>Basic Guide 6</i>
Stitch Assist.....	49
Shutter Button .....	17
Fully .....	<i>Basic Guide 6</i>
Halfway .....	<i>Basic Guide 5</i>
Shutter Speed .....	57
Slide Shows.....	83
Repeat Settings.....	86
Selecting .....	85
Transition .....	84
Smooth Continuous Shooting.	43
Sound Memo.....	81
Spot AE Point Frame.....	55
Spot Frame.....	22
<b>T</b>	
Telephoto .....	<i>Basic Guide 8</i>
Time Zone .....	30, 35
Transition Effects	
Playback.....	81
Slide Show .....	84
<b>V</b>	
Video Output System .....	93
<b>W</b>	
White Balance .....	59
Wide Angle.....	8
Wireless	
Connecting to Printer .....	98
Connecting/Disconnecting ..	100
Target Device.....	102, 104
Wireless Print	
Adapter.....	18, 26, 98, 102
Wrist Strap.....	16
<b>Z</b>	
Zoom .....	<i>Basic Guide 8</i>

## Disclaimer









































- While every effort has been made to ensure that the information contained in this guide is accurate and complete, no liability can be accepted for any errors or omissions.
- Canon reserves the right to change the specifications of the hardware and software described herein at anytime without prior notice.
- No part of this guide may be reproduced, transmitted, transcribed, stored in a retrieval system, or translated into any language in any form, by any means, without the prior written permission of Canon.
- Canon makes no warranties for damages resulting from corrupted or lost data due to a mistaken operation or malfunction of the camera, the software, SD memory cards (SD cards), personal computers, peripheral devices, or use of non-Canon SD cards.











## Trademark Acknowledgments

- Canon, PIXMA and SELPHY are trademarks of Canon Inc.
- Macintosh, Mac OS and QuickTime are trademarks of Apple Computer Inc., registered in the United States and/or other countries.
- Microsoft® and Windows® are either registered trademarks or trademarks of Microsoft Corporation in the United States and/or other countries.
- SD is a trademark.
- Wi-Fi® is a registered trademark of the Wi-Fi Alliance; and Wi-Fi CERTIFIED™ and WPA™ are trademarks of the Wi-Fi Alliance.
- All other product and service names mentioned herein are the marks of their respective owners.
- Other names and products not mentioned above may be registered trademarks or trademarks of their respective companies.

# Functions Available in Each Shooting Mode

The chart below is a reference for the settings available for various shooting conditions. The settings selected in each shooting mode are saved after you finish shooting.

Function									 Page	
						  	  	  		
Recording Pixels	Large		○*	○*	○*	○*	○*	△*	—	p. 38 p. 40
	Medium 1		○	○	○	○	○	△	—	
	Medium 2		○	○	○	○	○	△	—	
	Small		○	○	○	○	○	△	—	
	Postcard		○	○	—	○	○	—	—	
	Movie		—	—	—	—	—	—	○ <sup>(1)</sup>	
Compression	Super Fine		○	○	○	○	○	△	—	p. 39
	Fine		○*	○*	○*	○*	○*	△*	—	
	Normal		○	○	○	○	○	△	—	
Frame Rate			—	—	—	—	—	—	○ <sup>(2)</sup>	p. 40
Flash <sup>(3)</sup>	Auto		○	○	—	○	○	—	—	Basic Guide p. 9
	Auto with Red-Eye Reduction		○*	○*	—	○*	○	—	—	
	On with Red-Eye Reduction		—	—	—	—	○	—	—	
	On		—	○	—	○	○	△	—	
	Off		○	○	○*	○ <sup>(4)</sup>	○	△*	—	
	Slow Synchro		—	○	—	○	—	△	—	
Macro Mode			○	○	—	○	○ <sup>(5)</sup>	△	○	Basic Guide p. 10
Infinity Mode			—	○	—	○	○ <sup>(5)</sup>	△	○	
AF Lock			—	○	○	○	—	—	○	p. 52
AE Lock			—	○	○	○	—	—	○	p. 53
FE Lock			—	○	—	○	—	—	—	p. 54
Shooting Method	Single		○*	○*	○*	○*	○*	△*	○*	—
	Continuous Shooting		—	○	○	—	○	—	—	p. 43
	10-sec. Self-Timer		○	○	○	○	○	△	○	p. 45
	2-sec. Self-Timer		○	○	○	○	○	△	○	
	Custom Timer		○	○	○	—	○	—	—	
Date Stamp			○	○	—	○	○	—	—	p. 44
Autofocus Modes			—	○	○	○	○ <sup>(6)</sup>	—	—	p. 51
AF-assist Beam			○	○	○	○	○ <sup>(7)</sup>	△	○	p. 33











Function									Page
						   			
Digital Zoom	On	○	○	○	—	○	—	○ <sup>(8)</sup>	p. 42
	Off	○*	○*	—	○	○*	○	○	
Metering Method	Evaluative	— <sup>(10)</sup>	○*	○*	○*	— <sup>(10)</sup>	—	— <sup>(10)</sup>	p. 55
	Center-Weighted Average	—	○	○	○	—	—	—	
	Spot	—	○	○	○	—	—	—	
Exposure Compensation		—	○	○	○ <sup>(9)</sup>	○	△	—	p. 56
Exposure Shift		—	—	—	—	—	—	○	p. 49
Long Shutter		—	○	—	—	—	—	—	p. 57
White Balance		—	○	○	○	— <sup>(10)</sup>	△	○	p. 59
Photo Effect		—	○	○	—	— <sup>(10)</sup>	△	○ <sup>(11)</sup>	p. 62
ISO Speed		— <sup>(10)</sup>	○	○	— <sup>(10)</sup>	— <sup>(10)</sup>	— <sup>(10)</sup>	— <sup>(10)</sup>	p. 69
Auto Rotate		○	○	○	○	○	△	—	p. 70
Grid Lines		○	○	○	○	○	—	○	p. 33









\*Default setting ○Setting available △ Setting can only be selected for the first image.













 (Shaded Area): Setting is retained even when the camera power is shut off.

With the exception of the [Time Zone], [Date/Time], [Language] and [Video System] settings, all the other menu settings and changes made with the camera buttons can be reset to the default values in a single operation (p. 37).

(1)(2) The recording pixels and frame rates for the  (Movie) mode are as follows.

	Recording Pixels			Frame Rate		
						
 	○*	○	—	—	○*	○
	—	○	—	○	—	—
	—	—	○	—	—	○

(3) The default flash setting is Auto with Red-Eye Reduction in the     modes, Auto in the   modes, and Off in the   modes.

- The flash cannot be set in  mode.
  - When the flash fires in  mode, the camera will automatically use Slow Synchro mode.
- (4) The flash is set by default not to fire in the  and  modes.
- (5) You cannot switch between the Macro/Infinity modes when the camera is in the   modes.
- (6) AF cannot be selected in the   modes.
- (7) The AF-assist Beam cannot be set in  mode.
- (8) Can even be set during shooting (Standard only).
- (9) Exposure compensation not available in  or  modes.
- (10) Automatically set by the camera.
- (11) The Photo Effect cannot be set in the  mode.



**Canon**