

# DENON<sup>®</sup>

## AH-GC20

GLOBE CRUISER™ Over-ear Headphones/  
Wireless Noise-Cancelling Headphones

# Owner's Manual

You can print more than one page of a PDF onto a single sheet of paper.



## Preparation

<b>Unpacking</b>	<b>4</b>
<b>Features</b>	<b>5</b>
Sound quality	5
Functions	5
Telephone Calls	5
<b>Features and functions</b>	<b>6</b>
<b>Charging</b>	<b>7</b>
<b>Using Audio Guidance (Notification Sounds)</b>	<b>9</b>

## Connections

<b>Bluetooth operation</b>	<b>11</b>
Pairing	11
Registering (Pairing) and connecting a Bluetooth device	11
Reconnecting paired devices	13
Deleting pairing information	14
Turning the power on	15
Turning the power off	15
Wearing the headphones	16
Simultaneously connecting multiple Bluetooth devices (Multipoint function)	17

## Operation

<b>Listening to music</b>	<b>19</b>
Listening to music using a Bluetooth connection	19
Listening to music using a wired connection	20
Decreasing outside noise (Noise cancell function)	21
<b>Conducting phone calls</b>	<b>22</b>
Making a call	22
Answering an incoming call	22
Ending a call	22
Using the call waiting function	23
Ignoring an incoming call	23
Switching a call from the headphones to a mobile phone	23
Other operations	24
<b>Information</b>	<b>25</b>
Airplane use	25
Storage in the carrying case	25



## Troubleshooting

---

Troubleshooting	26
-----------------	----

## Appendix

---







Precautions for Use	28
Disposal of these headphones	29
Trademark information	29
Specifications	30

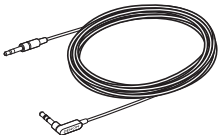
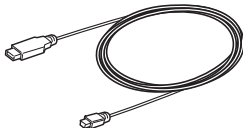
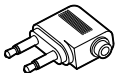
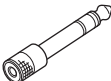

Thank you for purchasing this product. To ensure proper operation, please read this Owner's Manual carefully before using the product.

## Unpacking

Unpack your new AH-GC20 and verify that the following items are included.

 <p>Quick Guide</p>	 <p>Precautions on the use of headphones</p>	 <p>Audio cable (approx. 1.3 m)</p>	 <p>USB cable (for charging: Approx. 0.5 m)</p>
 <p>Conversion plug for aircraft use</p>	 <p>6.3 mm Conversion adapter</p>	 <p>Carrying case</p>	 <p>Notes on radio</p>
 <p>Accessory pouch</p>			



## Features

### Sound quality

- These headphones are compatible with a wide range of codecs, including the high sound quality aptX, AAC and SBC. These headphones automatically select the optimum compatible codec for your Bluetooth device (smartphone or tablet) so you can enjoy high-grade wireless sound. Additionally, aptX is Low Latency compatible so you can enjoy videos and gaming without audio lag.

### Functions

- You can enjoy listening to music wirelessly by connecting these headphones to your Bluetooth device. Playback operations and volume adjustment can be performed for the paired audio device using the headphones.
- When the noise cancelling function is turned on, you can hear clear audio sound even if you are in a noisy location such as inside a train.
- You can connect to an audio device that is not equipped with Bluetooth using the supplied cable, or in case Bluetooth is not allowed or the battery runs out.

### Telephone Calls

- You can also make hands-free phone calls by pairing these headphones to a Bluetooth compatible mobile phone. Equipped with CVC (Clear Voice Capture) technology which suppresses echoes enabling low-noise phone calls.



## Features and functions

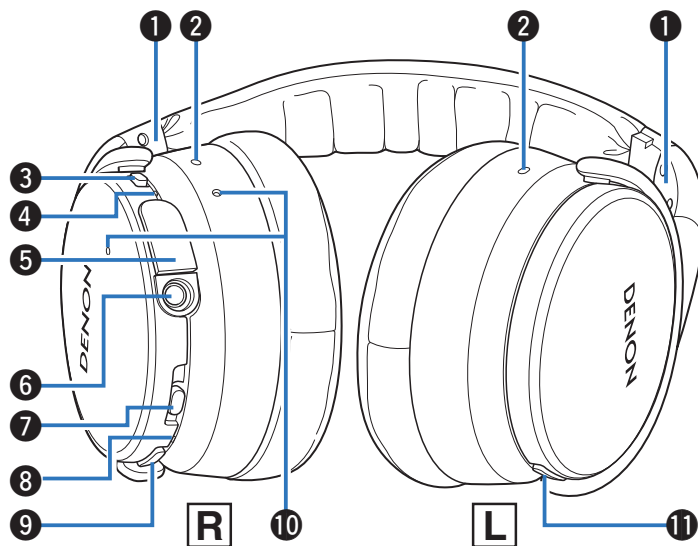

### 1 L/R Indicator

### 2 Noise cancelling microphone

### 3 Noise cancelling function toggle switch

Turns the noise cancelling function on/off.

### 4 Charge/NC (Noise Cancell) indicator

- Blinks red according to the charging status. (☞ p. 7)
- Lights white when the noise cancelling function is on. (☞ p. 21)

### 5 Charging port

Connect the supplied USB cable to charge the headphones.

### 6 Stereo mini jack (3.5 mm)

Connection socket for the supplied audio cable.

### 7 Control button

- Turns the power on/off and pairs the headphones with Bluetooth devices. (☞ p. 11)
- Operates the audio device that is connected using Bluetooth. (☞ p. 19)

### 8 Bluetooth Indicator

Indicates the connection status with the Bluetooth device.

### 9 Volume button (+/-)

Adjusts the volume up and down. (☞ p. 19)

### 10 Call microphone

### 11 Call button

Controls call operations on the paired mobile phone. (☞ p. 22)



# Charging

When using the headphones for the first time after purchase or when the remaining battery is low, connect the headphones to a computer or a USB to AC power adapter (not included) using the supplied USB cable.

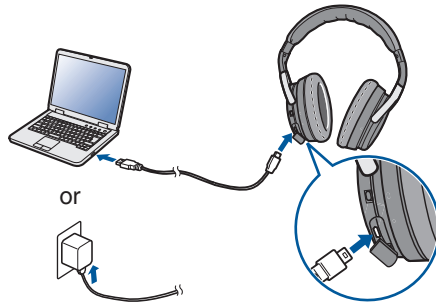

The Charge/NC indicator blinks during charging. It takes approximately 3 hours to charge the headphones. (The duration time differs depending on the charging output.)

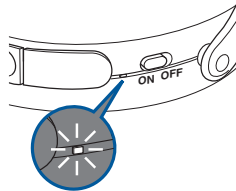

100 % charged : Lights red  
 50 - 99 % charged : Blinks red at 2-second intervals  
 0 - 49 % charged : Blinks red slowly



- You can connect the headphones to a device using the supplied audio cable to enjoy listening to music even if the batteries are drained. (☞ p. 20)
- The headphones can be used for approximately 20 hours of music playback when fully charged.
- You can listen to music from a paired Bluetooth device or make phone calls even during charging. In this case, noise may occur in the audio from the headphones depending on the type of computer used.

## NOTE

- When connecting the USB cable to the charging port, be sure to match the cable connector with the shape of the socket. Forcing the connector into the socket will cause damage.
- A rating of the charging output should be DC 5 V, 2.4 A or less.
- The usable time of the headphones differs depending on the temperature of the environment in which they are used and method of use.
- The power turns off when the USB cable is connected to the headphones during use. Turn on the power again to continue using the headphones.



## ■ Checking the remaining battery power

When the power is on (“Turning the power on” (☞ p. 15)), press the Call button twice to check the remaining battery power.

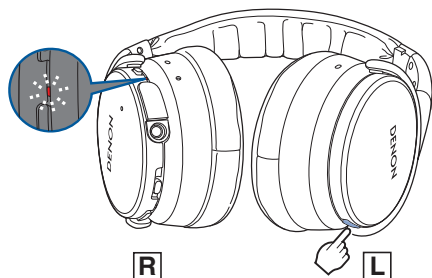

Remaining battery	Indicator	Beep sound
90 – 100 %	Blinks four times	Four times
60 – 89 %	Blinks three times	Three times
30 – 59 %	Blinks twice	Twice
10 – 29 %	Blinks once	Once

- The remaining battery power cannot be checked when a phone call is in progress.
- When the amount of remaining battery is running low, the indicator flashes red at three second intervals together with a beeping sound.
- If the battery runs out during use, a beeping sound is heard and the power of the headphones turns off.



## Using Audio Guidance (Notification Sounds)

You are notified when an operation has completed correctly by a “beep” or “audio guidance”. The default notification sound is a “beep”. You can switch the notification sound using the following procedure.

### ■ Switching to Audio Guidance Mode

- 1** End the audio playback or phone call on connected Bluetooth device, or turn off the Bluetooth function of the connected Bluetooth device.
- 2** Press and hold the call button and “+” volume button together for more than 5 seconds.
  - The beep sound is heard and the notification sound is switched to audio guidance.

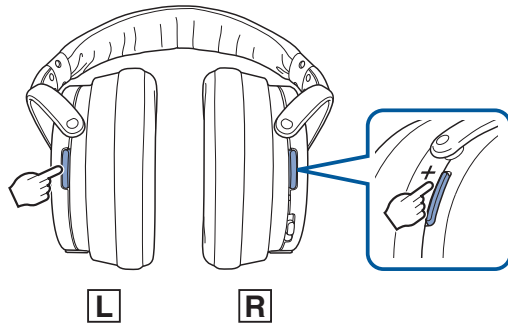

### ■ Switching to beep mode

- 1** End the audio playback or phone call on connected Bluetooth device, or turn off the Bluetooth function of the connected Bluetooth device.
- 2** Press and hold the call button and “-” volume button together for more than 5 seconds.
  - The beep sound is heard and the notification sound is switched to the beep sound.

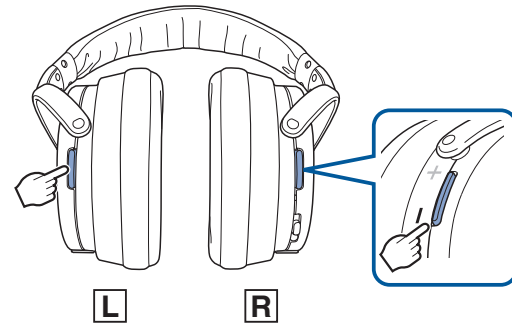

## ■ Switching the Audio Guidance Language

The audio guidance language can be selected from the following languages. (The default audio guidance language is “English”)  
English, Japanese, Chinese, German, French, Italian, Spanish

- 1 End the audio playback or phone call on connected Bluetooth device, or turn off the Bluetooth function of the connected Bluetooth device.**
- 2 Press and hold the call button and control button together.**
  - Audio in each language is played in order while the buttons are pressed down.
- 3 Release the buttons when the language that you want to select is played.**
  - A message informing you that the settings are complete is heard.

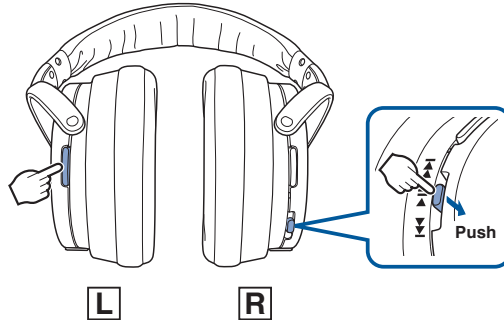

# Bluetooth operation

## Pairing

You need to register (pair) a Bluetooth device with the headphones in advance in order to enjoy listening to wireless music or make phone calls. You can connect to a Bluetooth device any time after it has been paired.

### NOTE

Pairing needs to be done again in the following cases.

- When 9 or more devices have been paired with the headphones

These headphones can store pairing information from a maximum of 8 devices.

When 9 or more devices are paired, the new pairing information overwrites the oldest pairing information in order from the oldest information onwards.

Multiple Bluetooth devices cannot be played back at the same time.

## Registering (Pairing) and connecting a Bluetooth device

### 1 Turning on Bluetooth on your mobile device



- For details, see the Owner's Manual of the Bluetooth device that you want to connect.



- 2** When the headphones power is off, press and hold the control button for approximately 4 seconds

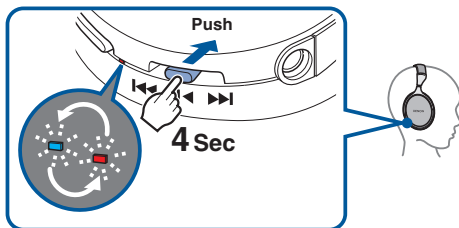

- The Bluetooth indicator flashes red and blue alternately indicating that the headphones are in pairing registration mode.

- 3** Select “DENON AH-GC20” from the list of devices displayed on the screen of your Bluetooth device

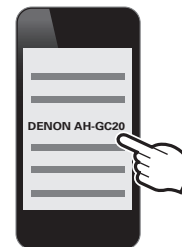

When the headphones are paired and connected to an audio device by Bluetooth, the Bluetooth indicator on the headphones lights blue for approximately 5 seconds to indicate that the Bluetooth connection is complete.



## 4 Playing back music on the Bluetooth device

Music played back on the connected Bluetooth device is output from the headphones.



- If the power is on, turn the power off before pairing.
- The headphones pairing registration mode is cancelled if pairing is not completed within 3 minutes. In this case, press and hold the control button for more than 5 seconds to turn the power off, and then try pairing again.
- If you are requested to enter a PIN code (pass key), enter "0000" (four zeros).

## Reconnecting paired devices

### 1 Turning on Bluetooth on your mobile device



- For details, see the Owner's Manual of the Bluetooth device that you want to connect.

### 2 Press and hold the control button for 1 second to turn the headphones power on

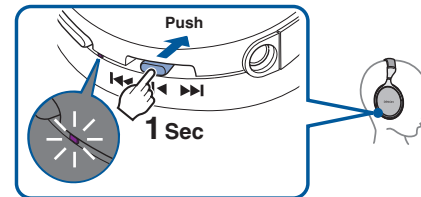

- A beep sound is heard and the Bluetooth indicator lights purple for approximately 1 second.
- The Bluetooth function turns on when the power is turned on.



### 3 The headphones automatically connect via Bluetooth to the Bluetooth device

If the device is not connected, select "DENON AH-GC20" from the list of devices displayed on the screen of your Bluetooth device.

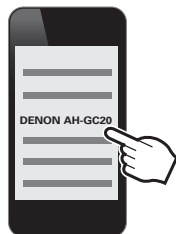

- The Bluetooth indicator on the headphones lights blue for approximately 5 seconds when the Bluetooth connection is complete.

### 4 Playing back music on the Bluetooth device

Music played back on the connected Bluetooth device is output from the headphones.

## Deleting pairing information

Delete pairing information if you have made a mistake entering pairing information or when re-pairing a device.

### 1 Press and hold the volume + button for more than 5 seconds when the headphones are in pairing registration mode with the Bluetooth device

- A beep sound is heard, the Bluetooth indicator flashes purple 5 times, and the pairing information is deleted.

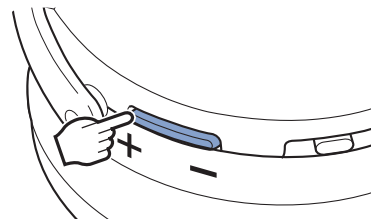

## Turning the power on

Turn on the Bluetooth function of the Bluetooth device that you want to connect to beforehand.

### 1 Press and hold the headphones control button for approximately 1 second

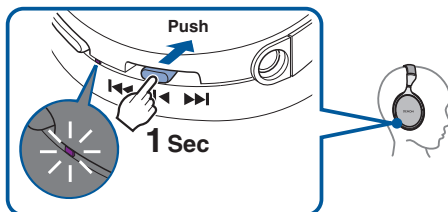

- When the pairing information is deleted, the headphones automatically switch to pairing registration mode when the power is turned on.
- A beep sound is heard and the Bluetooth indicator lights purple for approximately 1 second.
- The power turns on and Bluetooth function turns on.
- The headphones automatically connect via Bluetooth to the Bluetooth device when the device is already paired with the headphones. (👉 p. 13)

## Turning the power off

### 1 Press and hold the control button for more than 5 seconds

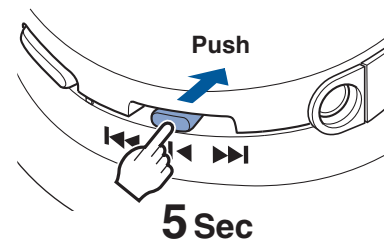

- A beep sound is heard and the Bluetooth indicator lights purple for approximately 1 second.



- If the audio cable is connected when the headphones power is on, the power automatically turns off.
- A small amount of power is consumed even when the power is off.
- If the indicator does not light even when the control button is pressed, the batteries are exhausted. Charge the batteries.



## Wearing the headphones

Adjust the slider to the preferred length.



### NOTE

- Be careful not to trap your fingers, etc. in the moving parts.
- Do not pull the slider too forcefully.
- In order to hear the best quality sound, be sure that the ear pads correctly cover both the left and right ears. If there are gaps between your ears and the headphone ear pads, sound will leak and the bass level and effectiveness of the noise cancelling function will be reduced.



## Simultaneously connecting multiple Bluetooth devices (Multipoint function)

Two Bluetooth devices can be simultaneously connected to the headphones, but of these only one device can be used to listen to music or make phone calls at any time. It is convenient to connect devices that you use frequently so that you do not need to re-connect each time you want to switch devices.

### ■ Connecting to a second Bluetooth device

- 1 Turn off the Bluetooth function of the paired (first) Bluetooth device (For details, see the Owner's Manual of the Bluetooth device that you connected.)**

- 2 Turn off the Bluetooth function of the headphones and then register (pair) the 2nd Bluetooth device**

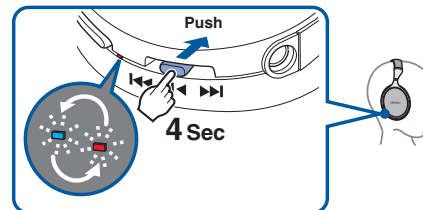

- See “Registering (Pairing) and connecting a Bluetooth device” (🔗 p. 11) for details on how to pair devices.
- The Bluetooth indicator on the headphones lights blue for approximately 5 seconds when the Bluetooth connection is complete.



- 3** Turn on the Bluetooth function of the 1st Bluetooth device, and select “DENON AH-GC20” from the list of devices displayed on the screen

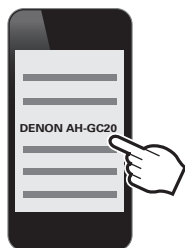

- This procedure connects two Bluetooth devices to the headphones.

## ■ Switching Bluetooth playback devices

- 1** Stop or pause playback on the current playback device
- 2** Start playback on the device that you want to listen to

## ■ Call standby

Simultaneous call standby is possible, but the device that receives the call first takes priority. Calls cannot be made simultaneously.



# Listening to music

When using the headphones wirelessly, make sure the Bluetooth function is set to ON for the Bluetooth device. (For details, see the Owner's Manual of the Bluetooth device that you connected.)

## Listening to music using a Bluetooth connection

The paired Bluetooth device is controlled using the control button.

### NOTE

When the headphones are connected using the audio cable, the Bluetooth function is automatically turned off and the Bluetooth device cannot be controlled using the headphones.

### Playback/pause

Press **1** once

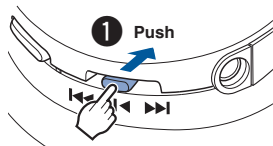

### Select track

Next track: Slide in the **2** direction (towards back of the head)

Previous track: Slide in the **3** direction (towards face)

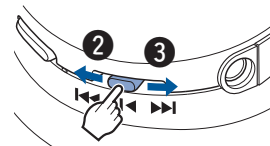

Continue sliding towards **2** for fast-forward playback, and continue sliding towards **3** for rewind playback.

### Volume adjustment

Increase volume (\*1): Press **4**

Decrease volume (\*2): Press **5**



The Bluetooth indicator flashes blue during playback.

- \*1 When the maximum volume is reached, a “beep-beep” sound is heard. The volume cannot be increased further.
- \*2 When the minimum volume is reached, a “beep-beep” sound is heard. The volume cannot be decreased further.





- These headphones are compatible with SCMS-T content security standards. You can use these headphones with SCMS-T compatible mobile phones or devices.
  - In order to listen to music via a Bluetooth connection, the connected Bluetooth device needs to be A2DP (Advanced Audio Distribution Profile) compatible. (\*)
  - In order to control playback on the Bluetooth device, the connected Bluetooth device need to be AVRCP (Audio Video Remote Control Profile) compatible. (\*)
- \* For details on profiles that the Bluetooth device is compatible with, see the Bluetooth device Owner's Manual.

## Listening to music using a wired connection

Use the provided audio cable when you are not allowed to use the Bluetooth function or when the battery runs out.

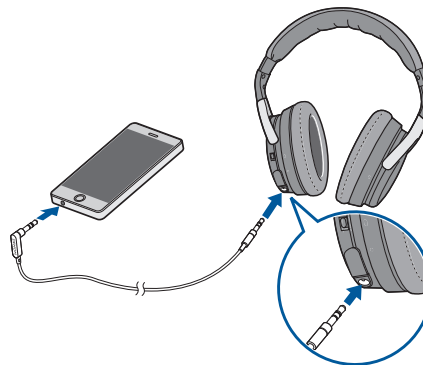

- The noise cancelling function can be used when the headphones are connected by the cable as long as the battery remains charged.

### NOTE

- The call operations and audio device playback operations that are available when connected using Bluetooth cannot be used when the headphones are connected using the cable.
- The noise cancellation function may not operate when the headphones are used with certain portable devices that are equipped with a digital amplifier.



## Decreasing outside noise (Noise cancell function)

Turn the noise cancelling function toggle switch on.

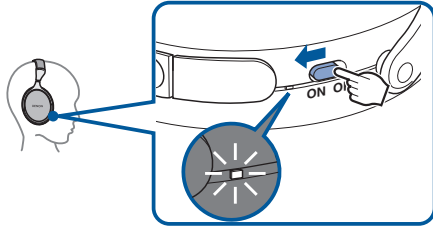

The Charge/NC indicator lights white when the switch is turned on.



## Conducting phone calls

Calls can be made while you are wearing the headphones. You can hear the caller's voice through the headphones, and your voice is picked up by the built-in microphone in the headphones. The paired Bluetooth compatible mobile phone is controlled using the Call button.

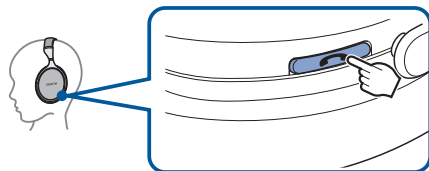

When the headphones are connected using the audio cable, the Bluetooth function is automatically turned off and calls cannot be made using the headphones.

### Making a call

Dial operations are done on the paired mobile phone. Audio playback is paused and the call is connected.

### Answering an incoming call

When an incoming call is received, audio playback is paused and the ring tone is heard.

Press the call button once to answer the call.

### Ending a call

Press the call button once during the call.

When a call is ended, playback of the paused track is restarted.



## Using the call waiting function

If you receive a call while another call is already in progress, you can place the current call (call A) on hold and switch to the new call (call B).

### NOTE

Some of mobile phones may not be compatible with these functions.

### 1 Press the Call button once while the call is in progress.

- This places the current call (call A) on hold and switches to the new call (call B).



When the new call (call B) ends, the unit returns to the call that was on hold (call A).

## ■ To return to the call that is on hold (call A)

### 1 Press and hold the Call button for around 3 seconds during the current call (call B).

- This places the current call (call B) on hold and switches to the call that was previously on hold (call A).

## Ignoring an incoming call

Press and hold the call button for approximately 3 seconds when an incoming call is received.

## Switching a call from the headphones to a mobile phone

Switch the current call to the mobile phone.  
Press the call button three times.

### NOTE

The switch operation cannot be used when a call waiting call is received. Switch using the mobile phone.



## Other operations

<b>Incoming call detected</b>	<b>Answer</b>	Press the call button once
<b>In standby mode/ During audio playback</b>	<b>Voice dial/ Voice activated call</b>	Press and hold the call button
<b>Call in progress</b>	<b>End call</b>	Press the call button once
	<b>Mute on/off</b>	Press the call button twice



- Press the volume button to adjust the volume of the caller's voice.
- The connected Bluetooth device needs to be compatible with either HSP (Headset Profile) or HFP (Hands-free Profile) in order to use the headphones for conducting phone calls. (\*)
- The Bluetooth device needs to be compatible with either HFP or HSP and A2DP in order to conduct calls during audio playback. (\*)

\* For details on profiles that the Bluetooth device is compatible with, see the Bluetooth device Owner's Manual.



## Information

---

### Airplane use

Use the supplied audio cable and conversion plug for aircraft use in order to listen to the on-board audio services on an aircraft.

#### NOTE

- The supplied conversion plug may not be usable depending on the type of aircraft.
- Do not use these headphones when the use of electric devices on the aircraft is prohibited, or when the use of personal headphones to listen to on-board music services is prohibited.

### Storage in the carrying case

Remove the cable and plug from the headphones, fold and insert them into the case.

#### NOTE

Do not force them into the carrying case. Doing so may damage the headphones.



# Troubleshooting

If the headphones do not operate correctly, first check the following items.

Symptom	Cause / Solution	Page
The Bluetooth function of the headphones does not switch on.	<ul style="list-style-type: none"> <li>Connect the headphones to a computer using the supplied USB cable to charge the battery.</li> </ul>	<u>7</u>
Cannot pair a Bluetooth device.	<ul style="list-style-type: none"> <li>Move the Bluetooth device that you want to connect closer to the headphones.</li> </ul>	—
Cannot connect using Bluetooth.	<ul style="list-style-type: none"> <li>Check that the power of the headphones is switched on.</li> </ul>	<u>15</u>
	<ul style="list-style-type: none"> <li>Check that the power of the Bluetooth device is on and the Bluetooth function is enabled.</li> </ul>	<u>11</u>
	<ul style="list-style-type: none"> <li>Check whether the Bluetooth device is in sleep status.</li> </ul>	—
	<ul style="list-style-type: none"> <li>Pair the devices again.</li> </ul>	<u>11</u>
	<ul style="list-style-type: none"> <li>Remove the cable from the headphones if the headphones and Bluetooth device are connected using a cable. The Bluetooth function of the headphones is automatically turned off when the headphones are connected using a cable.</li> </ul>	<u>20</u>
Sound is not output from the headphones when connected using Bluetooth.	<ul style="list-style-type: none"> <li>Check that the power of the headphones is switched on.</li> </ul>	<u>15</u>
	<ul style="list-style-type: none"> <li>Check that the power of the Bluetooth device is on and the Bluetooth function is enabled.</li> </ul>	<u>11</u>
	<ul style="list-style-type: none"> <li>Select A2DP as the Bluetooth connection profile on the transmitting Bluetooth device. For details, see the Owner's Manual of the Bluetooth device.</li> </ul>	—
	<ul style="list-style-type: none"> <li>Check that audio is being played back on the Bluetooth device.</li> </ul>	—
	<ul style="list-style-type: none"> <li>Increase the volume. Increase the volume on the Bluetooth device if it is necessary to adjust the volume on the Bluetooth device.</li> </ul>	<u>19</u>
	<ul style="list-style-type: none"> <li>Pair the devices again.</li> </ul>	<u>11</u>



Symptom	Cause / Solution	Page
Cannot operate the Bluetooth device using the headphones.	<ul style="list-style-type: none"> <li>Remove the cable from the headphones if the headphones and Bluetooth device are connected using a cable. The Bluetooth function of the headphones is automatically turned off when the headphones are connected using a cable.</li> </ul>	<u>20</u>
	<ul style="list-style-type: none"> <li>The headphones are reset when the supplied USB cable is connected to the headphones. Pairing information with Bluetooth devices is not deleted even when the headphones are reset.</li> </ul>	—
Cannot hear the caller's voice.	<ul style="list-style-type: none"> <li>When listening to audio through the headphones, press the call button to switch to the call.</li> </ul>	<u>22</u>
	<ul style="list-style-type: none"> <li>Check that the power of the headphones is switched on.</li> </ul>	<u>15</u>
	<ul style="list-style-type: none"> <li>Check that the power of the Bluetooth device is on and the Bluetooth function is enabled.</li> </ul>	<u>11</u>
	<ul style="list-style-type: none"> <li>Select HSP or HFP as the Bluetooth connection profile on the transmitting Bluetooth device. For details, see the Owner's Manual of the Bluetooth device.</li> </ul>	—
	<ul style="list-style-type: none"> <li>Check that the Bluetooth device is set to handle calls through the headphones. For details, see the Owner's Manual of the Bluetooth device.</li> </ul>	—
	<ul style="list-style-type: none"> <li>Increase the incoming call volume.</li> </ul>	<u>24</u>
	<ul style="list-style-type: none"> <li>Increase the volume on the Bluetooth compatible mobile phone.</li> </ul>	—



## Precautions for Use

---

- Be sure to read the Owner's Manual of the device that you want to connect.
- Check the volume settings when using the headphones on public transport or in public places and make sure you do not disturb people around you.
- These headphones are not guaranteed to work with all combinations of Bluetooth devices/mobile phones.
- These headphones do not support connection with all Bluetooth devices/mobile phones.
- Bluetooth wireless technology can communicate over a distance of approximately 10 m. However, obstructions (people, metallic objects, walls, etc.) and radio wave conditions affect the range in which communication is possible.
- The Bluetooth device that you want to connect must support the same profile as these headphones in order to use the Bluetooth function. For details on profiles that the Bluetooth device is compatible with, see the Bluetooth device Owner's Manual.
- Due to features of Bluetooth wireless technology, playback of audio on the headphones is slightly delayed compared to the voice/audio playback on the transmitting device.



## Disposal of these headphones

---

The rechargeable battery built into these headphones can be recycled. Contact the Denon Customer Service Center for details on disposing of these headphones.

## Trademark information

---



The Bluetooth® word mark and logos are registered trademarks owned by Bluetooth SIG, Inc. and any use of such marks by D&M Holdings Inc. is under license. Other trademarks and trade names are those of their respective owners.



©2013 CSR plc and its group companies.



# Specifications

---

## ■ Headphone section

Type:	Dynamic type
Drive units:	40 mm
Input impedance:	100 $\Omega$ /ohms (Power on)
Sensitivity:	102 dB/mW
Maximum input:	1,000 mW
Playback frequency:	5 – 40,000 Hz

## ■ Bluetooth section

Compatible standards:	Bluetooth 4.0 dual mode
Transmission power:	Max. transmission power 10 mW (Class 1)
Compatible profiles:	A2DP/AVRCP/HSP/HFP
A2DP codec support:	aptX Low Latency/aptX/AAC/SBC
Continuous playback time	
Bluetooth function ON + noise cancellation function ON:	Approx. 20 hours



## ■ General

Operating temperature range:	5 °C - 40 °C
Power supply:	DC 3.7 V (internal lithium polymer rechargeable battery)
Weight:	275 g

\* For purposes of improvement, specifications and design are subject to change without notice.





DENON®  
[www.denon.com](http://www.denon.com)

D&M Holdings Inc.  
3520 10367 00ADB