

Operating and installation instructions Combi steam oven



To avoid the risk of accidents or damage to the appliance it is **essential** to read these instructions before it is installed and used for the first time.

Contents

Warning and Safety instructions	8
Caring for the environment	18
Guide to the appliance	19
Steam oven	19
Accessories supplied	21
Controls	24
On/Off sensor control	25
Movement sensor	25
Sensor controls	26
Touch display	27
Symbols	28
Using the appliance	29
Selecting a menu option	29
Scrolling	29
Exiting a menu	29
Changing a value or setting	29
Changing a setting in a list	29
Entering numbers with the roller	29
Entering numbers using the numerical keypad	29
Changing the setting with a segment bar	30
Entering letters	30
Displaying the context menu	30
Moving entries	30
Displaying the pull-down menu	31
Displaying Help	31
Activating MobileStart	31
Description of functions	32
Control panel	32
Water container	32
Condensate container	32
Food probe	32
Temperature/core temperature	32
Moisture	33
Cooking duration	33
Noises	33
Heating-up phase	34
Cooking phase	34
Steam reduction	34
Oven interior lighting	34

Before using for the first time	35
Miele@home	35
Basic settings	36
Cleaning for the first time	37
Set the correct boiling point for water	38
Heating up the steam oven	39
Settings	40
Settings overview	40
Opening the “Settings” menu	43
Language 	43
Time	43
Date	44
Lighting	44
Start screen	45
Display	45
Volume	46
Units	46
Keeping warm	46
Steam reduction	47
Recommended temperatures	47
Booster	48
Automatic rinsing	48
Water hardness	49
Proximity/Movement sensor	50
Safety	51
Furniture front recognition	52
Miele@home	52
Remote control	53
Activating MobileStart	53
SuperVision	54
RemoteUpdate	55
Software version	56
Legal information	56
Showroom programme	56
Factory default	56
Alarm + minute minder	57
Using the Alarm function	57
Using the Minute minder function	58
Main and sub-menus	59
Energy saving tips	61

Contents

Operation	63
Changing values and settings for a cooking programme.....	64
Changing the temperature and core temperature	65
Changing the Moisture	65
Setting cooking durations	65
Changing the set cooking durations	66
Deleting the set cooking durations.....	66
Cancelling a cooking programme	67
Interrupting a cooking programme.....	67
Pre-heating the oven compartment	68
Booster.....	68
Pre-heat.....	69
Crisp function	69
Releasing bursts of steam.....	70
Changing the function	71
General notes	72
The advantages of cooking with steam	72
Suitable containers.....	72
Shelf level	73
Frozen food.....	73
Temperature	73
Cooking duration	73
Cooking with liquid.....	73
Your own recipes - steam cooking.....	73
Universal tray and combi rack.....	74
Steam cooking	75
Eco Steam cooking	75
Notes on the cooking tables	75
Vegetables.....	76
Fish.....	79
Meat	82
Rice	84
Grain	85
Pasta	86
Dumplings	87
Dried pulses	88
Hen's eggs	90
Fruit	91
Sausages.....	91
Shellfish	92
Mussels	93
Menu cooking (cooking whole meals) - manually	94

Sous-vide (vacuum) cooking	96
Special applications	104
Reheat	104
Defrost	106
Mix & Match	109
Blanching.....	120
Bottling	120
Bottling cakes.....	123
Drying food.....	124
Prove dough	125
Menu cooking – automatic	125
Disinfect items	126
Heat crockery	127
Keeping warm	127
Heating damp flannels	128
Dissolve gelatine	128
Decrystallise honey	129
Melt chocolate.....	129
Make yoghurt	130
Cook bacon	131
Sweat onions.....	131
Extracting juice with steam	132
Fruit preserve.....	133
Skinning vegetables and fruit.....	134
Apple storage	135
Making eierstich	135
Automatic programmes	136
Categories	136
Using automatic programmes	136
Usage notes	136
Search	137
MyMiele	138
User programmes	139
Baking	143
Baking tips.....	143
Tips on baking.....	144
Notes on the functions	144

Contents

Roasting	146
Tips for roasting	146
Notes on the functions	146
Food probe	148
Grilling	152
Grilling tips	152
Tips for grilling	152
Notes on the functions	153
Note for test institutes	154
Cleaning and care	156
Important information on cleaning and care	156
Cleaning the steam oven front	157
PerfectClean	158
Oven compartment	159
Cleaning the water container and condensate container	160
Accessories	161
Cleaning the side runners	162
Lowering the top heat/grill element	163
Maintenance	164
Soaking	164
Drying	164
Rinsing	164
Descaling the steam oven	164
Door removal	166
Fitting the door	167
Problem solving guide	168
Optional accessories	175
Containers	175
Other	175
Cleaning and care products	175
Service	176
Contact in the event of a fault	176
Warranty	176
Installation	177
Safety instructions for installation	177

Building-in dimensions	178
Installation in a tall unit.....	178
Installation in a base unit.....	179
Side view	180
Swivel range for control panel.....	181
Connection and ventilation.....	182
Installing the steam oven.....	183
Electrical connection.....	184
Conformity declaration	186
Copyrights and Licences	187

Warning and Safety instructions

The Combi steam oven is referred to in the following instructions as a steam oven.

This steam oven complies with all applicable safety requirements. Inappropriate use can, however, lead to personal injury and material damage.

Read the operating and installation instructions carefully before using the steam oven. They contain important information on safety, installation, use and maintenance. This prevents both personal injury and damage to the steam oven.

In accordance with standard IEC/EN 60335-1, Miele expressly and strongly advises that you read and follow the instructions in the chapter on installing the steam oven as well as the safety instructions and warnings.

Miele cannot be held liable for injury or damage caused by non-compliance with these instructions.

Keep these instructions in a safe place and pass them on to any future owner.

Correct application

- ▶ This steam oven is intended for use in domestic households and similar working and residential environments.
- ▶ This steam oven is not intended for outdoor use.
- ▶ The steam oven is intended for domestic use only to steam-cook, bake, roast, grill, defrost and reheat food. All other types of use are not permitted.
- ▶ The steam oven can only be used by people with reduced physical, sensory or mental capabilities, or lack of experience and knowledge, if they are supervised whilst using it, or have been shown how to use it in a safe way and recognise and understand the consequences of incorrect operation.
- ▶ This steam oven is supplied with a special lamp to cope with particular conditions (e.g. temperature, moisture, chemical resistance, abrasion resistance and vibration). This special lamp must only be used for the purpose it is intended for. It is not suitable for room lighting. Replacement lamps may only be fitted by a Miele authorised person or by Miele Service.

Warning and Safety instructions

Safety with children

- ▶ Activate the system lock to ensure that children cannot switch on the steam oven inadvertently.
- ▶ Children under 8 years of age must be kept away from the steam oven unless they are constantly supervised.
- ▶ Children aged 8 and older may only use the steam oven without supervision if they have been shown how to use it in a safe manner. Children must be able to understand and recognise the possible dangers caused by incorrect operation.
- ▶ Children must not be allowed to clean the steam oven unsupervised.
- ▶ Please supervise children in the vicinity of the steam oven and do not let them play with it.
- ▶ Risk of suffocation due to packaging material. Whilst playing, children may become entangled in packaging material (such as plastic wrapping) or pull it over their head, presenting the risk of suffocation. Keep packaging material away from children.
- ▶ Risk of injury caused by hot surfaces. Children's skin is far more sensitive to high temperatures than that of adults. External parts of the steam oven such as the door glass, control panel and the vent become quite hot. Do not let children touch the steam oven when it is in operation.
Keep children well away from the steam oven until it has cooled down and there is no danger of injury.

Warning and Safety instructions

- ▶ Risk of injury from the open door.

The oven door can support a maximum weight of 10 kg. Children could injure themselves on an open door.

Do not let children sit on the open door, lean against it or swing on it.

- ▶ If you touch the  sensor control, the door will fully open automatically. In doing so, it can knock against small children or animals, for example.

If the buzzers are switched on, a buzzer will sound on the steam oven when you open the door via remote control using a voice-based service. When opening the door, make sure that nobody is in the area around the door. Make sure that you keep the buzzers switched on.

Warning and Safety instructions

Technical safety

- ▶ Unauthorised installation, maintenance and repairs can cause considerable danger for the user. Installation, maintenance and repairs must only be carried out by a Miele authorised technician.
- ▶ Never use a damaged steam oven. It could be dangerous. Check it for visible signs of damage before using it.
- ▶ Reliable and safe operation of this steam oven can only be assured if it has been connected to the mains electricity supply.
- ▶ The electrical safety of this appliance can only be guaranteed when correctly earthed. It is essential that this standard safety requirement is met. If in any doubt please have the electrical installation tested by a qualified electrician.
- ▶ Before connecting the appliance to the mains supply, ensure that the connection data on the data plate (voltage and frequency) match the mains electricity supply.
This data must correspond in order to avoid the risk of damage to the appliance. Consult a qualified electrician if in any doubt.
- ▶ Do not connect the steam oven to the mains electricity supply by a multi-socket adapter or an extension lead. These do not guarantee the required safety of the appliance (fire hazard).
- ▶ For safety reasons, this steam oven may only be used when it has been built in. This is necessary to ensure that all electrical components are shielded.
- ▶ This steam oven must not be used in a non-stationary location (e.g. on a ship).
- ▶ Risk of injury due to electric shock. Any contact with live connections or tampering with the electrical or mechanical components of the oven will endanger your safety and may lead to the steam oven malfunctioning.
Do not open the steam oven housing under any circumstances.

Warning and Safety instructions

- ▶ While the appliance is under warranty, repairs should only be undertaken by a Miele authorised service technician. Otherwise the warranty is invalidated.
- ▶ Miele can only guarantee the safety of the appliance when genuine original Miele replacement parts are used. Faulty components must only be replaced by Miele spare parts.
- ▶ If the plug is removed from the connection cable or if the cable is supplied without a plug, the appliance must be connected to the electrical supply by a suitably qualified electrician.
- ▶ If the mains connection cable is damaged, it must be replaced with a special mains connection cable (see “Electrical connection” in the “Installation” chapter).
- ▶ During installation, maintenance and repair work, the appliance must be disconnected from the mains electricity supply.
- ▶ If the steam oven is installed behind a furniture front (e.g. a door), do not close the furniture front while the steam oven is in use. Heat and moisture can build up behind the furniture front when closed. This can result in damage to the steam oven, the housing unit and the floor. Leave the furniture door open until the steam oven has cooled down completely.
- ▶ In areas which may be subject to infestation by cockroaches or other vermin, pay particular attention to keeping the appliance and its surroundings clean at all times. Any damage caused by cockroaches or other vermin will not be covered by the warranty.

Warning and Safety instructions

Correct use

▶ Risk of injury caused by hot surfaces and steam. The steam oven gets hot during operation. You could burn yourself on the heater elements, oven compartment, side runners, accessories, door glass, food or steam.

Wear oven gloves when placing hot food in the oven or removing it, when adjusting oven shelves etc. in a hot oven compartment and when closing the door.

▶ Risk of injury caused by hot food.

Food may spill or splash around when placing it into the oven or removing it. The food can cause burns.

When placing cooking containers into the oven or removing them, make sure that the hot food does not spill.

▶ Do not use the steam oven to heat up or bottle food in sealed jars and tins.

Pressure will build up inside them and they can explode causing damage to the appliance, as well as the risk of injury and scalding.



▶ Plastic containers which are not suitable for use in an oven melt at high temperatures and can damage the steam oven or catch fire.

Only use plastic containers which are declared by the manufacturer as being suitable for use in an oven. Follow the manufacturer's instructions on use. If you want to use plastic containers for steaming food make sure that they are temperature resistant to 100 °C and steam resistant. Any other plastic containers could melt, become brittle or break when subjected to heat.

▶ Food which is stored in the oven compartment can dry out and the moisture released can lead to corrosion damage in the steam oven. Do not leave food in the oven compartment and do not use any cooking containers which are susceptible to corrosion.

▶ Risk of injury from the open door. You could bang into the open door or trip over it. Avoid leaving the door open unnecessarily.

Warning and Safety instructions

- ▶ The door can support a maximum weight of 10 kg. Do not sit on or lean against an open door, and do not place heavy objects on it. Also make sure that nothing can get trapped between the door and the oven cavity. The steam oven could get damaged.
- ▶ Oil and fat can ignite if overheated. Never leave the steam oven unattended when cooking with oil and fat. If it does ignite do not put the flames out with water. Switch the steam oven off immediately and then suffocate the flames by keeping the oven door closed.
- ▶ Due to the high temperatures radiated, objects left near the steam oven when it is in use could catch fire. Do not use the steam oven to heat up the room.
- ▶ Grilling food for excessively long cooking durations can cause it to dry out with the risk of catching fire. Do not exceed the recommended cooking durations.
- ▶ Some types of food dry out quickly and can self-ignite if high grill temperatures are used. Never use the grill to finish baking part-cooked rolls or bread or to dry flowers or herbs. Use Fan plus  or Conventional heat  for this type of procedure.
- ▶ To avoid fuelling any flames, do not open the steam oven door if there is smoke inside the oven compartment. Interrupt operation by switching the steam oven off and disconnecting it from the mains electricity supply. Do not open the door until the smoke has dispersed.
- ▶ If using alcohol in your recipes, please be aware that high temperatures can cause the alcohol to vaporise. The vapour can catch fire on hot heating elements.

Warning and Safety instructions

- ▶ Never line the floor of the oven compartment with aluminium foil or oven liners. Do not place any crockery or any pans, pots or baking trays directly on the floor of the oven compartment.
If you want to use the floor of the oven compartment as an extra surface, place the rack on the floor of the oven compartment with the rack surface facing up and the cooking container on top. In doing so, ensure that the filter in the floor of the oven is not moved.
- ▶ The oven compartment floor can become damaged by the rack being pushed around on it.
Do not push the rack around on the oven compartment floor.
- ▶ Larger deposits of food can block the drain and pump. Always make sure that the filter in the floor of the oven is inserted.
- ▶ When using a small electrical appliance, e.g. a hand-held blender, near the steam oven, care should be taken that the cable of the appliance cannot get trapped by the steam oven door. The insulation on the cable could become damaged, giving rise to an electric shock hazard.
- ▶ Do not operate the steam oven without the lamp cover. Steam could reach electrical components and cause a short circuit. Steam could also damage the electrical components.

Cleaning and care

- ▶ Risk of injury due to electric shock. The steam from a steam cleaning appliance could reach live electrical components and cause a short circuit. Do not use a steam cleaner to clean the appliance.
- ▶ Scratches on the door glass can result in the glass breaking. Do not use abrasive cleaners, hard sponges, brushes or sharp metal tools to clean the door glass.
- ▶ The side runners can be removed (see “Cleaning and care – Cleaning the side runners”). Refit the side runners correctly.
- ▶ Try to avoid the interior walls being splashed with food or liquids containing salt. If it does happen, wipe these away thoroughly to avoid corrosion to stainless steel surfaces inside the cabinet.

Accessories

- ▶ Only use genuine original Miele accessories and spare parts with this appliance. Using accessories or spare parts from other manufacturers will invalidate the warranty and Miele cannot accept liability.
- ▶ Only use the Miele food probe supplied with this oven. If it is faulty, it must only be replaced with a suitable original Miele food probe.
- ▶ The plastic on the food probe can melt at very high temperatures. Do not use the food probe when using the grill functions (exception: Fan Grill ). Do not store the food probe in the oven if it is not in use.

Caring for the environment

Disposal of the packing material

The packaging is designed to protect the appliance from damage during transportation. The packaging materials used are selected from materials which are environmentally friendly for disposal and should be recycled.

Recycling the packaging reduces the use of raw materials in the manufacturing process and also reduces the amount of waste in landfill sites.

Disposing of your old appliance

Electrical and electronic appliances often contain valuable materials. They also contain specific materials, compounds and components, which were essential for their correct function and safety. These could be hazardous to human health and to the environment if disposed of with your domestic waste or if handled incorrectly. Please do not, therefore, dispose of your old appliance with your household waste.



Please dispose of it at your local community waste collection / recycling centre for electrical and electronic appliances, or contact your dealer or Miele for advice. You are also responsible for deleting any personal data that may be stored on the appliance being disposed of. Please ensure that your old appliance poses no risk to children while being stored prior to disposal.

Steam oven

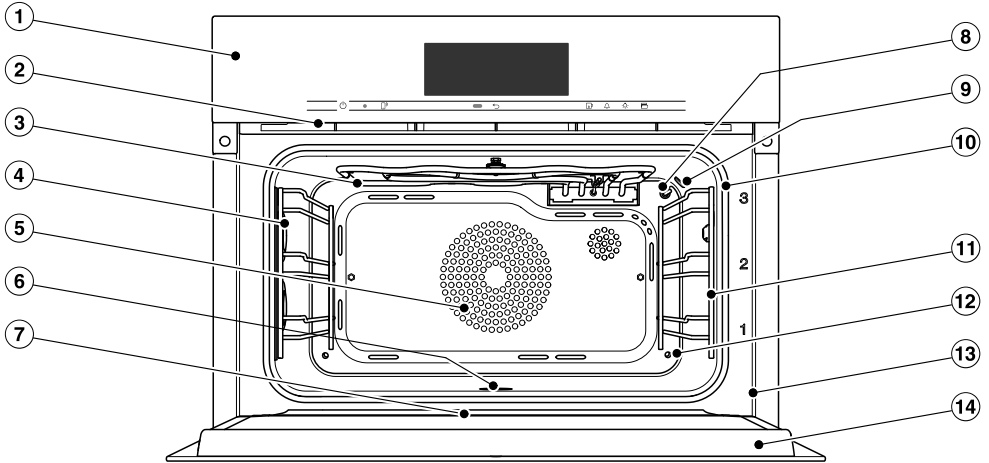

- ① Control elements
- ② Ventilation outlet
- ③ Top heat/grill element with wireless food probe antenna
- ④ Oven interior lighting
- ⑤ Air inlet for the fan with ring heating element behind it
- ⑥ Oven compartment floor with bottom heater element and floor filter underneath it
- ⑦ Drip channel
- ⑧ Temperature sensor
- ⑨ Moisture sensor
- ⑩ Door seal
- ⑪ Side runners with 3 shelf levels
- ⑫ Steam inlet
- ⑬ Front frame with data plate
- ⑭ Door

Guide to the appliance

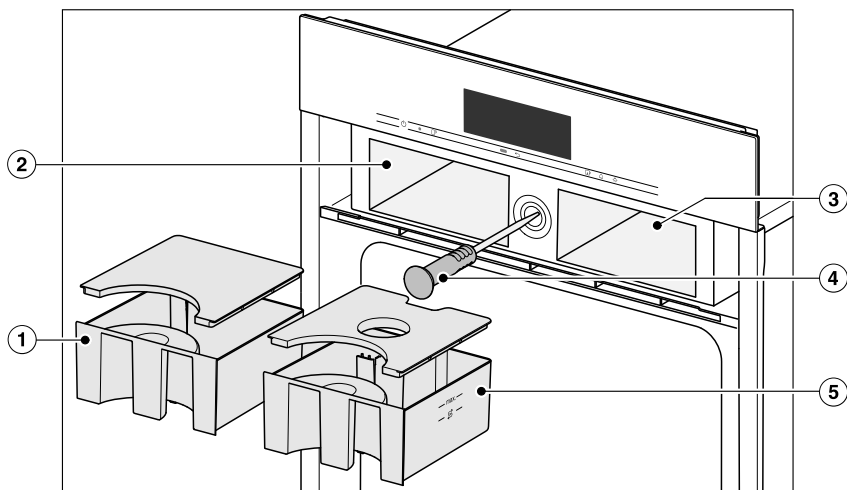

- ① Condensate container
- ② Condensate container compartment
- ③ Compartment for water container
- ④ Wireless food probe
- ⑤ Water container

A list of the models described in these operating and installation instructions can be found on the back page.

Data plate

The data plate is located on the front frame, visible when the door is open.

The data plate states the model number, the serial number as well as connection data (voltage, frequency and maximum rated load).

Please have this information to hand, should you need to contact Miele regarding any questions or problems.

Accessories supplied

The accessories supplied with your appliance as well as a range of optional ones are available to order from Miele (see "Optional accessories").

DGG 20

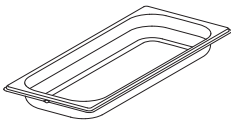

1 solid cooking container
Gross capacity 2.4 l / Usable capacity 1.8 l
450 x 190 x 40 mm (W x D x H)

DGGL 20

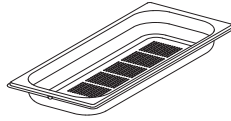

1 perforated cooking container
Gross capacity 2.4 litres / Usable capacity 1.8 litres
450 x 190 x 40 mm (W x D x H)

DGGL 12



1 perforated cooking container
Gross capacity 5.4 litres / Usable capacity 3.3 litres
450 x 390 x 40 mm (W x D x H)

Universal tray

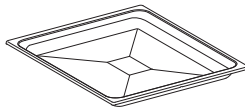

1 universal tray for baking, roasting and grilling

Combi rack



1 combi rack for baking, roasting and grilling

Guide to the appliance

Food probe

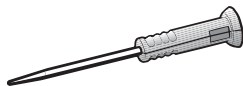

Food probe for precise temperature controlled cooking. The food probe monitors the inner temperature of the meat (core temperature).

Opener



For manually opening the door

DGCLean

Special cleaning agent for removing stubborn soiling from the oven compartment, particularly after roasting.

Descaling tablets

For descaling the appliance

FlexiClip runners HFC 71

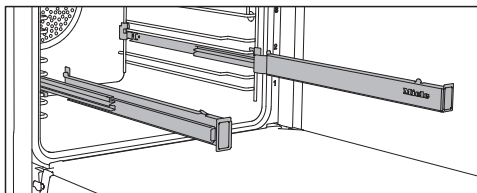

The FlexiClip runners can be attached to any shelf level.

Push the FlexiClip runners fully into the oven compartment before placing accessories on them.

The accessories will then automatically sit securely in between the stoppers at either end of each runner and be prevented from sliding off.

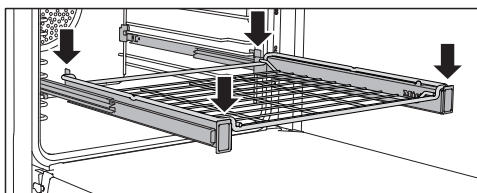
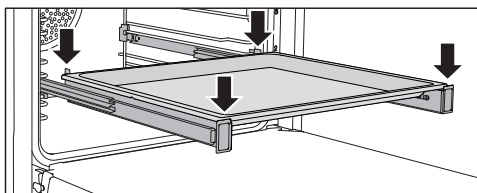

The FlexiClip runners can support a maximum load of 15 kg.

Fitting and removing FlexiClip runners

 Risk of injury caused by hot surfaces.

The steam oven gets hot during operation. You could burn yourself on the heater elements, oven compartment, side runners or accessories. Allow the heater elements, oven compartment, side runners and the accessories to cool before fitting or removing the FlexiClip runners.

The FlexiClip runners are fitted in between the two rails that make up a shelf level.

The FlexiClip runner with the Miele logo should be fitted on the right.

When fitting or removing the FlexiClip runners, **do not** extend them.

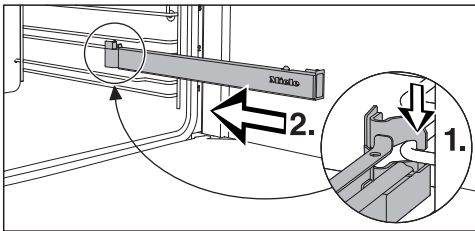

- Hook the FlexiClip runner onto the front of the lower rail of a shelf level (1.) and then push it along the rail into the oven compartment (2.).

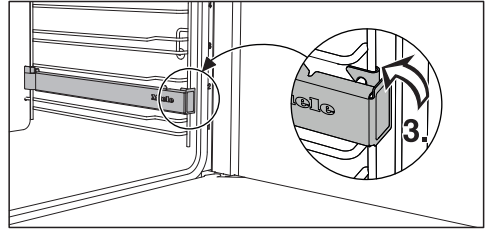

- Then secure the FlexiClip runner to the lower rail of the shelf level (3.).

If the FlexiClip runners are difficult to pull out after fitting, pull firmly on them once to release them.

To remove a FlexiClip runner, proceed as follows:



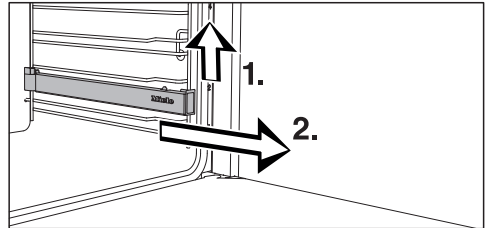



- Push the FlexiClip runner in all the way.

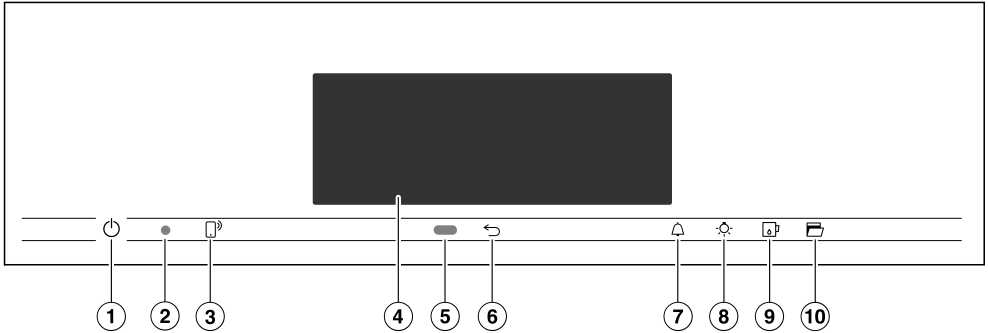

- Remove the FlexiClip runner by raising it at the front (1.) and then pulling it forwards along the rail of the shelf level and out (2.).

Controls



- ① Recessed  On/Off sensor control
For switching the steam oven on and off
- ② Optical interface
(For Miele Service only)
- ③  sensor control
For controlling the steam oven via your mobile device
- ④ Touch display
For displaying information and for operation
- ⑤ Movement sensor
For switching on the oven interior lighting and the display, and to acknowledge the buzzer when movement is detected
- ⑥  sensor control
To go back a step
- ⑦  sensor control
For setting the minute minder or alarms
- ⑧  sensor control
For switching the oven interior lighting on and off
- ⑨ Sensor control 
For opening and closing the control panel
- ⑩  sensor control
For opening the door

On/Off sensor control

The  On/Off sensor control is recessed and reacts to touch.

Use this sensor control to switch the steam oven on and off.

Movement sensor

The movement sensor is located under the touch display next to the  sensor control. The movement sensor detects when you approach the touch display, e.g. with your hand or body.







If you have activated the corresponding settings, you can switch on the oven interior lighting, switch on the steam oven or dismiss the buzzers (see “Settings – Proximity/Movement sensor”).

Controls

Sensor controls

The sensor controls react to touch. Every touch of a sensor control is confirmed with an audible tone. This audible tone can be switched off by selecting the **Volume | Keypad tone | Off** setting.

If you want the sensor controls to respond even when the steam oven is switched off, select the **Display | QuickTouch | On** setting.

Sensor control	Function
	If you want to control the steam oven from your mobile device, you must have the Miele@home system, switch on the Remote control setting and touch this sensor control. The sensor control then lights up orange and the MobileStart function is available. As long as this sensor control is lit, you can control the steam oven via your mobile device (see “Settings – Miele@home”).
	Depending on which menu you are in, this will take you back a level or back to the main menu.
	If a menu appears in the display or if a cooking programme is in progress, you can use this sensor control to set a minute minder (e.g. when boiling eggs) or an alarm (a specific time) at any point (see “Alarm and minute minder”).
	Select this sensor control to switch the oven interior lighting on and off. Depending on the setting selected, the oven interior lighting switches off after 15 seconds or remains constantly switched on or off.
	Use this sensor control to open and close the control panel (see “Control panel” in the “Functional description” chapter).
	Use this sensor control to open the door automatically. To close it, press against the door frame with your hand or with a suitable pot holder or oven glove until the door shuts.

Touch display

The sensitive surface of the touch display can be scratched by pointed or sharp objects, e.g. pens.

Only touch the display with your fingers.

Make sure that water cannot get behind the touch display.

The touch display is split into multiple areas.

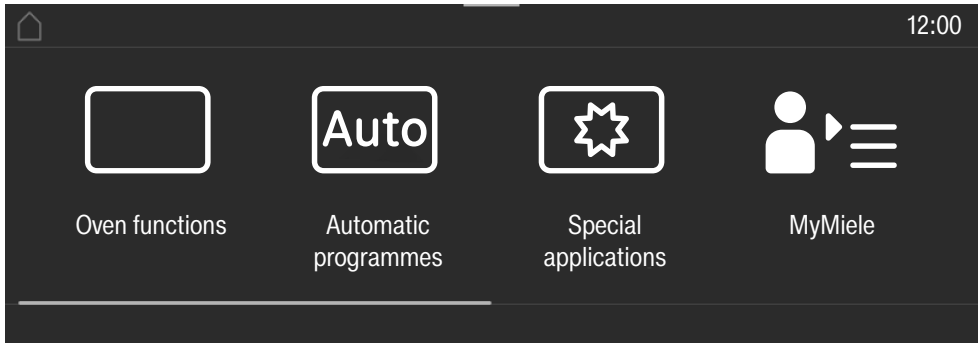

The menu path appears on the left of the **header**. The individual menu options are separated by a vertical line. ... I indicates that there are more options available, which are not visible because there is not enough space in the display.

If you touch a menu name in the header, the display will switch to that menu. To switch to the status display, touch .

The time of day is shown on the right of the header. You can set the time of day by touching the display.

Additional symbols may also appear, e.g. SuperVision .

At the top of the header there is an orange line where you can drag down the pull-down menu. This allows you to switch settings on or off during a cooking programme.

The current menu and menu options are shown in the **centre**. You can scroll to the right or left by swiping your finger across the display to the right or left. Touch a menu option to select it (see "Operation").

The operation fields that appear in the **footer** vary according to the menu that is selected; for example: Timer, Save or OK.

Controls

Symbols

The following symbols may appear in the display:

Symbol	Meaning
	This symbol indicates that there is additional information and advice about using the appliance. Press the <i>OK</i> sensor control to confirm the information.
	This indicates that there are more options available, which are not visible because there is not enough space in the display.
	Water level indicator
	Alarm
	Minute minder
	Some settings, e.g. display brightness and buzzer volume are selected using a bar chart.
	The system lock or sensor lock is on (see “Settings – Safety”). The controls are locked.
	Core temperature when using the food probe
	Remote control (only appears if you are in the Miele@home system and have selected the <i>Remote control On</i> setting)
	SuperVision (only appears if you are in the Miele@home system and have selected the <i>SuperVision SuperVision display On</i> setting)

You operate the steam oven via the touch display by touching the desired menu option.

Each time you touch a possible option, the relevant characters (word and/or symbol) light up **orange**.

Fields for confirming an operating step are highlighted in **green** (e.g. *OK*).

Selecting a menu option

- Touch the field or value you want in the display.

Scrolling

You can scroll left or right.

- Swipe across the screen. To do this, place your finger on the touch display and swipe it in the direction you want.

The bar at the bottom shows you where you are in the current menu.

Exiting a menu

- Touch the ↩ sensor control or touch the ... I symbol in the menu path.
- Touch the ⏏ symbol to switch to the status display.

Entries made before this which have not been confirmed with *OK* will not be saved.

Changing a value or setting

Changing a setting in a list

The current setting is highlighted in orange.

- Touch the desired setting.

The setting is now saved. This will take you back to the previous menu.

Entering numbers with the roller

- Swipe the roller up or down until the value you want is displayed in the centre.

- Confirm with *OK*.

The changed number is now saved.

Entering numbers using the numerical keypad

- Tap on the value that is in the middle of the numerical keypad.

The numerical keypad will appear.

- Touch the desired numbers.

As soon as you enter a valid value, *OK* turns green.

Use the arrow to delete the last entered number.

- Confirm with *OK*.

The changed number is now saved.

Using the appliance

Changing the setting with a segment bar

Some settings are represented by a bar ■■■■■■■ with seven segments. If all of the segments are illuminated, the maximum value is selected.

If none of the segments are illuminated or if only one is, the minimum value is selected or the setting is switched off altogether (e.g. buzzers).

- Touch the corresponding segment on the segment bar to change the setting.
- Select **On** or **Off** to switch the setting on or off.
- Confirm your selection with **OK**.

The setting is now saved. This will take you back to the previous menu.

Entering letters

Letters are entered using a display keyboard. It is best to select short names.

- Touch the desired letters or characters.

Tip: You can add a line break for longer programme names using the **↵** symbol.

- Touch **Save**.

The name is now saved.

Displaying the context menu

In some menus you can display a context menu, e.g. to rename User programmes or to move entries under **MyMiele**.

- For example, touch a User programme and keep your finger on it until the context menu opens.
- To close the context menu, touch an area of the display located outside of the menu window.

Moving entries

You can change the order of User programmes or entries under **MyMiele**.

- For example, touch a User programme and keep your finger on it until the context menu opens.
- Select **Move**.
- Keep your finger on the highlighted field and drag it to the desired location.

Displaying the pull-down menu

During a cooking programme, you can switch settings such as **Booster** or **Pre-heat** and the **WiFi** function on or off.

- Use the orange line under the header to drag the pull-down menu down.
- Select the setting you want to change.
Active settings are highlighted in orange. Depending on the selected colour scheme, inactive settings are highlighted either in black or white (see “Settings – Display”).
- To close the pull-down menu, drag it back up to the top or touch an area of the display located outside of the menu window.

Displaying Help

Context-sensitive help is available for certain functions. In this case, **Help** appears in the bottom line.

- Touch **Help** to display information in text and pictures.
- Touch **Close** to return to the previous menu.

Activating MobileStart

- Select the  sensor control to activate MobileStart.

The  sensor control lights up. You can operate your steam oven remotely with the Miele@mobile app.

Directly operating the steam oven takes priority over operating it via the remote control function on the app.

You can use MobileStart as long as the  sensor control is lit up.

Description of functions

Control panel

The water container, condensate container and food probe are located behind the control panel. The  sensor is used for opening and closing the control panel. The panel is fitted with a device which will automatically stop it moving if it meets an obstruction whilst opening or closing.

Water container

The maximum filling volume is 1.4 l and the minimum is 1.0 l. There are markings on the water container. The upper marking must never be exceeded.

Water consumption depends on the type of food and the cooking duration. The water may need to be topped up during cooking. Water consumption is increased if the door is opened during cooking.

Fill the water container to the maximum level before each cooking programme involving steam.

Condensate container

Condensate that collects in the appliance from cooking is pumped into the condensate container. The container has a maximum capacity of 1.4 litres.

Food probe

The food probe measures the core temperature in the food, enabling the temperature during the cooking process to be monitored simply and accurately.

Temperature/core temperature

Some functions have a pre-set recommended temperature. The recommended temperature can be altered within the given range for an individual cooking programme, a programme stage or for every time that programme is used (see “Recommended temperatures” in the “Settings” chapter).

The core temperature can also be altered within the given range for an individual programme or a specific programme stage.

Moisture

The Combi mode  function and Re-heat special application use a combination of oven heat and moisture. The moisture level can also be selected within the given range for an individual programme or a specific programme stage.

Depending on the moisture setting, moisture or fresh air is supplied to the oven compartment. When the moisture setting = 0 %, the maximum fresh air supply is implemented and no moisture is supplied. When the moisture setting = 100 %, there is no fresh air supply and the moisture content is at its maximum.

Some food gives off moisture during the cooking process. This moisture from the food also controls the amount of moisture needed. If the required amount of moisture is low, the steam generator may not be activated at all.

Cooking duration

Depending on the function, you can set a cooking duration of between 1 minute and 6, 10 or 12 hours.

The cooking durations of the Automatic, Maintenance and Menu cooking programmes are set at the factory and cannot be altered.

When cooking with steam, as well as for programmes and applications with pure steam operation, the cooking duration does not begin until the set temperature is reached. It starts immediately for all other functions, programmes and applications.



Noises

A humming sound can be heard during operation and after switching off the steam oven. This noise does not indicate incorrect operation or an appliance fault. The noise is made by water being pumped through the system.

When the steam oven is in use, you will hear a fan noise.

Description of functions

Heating-up phase

In all functions, the display shows the temperature in the oven compartment as it rises during the heating-up phase (exceptions: Full grill , Economy grill ).

When cooking with steam, the duration of the heating-up phase will depend on the quantity and the temperature of the food. In general, the heating-up phase will last for approx. 7 minutes. The duration will be longer if you are cooking refrigerated or frozen food. The heating-up phase may also last longer if cooking temperatures are low or if you are using the Sous-vide  cooking function.

Cooking phase

The elapsing remaining time is shown in the display during the cooking phase. When cooking with steam, the cooking phase begins once the set temperature is reached. It starts immediately for all other functions, programmes and applications.

Steam reduction

With steam cooking and combination cooking, the steam reduction function will switch on automatically at the end of a cooking programme which uses a temperature within a certain temperature range. The function stops excessive steam escaping when the door is opened. Steam reduction will appear in the display.

Steam reduction can be switched off (see “Steam reduction” in the “Settings” chapter). With steam reduction switched off, a lot of steam will escape when the door is opened.

Oven interior lighting

For energy-saving reasons, the oven interior lighting has been set at the factory to go out after the programme has begun.

If you want it to stay on all the time the oven is on, you will need to alter the default setting (see “Settings – Lighting”).

If the door is left open at the end of a cooking programme, the oven interior lighting will switch off automatically after 5 minutes.

The lighting can be switched on for 15 seconds by touching the  button on the control panel.

Before using for the first time

Miele@home

Your steam oven is equipped with an integrated WiFi module.

In order to use it, you will need:

- a WiFi network,
- the Miele@mobile app, and
- a Miele user account, which can be created from the Miele@mobile app.

The Miele@mobile app will guide you as you connect your steam oven to your home WiFi network.

Once your steam oven is connected to your WiFi network, you can use the app for a number of actions, including the following:

- Getting information on the operating status of your steam oven
- Retrieving information on your steam oven's current cooking programmes
- Stopping cooking programmes that are in progress

Connecting your steam oven to your WiFi network will increase energy consumption, even when the steam oven is switched off.

Make sure that the signal of your WiFi network is sufficiently strong in the place where your steam oven is installed.

Availability of the WiFi connection

The WiFi connection shares a frequency range with other appliances (including microwave ovens and remote control toys). This can give rise to sporadic or even complete connection failures. Therefore, the availability of featured functions cannot be guaranteed.

Miele@home availability

The ability to use the Miele@mobile app depends on the availability of the Miele@home service in your country.

The Miele@home service is not available in every country.

For information about availability, please visit www.miele.com.

Miele@mobile App

The Miele@mobile App is available to download free of charge from the Apple App Store® or from the Google Play Store™.



Before using for the first time

Basic settings

The following settings must be made before starting up for the first time. You can change these settings again at a later time (see “Settings”).

 Risk of injury caused by hot surfaces.

The steam oven gets hot during operation.

For safety reasons, the steam oven may only be used when it has been fully installed.

The steam oven will switch on automatically when it is connected to the electricity supply.

Setting the language

- Select the desired language.

If you have selected the wrong language by mistake, proceed as described in “Settings –  Language”.

Setting the location

- Select the desired location.

Setting up Miele@home

Set up Miele@home? will appear in the display.

- To set up Miele@home now, select *Continue*.
- To set it up at a later date, select *Skip*. See “Settings – Miele@home” for information on setting up at a later date.
- To set up Miele@home now, select the desired connection method.

You will then be guided by the display and the Miele@mobile app.

Setting the date

- Set the day, then the month, and finally the year.
- Confirm with *OK*.

Setting the time

- Set the time of day in hours and minutes.
- Confirm with *OK*.

Before using for the first time

Setting the water hardness level

Contact your local water supplier to find out the hardness of the water in your area.

More information can be found under “Settings – Water hardness”.

- Select your local water hardness on the appliance.
- Confirm with *OK*.

Completing the commissioning process

- Follow any further instructions in the display.

The oven is now ready for use.

Cleaning for the first time

- Remove any protective wrapping and stickers from the steam oven and accessories.



The appliance has undergone a function test in the factory. Residual water from this testing may have trickled back into the cabinet during transportation.

Cleaning the water container and condensate container

 Risk of injury caused by control panel.

You could get caught in the panel as it opens or closes.

Do not touch the upper edge of the door when the panel is opening and closing.

- Switch the steam oven on using the On/Off  button.
- Select the  sensor control to open the control panel.
- Remove the water container and condensate container. Remove the water container and condensate container by pushing it upwards slightly.
- Rinse the water container and condensate container by hand or in the dishwasher.

Before using for the first time

Cleaning accessories/oven compartment

- Take all accessories out of the oven compartment.
- Wash the cooking containers by hand or in the dishwasher.

The universal tray and combi rack surfaces are treated with PerfectClean and must **only** be washed by hand. See “PerfectClean” in the “Cleaning and care” chapter.

- Clean the universal tray and the combi rack with a clean sponge and a solution of hot water and washing-up liquid.

The interior of the steam oven has been treated at the factory with a conditioning agent.

- To remove this, clean the oven compartment with a clean sponge and a mild solution of washing-up liquid and hot water.

Set the correct boiling point for water

Before cooking food for the first time, you must adjust the steam oven to the boiling temperature of the water, which varies depending on the altitude of where the steam oven is located. This process also flushes out the components of the appliance that carry water.

This procedure **must** be carried out to ensure trouble-free functioning of your appliance.

Distilled water, carbonated water and other liquids may damage the steam oven.

Only use cold, fresh tap water (below 20 °C).

- Remove the water container and fill it up to the maximum marker.
- Push the water container into the appliance.
- Then run the steam oven for 15 minutes using the Steam cooking  function (100 °C). Proceed as described in “Operation”.

Setting the correct boiling point for water following a house move

If you move house, the boiling point for the water in the steam oven will need to be re-set for the new altitude if this differs from the old one by 300 m or more. To do this, descale the appliance (see “Care” in the “Cleaning and care” chapter).

Heating up the steam oven

- Take all accessories out of the oven compartment if applicable.
- To remove the grease from the ring heating element, heat the steam oven up at 200 °C using the Fan plus  function for 30 minutes. Proceed as described in the “Operation” chapter.

 Risk of injury caused by hot surfaces.

The steam oven gets hot during operation. You could burn yourself on the heater elements, oven compartment, side runners or door glass.





Wear oven gloves when adjusting oven shelves etc. in a hot oven compartment and when closing the hot door.

The heater element will give off a slight smell when it is heated for the first time. The smell and any vapours given off will dissipate after a while and do not indicate a faulty connection or appliance.

Ensure that the kitchen is well ventilated during this operation.

Settings

Settings overview

Menu option	Available settings
Language 	... deutsch english ... Location
Time	Display On* Off Night dimming Clock type Analogue* Digital Clock format 24 h* 12 h (am/pm) Set
Date	
Lighting	On "On" for 15 seconds* Off
Start screen	Main menu* Oven functions Automatic programmes Special applications User programmes MyMiele
Display	Brightness  Colour scheme Bright Dark* QuickTouch On Off*
Volume	Buzzer tones  Keypad tone  Welcome melody On* Off
Units	Weight g* lb lb/oz Temperature °C* °F

* Factory default setting

Menu option	Available settings
Keeping warm	On Off*
Steam reduction	On* Off
Recommended temperatures	
Booster	On* Off
Automatic rinse	On* Off
Water hardness	1 °dH ... 15 °dH* ... 70 °dH
Movement sensor	Switch light on during cooking process* Always on Off Switch the appliance on On Off* Acknowledge buzzer On* Off
Safety	System lock  On Off* Sensor lock On Off*
Furniture front recognition	On Off*
Miele@home	Activate Deactivate Connection status Set up again Reset Set up
Remote control	On* Off
SuperVision	SuperVision display On Off* Display in standby On Only if there is a fault* Appliance list Display this appliance Buzzer tones

* Factory default setting

Settings

Menu option	Available settings
RemoteUpdate	On* Off
Software version	
Legal information	Open source licences
Showroom programme	Demo mode On Off*
Factory default	Appliance settings User programmes MyMiele Recommended temperatures

* Factory default setting

Opening the “Settings” menu

In the  Settings menu, you can personalise your steam oven by adjusting the factory default settings to suit your requirements.

From the main menu:

- Select  Settings.
- Select the desired setting.



You can check settings or change them.

Settings cannot be changed while a cooking programme is in progress.

Language

You can set the desired language and location.

After selecting and confirming your choice, the language you have selected will appear in the display.

Tip: If you have selected the wrong language by mistake, select  in the main menu. Follow the  symbol to get back to the Language  sub-menu.

Time

Display

Select how you want the time of day to show in the display when the steam oven is switched off:

- On
The time is always visible on the display.
If you also select the Display | Quick-Touch | On setting, all sensor controls react to touch straight away and the movement sensor automatically detects when you approach the display. If you also select the Display | Quick-Touch | Off setting, the steam oven has to be switched on before it can be used.
- Off
To save energy, the display does not light up. The steam oven has to be switched on before it can be used.
- Night dimming
To save energy the time only shows in the display between 05:00 and 23:00. The display remains dark at all other times.

Settings

Clock type

The time of day can be displayed as Analogue (with a clock face) or Digital (h:min) format.

With the digital display, the date is also shown.

Clock format

The time of day can be displayed in the 24 or 12-hour format (24 h or 12 h (am/pm)).

Set

Set the hours and the minutes.

Tip: If no cooking programme is in progress, touch the time in the header to change it.

If there is a power cut, the current time of day will reappear once power has been restored. The time of day is saved for approx. 150 hours.



If the steam oven has been connected to a WiFi network and signed into the Miele@mobile app, the time will be synchronised based on the location setting in the Miele@mobile app.

Date

Set the date.

When the steam oven is switched off, the date will only appear in the display if Time | Clock type | Digital is selected.

Lighting

- On
The oven interior lighting is switched on during the entire cooking period.
- "On" for 15 seconds
The oven interior lighting switches off 15 seconds after a cooking programme has begun. Press the  sensor control to switch the oven interior lighting on again for 15 seconds.
- Off
The oven interior lighting is switched off. Press the  sensor control to switch on the oven interior lighting for 15 seconds.

Start screen

The steam oven is factory-set for the main menu to appear when the steam oven is switched on. You can change this default setting so that, for instance, the oven functions or MyMiele settings appear in the status display straight away (see “MyMiele”).



This new status display will then appear when the steam oven is next switched on.

Select the  sensor control or follow the path in the header to get to the main menu.

Display

Brightness

The display brightness is represented by a bar with seven segments.

-  Maximum brightness
-  Minimum brightness

Colour scheme

Choose between a light or dark colour scheme for the display.

- Bright
The display has a light background with dark characters.
- Dark
The display has a dark background with white characters.

QuickTouch

Select how the sensor controls and the movement sensor should respond when the steam oven is switched off:

- On
if you have also selected the Time | Display | On or Night dimming setting, the sensor controls and the movement sensor will also respond when the steam oven is switched off.
- Off
Regardless of whether Time | Display is set, the sensor controls and the movement sensor only respond when the steam oven is switched on, as well as for a certain amount of time after switching it off.

Settings

Volume

Buzzer tones

If buzzers are switched on, a buzzer will sound when the set temperature is reached and at the end of a set time.

If you want to open the door remotely using a voice-based service, make sure that nobody is in the area around the door when opening it. Make sure that you keep the buzzers switched on.

The volume of the buzzers is represented by a bar with seven segments.

- ■■■■■■■■
Maximum volume

- □□□□□□□
Buzzers are switched off

Keypad tone

The volume of the tone that sounds each time you touch a sensor control is represented by a bar with seven segments.

- ■■■■■■■■
Maximum volume

- □□□□□□□
Tone is switched off

Welcome melody

The melody that sounds when you touch the  On/Off sensor control can be switched on or off.

Units

Weight

For automatic programmes, you can set the weight of food in grams (g), pounds/ounces (lb) or pounds (lb/oz).

Temperature

You can set the temperature in degrees Celsius (°C) or degrees Fahrenheit (°F).

Keeping warm

Using the Keeping warm function, you can keep food warm at the end of a steam cooking programme. Food is kept warm at a pre-set temperature for a maximum of 15 minutes. You can cancel the keeping warm process by opening the door.

Please note that delicate food, especially fish, can continue cooking whilst being kept warm.

- On
The Keeping warm function is switched on. When cooking at a temperature of approx. 80 °C or above, this function is active after approx. 5 minutes. The food is kept warm at a temperature of 70 °C.
- Off
The Keeping warm function is switched off.

Steam reduction

The Steam reduction function stops excessive steam escaping when the door is opened.

- On

The steam reduction function will switch on automatically at the end of a cooking programme which uses a temperature of over approx. 80 °C (steam cooking) or 80–100 °C and 100 % moisture (combination cooking). Steam reduction will appear in the display.

- Off

If steam reduction is switched off, the Keeping warm function is also automatically switched off. With steam reduction switched off, a lot of steam will escape when the door is opened.

Recommended temperatures

If you often cook with different temperatures, it makes sense to change the recommended temperatures.

After selecting this menu option, a list of functions will appear in the display.

- Select the desired function.

The recommended temperatures are displayed along with the available temperature range.

- Change the recommended temperatures.
- Confirm with *OK*.

Settings

Booster

The **Booster** function is used to quickly pre-heat the oven compartment.

- On
The **Booster** function is automatically switched on during the heating-up phase of a cooking programme. The top heat/grill element, ring heating element and hot air fan pre-heat the oven compartment to the desired temperature at the same time.
- Off
The **Booster** function is switched off during the heating-up phase of a cooking programme. Only the heating elements associated with the function are pre-heating the oven compartment.

You can also use the pull-down menu to switch the **Booster** function on or off for a cooking programme.

Automatic rinsing

Following a cooking programme with steam, **Appliance rinsing** will appear in the display after the steam oven has been switched off.

This process flushes any remaining food deposits out of the system.

You can activate or deactivate the automatic rinsing process.

Water hardness

The steam oven must be adjusted to the local water hardness level to ensure that it works correctly and to ensure that descaling is carried out at the correct interval. The harder the water is, the more frequently the steam oven needs to be descaled.

Contact your local water supplier to find out the hardness of the water in your area.

If you use bottled water, such as mineral water, make sure it is not carbonated. Adjust this setting depending on the calcium content. The calcium content is specified on the label of the bottle in mg/l Ca²⁺ or ppm (mg Ca²⁺/l).

You can set the hardness level between 1 °dH and 70 °dH. The hardness level is set to 15 °dH by default.

- Select your local water hardness on the appliance.
- Confirm with OK.

Water hardness		Calcium content mg/l Ca ²⁺ or ppm (mg Ca ²⁺ /l)	Setting
°dH	mmol/l		
1	0.2	7	1
2	0.4	14	2
3	0.5	21	3
4	0.7	29	4
5	0.9	36	5
6	1.1	43	6
7	1.3	50	7
8	1.4	57	8
9	1.6	64	9
10	1.9	71	10

Water hardness		Calcium content mg/l Ca ²⁺ or ppm (mg Ca ²⁺ /l)	Setting
°dH	mmol/l		
11	2.0	79	11
12	2.2	86	12
13	2.3	93	13
14	2.5	100	14
15	2.7	107	15
16	2.9	114	16
17	3.1	121	17
18	3.2	129	18
19	3.4	136	19
20	3.6	143	20
21	3.8	150	21
22	4.0	157	22
23	4.1	164	23
24	4.3	171	24
25	4.5	179	25
26	4.7	186	26
27	4.9	193	27
28	5.0	200	28
29	5.2	207	29
30	5.4	214	30
31	5.6	221	31
32	5.8	229	32
33	5.9	236	33
34	6.1	243	34
35	6.3	250	35
36	6.5	257	36
37–45	6.6–8.0	258–321	37–45
46–60	8.2–10.7	322–429	46–60
61–70	10.9–12.5	430–500	61–70

Settings

Proximity/Movement sensor

The movement sensor detects when you approach the touch display, e.g. with your hand or body.

If you want the movement sensor to respond even when the steam oven is switched off, select the **Display | Quick-Touch | On** setting.

Switch light on

- during cooking process
As soon as you approach the touch display during a cooking programme, the oven interior lighting switches on. The oven interior lighting automatically switches off again after 15 seconds.
- Always on
As soon as you approach the touch display, the oven interior lighting switches on. The oven interior lighting automatically switches off again after 15 seconds.
- Off
The movement sensor does not respond when you approach the touch display. Select the  sensor control to switch on the oven interior lighting for 15 seconds.

Switch the appliance on

- On
If the time is displayed, the steam oven switches on and the main menu appears as you approach the touch display.
- Off
The movement sensor does not respond when you approach the touch display. Switch the steam oven on using the On/Off  sensor control.

Acknowledge buzzer

- On
As soon as you approach the touch display, the buzzers switch off.
- Off
The movement sensor does not respond when you approach the touch display. Switch the buzzers off manually.

Safety

System lock

The system lock prevents the steam oven being switched on by mistake.

You can still set an alarm and a minute minder as well as use the MobileStart function when the system lock is active.

The system lock will remain activated even after a mains outage.

- On
The system lock has been activated. If you want to use the steam oven, switch it on and touch the  symbol for at least 6 seconds.
- Off
The system lock is deactivated. You can then use the steam oven as normal.

Sensor lock

The sensor lock prevents the cooking programme being switched off by mistake or settings being changed. Apart from the  On/Off sensor control, the activated sensor lock prevents the sensor controls and fields in the display from working a few seconds after a programme has been started.

- On
The sensor lock is activated. Touch *OK* for at least 6 seconds to deactivate the sensor lock for a short period of time.
- Off
The sensor lock is deactivated. All sensor controls react to touch as normal.

Settings

Furniture front recognition

- On
The furniture front detection is activated. Using the movement sensor, the steam oven automatically detects whether the furniture door is closed.

If the furniture door is closed, the steam oven switches off automatically after a certain period.
- Off
The furniture front detection is deactivated. The steam oven does not detect whether the furniture door is closed.

If the steam oven is installed behind a furniture front (e.g. a door), the steam oven, housing unit and the floor can be damaged by the build-up of heat and moisture behind the closed furniture front.
Always leave the furniture door open when you are using the steam oven. Leave the furniture door open until the steam oven has cooled down completely.

Miele@home

The steam oven is a Miele@home-compatible appliance with SuperVision functionality.

Your steam oven is fitted ex-works with a WiFi communication module and is suitable for wireless communication.

There are a number of ways of connecting your steam oven to your WiFi network. We recommend connecting your steam oven to your WiFi network using the Miele@mobile App or via WPS.

- Activate
This setting is only visible if Miele@home is deactivated. The WiFi function is reactivated.
- Deactivate
This setting is only visible if Miele@home is activated. Miele@home remains set up, the WiFi function is switched off.
- Connection status
This setting is only visible if Miele@home is activated. The display shows information such as the WiFi reception quality, network name and IP address.
- Set up again
This setting is only visible if a WiFi network has already been set up. Reset the network settings and immediately set up a new network connection.

- Reset

This setting is only visible if a WiFi network has already been set up. The WiFi function is deactivated and the WiFi connection will be reset to the factory default. You must set up a new WiFi connection to be able to use Miele@home.

The network settings should be reset whenever a steam oven is being disposed of or sold, or if a used steam oven is being put into operation. This is the only way to ensure that all personal data has been removed and the previous owner will no longer be able to access the steam oven.

- Set up

This setting is only visible if no WiFi connection has been set up yet. You must set up a new WiFi connection to be able to use Miele@home.

Remote control

If you have installed the Miele@mobile app on your mobile device, have access to the Miele@home system and have activated the remote control function (On), you can use the MobileStart function and for example retrieve information about steam oven cooking processes that are in progress or end a process that is in progress.

The steam oven requires max. 2 W when operating in networked standby.

Activating MobileStart

- Select the  sensor control to activate MobileStart.

The  sensor control lights up. You can operate your steam oven remotely with the Miele@mobile app.

Directly operating the steam oven takes priority over operating it via the remote control function on the app.

You can use MobileStart as long as the  sensor control is lit up.

Settings

SuperVision

The steam oven is a Miele@home-compatible appliance with SuperVision functionality for monitoring other household appliances in the Miele@home system.

The SuperVision function cannot be activated until the Miele@home system has been set up.

SuperVision display

- On
The SuperVision function is switched on.
The  symbol will appear in the top right-hand side of the display.
- Off
The SuperVision function is switched off.

Display in standby

The SuperVision function is also available when the oven is in standby. However, the time-of-day display must be switched on (Settings | Time | Display | On).

- On
Active household appliances that are signed into the Miele@home system are always displayed.
- Only if there is a fault
Only faults on active household appliances are shown.

Appliance list

All household appliances signed in to the Miele@home System are shown. Once you have selected an appliance, you can access further settings:

- Display this appliance
 - On
The SuperVision function for this appliance is switched on.
 - Off
The SuperVision function for this appliance is switched off. The appliance is still signed on to the Miele@home system. Faults are displayed, even if the SuperVision function for the appliance has been switched off.
- Buzzer tones
You can select whether the buzzers are switched on (On) or switched off (Off) for this appliance.

RemoteUpdate

The RemoteUpdate menu option is only displayed and can only be selected if the requirements for using Miele@home have been met (see “Before using for the first time – Miele@home”).

The RemoteUpdate function is used for updating the software in your steam oven. If an update is available for your steam oven, it will automatically download it. Updates will not be installed automatically. They must be initiated manually.

If you do not install an update, you can continue to use your steam oven as usual. However, Miele recommends installing updates.

Activating/deactivating

The RemoteUpdate function is activated as standard. Available updates will be downloaded automatically but will only be installed if you initiate installation manually.

Deactivate RemoteUpdate if you do not want any updates to be downloaded automatically.

Running RemoteUpdate

Information about the content and scope of an update will be provided in the Miele@mobile app.

A message will appear in your steam oven display if a software update is available.

You can install the update immediately or postpone this until later. When the steam oven is switched on again, you will be reminded about the update.

Deactivate RemoteUpdate if you do not want to install the update.

The update may take several minutes.

Please note the following information about the RemoteUpdate function:

- You will only receive a message when an update is available.
- Once an update has been installed, it cannot be undone.
- Do not switch the steam oven off during the update. Otherwise, the update will be aborted and will not be installed.
- Some software updates can only be carried out by the Miele Customer Service Department.

Settings

Software version

The software version is intended for the Miele Customer Service Department. You do not need this information for domestic use.

- Confirm with *OK*.

Legal information

You can find an overview of the integrated Open Source components under Open source licences.

- Confirm with *OK*.

Showroom programme

This function enables the steam oven to be demonstrated in showrooms without heating up. This setting is not needed for domestic use.

Demo mode

If you have demo mode activated, Demo mode switched on. The appliance will not heat up **will appear when you switch the steam oven on.**

- On
Touch *OK* for at least 4 seconds to activate demo mode.
- Off
Touch *OK* for at least 4 seconds to deactivate demo mode. You can then use the steam oven as normal.

Factory default

- Appliance settings
Any settings that have been altered will be reset to the factory default settings.
- User programmes
All User programmes will be deleted.
- MyMiele
All MyMiele entries will be deleted.
- Recommended temperatures
Any recommended temperatures that have been changed will be reset to the factory default settings.

Using the  sensor control, you can set a minute minder, e.g. for boiling eggs, or an alarm for a specific time.



Two alarms can be set simultaneously; two minute minder durations or an alarm and a minute minder duration.

Using the Alarm function

The  alarm can be used to specify a particular time for a buzzer to sound.

Setting the alarm

If the Display | QuickTouch | Off setting is selected, you will need to switch the steam oven on before setting the alarm. The alarm time will then appear in the display when the steam oven is switched off.

- Select the  sensor control.
- Select  Alarm.
- Set the time for the alarm.
- Touch **Close** to confirm.

When the steam oven is switched off, the alarm time and  will appear instead of the time of day.

If you are cooking at the same time or if you are in a different menu, the alarm time and  will appear at the top right-hand side of the display.

At the specified time for the alarm,  will flash in the display next to the time and a buzzer will sound.

- Select the  sensor control or the set alarm time in the display.

The buzzer will stop and the symbols in the display will go out.

Changing an alarm

- Select the alarm in the display or select the  sensor control and the desired alarm.

The set alarm time appears in the display.

- Set the new time for the alarm.
- Touch **Close** to confirm.

The adjusted alarm time is now saved and will appear in the display.

Deleting an alarm

- Select the alarm in the display or select the  sensor control and the desired alarm.

The set alarm time appears in the display.

- Select **Delete**.
- Touch **Close** to confirm.

The alarm will be deleted.

Alarm + minute minder

Using the Minute minder function

The  minute minder can be used to time other activities in the kitchen, e.g. boiling eggs.



The minute minder can also be used at the same time as a cooking programme for which the cooking duration start and finish times have been set (e.g. as a reminder to stir the food or add seasoning, etc.).

- The maximum minute minder time that can be set is 59 minutes and 59 seconds.

Setting the minute minder

If you have selected the **Display | Quick-Touch | Off** setting, you will need to switch the steam oven on before setting the minute minder. The minute minder can then be seen counting down in the display when the steam oven is switched off.

Example: you want to boil some eggs and set a minute minder duration of 6 minutes and 20 seconds.

- Select the  sensor control.
- Select  Minute minder.
- Set the minute minder time you require.
- Touch **Close** to confirm.

When the steam oven is switched off the minute minder duration counts down in the display and  appears instead of the time of day.

If you are cooking at the same time or if you are in a different menu, the minute minder duration and  will appear at the top right-hand side of the display.

At the end of the minute minder duration,  will flash, the time will start counting up and a buzzer will sound.

- Select the  sensor control or the desired minute minder in the display.

The buzzer will stop and the symbols in the display will go out.

Changing the minute minder duration

- Select the minute minder in the display or select the  sensor control and then the desired minute minder duration.

The minute minder duration selected will appear.

- Set a new minute minder duration.
- Touch **Close** to confirm.

The changed minute minder duration is now saved and will count down in minutes. Minute minder durations of less than 10 minutes will count down in seconds.

Deleting the minute minder duration





















- Select the minute minder in the display or select the  sensor control and then the desired minute minder duration.

The minute minder duration selected will appear.







- Select **Delete**.
- Touch **Close** to confirm.

The minute minder duration is now deleted.

Main and sub-menus

Menu	Recommended value	Range
Oven functions 		
Fan plus 	160 °C	30–225 °C
Conventional heat 	180 °C	30–225 °C
Combi mode 		
Combi Fan plus 	170 °C	30–225 °C
Combi Conventional 	180 °C	30–225 °C
Combi Grill 	Level 3	Level 1–3
Steam cooking 	100 °C	40–100 °C
Sous-vide 	65 °C	45–90 °C
Intensive bake 	180 °C	50–225 °C
Bottom heat 	190 °C	100–200 °C
Top heat 	190 °C	100–225 °C
Full grill 	Level 3	Level 1–3
Economy grill 	Level 3	Level 1–3
Fan grill 	200 °C	50–225 °C
Cake plus 	160 °C	30–225 °C
Eco Fan heat 	160 °C	30–225 °C
Eco Steam cooking 	100 °C	40–100 °C
Automatic programmes 		
Special applications 		
Reheat	130 °C	120–140 °C
Defrost	60 °C	50–60 °C

Main and sub-menus

Menu	Recommended value	Range
Special applications 		
Mix & Match		
Crispy reheating	–	–
Gentle reheating	–	–
Crispy cooking	–	–
Gentle cooking	–	–
Blanching	–	–
Bottling	90 °C	80–100 °C
Drying	60 °C	60–70 °C
Prove dough	–	–
Menu cooking	–	–
Disinfect items	–	–
Heat crockery	50 °C	50–80 °C
Keeping warm	65 °C	40–100 °C
MyMiele  		
User programmes 		
Settings 		
Maintenance 		
Descalc		
Soak		
Drying		
Rinse		

Cooking programmes

- Remove all accessories from the oven compartment that are not required for cooking.
- In general, if a range of temperatures is given in a recipe or cooking chart, it is best to select the lower temperature and to check the food after the shortest duration.
- Preheat the oven compartment only if instructed to do so in the recipe or the cooking chart.
- If possible, do not open the door during a programme.
- Dark, matt tins are best for baking. These absorb the heat more effectively and transmit the heat to the mixture quicker. Shiny materials such as stainless steel or aluminium reflect the heat and therefore can give a more uneven result. Do not cover the oven floor or the rack with heat-reflecting aluminium foil.
- Monitor cooking durations to avoid wasting energy when cooking. Set the cooking duration, or use a food probe if you have one.
- The Fan plus  function can be used for cooking many types of food. Because the fan distributes the heat in the oven compartment straight away, it allows you to use a lower temperature than you would with Conventional heat . It also enables you to cook on multiple shelf levels at the same time.
- Fan grill  is the best function for grilled dishes. With this function, you can use lower temperatures than in other grill functions which use the maximum temperature setting.
- The Eco Fan heat  function ensures energy-efficient cooking thanks to optimal utilisation of heat. Use this function for sweet and savoury bakes and gratins. Do not open the door during the cooking programme.
- You can use the Eco Steam cooking  function to save energy during steam cooking. This function is particularly suitable for cooking fish and vegetables.
- Whenever possible, you should cook several dishes at the same time. Place them next to each other in the oven or on different shelf levels.
- Dishes which you are unable to cook at the same time should, if possible, be cooked one after the other in order to make use of existing heat in the oven.

Energy saving tips

Settings

- Select the setting **Display | Quick-Touch | Off** for the control elements in order to reduce energy consumption.
- Select the **Lighting | Off** or "On" for 15 seconds setting for the oven interior lighting. The oven interior lighting can be switched on again at any time by touching the  sensor control.

Energy-saving mode

The steam oven will switch itself off automatically to save energy if a programme is not being run and controls have not been operated. The time of day will appear in the display or the display will remain dark (see "Settings").

Malfunction due to missing floor filter.

If the floor filter is missing, food deposits can get into the drain. The water cannot be pumped away.

Before each cooking programme, check that the filter in the floor of the oven compartment is correctly fitted.

- Switch the steam oven on.

The main menu will appear.

- If you want to cook using a steam function or with bursts of steam, fill the water container and reinsert it.

Distilled water, carbonated water and other liquids may damage the steam oven.

Only use cold, fresh tap water (below 20 °C).

- Place the food in the oven compartment.
- Select Oven functions .
- Select the function you want to use.

The function and recommended values for temperature and moisture (if applicable) appear.

- Change the recommended values if necessary.

The recommended values will be automatically accepted within a few seconds. You can change the temperature and moisture level later by selecting the temperature or moisture indicator.

- Confirm with *OK*.

The required and the actual temperature will appear and the heating-up phase will begin.

You will see the temperature increasing. A buzzer will sound when the set temperature is reached for the first time.

- After the cooking programme, select *Finish*.

 Risk of injury caused by hot steam.

When using a cooking programme involving steam, a lot of hot steam can escape if the door is opened.

The steam can cause burns.

Step back and wait until the hot steam has dissipated.

- Take the food out of the oven compartment.

 Risk of injury caused by hot surfaces.

The steam oven gets hot during operation. You can burn yourself on the door glass.

Wear oven gloves when closing the hot door.

Operation

Cleaning the steam oven

- Remove the water container and condensate container and empty them as required.
- Switch the steam oven off.

Appliance rinsing appears after a cooking programme involving steam.

- Follow the instructions on the display.

The rinsing process should be carried out every time to flush any remaining food deposits out of the system.

If you have selected Display | Quick-Touch | Off in the settings menu, you will have to switch the steam oven on in order to open the door.

- Clean and dry the whole steam oven as described in the “Cleaning and care” chapter.
- Leave the appliance door open until the oven compartment is completely dry.

Refilling the water

If water needs replenishing during the programme, a tone will sound and the display will prompt you to refill the container with fresh water.

- Take out the water container and replenish the water.
- Push the water container into the appliance.

The cooking programme is resumed.

Changing values and settings for a cooking programme

Depending on the function, as soon as a cooking programme is in progress, you can change the values or settings for this programme.

Depending on the function, you can change the following settings:

- Temperature
- Moisture
- Duration
- Booster
- Pre-heat
- Crisp function

Changing the temperature and core temperature

Go to Settings | Recommended temperatures to permanently adjust the recommended temperatures to suit your cooking preferences.

The  core temperature only appears if you are using the food probe (see “Roasting – Food probe”).

- Touch the temperature display.
- Change the temperature and the  core temperature if necessary.
- Confirm with *OK*.

The cooking programme will restart with the new desired temperatures.

Changing the Moisture

- Touch the moisture indicator.
- Change the moisture level.
- Confirm with *OK*.

The programme will continue to run at the new moisture level.

Setting cooking durations

Cooking results can be impaired if there is a long delay between the food being placed in the oven and the start of cooking. Fresh food can change colour and even deteriorate. When baking, the cake mixture or dough can dry out, and the raising agents can lose their effectiveness. Select as short as possible a time until the cooking programme starts.

You have placed the food in the oven compartment, selected a function and the required settings such as the temperature.

By entering *Duration*, *Finish at* or *Start at*, you can automatically switch the cooking programme off or on and off.

- *Duration*
Enter the desired cooking duration for the food. The heating will switch off automatically once this duration has elapsed. The maximum cooking duration that can be set depends on the function that you have selected.
- *Finish at*
Specify when you want the cooking programme to end. The oven heating will switch off automatically at the time you have set.
- *Start at*
This function will only appear in the menu if you have set a *Duration* or *Finish at* time. With *Start at*, you have to specify when you want the cooking programme to start. The oven heating will switch on automatically at the time you have set.

Operation

- Select  or **Timer**.
- Set the desired times.
- Confirm with **OK**.

When cooking with steam, the cooking duration does not begin until the set required temperature is reached.

The steam reduction function will switch on at the end of a cooking programme which used a temperature of over approx. 80 °C (steam cooking) or 80–100 °C and 100 % moisture (combination cooking).

- Wait until **Steam reduction** goes out in the display before opening the door and removing the food from the oven compartment.

Changing the set cooking durations

- Select , the duration or **Timer**.
- Select the desired time and change it.
- Confirm with **OK**.

These settings will be deleted in the event of a power failure.

Deleting the set cooking durations

- Select , the duration or **Timer**.
- Select the desired time.
- Select **Delete**.
- Confirm with **OK**.

If you delete **Duration**, the set times for **Finish at** and **Start at** are also deleted.

If you delete **Finish at** or **Start at**, the cooking programme will start using the cooking duration set.

Cancelling a cooking programme

If you cancel a cooking programme, the oven heating and lighting will switch off. Any cooking durations set will be deleted.

Cancelling a cooking programme without a set cooking duration

- Select Finish.

The main menu will appear.

Cancelling a cooking programme with a set cooking duration

- Select Cancel.

Cancel process? appears in the display.

- Select Yes.

The main menu will appear.

Interrupting a cooking programme

A cooking programme is interrupted as soon as the door is opened. The oven heating switches off.

The set cooking duration is saved when cooking with steam as well as for programmes and applications with pure steam operation.

 Risk of injury caused by hot steam.

When using a cooking programme involving steam, a lot of hot steam can escape if the door is opened. The steam can cause burns.

Step back and wait until the hot steam has dissipated.

 Risk of injury caused by hot surfaces and food.

The steam oven gets hot during operation. You could burn yourself on the heater elements, oven compartment, side runners, accessories, food or door glass.

Wear oven gloves when placing hot food in the oven or removing it, when adjusting oven shelves etc. in the hot oven compartment and when closing the hot door.

When placing cooking containers into the oven or removing them, make sure that the hot food does not spill out.

The cooking programme will resume when the door is closed.

The steam oven will heat up again and the display will show the temperature in the oven compartment as it rises. When cooking with steam as well as for programmes and applications with pure steam operation, the remaining time only continues to elapse once the set temperature has been reached.

In programmes using 100 % moisture and temperatures up to 100 °C: the cooking programme will finish early if the door is opened in the last minute of cooking (55 seconds remaining).

Operation

Pre-heating the oven compartment

The **Booster** function is used to quickly pre-heat the oven compartment in some functions.



The **Pre-heat** function can be used with any oven function (except **Eco Fan heat** ) and has to be switched on separately for each cooking programme.

It is only necessary to pre-heat the oven compartment in a few instances.

- Pre-heat the oven compartment when cooking the following food:
 - Cakes and pastries with a short cooking duration (approx. 30 minutes or less) as well as delicate items (e.g. sponge) with the **Conventional heat**  function

Booster

The **Booster** function is switched on as the factory default setting for the following functions (**Settings | Booster | On**):

- Fan plus 
- Conventional heat 

If you set a temperature above 100 °C and the **Booster** function is switched on, a rapid heating-up phase heats the oven compartment to the set temperature. The top heat/grill element and the ring heating element come on together with the hot air fan.

Delicate items (e.g. sponge or biscuits) will get brown too quickly on the top with the **Booster** function. Switch off the **Booster** function for these items.

Switching the Booster on and off for a cooking programme

If you have selected the **Booster | On** setting, you can switch off the function separately for a cooking programme.

On the other hand, you can also switch on the function separately for a cooking programme if you have selected the **Booster | Off** setting.

Example: you have selected a function and the required settings such as the temperature.

You want to switch off the **Booster** function for this cooking programme.

- Drag down the pull-down menu.

Booster is highlighted in orange.

- Select **Booster**.

Depending on the colour scheme, **Booster** is highlighted either in black or white.

- Close the pull-down menu.

The **Booster** function is switched off during the heating-up phase. Only the heating elements associated with the function are pre-heating the oven compartment.

Pre-heat

You can place most dishes in the cold oven compartment to make use of the heat produced during the heating-up phase.

If you have set a cooking duration, it will only start to count down when the desired temperature is reached and you have placed the food in the oven.

Start the cooking programme immediately without delaying the start time.

Switching on Pre-heat

The Pre-heat function has to be switched on separately for each cooking programme.

You have selected a function and the required settings such as the temperature.

■ Drag down the pull-down menu.

Depending on the colour scheme, Pre-heat is highlighted in either black or white.

■ Select Pre-heat.

Pre-heat is highlighted in orange.

Appliance is being pre-heated. Do not insert food yet **appears**.

■ Confirm with *OK*.

■ Close the pull-down menu.

The following message is displayed with a time: Place food in the oven at . The oven compartment is heated to the set temperature.

■ As soon as you are prompted to do so, place the food in the oven compartment.

■ Confirm with *OK*.

Crisp function

The Crisp function function (moisture reduction) allows moisture to be removed from the oven as required during the entire cooking process or at times during the process.

It is a good idea to use this function when cooking items which have a moist topping e.g. quiche, pizza, tray bakes with fresh fruit toppings or muffins.

Poultry in particular gets a good crisp skin with this function.

The Crisp function function can be used in the following functions:

- Fan plus 
- Conventional heat 
- Intensive bake 
- Bottom heat 
- Top heat 
- Fan grill 
- Cake plus 

Operation

Switching on Crisp function

The Crisp function function has to be switched on separately for each cooking programme.

You have selected a function and the required settings such as the temperature.

You want to switch on the Crisp function function for this cooking programme.

- Drag down the pull-down menu.

Depending on the colour scheme, Crisp function is highlighted in either black or white.

- Select Crisp function.

Crisp function is highlighted in orange.

- Close the pull-down menu.

The Crisp function function is switched on.

The Crisp function function can be switched off again at any time via the pull-down menu.

Releasing bursts of steam

You can release bursts of steam during the cooking process in all oven functions (except Eco Fan heat ). The number of bursts of steam is unlimited.

You can release a burst of steam as soon as Burst of steam appears and Start is shown in green.

Please wait until the heating-up phase is completed to allow the steam to be distributed evenly by the warm air in the oven.

- Select Start.

The steam will be released. It will take approximately 1 minute.

- Proceed as described to release further bursts of steam once Start is shown in green again.

Changing the function

You can change to another function during a cooking programme.

- Touch the symbol for the selected function.
- If you have set a cooking duration, confirm the **Cancel process?** message with **Yes**.
- Select the new function.

The new function appears in the display with its corresponding recommended values.

- Set the values for the cooking programme and confirm with **OK**.

General notes

This section contains general information. You will find more detailed information about particular foods and how to cook them in the other sections.

The advantages of cooking with steam

Almost all vitamins and minerals are retained as the food is not immersed in water.

Cooking with steam also retains the true taste of the food better than conventional cooking. We therefore recommend seasoning the food after it has been cooked. Food also retains its fresh, original colour.

Suitable containers

Cooking containers

Stainless steel cooking containers are provided with the steam oven. Other containers, in a variety of sizes, both perforated and solid, are available as optional extras (see “Optional accessories”). This enables you to choose the most suitable container for the meal you are preparing.

Use perforated cooking containers for **steam cooking** if possible. The steam can reach the food from all sides and the food is cooked evenly.

Your own containers

You can also use your own containers. However, please note the following:

- Containers must be suitable for use in an oven and able to withstand steam. With plastic containers, please check with the manufacturer that they are suitable for use in a steam oven.
- Thick-sided containers such as porcelain, ceramic or stoneware are not very suitable for using with steam. Due to their thick sides, they do not conduct heat well, meaning cooking durations will be considerably longer than those given in the charts.
- Place the containers on the rack or on a suitable tray. Depending on the size of the container, you can also place the rack on the floor of the oven compartment with the rack surface facing up and the cooking container on top. You can also take the side runners out to make more room (see “Cleaning the side runners” in the “Cleaning and care” chapter).
- Ensure that there is a gap between the upper rim of the container and the top of the oven compartment to allow sufficient steam into the container.

Shelf level

You can select any shelf level. You can also cook on several levels at the same time. This will not alter the cooking duration.

When using more than one deep container at the same time for steam cooking it is best to offset them on their runners and to leave at least one level free in between them.

Always insert cooking containers, the rack and the tray between the rails of the side runners so that they cannot tip.

Frozen food

The heating up phase for frozen food is longer than for fresh food. The greater the quantity of frozen food, the longer the heating up phase.

Temperature

During steam cooking, the temperature does not exceed 100 °C. Almost all foods can be cooked at this temperature. Some types of food, such as berries, need to be cooked at lower temperatures to prevent them from bursting. See the relevant sections in these operating instructions for more details.

Cooking duration

During steam cooking, the cooking duration does not begin until the set temperature is reached.

In general, the cooking durations for cooking with steam are the same as for cooking food in a saucepan. More information about any factors which may affect the cooking duration is given in the relevant sections.

The quantity of food does not affect the cooking duration. 1 kg of potatoes will take the same time to cook as 500 g.

Cooking with liquid

When cooking with liquid only fill the cooking container $\frac{2}{3}$ full to prevent the liquid spilling when the cooking container is removed from the oven.

Your own recipes - steam cooking

Food and recipes which are prepared in pot or a pan can also be cooked in the steam oven. The cooking times in the steam oven will be the same. Please note that food will not be brown or crisp when cooking with steam.

General notes

Universal tray and combi rack

Use the universal tray with the combi rack placed on top of it, e.g. for roasting and grilling. During roasting, you can use the meat juices collected in the tray to make a gravy or sauce.

If you are using the universal tray with the combi rack on top, insert the universal tray between the rails of a shelf level and the combi rack will automatically slide in above them. When removing them from the oven, pull both out together.

Non-tip safety notches

The combi rack and universal tray have non-tip safety notches which prevent them being pulled right out when they only need to be partially pulled out. The tray and rack can then only be taken out of the oven by raising them upwards and then pulling them out.

Eco Steam cooking

You can use the Eco Steam cooking  function to save energy during steam cooking. This function is suitable mainly for cooking fish and vegetables.

We recommend following the cooking durations and temperatures from the tables specified in “Steam cooking”. You can cook for longer if necessary.

When cooking starchy foods such as potatoes, rice and pasta, the best function to use is Steam cooking .

Settings

Oven functions | Eco Steam cooking 

Notes on the cooking tables

Follow the instructions on cooking durations, temperatures and cooking notes.

Selecting the cooking duration

The cooking durations given are guidelines only.

- We recommend selecting the shorter duration initially. You can cook for longer if necessary.

Steam cooking

Vegetables

Fresh

Prepare fresh vegetables in the usual way, i.e. wash, clean and cut them up.

Frozen food

Frozen vegetables do not need to be defrosted beforehand, unless they have been frozen together in a block.

Frozen and fresh vegetables which take the same length of time to cook can be cooked together.

If vegetables have frozen together in clumps, break these up before cooking with steam. Follow the manufacturer's instructions on the packaging regarding cooking duration.

Cooking containers

Food such as peas or asparagus spears, which have little or no space between them, will take longer to cook because the steam has less space to work in. For an even result, it is best to use a shallow container for these types of food, and only fill it about 3-5 cm deep. When cooking large quantities divide the food between 2 or 3 shallow containers rather than using one deep one.

Different types of vegetables which take the same length of time to cook can be cooked together.

Use solid containers for vegetables which are cooked in liquid.

Shelf level

To avoid any colour transfer when cooking vegetables with a distinctive colour (e.g. beetroot) in a perforated container, do not place other food underneath the perforated container.

Cooking duration

The cooking duration depends on the size of the food and how well cooked you want it, just as it does with conventional cooking methods. Example:

Waxy potatoes, cut into quarters:
approx. 17 minutes

Waxy potatoes, cut in half:
approx. 20 minutes

Settings

Automatic programmes  | Vegetables
| ... |

or

Oven functions  | Steam cooking 

Temperature: 100 °C

Cooking duration: see table

Steam cooking

Vegetables	 [min]
Artichokes	32–38
Cauliflower, whole	27–28
Cauliflower, florets	8
Beans, green	10–12
Broccoli, florets	3–4
Chantenay carrots, whole	7–8
Chantenay carrots, halved	6–7
Chantenay carrots, chopped	4
Chicory, halved	4–5
Chinese cabbage, chopped	3
Peas	3
Fennel, halved	10–12
Fennel, sliced	4–5
Kale, chopped	23–26
Waxy potatoes, peeled	
whole	27–29
halved	21–22
quartered	16–18
Mainly waxy potatoes, peeled	
whole	25–27
halved	19–21
quartered	17–18
Floury potatoes, peeled	
whole	26–28
halved	19–20
quartered	15–16
Kohlrabi, cut into batons	6–7
Pumpkin, diced	2–4
Corn on the cob	30–35
Chard, chopped	2–3

Steam cooking

Vegetables	 [min]
Peppers, diced or sliced	2
New potatoes, firm	30–32
Mushrooms	2
Leeks, sliced	4–5
Leeks, halved lengthways	6
Romanesco, whole	22–25
Romanesco, florets	5–7
Brussels sprouts	10–12
Beetroot, whole	53–57
Red cabbage, chopped	23–26
Black salsify, whole	9–10
Celeriac, cut into batons	6–7
Asparagus, green	7
Asparagus, white, whole	9–10
Carrots, chopped	6
Spinach	1–2
Spring cabbage, chopped	10–11
Celery, chopped	4–5
Swede, chopped	6–7
White cabbage, chopped	12
Savoy cabbage, chopped	10–11
Courgettes, sliced	2–3
Sugar snap peas	5–7

 Cooking duration

Fish

Fresh

Prepare fresh fish in the usual way, i.e. clean, gut and fillet.

Frozen food

Fish does not need to be fully defrosted before cooking. Defrost so that the surface is sufficiently thawed to take herbs and seasoning. Depending on the thickness of the fish, 2 - 5 minutes should be enough.

Preparation

Add some lemon or lime juice to fish before cooking. The citric acid helps the flesh stay firm.

It is not necessary to season fish with salt when cooking with steam as this method retains the minerals which give the fish its unique flavour.

Cooking containers

If using a perforated container, grease it first.

Shelf level

When cooking fish in a perforated container at the same time as cooking other types of food in other containers, place the container with the fish directly above the universal tray to catch any liquid and so avoid any transfer of tastes to other food.

Temperature

85 °C – 90 °C

For gently cooking delicate types of fish, such as sole.

100 °C

For cooking firmer types of fish, e.g. cod and salmon.
Also for cooking fish in sauce or stock.

Duration

The cooking duration depends on the thickness and the texture of the fish, and not on the weight. The thicker the fish, the longer the cooking duration. A 3 cm thick piece of fish weighing 500 g will take longer to cook than a 2 cm thick piece of fish weighing 500 g.

The longer fish cooks, the firmer its flesh will become. Use the cooking durations given in the chart. If you find that the fish is not cooked sufficiently only cook it for a few minutes more.

When cooking fish in sauce or stock, we recommend that you increase the cooking duration quoted by a few minutes.

Steam cooking

Tips

- Adding herbs and spices, such as dill, will help bring out the full flavour of the fish.
- Cook large fish in swimming position. To help maintain the shape of the fish, place a small cup or similar upside down in the cooking container, and arrange the fish belly-side down over the cup.
- You can use any fish scraps, e.g. fish heads, bones, tails etc to make a **fish stock**. Place the fish scraps together with some mixed vegetables in a solid cooking container and add cold water. Cook at 100 °C for 60 to 90 minutes. The longer the cooking duration, the stronger the stock.
- Preparing fish **au bleu** is a method involving cooking the fish in water with vinegar, at different proportions depending on the recipe. It is important not to damage the skin of the fish. This method is suitable for cooking carp, trout, tench, eel and salmon.

Settings

Automatic programmes Auto | Fish | ... |
Steam cooking

or

Oven functions | Steam cooking

Temperature: see table

Cooking duration: see table

Steam cooking

Fish	🌡️ [°C]	🕒 [min]
Eel	100	5–7
Perch fillet	100	8–10
Seabream fillet	85	3
Trout, 250 g	90	10–13
Halibut fillet	85	4–6
Cod fillet	100	6
Carp, 1.5 kg	100	18–25
Salmon fillet	100	6–8
Salmon steak	100	8–10
Salmon trout	90	14–17
Basa fillet	85	3
Rosefish fillet	100	6–8
Haddock fillet	100	4–6
Plaice fillet	85	4–5
Monkfish fillet	85	8–10
Sole fillet	85	3
Turbot fillet	85	5–8
Tuna fillet	85	5–10
Pike perch fillet	85	4

🌡️ Temperature 🕒 Duration

Steam cooking

Meat

Fresh

Prepare the meat in the usual way.

Frozen food

Meat should be thoroughly defrosted before cooking in the steam oven (see “Special applications” – “Defrost”).

Preparation

For meat which needs to be seared before being cooked, e.g. for a stew, sear the meat in a pan on the hob first.

Duration

The cooking duration depends on the thickness and the texture of the meat, and not on the weight. The thicker the piece of meat, the longer the cooking duration. A piece of meat weighing 500 g which is 10 cm thick will take longer to cook than a piece of meat weighing 500 g which is 5 cm thick.

Tips

- To retain the **flavour**, use a perforated cooking container. Place a solid cooking container or the universal tray underneath in order to collect the concentrate. You can use the concentrate to enhance your sauces or freeze it for later use.
- Boiling meat from chicken and beef as well as meat bones can be used to make a **strong stock**. Place the meat together with the bones and some mixed vegetables in a cooking container and add cold water. The longer the cooking duration, the stronger the stock.

Settings

Automatic programmes Auto | Meat | ... |
Steam cooking

or

Oven functions | Steam cooking

Temperature: 100 °C

Cooking duration: see table

Steam cooking

Meat	🕒 [min]
Leg steak, covered with water	110–120
Pork knuckle	135–140
Chicken breast	8–10
Hock	105–115
Top rib, covered with water	110–120
Veal strips	3–4
Gammon slices	6–8
Lamb stew	12–16
Poularde	60–70
Turkey roulades	12–15
Turkey escalopes	4–6
Short rib, covered with water	130–140
Beef goulash	105–115
Whole chicken, covered with water	80–90
Topside	110–120

🕒 Cooking duration

Steam cooking

Rice

Rice swells when cooked and needs to be cooked in liquid. The proportion of rice to liquid will vary depending on the type of rice.

The rice absorbs all the liquid during the cooking process and so none of the nutrients are lost.

Settings

Automatic programmes Auto | Rice | ... |

or

Oven functions | Steam cooking

Temperature: 100 °C

Cooking duration: see table

	Ratio Rice : Liquid	🕒 [min]
Basmati rice	1 : 1.5	15
Parboiled rice	1 : 1.5	23–25
Round grain rice		
Pudding rice	1 : 2.5	30
Risotto rice	1 : 2.5	18–19
Brown rice	1 : 1.5	26–29
Wild rice	1 : 1.5	26–29

🕒 Duration

Grain

Grain swells during cooking and needs to be cooked in liquid. The proportion of grain to liquid depends on the type of grain.

Grain can be cooked whole or cracked.

Settings

Automatic programmes Auto | Grain | ... |

or

Oven functions | Steam cooking

Temperature: 100 °C

Cooking duration: see table

	Ratio Grain : Liquid	🕒 [min]
Amaranth	1 : 1.5	15–17
Bulgur	1 : 1.5	9
Green spelt, whole	1 : 1	18–20
Green spelt, cracked	1 : 1	7
Oats, whole	1 : 1	18
Oats, cracked	1 : 1	7
Millet	1 : 1.5	10
Polenta	1 : 3	10
Quinoa	1 : 1.5	15
Rye, whole	1 : 1	35
Rye, cracked	1 : 1	10
Wheat, whole	1 : 1	30
Wheat, cracked	1 : 1	8

🕒 Duration

Steam cooking

Pasta

Dry pasta

Dry pasta swells when it is cooked and needs to be cooked in liquid. The liquid must cover the pasta. Using hot liquid gives better results.

Increase the cooking time stated by the manufacturer by approx. $\frac{1}{3}$.

Fresh food

Fresh pasta, such as the kind you can buy from the supermarket chilled counter, does not need to absorb water. Cook fresh pasta in a greased perforated container.

Separate any pieces of pasta which have stuck together and spread them out in the cooking container.

Settings

Automatic programmes Auto | Pasta | ... |

or

Oven functions | Steam cooking

Temperature: 100 °C

Cooking duration: see table

Fresh	🕒 [min]
Gnocchi	2
Knöpfli	1
Ravioli	2
Spätzle	1
Tortellini	2
Dry pasta, covered with water	
Tagliatelli	14
Vermicelli	8

🕒 Duration

Dumplings

Ready made boil-in-the-bag dumplings need to be well covered with water as otherwise they can fall apart. This is because even though they have been soaked in water beforehand they will not absorb enough moisture.

Cook fresh dumplings in a greased, perforated container.

Settings

Automatic programmes Auto | Pasta | ... |

or

Oven functions | Steam cooking

Temperature: 100 °C

Cooking duration: see table

	🕒 [min]
Sweet dumplings	30
Yeast dumplings	20
Boil-in-the-bag potato dumplings	20
Boil-in-the-bag bread dumplings	18–20

🕒 Duration

Steam cooking

Dried pulses

Soak pulses for at least 10 hours in cold water before cooking. Soaking makes the pulses more digestible and shortens the cooking duration required. Soaked pulses must be covered with liquid during cooking.

Lentils do not need to be soaked before cooking.

With unsoaked pulses a certain ratio of pulses to liquid is required depending on variety.

Settings

Automatic programmes Auto | Pulses | ... |

or

Oven functions | Steam cooking

Temperature: 100 °C

Cooking duration: see table

Soaked	
	🕒 [min]
Beans	
Kidney beans	55–65
Adzuki beans	20–25
Black beans	55–60
Pinto beans	55–65
Haricot beans	34–36
Peas	
Yellow split peas	40–50
Green split peas	27

🕒 Duration

Steam cooking

Unsoaked		
	Ratio Pulses : Liquid	🕒 [min]
Beans		
Kidney beans	1 : 3	130–140
Adzuki beans	1 : 3	95–105
Black beans	1 : 3	100–120
Pinto beans	1 : 3	115–135
Haricot beans	1 : 3	80–90
Lentils		
Brown lentils	1 : 2	13–14
Red lentils	1 : 2	7
Peas		
Yellow split peas	1 : 3	110–130
Green split peas	1 : 3	60–70

🕒 Duration

Steam cooking

Hen's eggs

Use a perforated container to boil eggs in the steam oven.

The eggs do not need to be pierced before cooking as they are gradually warmed during the heating up phase and so do not burst when they are cooked with steam.

When using a solid container for making egg dishes such as scrambled eggs, remember to grease it first.

Settings

Automatic programmes Auto | Hen's eggs | ... |

or

Oven functions | Steam cooking

Temperature: 100 °C

Cooking duration: see table

	 [min]
Small soft medium hard	 3 5 9
Medium soft medium hard	 4 6 10
Large soft medium hard	 5 6-7 12
Extra large soft medium hard	 6 8 13

 Duration

Fruit

Cook fruit in a solid container so that none of the juice is lost. If you wish to cook fruit in a perforated container, place a solid container directly underneath it to collect the juice.

Tip: You can use the juice which has collected in the solid container to make a glaze for a fruit flan.

Settings

Automatic programmes Auto | Fruit | ... |

or

Oven functions | Steam cooking

Temperature: 100 °C

Cooking duration: see table

	🕒 [min]
Apple chunks	1–3
Pear chunks	1–3
Cherries	2–4
Mirabelle plums	1–2
Nectarine/peach chunks	1–2
Plums	1–3
Quinces, diced	6–8
Rhubarb chunks	1–2
Gooseberries	2–3

🕒 Cooking duration

Sausages

Settings

Automatic programmes Auto | Sausages

| ... |

or

Oven functions | Steam cooking

Temperature: 90 °C

Cooking duration: see table

Sausages	🕒 [min]
Frankfurters	6–8
Bologna sausages	6–8
Veal sausages	6–8

🕒 Duration

Steam cooking

Shellfish

Preparation

Defrost frozen shellfish before cooking with steam.

Peel, remove and discard the intestines, and then wash the shellfish.

Cooking containers

If using a perforated container, grease it first.

Duration

The longer shellfish are cooked, the tougher they become. Use the cooking durations given in the chart.

When cooking shellfish in sauce or stock, we recommend that you increase the cooking duration quoted by a few minutes.

Settings



Automatic programmes  | Shellfish | ... |

or

Oven functions  | Steam cooking 

Temperature: see table

Cooking duration: see table

	 [°C]	 [min]
Crevettes	90	3
Prawns	90	3
King prawns	90	4
Small shrimps	90	3
Lobster	95	10–15
Large shrimps	90	3

 Temperature  Duration

Mussels

Fresh food

 Danger of food poisoning from spoiled mussels.
Spoiled mussels can cause food poisoning.
Only cook mussels which are closed.
Do not eat mussels which have not opened after being cooked.

Steep fresh mussels in water for a few hours before cooking to rinse out any sand. Then scrub the mussels thoroughly to clean them.

Frozen food

Defrost frozen mussels before cooking.

Duration

The longer mussels are cooked, the tougher they become. Use the cooking durations given in the chart.

Settings



Automatic programmes Auto | Mussels and clams | ... |

or

Oven functions | Steam cooking

Temperature: see table

Cooking duration: see table

	 [°C]	 [min]
Barnacles	100	2
Cockles	100	2
Mussels	90	12
Scallops	90	5
Razor clams	100	2–4
Venus clams	90	4

 Temperature  Duration

Steam cooking

Menu cooking (cooking whole meals) - manually

Before cooking meals with the manual menu cooking function, switch off steam reduction (see “Settings – Steam reduction”).

When cooking a menu, you can combine different foods with different cooking durations, e.g. fish fillet with rice and broccoli.

The food is placed in the steam oven compartment at different times so that each item is ready at the same time.

Shelf level

Place foods that produce a lot of liquid (e.g. fish) or have a distinctive colour (e.g. beetroot) directly above universal tray. This avoids any transfer of flavour or colour to other food and prevents liquid dripping onto food below it.

Temperature

Whole meals should be cooked at a temperature of 100 °C as this is the temperature required to cook the majority of foods.

Do not cook a whole meal at the lowest temperature when different temperatures are required for different types of food, e.g. 85 °C for seabream and 100 °C for potatoes.

If the recommended cooking temperature for the food is 85 °C for example, try cooking it at 100 °C and testing the result. Some delicate types of fish with a soft structure, e.g. sole and plaice will become very firm when cooked at 100 °C.

Duration

If you are increasing the recommended temperature, shorten the cooking duration by approx. $\frac{1}{3}$.

Example

Food cooking durations

(see cooking tables in “Steam cooking”)

Parboiled rice	24 minutes
Rosefish fillet	6 minutes
Broccoli	4 minutes

Calculation of set cooking durations:

24 minutes minus

6 minutes = 18 minutes (1st cooking duration: rice)

6 minutes minus 4 minutes = 2 minutes (2nd cooking duration: rosefish fillet)

Remaining time = 4 minutes (3rd cooking duration: broccoli)

Cooking duration	24 min. – rice		
		6 min. – fish fillet	
			4 min. – broccoli
Settings	18 min.	2 min.	4 min.

Cooking a whole menu

- Place the rice in the oven compartment first.
- Set the 1st cooking duration: 18 minutes.
- After the 18 minutes, place the fish into the appliance.
- Set the 2nd cooking duration: 2 minutes.
- After the 2 minutes, place the broccoli into the appliance.
- Set the 3rd cooking duration: 4 minutes.

Sous-vide (vacuum) cooking

With this gentle cooking method, food is cooked slowly and at a low, constant temperature in vacuum packaging.

With vacuum cooking, no moisture evaporates during cooking and all nutrients and flavours are retained.

The cooking result has an intensive taste and food is cooked evenly.

Use only fresh food which is in a good condition.

Ensure hygienic conditions and that food has not been out of the refrigerator too long, e.g. during transportation.

Use only heat-stable, boiling-resistant vacuum sealing bags.

Do not cook food in the sales packaging, such as vacuum-packed frozen food as it is possible that the packaging used is not suitable for vacuum cooking.

Do not use the vacuum sealing bag more than once.

Vacuum-seal the food in a chamber system vacuum sealer only.

Important usage notes

For best cooking results, follow the instructions below:

- Use herbs and spices more sparingly than with conventional cooking methods because the impact on the taste of the food will be stronger. You can also cook the food unseasoned and add seasoning after cooking.
 - The cooking duration is reduced when salt, sugar and liquids are added.
 - The food becomes firmer if acidic ingredients such as lemon or vinegar are added.
 - Do not use alcohol or garlic as this can produce unpleasant flavours.
 - Only use vacuum sealing bags that match the size of the food. If the vacuum sealing bag is too big, too much air can remain inside.
 - If you want to cook several items of food in one vacuum sealing bag, put them side-by-side in the bag.
 - If you want to cook food in several vacuum sealing bags at once, put the bags side-by-side on the rack.
 - The cooking durations depend on the thickness of the food.
 - With high temperatures and/or long cooking durations, the appliance may run low on water. Check the display from time to time.
- Keep the door closed during the cooking programme. Opening the door will prolong the cooking process and can change the cooking result.
 - Temperatures and cooking durations from sous-vide recipes cannot always be emulated exactly. Alter the settings to achieve the degree of cooking you want.

Sous-vide (vacuum) cooking

Tips

- In order to reduce cooking times, you can vacuum-seal food items 1–2 days before the cooking programme. Store the vacuum-sealed food in the refrigerator at no more than 5 °C. In order to preserve quality and flavour, the food should be cooked no later than 2 days afterwards.

- Freeze liquids such as marinades before vacuum-sealing to prevent them from escaping from the bag.

- Fold the edges of the vacuum sealing bag outwards for filling. This will give you clean, perfect seams.

- If you do not want to eat the food straight after cooking, put it in iced water immediately and allow it to cool down completely. After this, store the food at temperatures no greater than 5 °C.

This way, you can retain the food's quality and flavour while keeping it fresh for longer.

Exception: Poultry must be eaten straight after the cooking programme.

- After cooking, cut the vacuum sealing bag on all sides for easier access to the food.

- Briefly fry meat and firm types of fish (such as salmon) before serving for a roasted aroma.

- Use the stock or marinade of vegetables, fish or meat to make a sauce.

- Serve the food on pre-warmed plates.

Sous-vide (vacuum) cooking

Using the Sous-vide function

- Rinse the food with cold water and dry it.
- Place the food in a vacuum sealing bag and add spices or liquid if desired.
- Vacuum-seal the food in a chamber system vacuum sealer.
- For the best cooking results, place the rack on shelf level 2.
- Place the vacuum-sealed food on the rack (next to each other if there are several bags).
- Select Oven functions .
- Select Sous-vide .
- Change the recommended temperature if necessary.
- Confirm with *OK*.
- Set further settings as necessary (see “Operation”).

Possible reasons for unsatisfactory results

The bag has opened:

- The seal was not clean or strong enough and has opened.
- The bag was damaged by a sharp bone.

The food has an unpleasant or strange taste:

- Incorrect storage of the food; the food was kept out of the refrigerator for too long.
- The food was contaminated with bacteria before it was vacuum sealed.
- Too much of ingredients such as spices was added.
- The bag or seal was not in perfect order.
- The vacuum was insufficient.
- The food was not eaten or chilled immediately after cooking.

Sous-vide (vacuum) cooking

The cooking durations given in the tables are guidelines only. We recommend selecting the shorter duration initially. You can cook for longer if necessary. The cooking duration only begins when the set temperature is reached.

Food	Added in advance		🌡️ [°C]	⌚ [min]
	Sugar	Salt		
Fish				
Atlantic cod fillet, 2.5 cm thick		x	54	35
Salmon fillet, 2–3 cm thick		x	52	30
Monkfish fillet		x	62	18
Pikeperch fillet, 2 cm thick		x	55	30
Vegetables				
Cauliflower florets, medium to large		x	85	40
Hokkaido pumpkin, sliced		x	85	15
Kohlrabi, sliced		x	85	30
Asparagus, white, whole	x	x	85	22–27
Sweet potato, sliced		x	85	18
Fruit				
Pineapple, sliced	x		85	75
Apples, sliced	x		80	20
Baby bananas, whole			62	10
Peaches, halved	x		62	25–30
Rhubarb chunks			75	13
Plums, halved	x		70	10–12
Other				
Beans, white, soaked in a ratio of 1:2 (beans to liquid)		x	90	240
Prawns, peeled and deveined		x	56	19–21
Hen's egg, whole			65–66	60
Scallops, removed from shell			52	25
Shallots, whole	x	x	85	45–60

🌡️ Temperature ⌚ Duration

Sous-vide (vacuum) cooking

Food	Added in advance		🌡️ [°C]		🕒 [min]
	Sugar	Salt	Medium*	Done*	
Meat					
Duck breast, whole		x	66	72	35
Saddle of lamb			58	62	50
Beef fillet steak, 4 cm thick			56	61	120
Beef rump steak, 2.5 cm thick			56	–	120
Pork tenderloin, whole		x	63	67	60

🌡️ Temperature 🕒 Duration

* Degree of cooking

The “well done” cooking degree uses a higher core temperature than “medium”, but results are not the same as being well-done in the traditional sense.

Sous-vide (vacuum) cooking

Reheating

Only reheat brassicas, such as kohlrabi and cauliflower, in combination with a sauce. Without sauce, an unpleasant cabbage-like taste and grey-brown colour may develop.

Food with a short cooking duration or which continues cooking during reheating, such as fish, is not suitable for reheating.

Preparation

Place the cooked food into ice water for approx. 1 hour directly after cooking. The rapid cooling prevents the food from continuing to cook, which helps retain the optimum cooked condition. Then store the food in the refrigerator at a maximum temperature of 5 °C.

Please note that the quality of the food decreases the longer it is stored.

We recommend that you do not store the food in the refrigerator for longer than 5 days before reheating.

Settings

Oven functions | Sous-vide 

Temperature: see table

Duration: see table

Sous-vide (vacuum) cooking

Reheating with the Sous-vide function

The durations specified in the table are guidelines only. You can increase the duration if necessary. The cooking duration only begins when the set temperature is reached.

Food	🌡️ [°C]		🕒 ² [min]
	Medium ¹	Done ¹	
Meat			
Saddle of lamb	58	62	30
Beef fillet steak, 4 cm thick	56	61	30
Beef rump steak, 2.5 cm thick	56	–	30
Pork tenderloin, whole	63	67	30
Vegetables			
Cauliflower florets, medium to large ³	85		15
Kohlrabi, sliced ³	85		10
Fruit			
Pineapple, sliced	85		10
Other			
Beans, white, soaked in a ratio of 1:2 (beans to liquid)	90		10
Shallots, whole	85		10

🌡️ Temperature, 🕒 Time

1 Degree of cooking

The “well done” cooking degree uses a higher core temperature than “medium”, but results are not the same as being well-done in the traditional sense.

2 Durations apply to vacuum-sealed food with an initial temperature of approx. 5 °C (refrigerator temperature).

3 Reheat only in sauce.

Special applications

Reheat

To reheat food which was cooked using the sous-vide method, use the Sous-vide  function (see “Sous-vide – Reheating”).

The steam oven is very effective at reheating food gently, without drying it out or cooking it further. The food will reheat evenly and does not need to be stirred during the reheating process.

You can reheat individual dishes or plated meals which have been prepared previously (e.g. meat, vegetables and potatoes).

Suitable containers

Small quantities can be reheated on a plate, larger quantities should be placed in a cooking container.

Time

10–12 minutes are usually sufficient for one plate of food. More than one plate will need a little longer.

If you are reheating several plated meals one after the other, the reheating time can be reduced by around 5 minutes for the second and subsequent plates as the oven compartment will still be hot.

Moisture

The more moist the food, the less moisture needs to be added.

Tips

- Do not reheat large items, such as a joint of roast meat, whole. Divide it into portions and reheat these as plated meals.
- Compact items, such as stuffed peppers or roulades, should be cut in half.
- Reheat sauces separately. Exceptions are dishes such as goulash, which is cooked in sauce.
- Please note that breaded items, such as schnitzel, will not retain their crispness when they are reheated.

Food does not need to be covered before it is reheated.

Settings

Special applications  | Reheat or

Oven functions  | Combi mode  | Combi Fan plus 

Temperature: see chart

Moisture: see chart

Duration: see chart

Special applications

The durations specified in the chart are guidelines only. We recommend selecting the shorter duration initially. You can make the duration longer if necessary.

Food	🌡️ [°C]	💧 [%]	⌚* [min]
Vegetables			
Carrots Cauliflower Kohlrabi Beans	120	70	8–10
Side dishes			
Pasta Rice Potatoes, cut in half lengthways	120	70	8–10
Dumplings Mashed potato	140	70	18–20
Meat and poultry			
Sliced meat, 1.5 cm thick Roulades, sliced Goulash Lamb stew Meatballs Chicken escalopes Turkey escalopes, sliced	140	70	11–13
Fish			
Fish fillet Fish roulade, halved	140	70	10–12
Plated meals			
Spaghetti, in tomato sauce Pork roast, potatoes and vegetables Stuffed peppers (cut in half), rice Chicken fricassee, rice Vegetable soup Creamed soup Clear broth Stew	120	70	10–12

🌡️ Temperature, 💧 Moisture, ⌚ Duration

* These times apply to food heated on a plate.

Special applications

Defrost

It is much quicker to defrost food in the steam oven than at room temperature.

 Risk of infection from bacteria. Bacteria such as salmonella can cause life-threatening food poisoning.

It is particularly important to observe food hygiene rules when defrosting fish and meat, and in particular when defrosting poultry.

Do not use the liquid produced during defrosting.

Process the food as required as soon as it has been defrosted.

Temperature

60 °C is the best temperature for defrosting.

Exception: 50 °C for minced meat and game

Before and after defrosting

Remove any packaging before defrosting.

Exceptions: Leave bread, biscuits and cakes in their packaging as otherwise they will absorb moisture and become soft.

Allow food to stand at room temperature for a few minutes after defrosting. The standing time is necessary to allow the even distribution of heat from the outside to the inside.

Cooking containers

Use a perforated container with the universal tray underneath when defrosting food which will drip, such as poultry. This way food will not be lying in defrosted liquid.

Food which does not drip can be defrosted in a solid container.

Tips

- Fish, for instance, does not need to be fully defrosted before cooking. Defrost so that the surface is sufficiently thawed to take herbs and seasoning. Depending on the thickness of the fish, 2–5 minutes is generally enough.
- When defrosting food which has frozen together, e.g. berries and meat portions, separate them half-way through the defrosting time.
- Do not refreeze food once it has thawed.
- Defrost frozen pre-cooked meals according to the instructions on the packaging.

Settings

Special applications  | Defrost or

Oven functions  | Steam cooking 

Temperature: see chart

Defrosting time: see chart

Standing time: see chart

Special applications

The durations specified in the table are guidelines only. We recommend selecting the shorter defrosting time initially. You can increase the defrosting time longer if necessary.

Frozen food	Quantity	🌡️ [°C]	🕒 [min]	⌚ [min]
Dairy products				
Sliced cheese	125 g	60	15	10
Quark	250 g	60	20–25	10–15
Cream	250 g	60	20–25	10–15
Soft cheese	100 g	60	15	10–15
Fruit				
Apple sauce	250 g	60	20–25	10–15
Apple chunks	250 g	60	20–25	10–15
Apricots	500 g	60	25–28	15–20
Strawberries	300 g	60	8–10	10–12
Raspberries/currants	300 g	60	8	10–12
Cherries	150 g	60	15	10–15
Peaches	500 g	60	25–28	15–20
Plums	250 g	60	20–25	10–15
Gooseberries	250 g	60	20–22	10–15
Vegetables				
Frozen in a block	300 g	60	20–25	10–15
Fish				
Fish fillets	400 g	60	15	10–15
Trout	500 g	60	15–18	10–15
Lobster	300 g	60	25–30	10–15
Small shrimps	300 g	60	4–6	5
Ready meals				
Meat, vegetables, side dishes/ stew/soup	480 g	60	20–25	10–15
Meat				
Roast meat, sliced	125–150 g each	60	8–10	15–20

Special applications

Frozen food	Quantity	🌡️ [°C]	🕒 [min]	⌚ [min]
Minced meat	250 g	50	15–20	10–15
	500 g	50	20–30	10–15
Goulash	500 g	60	30–40	10–15
	1000 g	60	50–60	10–15
Liver	250 g	60	20–25	10–15
Saddle of hare	500 g	50	30–40	10–15
Saddle of venison	1000 g	50	40–50	10–15
Cutlets/chops/sausages	800 g	60	25–35	15–20
Poultry				
Chicken	1000 g	60	40	15–20
Chicken thighs	150 g	60	20–25	10–15
Chicken escalopes	500 g	60	25–30	10–15
Turkey legs	500 g	60	40–45	10–15
Baked goods				
Puff pastries/yeast-dough pastry	–	60	10–12	10–15
Creamed mixture cakes/biscuits	400 g	60	15	10–15
Bread/rolls				
Bread rolls	–	60	30	2
Rye bread, sliced	250 g	60	40	15
Wholegrain bread, sliced	250 g	60	65	15
White bread, sliced	150 g	60	30	20

🌡️ Temperature 🕒 Defrosting time ⌚ Standing time

Mix & Match

The Mix & Match special application is available to help with simple and uncomplicated preparation of plated meals. With this application, you can re-heat food that has already been cooked (convenience food) or assemble a portioned-out meal using fresh food and cook it on a plate.

During cooking, you have the choice between a crispy, browned result or gently cooked food with a succulent surface without additional browning.

Only use food that is completely hygienic. If you have any concerns, dispose of the food.

Containers

Use:

- a flat plate or a small ovenproof dish
- a deep bowl or a cup for food that requires liquid to be added

Baked goods, pizza, flammkuchen, etc. can be placed directly on the rack (with baking parchment if necessary).

The plastic containers for ready meals are not sufficiently heat-resistant.

Transfer ready meals into suitable cooking containers.

Special applications

Tips for reheating plated meals

- For fried or gratin dishes, use **Crispy reheating** and for baked or boiled dishes, use **Gentle reheating**.
- Using **Crispy reheating** ensures that only food that was crispy before reheating stays crispy.
- The food should not exceed a height of 2–2.5 cm. Transfer taller food into flat containers (e.g. stew) or slice it into smaller pieces (e.g. roulades, bakes).
- Only reheat pasta mixed into a sauce.
- Droplets of water may have accumulated underneath the crockery. Dry the droplets of water before serving.

Tips for cooking plated meals

- You can easily make a sauce from the meat and fish stock: add 1 tsp of cornflour to the raw meat or fish before cooking. Stir the sauce with a fork until smooth before serving. You can also use 1 tsp of mashed potato powder (instant) or a pinch of guar gum instead of cornflour.
- If cooking durations for different foods are not the same, you can compensate for this by changing the size of the food: if the cooking duration is shorter, make the pieces larger (e.g. large cauliflower florets). If the cooking duration is longer, make the pieces smaller (e.g. diced potatoes).
- You can also compensate for differing cooking durations with layering: place food with a short cooking duration under a food with a long cooking duration or put them together as a small bake.
- To prevent the food from drying out, prepare your dish with a sauce or marinade. You can also use cheese or bacon.

Assembling a plated meal using various components

For a good cooking result, you must put together the individual components of the dish – such as meat, side dishes and vegetables – so that a common setting can be selected for browning. This setting must be suitable for all elements of the meal, or at least conditionally suitable.

We recommend using the following procedure:

- Select a main ingredient based on the cooking charts, e.g. steak.
- Select other ingredients which have the corresponding settings for browning, e.g. green beans and rice.

Notes on the cooking charts

As well as information on portion sizes or the way the food needs to be processed prior to cooking, the cooking charts also provide tips on preparation.

The degree of browning is represented in the display by a bar with seven segments. Basically, the more segments that are filled, the longer the cooking duration.

You can use the icons to determine which setting is appropriate to brown the food:

Symbol	Meaning
—	Unsuitable
□	Conditionally suitable
■	Suitable

Special applications

Using the Mix & Match special application

Food does not need to be covered while it is being cooked.

- Prepare the food as required.
- Select Special applications | Mix & Match.
- If you are preparing food that is already **cooked**, select Gentle reheating or Crispy reheating.
- If you are preparing food that is **fresh** or just partially cooked, select Gentle cooking or Crispy cooking.
- Change the setting for browning if necessary.
- Confirm with *OK*.
- Place the food on the rack on shelf level 2.
- Confirm with *OK*.

You can start the cooking programme immediately or delay the start.

- If by the end of a cooking programme, the plated meal is not cooked enough for your taste, select Continue cooking.

Reheat food with the “Crispy reheating” special application

Food	Browning segment bar setting
Apple strudel, 4 cm thick	___ _ _ _ □ ■ □ _ _
Baked camembert, 25 g	___ _ _ _ ■ □ _ _ _
Baked camembert, 75 g	___ _ _ _ □ ■ □ _ _
Baguettes, pre-baked	_ □ ■ □ _ _ _ _
Puff pastry canapés	_ □ ■ □ □ _ _ _
Puff pastry pockets, filled with spinach	_ □ ■ □ _ _ _ _
Börek pastry, 3 cm thick	___ _ _ □ □ ■ □
Fried potatoes (convenience)	___ _ □ ■ □ _ _ _
Patty ¹ , tofu	_ □ □ ■ □ _ _ _
Bread roll (wheat), pre-baked	___ _ □ ■ □ _ _ _
Bread roll (rye), pre-baked	___ _ _ □ ■ _ _ _
Bread roll, stale, soft	___ _ _ □ ■ _ _ _
Cheeseburger	___ _ □ ■ _ _ _ _
Chilli con carne ¹ , 2 cm deep	___ _ _ □ ■ □ _ _
Ciabatta rolls, pre-baked	___ _ _ ■ □ _ _ _
Ciabatta rolls, stale, soft	___ _ _ ■ □ _ _ _
Crêpe ¹	___ _ □ □ _ _ _ _
Flammkuchen (convenience)	_ □ ■ □ _ _ _ _
Flammkuchen, ready-made dough with own toppings	_ □ □ ■ _ _ _ _
Meat strips ¹ (convenience)	□ □ ■ □ □ _ _ _
Focaccia, pre-baked, 3–4 cm thick	□ □ □ ■ □ _ _ _
Meat patty ¹ (pork), 25 g	□ □ ■ □ □ □ □ _
Meat patty ¹ (pork), 60 g	___ _ _ □ ■ □ _ _
Meat patty ¹ (pork), 100 g	___ _ _ □ □ ■ □
Spring rolls, small	___ _ _ □ ■ □ _ _
Spring rolls	___ _ _ _ □ ■ □
Hot dog ¹	□ □ ■ □ _ _ _ _

Special applications

Food	Browning segment bar setting
Kaiserschmarrn pancake ¹ (convenience)	__ □ □ ■ □ □ __
Potatoes, fairly firm, sliced	__ __ □ ■ □ __ __
Potato pockets (convenience)	__ __ □ □ ■ □ __
Lasagne ¹ , 3 cm thick	__ _ _ ■ ■ ■ □ □
Naan ¹ , pre-baked	__ □ ■ □ __ _ _
Pasta, fresh with sauce, cheese	__ __ □ □ □ __
Pasta bake ¹ , 2 cm deep	__ _ _ ■ □ __
Pasta bake ¹ , 4.5 cm deep	__ _ _ □ ■ __
Pasta bake ¹ , 6 cm deep	__ _ _ _ □ ■
Pancakes ¹	■ □ _ _ _ _
Pancakes ¹ , rolled	__ __ □ ■ □ __
Pita ¹ , pre-baked	□ □ ■ □ _ _ _
Pizza (convenience)	□ □ ■ □ □ □ __
Poffertjes pancake	__ _ _ □ ■ □ __
Quiche, small	□ □ ■ □ _ _ _
Quiche, 2 cm deep	__ __ □ ■ □ __
Quiche, 3.5 cm deep	__ _ _ □ ■ □
Potato pancakes	__ _ _ ■ □ __
Hash browns (convenience)	__ __ □ ■ □ __
Escalope	__ __ □ ■ □ □ __
Taco shell	□ □ ■ □ □ □ __
Hawaii toast	__ □ ■ □ __ _ _
Cheese on toast	□ ■ _ _ _ _
Tortilla chips with cheese	__ □ ■ □ __
Tortilla ¹ (rolled in aluminium foil)	□ □ ■ □ □ __

¹ is not crispy, only needs to be sufficiently heated (> 65 °C).

Cooking food with the “Crispy cooking” special application

Food	Cooking tips	Browning segment bar setting
Meat¹		
Bratwurst (pork), boiled, 25 g	Cut	___ _ □ □ ■ □
Bratwurst (pork), boiled, 100 g	Cut	___ _ _ _ □ □ □
Bratwurst (pork), coarse	Brush with oil, cut	___ _ _ _ _ _ □ ■
Beef kebabs, large chunks	Marinated	□ ■ _ _ _ _ _ _
Pork kebabs, large chunks	Marinated	□ □ □ ■ □ _ _ _
Meat patty (pork), 60 g	–	___ _ _ _ □ ■ □
Chicken breast, 3 cm thick	With bacon, marinated	□ □ □ ■ □ _ _ _
Chicken breast, 3 cm thick	On its own, marinated	_ □ □ ■ _ _ _ _
Stuffed chicken breast	Filling: spinach, crème fraîche	_ □ □ ■ _ _ _ _
Chicken kebabs, large chunks	Marinated	□ □ ■ □ _ _ _ _
Chicken drumstick	Marinated	___ _ □ □ □ ■
Saddle of veal, 180 g	Marinated, with sauce	□ _ _ _ _ _ _ _
Gammon, 2.5–4 cm thick	–	___ _ □ ■ □ □ □
Gammon cutlet, 2 cm thick	–	___ □ □ ■ □ _ _ _
Lamb chop, 2 cm thick	Marinated	□ ■ □ □ _ _ _ _
Steak, 2.5–3.5 cm thick	Marinated	_ □ ■ □ _ _ _ _
Pork tenderloin, 4 cm thick	With bacon	□ □ ■ □ _ _ _ _
Pork chop	Breaded, drizzled with oil	___ _ _ _ _ □
Fish¹		
Halibut cutlet	Marinated	□ ■ _ _ _ _ _ _
Cod	With butter and breadcrumb crust	___ _ □ ■ □ _ _
Cod fillet, 3–3.5 cm thick	Marinated	■ □ □ _ _ _ _ _
Cod fillet roulade	Stuffed	■ □ _ _ _ _ _ _
Salmon fillet, 2.5–3 cm thick	Marinated	□ □ ■ □ □ _ _ _
Salmon cutlet	Marinated	□ □ ■ □ □ _ _ _
Salmon kebab, large chunks	Marinated	□ □ ■ □ □ _ _ _
Pollock fillet	Topping: spinach, feta	■ □ _ _ _ _ _ _

Special applications

Food	Cooking tips	Browning segment bar setting
Tuna	With tomatoes, topped with cheese	--- □ ---
Catfish kebab, large chunks	Marinated	--- □ □ □ ■ ---
Side dishes		
Fried potatoes (convenience), gently fried	–	--- □ □ □ ■
Dates in bacon (convenience)	–	--- □ □ ■ □ ---
Fresh pasta, tortellini	–	□ ---
Gnocchi (convenience)	With small chunks of butter or cheese	■ □ ---
Potatoes ² , slices/small cubes	Brush with oil	--- □ □ □ ■
Potato pockets (convenience), pre-cooked	–	■ □ ---
Lasagne, pre-cooked, 3 cm thick	–	□ □ ---
Brown rice, cooking duration 8 minutes	Salt, 1 : 2 (rice : liquid)	--- □ ■ ---
Pasta bake, fresh pasta	Raw meat, vegetables, sauce	--- □ □ ■ □ □ □
Pasta bake, pre-cooked, 2 cm deep	–	□ ---
Potato pancakes (convenience mixture)	Brush with oil	--- □ □ ---
Rice (convenience), pre-cooked	–	□ □ ■ □ ---
Hash browns (convenience), pre-cooked	–	■ □ ---
Potato dumplings (convenience)	With small chunks of butter	□ □ □ □ □ □ ---
Vegetables		
Aubergine, 2 cm thick	Oil, salt, pepper	--- □ □ ---
Cauliflower, large florets	Salt and pepper	□ ---
Broccoli, large florets	Sauce	□ ■ □ ---
Beans, green (string beans)	With bacon, salt, pepper	--- ■ □ ---
Cherry tomatoes, whole	Marinated	■ □ □ □ ---
Kohlrabi, thick slices	Marinated	□ □ □ □ ---
Squash, in small cubes	Salt and pepper	■ □ ---
Corn on the cob	Marinated	--- □ □ ■ □ ---

Special applications

Food	Cooking tips	Browning segment bar setting
Carrots, quartered/in thick slices	Salt and pepper	□□□□_ _ _ _
Pepper, large chunks	Marinated	□□□□■□_ _ _ _
Ratatouille, roughly chopped	Tomato purée, ketchup, seasoning, cornflour	□□_ _ _ _ _ _
Courgette, 2 cm thick	Oil, salt, pepper	_ _ _ _ □□_ _ _ _
Other		
Baked camembert, 25 g	–	■□_ _ _ _ _ _
Baguette, part-baked bread rolls	–	□■□_ _ _ _ _
Bread roll, stale, soft	–	□□_ _ _ _ _ _
Cheeseburger, pre-cooked	–	□□_ _ _ _ _ _
Flammkuchen (convenience)	–	_ _ _ _ □■_ _ _ _
Flammkuchen, ready-made dough with own toppings	–	_ _ □■□□_ _ _ _
Spring roll, frozen, 25 g	–	_ □■□□_ _ _ _
Spring roll, frozen, 100 g	–	_ □□□□_ _ _ _
Grilled cheese (convenience)	–	_ _ _ _ □■_ _ _ _
Kaiserschmarrn pancake (convenience)	–	_ _ _ □■□□_ _ _ _
Kaiserschmarrn pancake, uncooked	–	_ _ _ _ □□_ _ _ _
Tofu patty, pre-cooked	–	■□_ _ _ _ _ _
Onion tart (convenience)	–	_ _ _ _ □□_ _ _ _

¹ Add 1 tsp cornflour to raw meat/fish.

² Fairly firm

Special applications

Food suitable for the “Gentle cooking” special application

Food	Cooking tip
Meat¹	
Sausage (pork)	–
Beef kebabs, large chunks	Marinated with peanut sauce
Pork kebabs	Marinated
Chicken breast, 150 g, 3 cm thick	On its own
Stuffed chicken breast	Filling: spinach, crème fraîche
Chicken kebabs, large chunks	Marinated
Chicken fricassee	–
Saddle of veal, 180 g	In sauce
Gammon, 230 g, 2.5–4 cm thick	Salt and pepper
Gammon cutlet (pork), 200 g, 2 cm thick	Salt and pepper
Meatballs (pork), 50–100 g each	In sauce
Fish¹	
Trout, whole, without head	Seasoned, butter
Cod fillet, 3–3.5 cm thick	Marinated
Cod fillet roulade	Stuffed, marinated
Salmon fillet, 2.5–3 cm thick	Marinated
Salmon cutlet	Marinated
Salmon kebab, large chunks	Marinated
Pollock fillet, 180 g	Topping: spinach and crème fraîche
Pollock fricassee, large chunks	With white sauce
Catfish kebab, large chunks	Marinated
Side dishes	
Basmati rice	Salt, ratio 1 : 2.5 (rice : liquid)
Fresh pasta, tortellini	Sauce, salt
Gnocchi (convenience)	Salt, covered with water
Potatoes, floury, halved	Salt
Potatoes ² , sliced or small cubes	Salt
Potatoes ² , quartered or in wedges	Salt

Special applications

Food	Cooking tip
Boil-in-the-bag potato dumplings (convenience)	Covered with water
Mashed potato, cooked	–
Mashed potato (convenience), dry product	According to the packet instructions
Macaroni, short, uncooked	Sauce, ratio 1 : 3 (pasta : water)
Brown rice, cooking duration 8 minutes	Salt, ratio 1 : 2 (rice : liquid)
Parboiled rice (convenience), cooking duration 8 minutes	Salt, ratio 1 : 2 (rice : liquid)
Parboiled rice, cooking duration 10–12 minutes	Salt, ratio 1 : 2 (rice : liquid)
Rice (convenience), pre-cooked	Salt
Potato dumplings (convenience)	Salt, small chunks of butter
Vermicelli, uncooked	Covered with stock
Vegetables	
Cauliflower, large florets	Salt
Beans, green (string beans)	With bacon or salt, pepper
Broccoli, large florets	With/without cheese sauce
Cherry tomatoes, whole	Marinated
Kohlrabi, sliced	Salt and pepper
Squash, in small cubes	Salt and pepper
Corn on the cob	Herb butter
Carrots, quartered or in thick slices	Seasoned
Pepper, large chunks	Marinated
Ratatouille, roughly chopped	Tomato purée, ketchup, seasoning, cornflour
Brussel sprouts, whole	Salt and pepper
Asparagus, spears, whole, 1–2 cm thick	Salt, pepper, small chunks of butter
Courgettes, sliced, 2 cm thick	Oil, salt, pepper

¹ Add 1 tsp cornflour to raw meat/fish.

² Fairly firm

Special applications

Blanching

Blanch vegetables before freezing them. Blanching helps maintain the quality of the produce when it is frozen.

Blanching vegetables also helps them retain their original colour.

- Put the prepared vegetables into a perforated cooking container.
- Once blanched, plunge the vegetables into ice cold water to cool them down quickly. Drain them well.

Settings

Special applications  | Blanching

or

Oven functions  | Steam cooking 

Temperature: 100 °C

Blanching time: 1 minute

Bottling

Only use unblemished, fresh produce which is in good condition for bottling.

Glass jars

Use clean glass jars and accessories and check them for any defects. Glass jars with twist off lids or glass lids with a rubber seal are suitable.

Make sure that all the jars are the same size so that bottling is carried out evenly.

After you have filled the jars with the bottled produce, clean the glass rims with a clean cloth and hot water and then seal the jars.

Fruit

Sort fruit carefully, rinse it briefly but thoroughly and allow it to drain. Take great care when cleaning soft fruit as it is very delicate and squashes easily.

Remove any peel, stalks, cores or stones. Cut up large fruit. For example, cut apples into slices.

If you are bottling fruit with stones (e.g. plums, apricots) without removing the stones, pierce the fruit several times with a fork or wooden skewer as otherwise it will burst.

Vegetables

Rinse, clean and cut up vegetables.

Vegetables should be blanched before bottling to help them retain their colour (see “Special applications” – “Blanching”).

Fill volume

Fill the glass jars with produce up to a maximum of 3 cm below the rim. Do not pack it down as this will damage the cell walls of the produce. Tap the jar gently onto a cloth to help distribute the contents evenly. Fill the jars with liquid. The produce must be completely covered.

Use a sugar solution for fruit and a salt or vinegar solution for vegetables.

Tips

- Make use of residual heat by leaving the jars in the oven for 30 minutes after it has switched off.
- Then cover the jars with a cloth and allow to cool for approx. 24 hours.

Bottling food

- Place a perforated container or the rack in level 1.
- Place the jars in the perforated container or on the rack. The jars must not touch each other.

Settings

Special applications  | Bottling
or

Oven functions  | Steam cooking 

Temperature: see table

Bottling duration: see table

Special applications

The durations specified in the chart are guidelines only.

Food to be bottled	🌡️ [°C]	🕒* [min]
Berries		
Currants	80	50
Gooseberries	80	55
Cranberries	80	55
Fruit with stones		
Cherries	85	55
Mirabelle plums	85	55
Plums	85	55
Peaches	85	55
Greengages	85	55
Fruit with pips		
Apples	90	50
Apple sauce	90	65
Quinces	90	65
Vegetables		
Beans	100	120
Broad beans	100	120
Gherkins	90	55
Beetroot	100	60

🌡️ Temperature 🕒 Duration

* Bottling times apply to 1.0 l jars. If using 0.5 l jars, reduce the duration by 15 minutes. If using 0.25 l jars, reduce the duration by 20 minutes.

Bottling cakes

Creamed, sponge and yeast dough mixtures are all suitable for bottling. Cakes will keep for approx. 6 months.

Cakes **made with fresh fruit** are **not suitable for long term storage**, and must be consumed within 2 days of being made.





Only use sterilised jars and accessories. The jars must be narrower at the bottom than at the top (mason jars). 0.25 l jars are the best for this purpose.

Jars must have a glass lid with a rubber ring and metal spring clamp to seal them.



Make sure that all the jars are the same size so that the preserving process is carried out evenly.

- Grease the inside of the jars with butter up to 1 cm below the rim.
- Sprinkle fine breadcrumbs inside the jars.
- Fill the jars $\frac{1}{2}$ to $\frac{2}{3}$ full with mixture (depending on recipe). Make sure the rim stays clean.
- Place the rack in shelf level 1.
- Place the **open** jars (all the same size) on the rack. The jars must not touch each other.
- Close the jars **immediately** after bottling by clamping the glass lid down securely. Do not let the cakes cool down. If the mixture has risen above the rim, it can be pushed back down into the jar with the glass lid.

The durations specified in the chart are guidelines only. We recommend selecting the shorter duration initially. You can extend the duration if necessary.



Type of mixture	Operating mode	Stage	🌡️ [°C]	ΔΔ [%]	🕒 [min]
Batter		–	160	–	35–45
Sponge		–	160	–	50–55
Yeast dough	 	1	30	100	10
		2	160	30	30–35

🌡️ Temperature, ΔΔ Moisture, 🕒 Duration

 Conventional heat,  Combination cooking + Conventional heat

Special applications

Drying food

Only use the Drying special application or the Combi mode  | Combi Fan plus  function to dry food so that moisture can be dissipated.

- Cut the food into similar sized pieces.
- Spread out across the rack covered in baking parchment.

Tip: Bananas and pineapple are not suitable for drying.

Settings

Special applications  | Drying

Temperature: see chart

Drying time: see chart

or



Oven functions  | Combi mode  | Combi Fan plus 

Temperature: see chart

Moisture: 0 %

Drying time: see chart

The durations specified in the chart are guidelines only. We recommend selecting the shorter drying time initially. You can make the drying time longer if necessary.

Food	 [°C]	 [h]
Apple, rings	70	6–8
Apricots, halved, stones removed	60–70	10–12
Pears, sliced	70	7–9
Herbs	60	1.5–2.5
Mushrooms	70	3–5
Tomatoes, sliced	70	7–9
Citrus fruit, sliced	70	8–9
Plums, stones removed	60–70	10–12

 Temperature,  Duration (hours)

Prove dough

- Prepare the dough according to the recipe.
- Place the dough in an uncovered bowl in a perforated container or on the inserted rack.
Depending on the size of the bowl, you can also place the rack on the floor of the oven compartment with the rack surface facing up and place the bowl on top. If necessary, you can also remove the side runners.

Settings

Special applications  | Prove dough
or

Oven functions  | Combi mode  |
Combi Fan plus 

Temperature: 30 °C

Moisture: 100 %

Duration: as per recipe instructions

Menu cooking – automatic

When cooking a menu automatically, you can combine up to 3 different foods with different cooking durations, e.g. fish fillet with rice and vegetables. The food is placed in the steam oven compartment at different times so that each item is ready at the same time. You can select the food in any order because the steam oven sorts the items according to the length of cooking duration and indicates when each item has to be placed in the oven.

The Finish at and Start at functions are not available in menu cooking.

Using the Menu cooking special application

- Fill the water container and insert it into the appliance.
- Select Special applications  | Menu cooking.
- Select the food you want.

Depending on the type of food selected, you will be asked about the size, weight and degree of cooking.

- Select the values required and then confirm with *OK*.
- Select Add food.
- Select the next food you want and proceed as described for the first type of food.

Special applications

- Repeat for the third type of food if necessary.

After confirming Start Menu cooking, you will be prompted to place the food into the appliance with the longest cooking duration.

- When using perforated containers to cook foods that produce a lot of liquid or have a distinctive colour, be sure to place them over the universal tray. This avoids any transfer of flavour or colour to other food and prevents liquid dripping onto food below it.

At the end of a heating-up phase, the steam oven will indicate when the next item of food has to be placed inside.

Once this time has been reached, a buzzer will sound.

This process is repeated if there is a third food item.

You can still cook food types not listed together. Please refer to “Menu cooking – manual” in the “Steam cooking” chapter for more information.

Disinfect items

The steam oven can be used to disinfect baby bottles and other containers so that at the end of the programme they are as germ free as they would have been had they been boiled. Check beforehand that all parts, teats etc. are declared by the manufacturer to be heat resistant to 100 °C and also that they can withstand hot steam.

Dismantle, clean and thoroughly rinse baby bottles. All parts of the bottles must be completely dry before they are reassembled to keep them germ free.

- Place the individual items on the rack or in a perforated container (on their sides or with the opening facing downwards) ensuring that they do not touch one another to allow hot steam to reach them from all sides.

Settings

Special applications  | Disinfect items

Duration: 1 minute to 10 hours

or

Oven functions  | Steam cooking 

Temperature: 100 °C

Duration: 15 minutes

Heat crockery

By pre-heating the crockery, the food does not cool down as quickly.

Use heat-resistant crockery.

- Place the rack on shelf level 2 and place the crockery to be pre-heated on it. Depending on the size of the crockery, you can also place the rack on the floor of the oven compartment with the rack surface facing up and the crockery on top. If necessary, you can also remove the side runners.
- Select Special applications .
- Select Heat crockery.
- Alter the recommended temperature if necessary and then set the time.

 Risk of injury caused by hot surfaces.

The steam oven gets hot during operation. You could burn yourself on the heater elements, oven compartment, side runners or accessories. Droplets of water may have accumulated underneath the crockery.

Use oven gloves when removing the crockery from the oven.

Keeping warm

You can keep food warm in the oven compartment for up to 2 hours.

In order to maintain the quality of food, select the shortest possible time.

- Select Special applications .
- Select Keeping warm.
- Place the food to be kept warm in the oven compartment and confirm with *OK*.
- Alter the recommended temperature if necessary and then set the time.

Special applications

Heating damp flannels

- Moisten the flannels and then roll them up.
- Place them beside one another in a perforated cooking container.

Settings

Automatic programmes Auto | Special | Heat damp flannels

or

Oven functions | Steam cooking

Temperature: 70 °C

Cooking duration: 2 minutes

Dissolve gelatine

- Soften **gelatine leaves** by leaving them in a bowl of cold water for 5 minutes. The gelatine leaves have to be fully covered with water. Remove the gelatine leaves from the bowl and squeeze them out. Empty the bowl. Place the squeezed gelatine leaves back in the bowl.
- Place **gelatine powder** in a bowl and add water according to the instructions on the packaging.
- Cover the bowl and place in a perforated container.

Settings

Automatic programmes Auto | Special | Dissolve gelatine

or

Oven functions | Steam cooking

Temperature: 90 °C

Cooking duration: 1 minute

Decrystallise honey

- Loosen the lid and place the jar of honey in a perforated container.
- Stir the honey once during the cooking duration.

Settings

Automatic programmes Auto | Special | Decrystallise honey

or

Oven functions | Steam cooking

Temperature: 60 °C

Cooking duration: 90 minutes (irrespective of the size of jar or the amount of honey in the jar)

Melt chocolate

You can use the steam oven for melting any type of chocolate.

When using a cake covering, place it in a perforated cooking container, leaving it in its packaging.

- Break the chocolate into small pieces.
- Place larger quantities in a solid cooking container and smaller quantities in a cup or a bowl.
- Cover the container or the dish with a lid or with foil that is resistant to temperatures up to 100 °C and to hot steam.
- Stir large quantities once halfway through cooking.

Settings

Automatic programmes Auto | Special | Melt chocolate

or

Oven functions | Steam cooking

Temperature: 65 °C

Cooking duration: 20 minutes

Special applications

Make yoghurt

To make yoghurt, you will need either fresh live yoghurt or yoghurt culture, obtainable from health food shops.

Use natural yoghurt with live culture and without additives. Heat-treated yoghurt is not suitable.

The yoghurt must be fresh (short storage time).

You can use either unchilled long-life milk or fresh milk.

Long-life milk can be used as it is – no further preparation is required. Fresh milk must first be heated to 90 °C (do not boil it) and then cooled down to 35 °C. Fresh milk will give a better set than long-life milk.

The yoghurt and milk should have the same percentage fat.

Do not move or shake the jars whilst the yoghurt is thickening.

Immediately after preparation, leave the yoghurt to cool in the fridge.

How well home-prepared yoghurt sets will depend on the consistency, fat content and the cultures used in the starter yoghurt. Not all yoghurts are suitable for use as starter yoghurt.

Tip: When using yoghurt enzyme, yoghurt can be made from a milk / cream mixture. Mix $\frac{3}{4}$ litre milk with $\frac{1}{4}$ litre cream.

- Mix 100 g yoghurt with 1 l milk or make up the mixture with yoghurt enzyme, following the instructions on the packaging.
- Pour the mixture into jars and seal the jars.
- Place the sealed jars in a perforated container, making sure they do not touch one another.
- Immediately after the yoghurt has been made, place the jars in the refrigerator, taking care not to shake them unnecessarily.

Settings

Automatic programmes Auto | Special |
Make yoghurt

or

Oven functions | Steam cooking
Temperature: 40 °C
Duration: 5:00 hours

Possible reasons for unsatisfactory results

Yoghurt has not set:

Incorrect storage of starter yoghurt, too much time out of the refrigerator, e.g. in transportation, damaged packaging, milk not sufficiently heated.

Liquid has separated:

The jars were moved, yoghurt was not cooled down quickly enough.

Yoghurt is gritty:

Milk was overheated or in poor condition, milk and starter yoghurt not evenly stirred.

Cook bacon

The bacon does not brown.

- Place the bacon (diced or rashers) in a solid cooking container.
- Cover the container with foil that is temperature-resistant up to 100 °C and resistant to steam.

Settings

Automatic programmes Auto | Special |
Render fat

or

Oven functions | Steam cooking
Temperature: 100 °C
Cooking duration: 4 minutes

Sweat onions

Sweating means cooking the onions in their own juices, with the addition of a little fat if necessary.

- Cut the onions up into small pieces and place them in a solid cooking container with a little butter.
- Cover the container with foil that is temperature-resistant up to 100 °C and resistant to steam.

Settings

Automatic programmes Auto | Special |
Sweat onions

or

Oven functions | Steam cooking
Temperature: 100 °C
Cooking duration: 4 minutes

Special applications

Extracting juice with steam

This appliance is ideal for extracting juice from soft, firm and hard fruit.

It is best to use overripe fruit, as the riper the fruit, the greater the quantity of juice produced. Very ripe fruit will also produce a more intense flavour.

Preparation

Sort and clean the fruit. Cut out any blemishes.

Remove the stalks from grapes and morello cherries as these are bitter. Berries do not need to have their stalks removed.

Cut larger fruit such as apples into chunks of approximately 2 cm in size. The harder the fruit, the smaller the pieces should be.

Tips

- Try experimenting with mild and tart fruit.
- Adding sugar will increase the quantity of juice produced and improve the flavour. Sprinkle the fruit with sugar and leave to absorb for a few hours before juicing. For 1 kg of sweet fruit add 50–100 g of sugar, and for 1 kg of tart fruit add 100–150 g of sugar.
- If you wish to bottle the juice rather than consume it straight away, pour it whilst hot into hot, sterilised bottles, and then seal immediately with sterilised tops.

Extracting juice from fruit

- Put the prepared fruit into a perforated cooking container.
- Place a solid cooking container or the universal tray underneath in order to collect the juice.

Settings

Oven functions | Steam cooking

Temperature: 100 °C

Duration: 40–70 minutes

Fruit preserve

Only use unblemished, fresh produce which is in good condition.

Glass jars

Only use sterilised jars with twist-off lids up to a maximum capacity of 250 ml.

After pouring in the fruit, clean the rim of the jar with a clean cloth and hot water.

Preparation

Sort fruit carefully, rinse it briefly but thoroughly and allow it to drain. Take great care when cleaning soft fruit as it is very delicate and squashes easily. Remove any stalks, cores or stones.

Purée the fruit as otherwise the preserve will not set. Add jam sugar to the fruit (according to packet instructions) and stir well.

For sweet fruit and berries you should also add some citric acid.

Making fruit preserve

- Fill jars maximum 2/3 full.
- Place the jars without their lids on in a perforated container or on the rack.
- At the end of the cooking duration, take the jars out of the steam oven using oven gloves. Leave them to stand for 1–2 minutes before sealing them with lids and then leave them to cool.

Settings

Oven functions | Combi mode

Combi Fan plus

Temperature: 150 °C

Moisture: 0 %

Duration: 35–45 minutes

Special applications

Skinning vegetables and fruit

- Cut a cross in the top of tomatoes, nectarines etc. This will allow the skin to be removed more easily.
- Place the fruit/vegetables in a perforated cooking container if using steam cooking and on the universal tray if using the grill.
- To blanch almonds, it is important to plunge them into cold water as soon as they are taken out of the oven. Otherwise the skin cannot be removed.

Settings

Oven functions | Full grill

Level: 3

Duration: see chart

Food	🕒 [min]
Peppers	10
Tomatoes	7

🕒 Duration

Settings

Oven functions | Steam cooking

Temperature: 100 °C

Duration: see table

Food	🕒 [min]
Apricots	1
Almonds	1
Nectarines	1
Peppers	4
Peaches	1
Tomatoes	1

🕒 Duration

Apple storage

You can treat homegrown apples in the steam oven to increase the length of time for which you can store them. Once treated, the apples will keep for 5 to 6 months when stored in a dry, cool and well-ventilated place. This method is only suitable for apples and not for other types of fruit.

Settings

Automatic programmes Auto | Fruit | Apples | Whole

or

Oven functions | Steam cooking 
Temperature: 50 °C
Preserving time: 5 minutes

Making eierstich

- Mix 6 eggs with 375 ml milk (do not beat into a foam).
- Season the egg and milk mixture and pour into a solid cooking container greased with a little butter.

Settings

Oven functions | Steam cooking 
Temperature: 100 °C
Cooking duration: 4 minutes

Automatic programmes

The wide range of automatic programmes enables you to achieve excellent results with ease.

Categories

The  automatic programmes are sorted into categories to provide a better overview. Simply select the appropriate programme for the type of food you are cooking and follow the instructions in the display.

Using automatic programmes

- Select Automatic programmes .

A list will appear in the display.

- Select the desired food category.

The automatic programmes available for the food category selected will then appear.

- Select the desired automatic programme.
- Follow the instructions in the display.

Some automatic programmes and special applications will prompt you to use the food probe. Read the information under “Roasting – Food probe”.

The core temperature cannot be changed for the automatic programmes.

Tip: Use  Info to display information such as how to place or turn the food depending on the cooking programme.

Usage notes

- The degree of cooking and browning are represented by a bar with seven segments. You can set how well you want the food cooked or how brown you want it to be by touching the relevant segment.
- Some roasting programmes also offer the **Roast with moisture** option. With this option meat is cooked at a low temperature over a long cooking duration for tender and succulent results. The additional moisture helps to achieve the best cooking and browning result: the meat is very succulent and tender. The cut is cooked evenly and has a thin brown outer layer that forms during the roasting programme. It is therefore not necessary to sear the meat beforehand. In contrast to the **Roast** option, there is no need to use the food probe in this case and you can set a start or end time to suit your menu planning.
- The weights specified in the automatic programmes refer to the weight per piece. For example, you can cook just one piece of salmon weighing 250 g or 10 pieces of salmon, each weighing 250 g, at the same time.
- The steam oven compartment needs to cool to room temperature before starting an automatic programme.

- When you place food into the hot oven compartment, be careful when opening the door. Hot steam may escape. Step back and wait until the steam has dissipated. Avoid contact with hot steam, and do not touch the hot oven compartment walls. Danger of burning and scalding.
- Please refer to the cookbook for information on suitable baking containers.
- For some automatic programmes, the start time can be delayed using **Start at** or **Finish at**. The individual cooking stages of the automatic programme are listed under the **Display cooking stages** menu option.
- If by the end of an automatic programme the food is not cooked enough, select **Continue cooking** or **Continue baking**.
- Automatic programmes can also be saved as **User programmes**.

Search

(Depending on language)

Under **Automatic programmes**, you can search by the name of the categories and the automatic programmes.

There is a full text search function which can also be used to search for parts of words.

From the main menu:

- Select **Automatic programmes** **Auto**.

The category list will appear in the display.

- Select **Search**.

- Use the keyboard to type in the search text, e.g. "Bread".

The number of hits will be shown in the footer.

If no match is found, or if there are more than 40 matches, the **hits** field is deactivated and you will need to change the search text.

- Select **XX hits**.

The categories and automatic programmes available will then appear.

- Select the desired automatic programme, or the category and then the automatic programme.

The automatic programme will start.

- Follow the instructions in the display.

MyMiele

Under MyMiele , you can save frequently used applications.

It is particularly useful with automatic programmes as you do not need to work through every screen in order to start your programme.



Tip: You can also set menu options that you have entered in MyMiele as your status display (see “Settings – Status display”).

Adding entries

You can add up to 20 entries.

- Select MyMiele .
- Select Add entry.

You can select sub-menus from the following:

- Oven functions 
- Automatic programmes 
- Special applications 
- User programmes 
- Maintenance 

- Confirm with OK.

The selected sub-option with its symbol appears in the list.

- Proceed as described for further entries. Only sub-options which have not yet been added are available for selection.

Deleting entries

- Select MyMiele .
- Touch the entry you want to delete and keep your finger on it until the context menu appears.
- Select Delete.

The entry will then be removed from the list.

Moving entries

- Select MyMiele .
- Touch the entry you want to move and keep your finger on it until the context menu appears.
- Select Move.

An orange border appears around the entry.

- Move the entry.

The entry appears in the desired position.

You can create and save up to 20 of your own programmes.

- You can combine up to 9 cooking stages to accurately programme your favourite or most frequently used recipes. In each cooking stage, you can select settings such as the function, temperature and cooking duration.
- You can enter the name of the programme for your recipe.

When you call up and start your programme again, it will run automatically.

There are different ways of creating a user programme:

- At the end of an automatic programme or special application, save it as a user programme.
- Save a cooking programme after running it with a set cooking duration.

Then enter a programme name.

Creating user programmes

- Select **User programmes** .
- Select **Create programme**.

You can now specify the settings for the first cooking stage.

Follow the instructions in the display:

- Select and confirm the settings you want.

If you select the **Pre-heat** function, use **Add** to add another cooking stage where you set a cooking duration. Only then can you save or start the programme.

All settings for the first cooking stage have now been set.

You can add more cooking stages, for example, if you want to add another cooking function to follow on from the first.

- If additional cooking stages are required, select **Add** and proceed as for the first cooking stage.

If you want to check the settings or to change them at a later stage, touch the cooking stage in question.

- When you have finished setting all the cooking stages, select **Save**.
- Enter the programme name using the keyboard.

You can add a line break for longer programme names using the **↵** symbol.

- Once you have entered the programme name, select **Save**.

User programmes

A message will appear in the display confirming that the programme name has been saved.

- Confirm with *OK*.

You can start the saved programme immediately, delay the start or change the cooking stages.

Starting user programmes

- Place the food in the oven compartment.
- Select User programmes .
- Select the programme you want to use.

Depending on the programme settings, the following menu options appear in the display:

- Start now
The programme will start immediately. The oven heating will switch on immediately.
- Finish at
Specify the time you want the programme to stop. The oven heating will switch off automatically at the time you have set.
- Start at
Specify the time when you want the programme to start. The oven heating will switch on automatically at the time you have set.
- Display cooking stages
A summary of your settings will appear on the display.
- Display actions
The required actions, e.g. placing the food in the oven, will appear in the display.

- Select the menu option you want.

The programme selected will begin straight away or at the time set.

Use  Info to display information such as how to place or turn the food depending on the cooking programme.

- At the end of the programme, select *Close*.

Changing cooking stages

Cooking stages in automatic programmes that have been saved under a different name cannot be changed.

- Select **User programmes** .
- Touch the programme you want to change and keep your finger on it until the context menu appears.
- Select **Change**.
- Select the cooking stage that you want to change or **Add** to add another cooking stage.
- Select and confirm the desired settings.
- If you want to start the modified programme without changing it, select **Start**.
- Select **Save** when you have changed all the settings.

A message will appear in the display confirming that the programme name has been saved.

- Confirm with **OK**.

The saved programme has been changed and you can start it immediately or delay the start.

Renaming User programmes

- Select **User programmes** .
- Touch the programme you want to change and keep your finger on it until the context menu appears.
- Select **Rename**.
- Change the programme name using the keyboard.

You can add a line break for longer programme names using the **↵** symbol.

- Once you have changed the programme name, select **Save**.

A message will appear in the display confirming that the programme name has been saved.

- Confirm with **OK**.

The programme has now been renamed.

User programmes

Deleting User programmes

- Select User programmes .
- Touch the programme you want to delete and keep your finger on it until the context menu appears.
- Select Delete.
- Confirm the query with Yes.

The programme will be deleted.

Go to Settings | Factory default | User programmes to delete all User programmes at the same time.

Moving User programmes

- Select User programmes .
- Touch the programme you want to move and keep your finger on it until the context menu appears.
- Select Move.

An orange border appears around the entry.

- Move the programme.

The programme appears in the desired position.

Handling food carefully will help protect your health.

Cakes, pizzas and french fries should be cooked until golden, not dark brown.

Baking tips

- Set a cooking duration. When baking, the oven should not be set to start a long time off. Otherwise the cake mixture or dough will dry out, and the raising agents will lose their effectiveness.
- Generally speaking, you can use racks, universal trays and any type of baking tray made of heat-resistant material.
- Always place baking tins on the rack.
- Always cook frozen goods such as cakes, pizza or baguettes on the rack.

Very high temperatures can cause the universal tray to distort to such an extent that the tray cannot be taken out of the oven compartment.

- Small items of frozen food such as oven chips or potato croquettes can be cooked on the universal tray. Turn these frozen food items several times during cooking.
- Bake on a maximum of 2 levels at the same time. When baking cakes with a moist topping, only bake on one level.

Using baking parchment

Miele accessories, e.g. the universal tray, are treated with PerfectClean (see "Cleaning and care"). Surfaces treated with PerfectClean generally do not need to be greased or covered with baking parchment.

■ Use baking parchment when cooking:

- lye mixtures because anything prepared using a lye containing sodium hydroxide can damage the PerfectClean surface
- mixtures with a high egg white content, such as sponge, meringue and macaroons, as these can easily stick
- puff pastry or strudel dough
- frozen food on the rack
- small items of frozen food such as oven chips or potato croquettes on the universal tray

Baking

Tips on baking

- Dark tins are best for baking. Avoid using bright, thin-walled tins as they give an uneven or poor browning result. In certain unfavourable conditions, the food will not cook properly.
- Position rectangular tins with the longer side across the width of the oven compartment for optimum heat distribution and even baking results.
- When cooking frozen food such as chips, croquettes, cakes, pizza and baguettes, select the medium temperature quoted on the manufacturer's packaging.
- If a range is specified for the cooking duration, check whether the food is cooked after the shortest duration. Stick a wooden skewer into the food. If it comes out clean without any batter/dough on it, the food is done.



Notes on the functions

You can find an overview of all the functions with their recommended values in “Main and sub-menus”.

Combi mode

This function uses a combination of oven heat and moisture. The addition of steam prevents the surface of the food from drying out. Bread, bread rolls and puff pastry have a shiny and crunchy crust.

You can choose between different types of heating:

- Combi Fan plus 
- Combi Conventional 
- Combi Grill 

We recommend baking bread and bread rolls in several cooking stages: the shine is created during the 1st cooking stage thanks to the injection of steam (maximum moisture, low temperature). Browning takes place in the next cooking stage with high moisture and a high temperature. It is then dried with reduced moisture and a medium to high temperature.

Tip: Recipes and comprehensive cooking charts with information on functions, temperatures, moisture and cooking durations can be found in the “Steam combination oven” cookbook.

Automatic programmes

Please refer to the cookbook for information on suitable baking containers.

Follow the instructions on the display.

Fan plus

Use this function if you are baking on multiple shelves at the same time.

You can use any type of baking tray made of heat-resistant material.

Because the fan distributes the heat around the oven compartment straight away, it allows you to use a lower temperature than you would with the Conventional heat  function.

Conventional heat

Use this function for baking traditional recipes. If using an older recipe or cookbook, set the oven temperature 10 °C lower than the recommended one. This will not change the cooking duration.

Only bake on one level. If you are making a tray bake, use level 2.

Intensive bake

This function is suitable for baking cakes with moist toppings, pizza, quiche, etc.

Place the food in shelf level 1.

Bottom heat

Use this function towards the end of cooking to brown the base of the food.

Top heat

Use this function towards the end of cooking to brown the top of the food being cooked.

This function is suitable for gratins and for browning bakes.

Cake plus

Use this function for baking batter and frozen lye mixtures.

Eco Fan heat

This function is suitable for making sweet and savoury bakes and gratins in a way that saves energy.

Roasting

Tips for roasting

- Frozen meat must be defrosted before it is cooked as otherwise it would dry out. Always defrost meat before roasting.
- Remove skin and sinew before roasting.
- Marinate and season the meat to taste.
- If you are cooking several pieces of meat together, use pieces that are similar in size.
- Use the universal tray with the rack placed on top of it. The oven compartment stays cleaner and you can then use the meat juices collected to make a gravy or sauce.



- Allow a standing time of approx. 10 minutes before carving meat. This resting time ensures the meat juices are distributed evenly.



Notes on the functions

You can find an overview of all the functions with their recommended values in “Main and sub-menus”.

Combi mode

This function uses a combination of oven heat and moisture. The addition of steam prevents the surface of the food from drying out. The results are particularly tender and succulent meat with a well-browned outside. Use the Combi mode  function for cooking meat, fish and poultry dishes.

You can choose between different types of heating:

- Combi Fan plus 
- Combi Conventional 
- Combi Grill 

We recommend cooking meat slowly and gently in several cooking stages: at a high temperature during the 1st cooking stage to brown the surface. The 2nd cooking stage requires increased moisture and a reduced temperature. The meat cooks evenly and the muscle protein is broken down, making the meat particularly tender.

Tip: Recipes and comprehensive cooking charts with information on functions, temperatures, moisture and cooking durations can be found in the “Steam combination oven” cookbook.

Automatic programmes

Follow the instructions on the display.

Fan plus

This function is suitable for roasting meat and poultry that needs to be well browned.

Because the fan distributes the heat around the oven compartment straight away, it allows you to use a lower temperature than you would with the Conventional heat  function.

Conventional heat

Use this function for baking traditional recipes. If using an older recipe or cookbook, set the oven temperature 10 °C lower than the recommended one. This will not change the cooking duration.

Use the Bottom heat  function towards the end of the cooking duration to brown the base of the food.

Do not use the Intensive bake  function for roasting as the juices will become too dark.

Roasting

Food probe

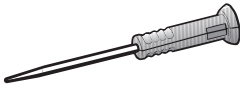

The food probe allows the temperature to be monitored precisely during a cooking programme.

How it works

The metal tip of the food probe must be fully inserted into the centre of the food. There is a temperature sensor in the metal tip which measures the core temperature of the food during cooking.

The core temperature set will depend on how well cooked you want your meat to be and on the type of meat. The temperature can be set between 30 and 99 °C.

The cooking duration will depend on a number of different factors. The higher the temperature in the oven compartment and the moisture, where applicable and the thinner the food, the quicker the set core temperature will be reached.

The core temperature values are sent via a signal from the transmitter in the handle of the food probe via the antenna to the steam oven's electronic unit as soon as the food with the food probe is placed in the oven compartment.

Efficient radio transmission is only guaranteed if the oven door is closed. If the door is opened during a cooking programme, e.g. to baste the food, radio signal transmission is interrupted.

It will only resume when the door is closed. It will take a few seconds before the current core temperature appears again in the display.

 Damage due to high temperatures.









The temperature sensor of the food probe will be damaged at temperatures over 100 °C.

The food probe should be reinserted in its holder when it is not being used.

When to use the food probe

Some automatic programmes and special applications will prompt you to use the food probe.

You can also use the food probe with User programmes and with the following functions:

- Fan plus 
- Conventional heat 
- Combi Fan plus 
- Combi Conventional 
- Steam cooking 
- Intensive bake 
- Fan grill 
- Cake plus 

Important usage notes

To ensure the probe works correctly, please observe the following instructions.

The metal tip of the food probe can break.

Do not use the food probe to lift or carry the food.

- Do not use tall, narrow metal cooking containers as these can weaken the signal.
 - For wireless food probes, avoid placing metal objects above them, such as a lid, aluminium foil, the wire rack or the universal tray on the shelf levels above. Glass lids can be used.
 - Do not use another proprietary metal food probe at the same time.
 - Ensure that the handle of the food probe is not sitting in the cooking liquid, on the food or on the edge of the cooking container.
 - You can place the meat in a pot or on the rack.
 - The metal tip of the food probe must be fully inserted into the centre of the food so that the temperature sensor reaches more or less to the core. The handle should point diagonally upwards and not horizontally towards the corners of the oven or the door.
 - When cooking poultry, insert the metal tip into the thickest part of the breast. Press the breast with your index finger and thumb to find the thickest part.
- The metal tip must not touch any bone or be inserted in areas with a lot of fat. Heavily marbled areas and bones can cause cooking to end prematurely.
 - If the meat is very heavily marbled with fat, select the highest core temperature given in the cooking charts.
 - When using aluminium foil or roasting bags, insert the food probe through the foil/bag into the centre of the food. You can also place meat inside the bag or foil with the food probe already inserted. Follow the roasting bag manufacturer's instructions.
 - The food probe can only be inserted almost horizontally in very flat pieces of food such as fish. Therefore cook flat food in glass or ceramic cooking containers as the walls of a metal cooking container would disrupt the radio signals.

A message will appear in the display if the food probe is no longer recognised during a cooking process. Change the position of the food probe in the food.

Roasting

Using the food probe

- Remove the food probe from its holder behind the panel.
- Insert the metal tip of the food probe completely into the centre of the food.

If you are cooking several pieces of meat at the same time, insert the food probe into the largest piece of meat.

The handle should be pointing diagonally upwards.

- Place the food in the oven compartment.
- Close the door.
- Select the function or automatic programme.
- Set the temperature and the core temperature if necessary.

The core temperature cannot be changed for the automatic programmes.

Follow the instructions on the display.

The cooking programme is brought to an end as soon as the core temperature is reached.

 Risk of injury caused by hot surfaces.

The handle of the food probe can get hot. You can burn yourself on the handle.

Wear oven gloves when removing the food probe.

Tip: If the food is not cooked sufficiently when the core temperature is reached, insert the food probe into another place or increase the core temperature and repeat the programme.

Delaying the start of a cooking programme with food probe

You can set the cooking programme to start at a later time.

- Select **Start at**.

The finish time can be calculated approximately because the duration of a cooking programme is about the same, whether or not the food probe is used.

You cannot set **Duration** and **Finish at** because the total cooking duration is determined by when the set core temperature is reached.

Chart with core temperatures

Meat	 [°C]
Roast veal	75–80
Gammon joint	63
Leg of lamb pink medium well done	64 76 82
Saddle of lamb pink medium well done	53 65 80
Saddle of venison pink medium well done	60 72 81
Roast beef	80
Fillet of beef/ sirloin joint pink medium well done	45 54 75
Roast ham/pork	85
Pork fillet pink medium well done	60 66 75
Game/leg cut	85

 Core temperature

Grilling

 Risk of injury caused by hot surfaces.

If you open the appliance door during grilling, the control elements will get very hot.

Keep the door closed during the grilling programme.

Grilling tips

- Pre-heating is not necessary when grilling. Place the food in the cold oven compartment.
- Use the universal tray with the rack placed on top of it. Exception: If you are grilling on level 3, insert the universal tray one level down from the rack.

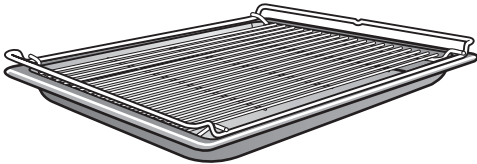

- When grilling fish, place the fish on a piece of baking paper cut to size.
- Grill thick food, e.g. half a chicken, on level 2 and thin food, e.g. steaks, on level 3.
- Turn the food $\frac{2}{3}$ of the way through the cooking duration. Exception: fish does not need to be turned.

Tips for grilling

- Marinate lean meat or brush it with oil. Do not use other types of fat as they can burn and cause smoke.
- Pierce sausages before grilling.
- It is best to grill food of a similar thickness at the same time so that the grilling time for each item does not vary too greatly.
- To **test the food**, press down on the meat with a spoon. This lets you determine how well the meat has been cooked.
 - **Rare/pink**
If the meat gives easily to the pressure of the spoon, it will still be red on the inside.
 - **Medium**
If there is some resistance, the inside will be pink.
 - **Well done**
If there is very little resistance, it is cooked through.
- To grill thicker pieces of food more gradually after an initial high temperature, continue grilling at a lower temperature setting or use a lower shelf level to allow the food to cook through to the centre.

Notes on the functions

You can find an overview of all the functions with their recommended values in “Main and sub-menus”.

The plastic on the food probe can melt at very high temperatures.

Do not use the food probe when using the grill functions.

Do not store the food probe in the oven compartment when it is not being used.

Combi Grill

This function is suitable for grilling food that should be brown on the outside, but not dry, e.g. corn on the cob.

Full grill

Use this function to grill flat thin cuts in large quantities and for browning large baked dishes.

Economy grill







Use this function to grill flat thin cuts in smaller quantities and for browning small baked dishes.

Fan grill

This function is suitable for grilling thicker food, such as poultry, rolled meat.

Note for test institutes

Test food according to EN 60350-1 (steam cooking functions)



Test food	Cooking containers	Quantity [g]	 ³		 ¹ [°C]	 [min]
Steam replenishment						
Broccoli (8.1)	1x DGGL 12	max.	2		100	3
Steam distribution						
Broccoli (8.2)	1x DGGL 20	300	2		100	3
Appliance capacity						
Peas (8.3)	2x DGGL 12	1500 each	1, 2		100	<u>2</u>

³ Level,  Function, ¹ Temperature,  Cooking duration

 Steam cooking,  Eco steam cooking

- 1 Place the test food in a cold oven compartment (before the heating-up phase begins).
- 2 The test is finished when the temperature measures 85 °C in the coolest place.















Menu cooking test food¹ (steam cooking function

Test food	Cooking containers	Quantity [g]	 ³	 ¹ [°C]	Height [cm]	 [min]
Potatoes, waxy, quartered ³	1x DGGL 20	800	3	100	–	17
Salmon fillet, frozen, not defrosted	1x DGGL 20	4 x 150	1	100	< 2.5 ≥ 2.5 ≤ 3.2 > 3.2	9 10 11
Broccoli florets	1x DGGL 20	600	2	100	–	4





³ Shelf level, ¹ Temperature,  Cooking duration

- 1 For instructions, see “Menu cooking – manual” in the “Steam cooking” chapter.
- 2 Place the universal tray on shelf level 1.
- 3 Place the 1st test food item (potatoes) in a cold oven compartment (before the heating up phase begins).

Test food according to EN 50304/EN 60350-1 (oven functions)

Test food	Accessories	 ³		 [°C]	 ² [min]		Pre-heat- ing
Shortbread biscuits (7.5.2)	1 baking tray	2		140	34–36 (34)	No	No
	2 baking trays	1		140	39–41 (40)	No	No
		3 ¹			36–38 (37)		
	1 baking tray	2		140	29–31 (28)	Yes	Yes
Small cakes (7.5.3)	1 baking tray	1		150	35–37 (37)	No	No
	2 baking trays	1, 2		140	44	No	No
Whisked sponge (7.6.1)	1 springform cake tin 26 cm (on rack)	2		160	30	Yes	Yes
Apple sponge (7.6.2)	1 springform cake tin 20 cm (on rack)	2		160	95–105 (100)	No	No
	2 springform cake tins 20 cm (on rack)	2		160	85–95 (90)	Yes	Yes
Industrially produced white bread (9.2)	Rack	2		Level 3	5	No	6 min.
Burger (9.3)	Rack	3		Level 3	1st side: 10 2nd side: 6	No	8 min.
	Universal tray	2					

³ Level,  Function,  Temperature/grill level, ² Cooking duration,  Booster

 Fan plus,  Conventional heat,  Cake plus,  Full grill

1 Take the trays out of the oven early if the food is sufficiently browned before the specified cooking duration has elapsed.

2 The value in brackets states the optimum cooking duration.

Cleaning and care

Important information on cleaning and care

 Risk of injury caused by hot surfaces.

The steam oven gets hot during operation. You could burn yourself on the heater elements, oven compartment, side runners or accessories.

Allow the heater elements, oven compartment, side runners and the accessories to cool before manual cleaning.

 Risk of injury due to electric shock.

The steam from a steam cleaning appliance could reach live electrical components and cause a short circuit.

Do not use a steam cleaner to clean the steam oven.

Surfaces can discolour or alter if unsuitable cleaning agents are used. The front of the steam oven is particularly susceptible to damage from oven cleaners and descaling agents. All surfaces are susceptible to scratching. Scratches on glass can in some circumstances lead to breakage.

Remove all cleaning agent residues immediately.

Stubborn soiling could damage the steam oven in certain circumstances. Once the oven has cooled, clean the oven compartment, the inside of the door and the door seal. Waiting too long can make cleaning unnecessarily difficult and in some cases impossible.

Do not use commercial cleaning agents. Only use agents designed for domestic use.

Do not use cleaning agents or washing-up liquids containing aliphatic hydrocarbons as these could cause the seals to swell.

- The steam oven and accessories should be cleaned and dried thoroughly after each use.
- Leave the appliance door open until the oven compartment is completely dry.

If the steam oven is not going to be used for a longer period of time, it should be thoroughly cleaned and dried beforehand to prevent the build-up of odours and so on. Leave the door open afterwards.

Unsuitable cleaning agents

To avoid damaging the surfaces of your appliance, do not use:

- Cleaning agents containing soda, ammonia, acids or chlorides
- Cleaning agents containing descaling agents
- Abrasive cleaning agents, e.g. powder cleaners and cream cleaners
- Solvent-based cleaning agents
- Stainless steel cleaning agents
- Dishwasher cleaner
- Glass cleaning agents
- Cleaning agents for ceramic glass hobs
- Hard, abrasive brushes or sponges (e.g. pot scourers, brushes or sponges which have been previously used with abrasive cleaning agents)
- Melamine eraser blocks
- Sharp metal scrapers
- Wire wool
- Stainless steel spiral pads
- Spot cleaning with mechanical cleaning agents
- Oven cleaners or sprays

Cleaning the steam oven front

- Clean the appliance front with a clean, soft sponge and a solution of warm water and washing-up liquid.
- After cleaning, wipe the surfaces dry using a soft cloth.

Tip: A clean, damp microfibre cloth without cleaning agent can also be used.

Cleaning and care

PerfectClean

The oven compartment, side runners, universal tray and combi rack surfaces are **treated with PerfectClean**. This finish has an iridescent appearance. PerfectClean surfaces have very good anti-stick properties and are easy to clean.

However, it is important to clean the surfaces each time the oven is used. The non-stick properties will deteriorate if soiling is not removed from PerfectClean surfaces after each use. If used frequently without being cleaned, cleaning may become very difficult.

Soiling such as spilt juices and cake mixtures are best removed whilst the oven compartment is still warm.

Spilt fruit juices may cause discolouration to the surfaces that cannot be removed. However, this does not affect the properties of the PerfectClean finish.

Always remove all cleaning agent residues to protect the non-stick properties.

To protect the non-stick effect of PerfectClean surfaces, please avoid:

- abrasive cleaning agents (e.g. powder cleaners, scouring milk, scouring pads)
- cleaning agents for ceramic glass hobs
- ceramic glass and stainless-steel cleaners
- steel wool
- abrasive sponges, e.g. pot scourers or sponges which have been previously used with abrasive cleaning agents
- oven spray
- spot cleaning with mechanical cleaning agents

Do **not** clean PerfectClean accessories in the dishwasher.

Oven compartment

The surface of the oven compartment has been treated with PerfectClean.

Please see “PerfectClean” in the “Cleaning and care” chapter for instructions on cleaning.

Ensure that no cleaning agent gets into the openings on the oven compartment rear panel.

To make cleaning the oven compartment easy, you can remove the oven door, dismantle the side runners and lower the top heat/grill element.

Cleaning after a programme using steam

- Remove:
 - condensate using a sponge or absorbent cloth
 - light, greasy soiling with a clean sponge and a solution of washing-up liquid and hot water
- After cleaning, wipe the surface with clean water to remove any cleaning agent residues.
- Then dry the oven compartment and the inside of the door with a cloth.

Tip: You can then leave the steam oven to dry automatically (see “Care” in the “Cleaning and care” chapter).

Cleaning after a roasting, grilling or baking programme

Clean the oven compartment thoroughly after roasting, grilling and baking as otherwise soiling can burn on and become impossible to remove.

- Clean the oven compartment and inside of the door with a clean dishwashing sponge, hot water and a little washing-up liquid. You can use the hard surface of a dishwashing sponge to clean the oven compartment if necessary.
- After cleaning, wipe the surface with clean water to remove any cleaning agent residues.
- Then dry the oven compartment and the inside of the door with a cloth.

Tip: Soaking the soiling for a few minutes with a solution of washing-up liquid and hot water can make cleaning easier. Alternatively, run the Maintenance Ⓢ | Soak programme (see “Care” in the “Cleaning and care” chapter).

Cleaning and care

Cleaning the floor filter

- The filter in the floor of the oven should be cleaned and dried after every use.
- Vinegar can be used to remove discolouration and limescale deposits from the filter in the floor of the oven. Rinse thoroughly with clean water afterwards.

Cleaning the door seal

The door seal may become brittle and tear on account of contact with grease residues.

Clean the door seal between the inside of the oven door and the oven compartment after every baking or roasting programme.

- Clean the door seal using a clean, damp microfibre cloth without any cleaning agent. You can also use a clean sponge and warm water with a little washing-up liquid.
- After cleaning dry the seal with a soft cloth.
- Replace the seal with a new one if it becomes porous or brittle.

Door seals can be ordered from the Miele Customer Service Department (see the end of these operating instructions for contact details).

Cleaning the water container and condensate container

The water container and condensate container are suitable for cleaning in a dishwasher.

- Remove the water container and condensate container after every use. Remove the water container and condensate container by pushing them upwards slightly.
- Empty the water container and condensate container.

Water can drip into the water container and condensate container compartment when removing the containers.

- Dry the compartment if necessary.
- Rinse the water container and condensate container by hand or in the dishwasher.
- Then dry the water container and condensate container with a cloth to prevent limescale.

Accessories

Cleaning the universal tray and combi rack

The surfaces of the universal tray and the combi rack have been treated with PerfectClean. Please see “PerfectClean” in the “Cleaning and care” chapter for instructions on cleaning.

- Remove:
 - light soiling with a clean sponge and a solution of washing-up liquid and hot water
 - stubborn soiling with a clean dish-washing sponge, hot water and a little washing-up liquid. If necessary, you can also use the rough side of the sponge.
- After cleaning, wipe the surface with clean water to remove any cleaning agent residues.
- Then dry the surfaces using a cloth.

Cleaning cooking containers and the food probe

The cooking containers and food probe are suitable for cleaning in a dishwasher.

- Wash and dry the cooking containers and food probe after each use.
- Any bluish discolouration on the cooking containers can be removed with vinegar. Then rinse with clean water.

Cleaning and care

Cleaning the side runners

The surfaces of the side runners have been treated with PerfectClean. Please see “PerfectClean” in the “Cleaning and care” chapter for instructions on cleaning.

The side runners can be removed together with the FlexiClip runners (if inserted).

If you want to remove the FlexiClip runners separately beforehand, please follow the instructions in “Fitting and removing FlexiClip runners” in the “Guide to the appliance” chapter.

! Risk of injury caused by hot surfaces.

The steam oven gets hot during operation. You could burn yourself on the heater elements, oven compartment or accessories.

Allow the heater elements, oven compartment and accessories to cool before removing the side runners.

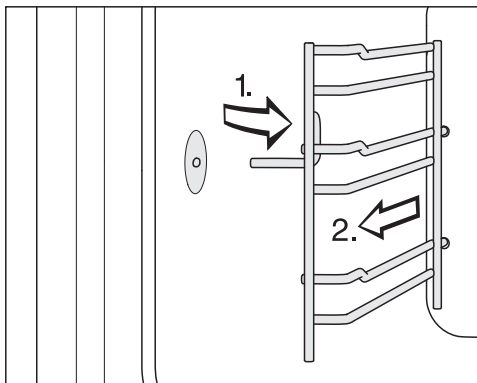

- Pull the side runners out of holder (1.) from the front and remove them (2.).

- Remove:

- light soiling with a clean sponge and a solution of washing-up liquid and hot water
- stubborn soiling with a clean dish-washing sponge, hot water and a little washing-up liquid. If necessary, you can also use the rough side of the sponge.

- After cleaning, wipe the surface with clean water to remove any cleaning agent residues.

- Then dry the side runners with a cloth.

Reassemble by following these instructions in reverse order.

- Refit the side runners carefully.

If the side runners are not correctly inserted, there is no anti-tip protection. The temperature sensor could also be damaged when cooking containers are placed in the steam oven.

Lowering the top heat/grill element

If the oven compartment roof is badly soiled, the top heat/grill element can be lowered by approx. 5 cm to make cleaning easier.

 Risk of injury caused by hot surfaces.

The steam oven gets hot during operation. You could burn yourself on the heater elements, oven compartment, side runners or accessories. Allow the heater element, oven compartment, side runners and the accessories to cool before cleaning.

Be careful not to damage the top heat/grill element.

Never use force when pulling down the top heat/grill element.

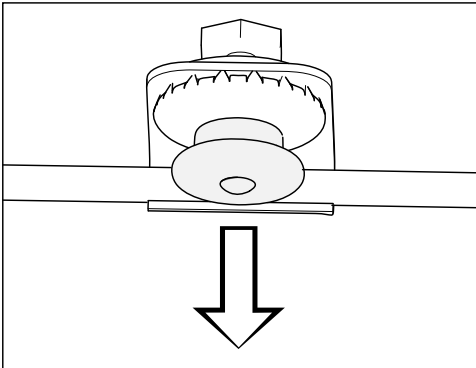

- Carefully pull down the pressure cap. The top heat/grill element then lowers automatically.

- Clean the oven compartment roof with a sponge cloth or a dishwashing sponge (see “Oven compartment” in the “Cleaning and care” chapter).
- After cleaning the top heat/grill element, push the pressure cap back up. Make sure the pressure cap engages correctly.

Cleaning and care

Maintenance

The Finish at and Start at functions are not available with maintenance programmes.

Soaking

Stubborn soiling can be soaked using this maintenance programme.

- Allow the oven compartment to cool down.
- Take all accessories out of the oven compartment.
- Remove coarse soiling with a cloth.
- Fill the water container.
- Select Maintenance  | Soak.

The soaking process takes approx. 10 minutes.

Drying

This maintenance programme can be used to dry any residual moisture in the oven compartment, including in inaccessible areas.

- Dry the oven compartment with a cloth.
- Select Maintenance  | Drying.

The drying process takes approx. 20 minutes.

Rinsing

The water-carrying system is rinsed out during this maintenance programme. Any remaining food deposits are rinsed away.

- Select Maintenance  | Rinse.
- Follow the instructions on the display.

Rinsing takes approx. 10 minutes.

Descaling the steam oven

We recommend using Miele descaling tablets (see “Optional accessories”) to descale the appliance. These have been specially developed for use with Miele appliances to optimise the descaling process. Other descaling agents, which contain other acids besides citric acid and/or other undesirable substances, such as chlorides for example, could cause damage to the product. Moreover, the descaling result required could not be guaranteed if the descaling solution was not of the appropriate concentration.

Do not spill descaling agent onto metal surfaces. This can cause marks to appear. However, should any descaling agent get onto these surfaces, wipe it away immediately.

The steam oven has to be descaled after a certain number of operating hours. When the time comes to descale it, the number of uses remaining lights up in the display. It only counts the number of uses that use steam. The steam oven will be disabled after the last remaining cooking process.

We recommend that you descale the appliance before it locks out.

During the descaling process, the water container must be rinsed out and re-filled with fresh water. The condensate container needs to be emptied.

- Switch the steam oven on and select Maintenance  | Descale.

The message *Please wait* will appear on the display. The descaling process is being prepared. This may take several minutes. As soon as the appliance is ready, you will be prompted to add descaling agent to the water container.

- Fill the water container with lukewarm water up to the level marker  and add 2 Miele descaling tablets.
- Wait until the descaling tablets have dissolved.
- Push the water container into the appliance.
- Confirm with *OK*.
- Empty the condensate container.
- Confirm with *OK*.

The time remaining appears on the display. The descaling process will now begin.

Do not switch the steam oven off during the descaling process, otherwise the whole process will have to be started from the beginning again.

The water container will need emptying and refilling with fresh tap water twice during descaling. The condensate container needs to be emptied.

- Follow the instructions on the display.
- Confirm each time with *OK*.

Once the time left has elapsed, *Empty the condensate container* will appear.

- Follow the instructions in the display.
- Confirm with *OK*.

The descaling process is complete.

- Remove the water container and condensate container and empty them as required.
- Clean and dry the water container and condensate container.
- Open the door and let the oven compartment cool down.
- Then dry the oven compartment.
- Leave the appliance door open until the oven compartment is completely dry.
- Switch the steam oven off.

Cleaning and care

Door removal

- Prepare a suitable underlay for the door, such as a soft cloth.
- Open the door a fraction.

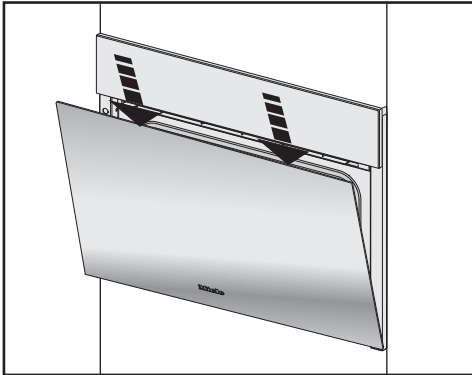

- Using both hands press down on the top edge of the door briefly.

The oven door is connected to the door hinges by retainers. Before removing the door from the retainers, the locking clamps on both door hinges have to be released.

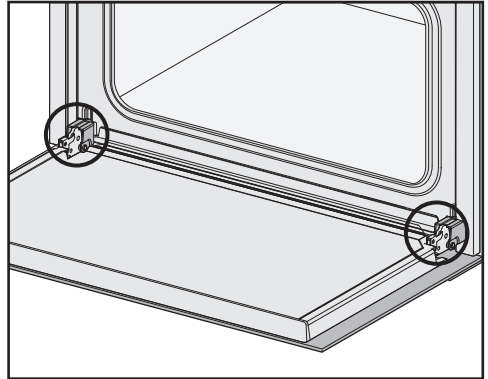

- Open the door fully.

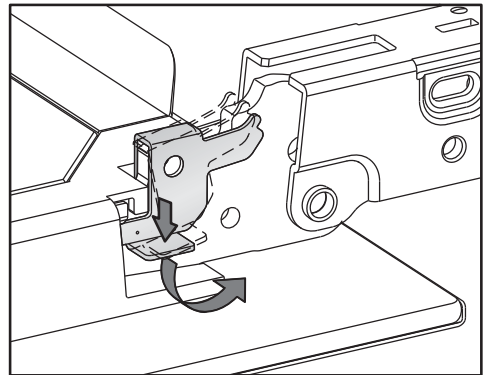

- Release the locking clamps on the hinges by turning them upwards as far as they will go until they are at an angle.

The steam oven could become damaged if you incorrectly remove the door.

Never pull the door horizontally off its retainers, as they will spring back against the steam oven.

- Raise the door up until it rests partially open.

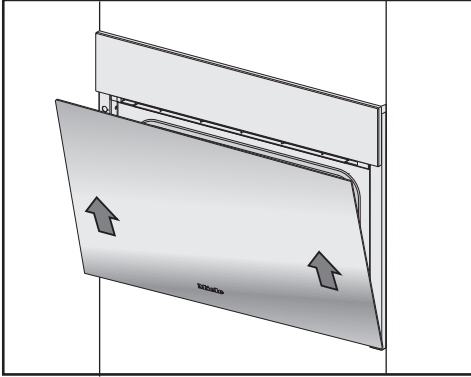

- Hold the door securely at both sides and lift it evenly upwards off the hinge retainers. Make sure that the door is straight.
- Place the door on the previously prepared surface.

Fitting the door

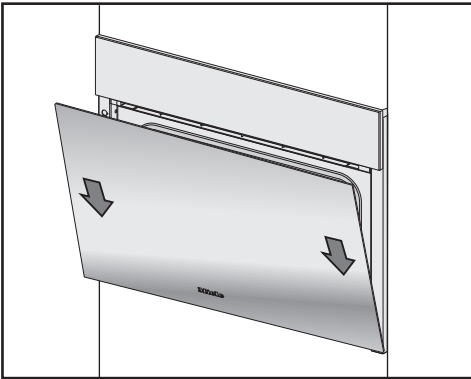

- Hold the door securely on both sides and carefully fit it back into the door hinge retainers. Make sure that you fit the door straight.
- Open the door fully.

If the locking clamps are not locked, the door could become loose, resulting in damage.

Always ensure that the locking clamps are locked after refitting the door.

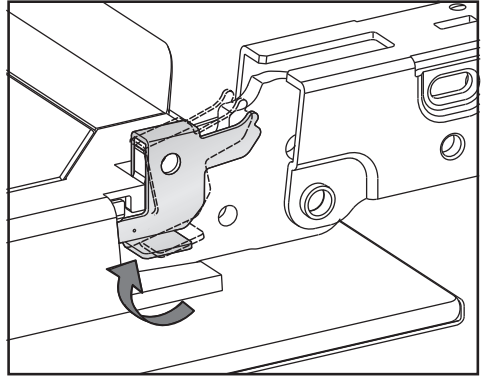

- To relock the locking clamps, turn them back up to the horizontal position as far as they will go on both door hinges.

Problem solving guide

Many malfunctions and faults that can occur in daily operation can be easily remedied. Time and money will be saved because a service call will not be needed.

The following guide may help you to find the reason for a malfunction or a fault, and to correct it.

Problem	Cause and remedy
<p>You cannot switch the appliance on.</p>	<p>The fuse has tripped.</p> <ul style="list-style-type: none"> ■ Reset the trip switch in the fuse box or replace the fuse in the plug (see data plate for minimum fuse rating).
	<p>There may be a technical fault.</p> <ul style="list-style-type: none"> ■ Disconnect the appliance from the mains connection for approximately 1 minute by: <ul style="list-style-type: none"> – Tripping the relevant mains fuse or unscrewing the fuse completely, or – Switching off the residual current protection device ■ If, after resetting the trip switch in the mains fuse box or the residual current protection device, the steam oven will still not turn on, contact a qualified electrician or Miele Service.
<p>The oven compartment does not heat up.</p>	<p>Demo mode is active. The steam oven can be operated, however, the heating elements will not work.</p> <ul style="list-style-type: none"> ■ Deactivate demo mode (see “Settings – Show-room programme”).
	<p>The oven compartment has been warmed up by a warming drawer in operation underneath it.</p> <ul style="list-style-type: none"> ■ Open the door and let the oven compartment cool down.
<p>The fan can still be heard after the appliance has been switched off.</p>	<p>The fan is still running. The appliance is fitted with a fan which removes steam from the oven. The fan will continue to run for a while after the appliance has been switched off. It will switch itself off automatically after a while.</p>

Problem	Cause and remedy
<p>The sensor controls or the movement sensor do not respond.</p>	<p>You have selected the Display QuickTouch Off setting. When this is activated, the sensor controls and movement sensor do not respond when the steam oven is switched off.</p> <ul style="list-style-type: none"> ■ As soon as the steam oven is switched on, the sensor controls and the movement sensor will respond. If you want the sensor controls and the movement sensor to respond even when the steam oven is switched off, select the Display QuickTouch On setting.
	<p>The settings for the movement sensor are switched off.</p> <ul style="list-style-type: none"> ■ Change the settings for the movement sensor by selecting Settings Movement sensor.
	<p>The movement sensor is defective.</p> <ul style="list-style-type: none"> ■ Call the Miele Customer Service Department.
	<p>The steam oven is not connected to the power supply.</p> <ul style="list-style-type: none"> ■ Check that the steam oven plug is correctly inserted into the socket. ■ Check whether the fuse has tripped. Contact a qualified electrician or the Miele Customer Service Department.
	<p>If the display does not respond, there is a fault with the controls.</p> <ul style="list-style-type: none"> ■ Touch and hold the  On/Off sensor control until the display switches off and the steam oven restarts.

Problem solving guide

Problem	Cause and remedy
<p>The door cannot be opened.</p>	<p>You have selected the Display QuickTouch Off setting. The  sensor control does not respond when the steam oven is switched off.</p> <ul style="list-style-type: none"> ■ As soon as the steam oven is switched on, the sensor controls will respond. If you want the sensor controls to always respond even when the steam oven is switched off, select the Display QuickTouch On setting. <p>There may be a technical fault.</p> <ul style="list-style-type: none"> ■ If you need to open the door, e.g. because there is still food in the oven compartment, you will need to open the door manually (see end of this chapter). ■ If the problem occurs again, contact Miele Service.
<p>A humming sound can be heard during operation and after switching off the steam oven.</p>	<p>This noise does not indicate incorrect operation or an appliance fault. The noise is made by water being pumped through the system.</p>
<p>After moving house, the steam oven no longer switches from the heating-up phase to the cooking phase.</p>	<p>The boiling temperature of the water has changed as the altitude of the new location for the appliance differs from the old one by at least 300 m.</p> <ul style="list-style-type: none"> ■ To adjust the boiling temperature, you need to de-scale the appliance (see “Care” in the “Cleaning and care” chapter).
<p>During operation an unusually large amount of steam escapes, or steam escapes from parts of the oven where it does not usually.</p>	<p>The door is not properly closed.</p> <ul style="list-style-type: none"> ■ Close the door. <p>The door seal is not correctly fitted.</p> <ul style="list-style-type: none"> ■ Press it in all the way round the door to make sure it is fitted evenly. <p>The door seal is damaged, e.g. cracks can be seen.</p> <ul style="list-style-type: none"> ■ Replace the door seal. This can be ordered from Miele (see the end of this booklet for contact details).
<p>The oven interior lighting is not working.</p>	<p>The lamp is defective.</p> <ul style="list-style-type: none"> ■ Call Miele Service to have the lamp replaced.

Problem solving guide

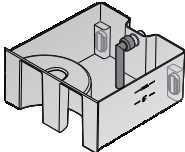
Problem	Cause and remedy
<p>The control panel will not open or close automatically despite touching the  sensor several times.</p>	<p>Something is obstructing the control panel.</p> <ul style="list-style-type: none"> ■ Remove the obstruction. <p>The obstruction sensor is very sensitive and can prevent the panel opening or shutting if it picks up a signal.</p> <ul style="list-style-type: none"> ■ Open/close the control panel manually (see end of this section) ■ If the problem occurs again, contact Miele Service.
<p>The Start at and Finish at functions are not available.</p>	<p>The temperature in the oven compartment is too high, e.g. after a programme has finished.</p> <ul style="list-style-type: none"> ■ Open the door and let the oven compartment cool down. <p>These functions are not generally available in maintenance programmes.</p>
<p>Cakes and biscuits are not cooked properly after following the durations given in the recipe.</p>	<p>The temperature set is not the same as the one given in the recipe.</p> <ul style="list-style-type: none"> ■ Change the temperature. <p>The recipe has been altered. For example, adding more liquid or eggs can increase the cooking duration required.</p> <ul style="list-style-type: none"> ■ Adapt the temperature and/or cooking duration to the altered recipe.
<p>Cakes or biscuits are unevenly browned.</p>	<p>The set temperature was too high.</p> <p>More than two levels were used for baking.</p> <ul style="list-style-type: none"> ■ Bake on a maximum of two levels.
<p>F10</p>	<p>The suction tube in the water container</p> <ul style="list-style-type: none"> – is not fitted correctly. – is not positioned vertically. <ul style="list-style-type: none"> ■ Connect it properly and make sure it is vertical: 

Problem solving guide

Problem	Cause and remedy
F11 F20	<p>The drain hoses are blocked.</p> <ul style="list-style-type: none"> ■ Descal the steam oven (see “Care” in the “Cleaning and care” chapter). ■ If the fault message appears again, contact Miele Service.
F44	<p>Communication fault</p> <ul style="list-style-type: none"> ■ Switch the steam oven off and then back on again after a few minutes. ■ If the same message appears again, call the Service Department.
F55	<p>The maximum operating time for a cooking function has been exceeded. This has triggered the safety switch off device.</p> <ul style="list-style-type: none"> ■ Switch the steam oven off and then back on again. <p>The steam oven is immediately ready for use again.</p>
F196	<p>There is a fault.</p> <ul style="list-style-type: none"> ■ Switch the steam oven off and then back on again.
	<p>The filter in the bottom of the oven compartment is not positioned correctly.</p> <ul style="list-style-type: none"> ■ Switch the steam oven off. <div style="text-align: center;">  </div> <ul style="list-style-type: none"> ■ Insert the filter correctly: ■ Switch the steam oven back on again. ■ If the fault message appears again, call Miele Service.
F and other fault codes	<p>Technical fault.</p> <ul style="list-style-type: none"> ■ Switch the appliance off and contact Miele.

To open the panel manually

- Carefully open the appliance door.

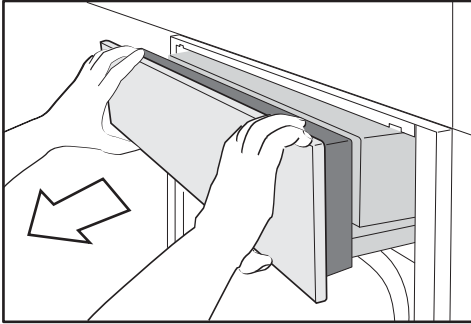

- Take hold of the panel at the top and bottom.
- Pull the panel out forwards to start with.
- Then carefully push the panel upwards.

To close the panel manually

- Take hold of the panel at the top and bottom.
- Carefully push the panel downwards.

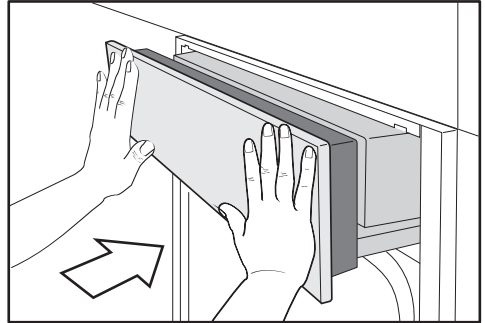

- Then push it in.

Problem solving guide

Opening the door manually

⚠ Risk of injury caused by hot surfaces.

The door glass can get hot. You can burn yourself on the door glass.

Wear oven gloves when opening the hot door.

⚠ Risk of injury caused by steam.

When using a cooking programme involving steam, a lot of steam can escape if the door is opened. The steam can cause burns.

Step back and wait until the steam has dissipated before taking the food out of the oven.

⚠ Risk of injury caused by hot surfaces and food.

The steam oven gets hot during operation. You could burn yourself on the heater elements, oven compartment, side runners, accessories, food or door glass.

Wear oven gloves when placing hot food in the oven or removing it, when adjusting oven shelves etc. in the hot oven compartment and when closing the hot door.

Wear oven gloves when taking hot food out of the oven, when adjusting oven shelves etc. in a hot oven compartment and when closing the hot door.

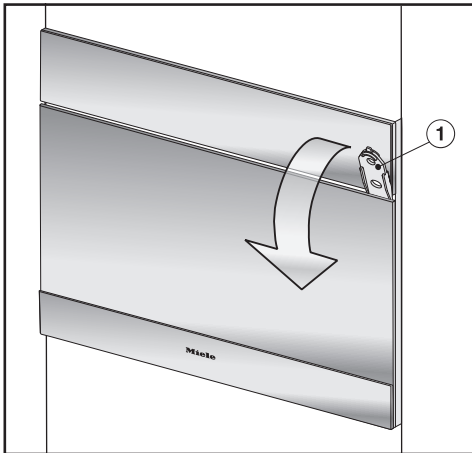

- Insert the opener supplied ① about 3 cm into the gap between the door and the control panel on the right hand side and then pull the door open.

Miele offer a comprehensive range of useful accessories as well as cleaning and conditioning products for your Miele appliances.

These products can be ordered through the Miele Webshop.

They can also be ordered from Miele (see end of this booklet for contact details) or from your Miele dealer.

Containers

Miele offers a wide range of cooking containers. These have all been optimised for Miele appliances in terms of functionality and dimensions. Detailed information on each of our products can be found on the Miele website.

- Perforated cooking containers in various sizes
- Solid cooking containers in various sizes
- Gourmet oven dishes in various sizes
- Lids for Gourmet oven dishes

Other

- Baking trays
- Round baking tray
- FlexiClip runners
- Holding rack for cooking containers with a width of 325 mm

Cleaning and care products

- DGClean
Special cleaning agent for removing stubborn soiling from the oven compartment, particularly after roasting
- Descaling tablets (6)
- All-purpose microfibre cloth
For removing finger marks and light soiling

Service

Contact in the event of a fault

In the event of any faults which you cannot remedy yourself, please contact your Miele dealer or the Miele Customer Service Department.

You can book a Miele Customer Service Department call-out online at www.miele.com/service.

Contact information for the Miele Customer Service Department can be found at the end of this document.

Please quote the model identifier and serial number of your appliance (Fabr./SN/Nr.) when contacting the Miele Customer Service Department. This information can be found on the data plate.

Please note that telephone calls may be monitored and recorded for training purposes and that a call-out charge will be applied to service visits where the problem could have been resolved as described in this booklet.

This information is given on the data plate, which is visible on the front frame of the oven when the door is fully open.

Warranty

For information on the appliance warranty specific to your country please contact Miele. See back cover for address.

In the UK, your appliance warranty is valid for 2 years from the date of purchase. However, you must activate your cover by calling 0330 160 6640 or registering online at www.miele.co.uk.

Safety instructions for installation

 Risk of damage from incorrect installation.

Incorrect installation can cause damage to the steam oven.

The steam oven must only be installed by a qualified person.

▶ The connection data (frequency and voltage) on the steam oven's data plate absolutely must correspond with those of the electricity supply in order to ensure that no damage can occur to the steam oven.

Compare this data before connecting the appliance. If in any doubt, consult a qualified electrician.

▶ Multi-socket adapters and extension leads do not guarantee the required safety of the appliance (fire hazard). Do not use them to connect the steam oven to the power supply.

▶ The socket should be easily accessible after the steam oven has been installed.

▶ The steam oven must be positioned so that you can see the contents of a cooking container placed on the top shelf level. Otherwise there is a risk of injuries or spillages of hot food.

Installation

Building-in dimensions

All dimensions are given in mm.

Installation in a tall unit

The furniture housing unit must not have a back panel fitted behind the building-in niche.

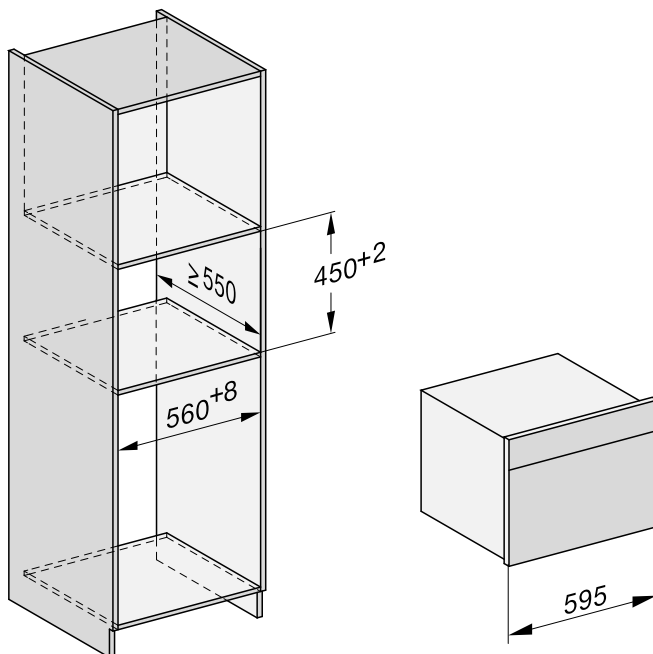

Installation in a base unit

The furniture housing unit must not have a back panel fitted behind the building-in niche.

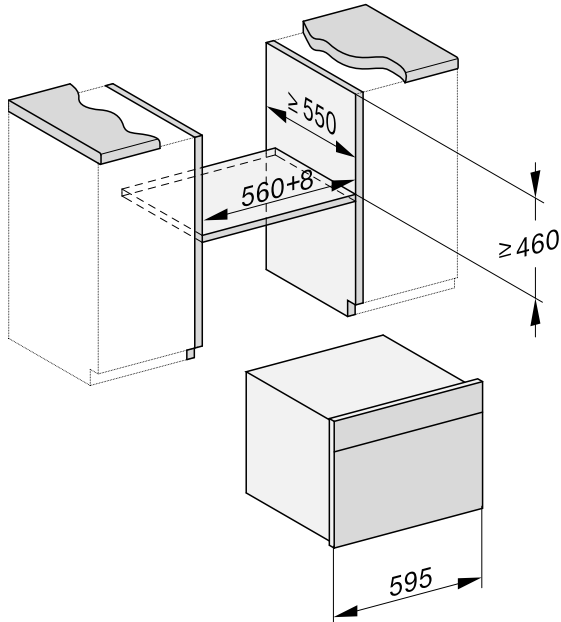

Installation

Side view

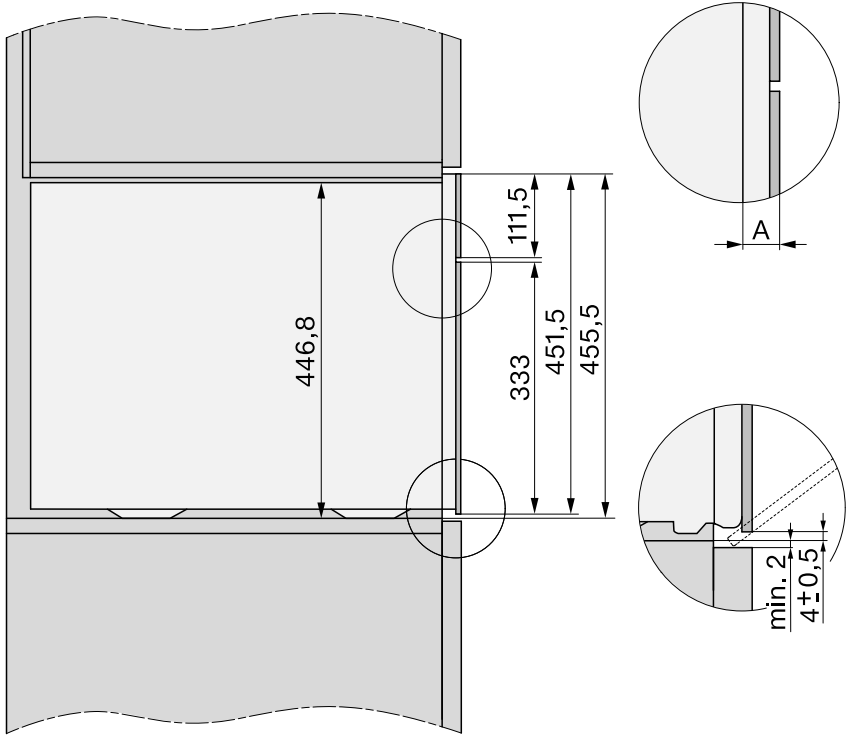

- A** Glass front: 22 mm
Metal front: 23.3 mm

Swivel range for control panel

The area in front of the control panel must not be blocked by anything (such as a door handle) that would hinder it from opening and shutting.

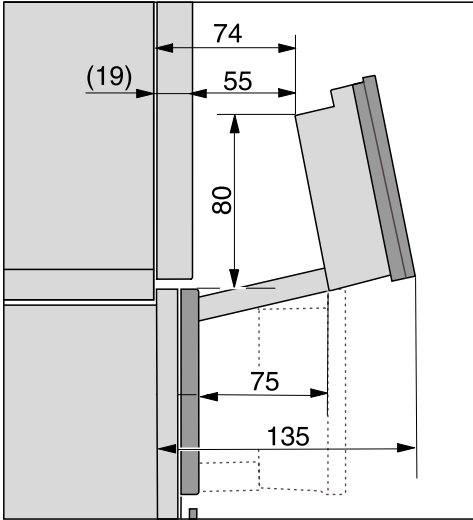

Installation

Connection and ventilation

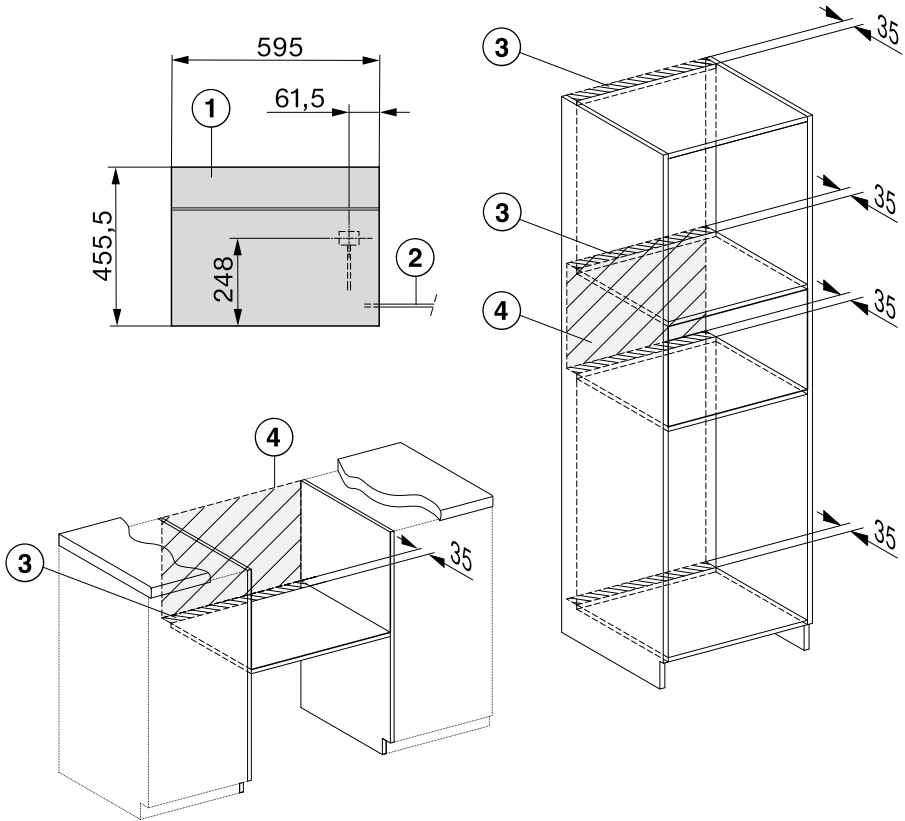

- ① Front view
- ② Mains connection cable, L = 2000 mm
- ③ Ventilation cut-out, min. 180 cm²
- ④ No connections permitted in this area

Installing the steam oven

- Connect the mains connection cable to the steam oven.

Use the handle cut-outs on the side of the casing to lift the steam oven.

The steam generator may malfunction if the steam oven is not on a level surface.
The maximum deviation from the horizontal that can be tolerated is 2°.

- Push the steam oven into the building-in niche and align it.
When doing so make sure that the mains connection cable does not get trapped or damaged.
- Open the door.

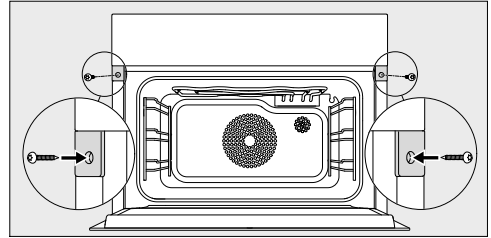

- Secure the steam oven to the side walls of the unit using the wood screws supplied (3.5 x 25 mm).
- Connect the steam oven to the electricity supply.
- Check all functions of the steam oven are working correctly in accordance with the operating instructions.

Installation

Electrical connection

We recommend that you connect the steam oven to the power supply using a suitable switched electrical socket. This makes it easier to perform servicing work. The socket must be easily accessible after the steam oven has been installed.



Risk of damage from incorrect connection.

Installation, repairs and other maintenance work by unqualified persons could be dangerous. Miele cannot be held liable for unauthorised work.

Miele cannot be held liable for damage or injury caused by the lack of or inadequacy of an on-site earthing system (e.g. electric shock).

If the plug is removed from the connection cable or if the cable is supplied without a plug, the steam oven must be connected to the electrical supply by a suitably qualified electrician.

If the socket is no longer accessible, or if a hard-wired connection is installed, an additional means of disconnection must be provided for all poles. A suitable means of disconnection would include switches with an all-pole contact gap of at least 3 mm. These include circuit breakers, fuses and contactors. The required connection data is provided on the data plate. Please ensure that these details match the electrical supply.

After installation, ensure that all electrical components are shielded and cannot be accessed by users.

Total power rating

See data plate

Connection data

The connection data is quoted on the data plate. Please ensure these match the household mains supply.

Residual current device

For extra safety, it is advisable to protect the steam oven with a suitable residual current device (RCD) with a trip range of 30 mA.

Replacing the mains connection cable

When replacing the mains connection cable, please use cable type H 05 VV-F with a suitable cross-section. These cables are available from the manufacturer or from Miele Service.

Disconnecting from the mains

 Risk of electric shock from mains voltage.

There is a risk of electric shock if the appliance is reconnected to the mains supply during repair or service work.

After disconnection, ensure the appliance cannot be switched back on by mistake.

To disconnect the appliance from the mains power supply, do one of the following depending on installation:

Safety fuses

- Completely remove the fuse links from the screw caps.

Automatic circuit breakers

- Press the test button (red) until the middle button (black) springs out.

Built-in circuit breakers

- For circuit breakers of at least type B or C, switch the lever from 1 (on) to 0 (off).

Residual current device (RCD)

- Residual current device: switch the main switch from 1 (on) to 0 (off) or press the test button.

Conformity declaration

Miele hereby declares that this Combi steam oven complies with Directive 2014/53/EU.

The complete text of the EU declaration of conformity is available from one of the following internet addresses:

- Products, Download from www.miele.co.uk
- For service, information, operating instructions etc: go to www.miele.co.uk/domestic/customer-information-385.htm and enter the name of the product or the serial number

Frequency band of the WiFi module	2,4000 GHz – 2,4835 GHz
-----------------------------------	-------------------------

Maximum transmission power of the WiFi module	< 100 mW
---	----------

Frequency band of the food probe	433,2 MHz – 434,6 MHz
----------------------------------	-----------------------

Maximum transmission power of the food probe	< 10 mW
--	---------

Miele uses their own and third party software which is not subject to any so-called Open Source Licence for the operation and control of the appliance. This software/ these software components are protected by copyright. The copyright powers of Miele and third parties have to be respected.

Furthermore, this appliance contains software components which are distributed under Open Source licence conditions. Please refer to [Settings | Legal information | Open Source licences](#) in the appliance for the Open Source components contained therein, together with the corresponding copyright notices, copies of the licence terms valid at the time, and any further information. The liability and warranty provisions of the Open Source licence terms and conditions as stated therein apply only in relation to the respective rights holders.

In particular, the appliance contains software components licenced by the copyright holders under the GNU General Public License, Version 2, or the GNU Lesser General Public License, Version 2.1. For a period of at least 3 years from the date of purchase or delivery of the appliance respectively, Miele offers to provide you or third parties with a machine-readable copy of the source code of the Open Source components contained in the appliance and licenced under the terms of the GNU General Public License, Version 2, or the GNU Lesser General Public License, Version 2.1, on a data carrier (CD-ROM, DVD or USB stick). Please contact us via e-mail (info@miele.com) or the below postal address and state the product name, the serial number and the date of purchase to obtain this source code.

Miele & Cie. KG
Open Source
GTZ/TIM
Carl-Miele-Straße 29
33332 Gütersloh

Please note the limited warranty in favour of the rights holders under the terms of the GNU General Public License, Version 2, and the GNU Lesser General Public License, Version 2.1:

This program is distributed in the hope that it will be useful, but WITHOUT ANY WARRANTY, without even the implied warranty of MERCHANTABILITY of FITNESS FOR A PARTICULAR PURPOSE. See the GNU General Public License and GNU Lesser General Public License for more details.

United Kingdom

Miele Co. Ltd., Fairacres, Marcham Road, Abingdon, Oxon, OX14 1TW

Tel: 0330 160 6600, Internet: www.miele.co.uk/service, E-mail: info@miele.co.uk

Australia

Miele Australia Pty. Ltd.
ACN 005 635 398
ABN 96 005 635 398
1 Gilbert Park Drive
Knoxfield, VIC 3180
Tel: 1300 464 353
Internet: www.miele.com.au

China Mainland

Miele Electrical Appliances Co., Ltd.
1-3 Floor, No. 82 Shi Men Yi Road
Jing' an District
200040 Shanghai, PRC
Tel: +86 21 6157 3500
Fax: +86 21 6157 3511
E-mail: info@miele.cn,
Internet: www.miele.cn

Hong Kong, China

Miele (Hong Kong) Ltd.
41/F - 4101, Manhattan Place
23 Wang Tai Road
Kowloon Bay, Hong Kong
Tel: (852) 2610 1025
Fax: (852) 3579 1404
Email:
customerservices@miele.com.hk
Website: www.miele.hk

India

Miele India Pvt. Ltd.
Ground Floor, Copia Corporate Suites
Plot No. 9, Jasola
New Delhi - 110025
Tel: 011-46 900 000
Fax: 011-46 900 001
E-mail: customercare@miele.in
Internet: www.miele.in

Ireland

Miele Ireland Ltd.
2024 Bianconi Avenue
Citywest Business Campus
Dublin 24
Tel: (01) 461 07 10
Fax: (01) 461 07 97
E-Mail: info@miele.ie
Internet: www.miele.ie

Malaysia

Miele Sdn Bhd
Suite 12-2, Level 12
Menara Sapura Kencana
Petroleum
Solaris Dutamas No. 1
Jalan Dutamas 1
50480 Kuala Lumpur, Malaysia
Phone: +603-6209-0288
Fax: +603-6205-3768

New Zealand

Miele New Zealand Limited
IRD 98 463 631
8 College Hill
Freemans Bay, Auckland 1011
New Zealand
Tel: 0800 464 353
Internet: www.miele.co.nz

Singapore

Miele Pte. Ltd.
29 Media Circle
#11-04 ALICE@Mediapolis
Singapore 138565
sTel: +65 6735 1191
Fax: +65 6735 1161
E-Mail: info@miele.com.sg
Internet: www.miele.sg

South Africa

Miele (Pty) Ltd.
63 Peter Place
Bryanston 2194
P.O. Box 69434
Bryanston 2021
Tel: (011) 875 9000
Fax: (011) 875 9035
E-mail: info@miele.co.za
Internet: www.miele.co.za

Thailand

Miele Appliances Ltd.
BHIRAJ TOWER at EmQuartier
43rd Floor Unit 4301-4303
689 Sukhumvit Road
North Klongton Sub-District
Vadhana District
Bangkok 10110, Thailand

United Arab Emirates

Miele Appliances Ltd.
Showroom 1
Eiffel 1 Building
Sheikh Zayed Road, Umm Al Sheif
P.O. Box 114782 - Dubai
Tel. +971 4 3044 999
Fax. +971 4 3418 852
800-MIELE (64353)
E-Mail: info@miele.ae
Website: www.miele.ae

Manufacturer: Miele & Cie. KG, Carl-Miele-Straße 29, 33332 Gütersloh, Germany

DGC 7840 X

en-GB

M.-Nr. 11 181 100 / 02