

FISHER & PAYKEL

VENTED CLOTHES DRYER

DE7060M, DE6060M,
DE5060M & DE4560M models

INSTALLATION GUIDE / USER GUIDE

NZ AU SG ROW

CONTENTS

Introduction	3
Safety and warnings	4
Installation instructions	7
Getting started quickly	16
Dryer controls	18
Sorting and loading	19
Drying cycles	22
Drying cycle options	25
Cleaning your dryer	28
Before you call for service	29
Troubleshooting	30
Manufacturer's Warranty	34
Customer Care	36

IMPORTANT!

SAVE THESE INSTRUCTIONS

The models shown in this user guide may not be available in all markets and are subject to change at any time. For current details about model and specification availability in your country, please go to our website fisherpaykel.com or contact your local Fisher & Paykel dealer.

Registration

Register your product with us so we can provide you with the best service possible.

To register your product visit our website: fisherpaykel.com

INTRODUCTION

Welcome to your Fisher & Paykel vented dryer.

Thank you for purchasing a Fisher & Paykel clothes dryer. We are proud of this dryer and trust it will serve you well for many years.

At Fisher & Paykel we aim to provide innovative products that are simple to use, ergonomic, energy efficient and kind to the environment. Thousands of tonnes of laundry and 80 years of laundry experience have been programmed into your dryer to help give you the best possible performance.

Your new dryer gives you the convenience of tumble drying and your clothes the advantage of not being subjected to the harsh overdrying effects of the sun. Your clothes will feel softer, retain their shape better and require less ironing. This dryer has been specifically designed to complement our front loading and top loading Fisher & Paykel washers.

All of our dryers have the ability to automatically sense when your clothes are dry, meaning your dryer is more efficient, making it kinder on your wallet and the environment.

Please take the time to read these instructions carefully before you begin using your dryer. Following the advice in this user guide will ensure you get the performance you expect from your dryer and that you get the best possible results. Keep these instructions for future reference and pass them on with your dryer, if it changes hands.

We hope you enjoy your new dryer. We have certainly enjoyed designing it for you.

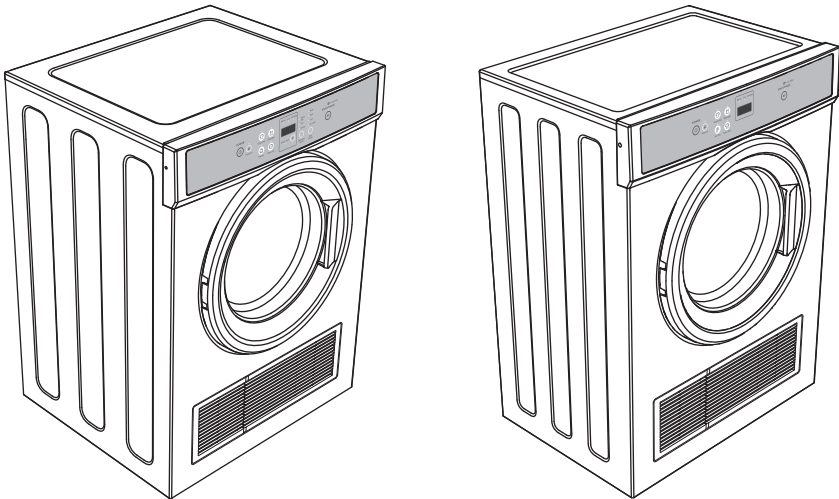

Vented clothes dryer

SAFETY AND WARNINGS

Meaning of symbols on the dryer



Warning: Risk of fire/Flammable materials



Read the instructions

WARNING!



Fire Hazard

- Only dry fabrics that have been washed with water.
- Do not use heat to dry articles containing foam rubber or similarly textured rubber-like materials, dry on 'Air Dry'.
- Do not stop a tumble clothes dryer before the end of the drying cycle unless all items are removed and spread out, in order to dissipate the heat.
- A clothes dryer produces combustible lint; the lint filter must be cleaned before each drying cycle.
- Failure to follow the warnings outlined in these user instructions can cause a fire hazard.
- Failure to follow these instructions can result in death or personal injury.

IMPORTANT SAFETY INSTRUCTIONS

WARNING! When using this appliance always exercise basic safety precautions including the following:

Dryer use

- The tumble dryer is intended only for drying textile material washed in water.
- Undergarments that contain metal reinforcements should not be placed in the dryer. Damage to the dryer can result if the metal reinforcements come loose during drying. If you wish to dry these items use a drying rack or place in a garment bag.
- Check and remove all objects from pockets, eg lighters and matches.
- Never dry rubber articles, or any plastic items or film, eg plastic lined tablecloths and baby bibs.
- Clothes should go through the cool down/airing phase in the final part of the cycle. This ensures items are left at a temperature where they will not be damaged. If for any reason the dryer is stopped before the cycle has finished, dry clothes should be removed immediately and not left in the dryer. Clothes should be quickly spread out flat to cool so heat can dissipate, not left bunched up, eg in a clothes basket.
- This dryer has been designed for domestic use only, not for commercial applications, such as massage/beauty clinics where there may be increased lint accumulation or flammable materials in the atmosphere or load.
- Do not operate this product without the lint filter in place or allow lint to accumulate in or around the dryer.
- This dryer is not intended for use by persons (including children) with reduced physical, sensory or mental capabilities, or lack of experience and knowledge, unless given supervision or instruction concerning the use of the dryer by a person responsible for their safety.

SAFETY AND WARNINGS

- Children should be supervised to ensure they do not play with the dryer.
- Unplug the machine from the power supply when it is not in use.
- Do not swing on or put weight on the door.
- Your dryer is designed to stop operating in the event of power outage. When power is resumed, the machine will remain off until the 'POWER' ⓐ button is pressed. To restart the dryer, press 'POWER' ⓐ, select your drying cycle and press ▶||.
- Never attempt to repair the dryer yourself.
- The only user-removable part of the dryer is the lint filter. No other parts are designed to be removed by anyone other than a Fisher & Paykel trained and supported service technician.
- For problems that cannot be solved from information in this User Guide, turn off and unplug your dryer and contact a Fisher & Paykel trained and supported service technician.
- When disposing of the dryer, it is recommended that the door is removed to avoid children getting trapped inside, and that the electrical cable is cut off close to the dryer.

IMPORTANT!

We do not recommend the use of extension cords or portable electrical outlet devices for safety reasons.

Lint

- Accumulated lint in the dryer can become a fire hazard; it also reduces the efficiency of the dryer by causing longer drying times and increased power consumption.
- Clean the lint filter before every load.
- Ensure the area around the dryer is clear of lint.
- At regular intervals have the interior of the dryer cleaned of any accumulated lint. This must be done by a Fisher & Paykel trained and supported service technician. This must be done when the dryer installation is changed from free standing or inverted, or vice versa.
- The dryer exhaust ducting should be inspected and cleaned periodically to remove accumulated lint.

Spontaneous combustion

IMPORTANT!

To reduce the risk of fire in a tumble dryer the following should be observed:

- Items that have been spotted or soaked with vegetable oil or cooking oil are a fire hazard and should not be placed in a tumble dryer.
- Oil-affected items can ignite spontaneously, especially when exposed to heat sources such as a tumble dryer. The items become warm causing an oxidation reaction in the oil. This oxidation creates heat. If the heat cannot escape the items can become hot enough to catch fire. Piling, stacking or storing oil-affected items can prevent heat from escaping creating a fire hazard.
- If it is unavoidable that fabrics that contain vegetable oil, cooking oil or have been contaminated by hair care products be placed in a tumble dryer, they should first be washed in hot water with extra detergent - this will reduce, but not eliminate the fire hazard. The cool down cycle of the dryer should be used to reduce the temperature of these items. They should not be removed from the tumble dryer and piled or stacked while hot.

SAFETY AND WARNINGS

- **Items that have previously been cleaned in, washed in, soaked in or spotted with flammable liquids or solids, eg petrol/gasoline, kerosene, dry cleaning solvents, vegetable or cooking oil, acetone, denatured alcohol, some brands of spot removers, turpentine, waxes and wax removers or other flammable or explosive substances should not be placed in a tumble dryer.**
- **Do not dry unwashed items in the tumble dryer.**
- **The dryer is not to be used if industrial chemicals have been used for cleaning.**
- **Fabric Softeners or similar products should not be used in a tumble dryer to eliminate the effects of static electricity, unless this practice is specifically recommended by the manufacturer of the fabric softener product.**
- **Rubber backed articles, foam rubber (latex foam), clothes or pillows fitted with foam rubber pads, fibreglass, shoes containing rubber, shower caps, babies waterproof napkin covers and waterproof textiles should not be dried in the dryer. These materials can when heated produce fire by spontaneous combustion.**
- **The maximum mass of dry textiles depends on your model. The DE7060M model is rated at 7kg. The DE6060M model is rated at 6kg. The DE5060M model is rated at 5kg. The DE4560M model is rated at 4.5kg. Do not overload your dryer.**

INSTALLATION INSTRUCTIONS

Please read and follow the ‘Safety and warnings’ and ‘Installation instructions’ sections carefully before using your dryer!

Accessories

Please check you received the following accessories with your Fisher & Paykel dryer. You will find them inside the drum:

- 1 x Installation guide/User guide
- 1 x Wall mounting kit
- 1 x Duct adapter
- 1 x Inverted panel

Unpacking

To ensure the best performance from your new dryer please follow the instructions below.

Removing the packaging

- ① Remove the outer packaging (including the polystyrene packer and plastic wrapping). All packaging must be removed prior to use.

IMPORTANT!

- **Ensure packaging materials are kept out of reach of children.**
 - **Please help protect the environment and dispose of the packaging from around the dryer in an environmentally friendly manner.**
- ② Tilt the dryer backwards and ‘walk’ it off the base one foot at a time. Not doing so may cause damage to your floor and dryer.
 - ③ Remove all packaging and accessories from inside the drum and ensure you remove protective covers from the door and console.

Location

IMPORTANT!

- **The dryer must be installed in a well-ventilated, dust-free environment.**
- **The dryer must not be installed on any textured floor coverings (eg carpet, rugs).**
- **Do not install the dryer behind a lockable door, sliding door, or behind a door where the hinge is on the opposite side to that of the dryer in such a way that the full opening of the door is inhibited. Ensure the dryer door can always be opened fully.**
- **Do not install the dryer outside, in a damp place, where there is a risk of freezing, where it may be rained on, in direct sunlight or close to a source of heat.**
- **Do not place your dryer on top of its power cable.**

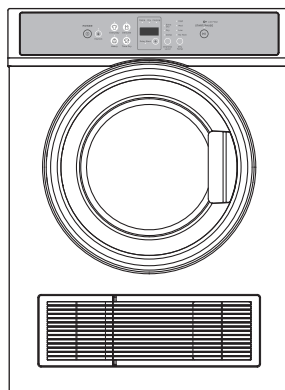

INSTALLATION INSTRUCTIONS

Venting

Correct installation is very important for all dryers to ensure maximum efficiency and safety.

IMPORTANT!

Never run the dryer unless the airflow system is free from obstruction.

There must be adequate ventilation to avoid the back flow of gases into the room from appliances burning fuels, including open fires, when operating the dryer.

Exhaust air must not be discharged into a flue which is used for exhausting fumes from appliances burning gas or other fuels.

External venting

Your dryer has been designed to be vented outside to provide the following advantages:

- Ensures optimum efficiency by preventing recirculation of moist air.
- Eliminates condensation on walls and ceilings.
- Reduces the chance of lint being sucked into the dryer.
- Prevents lint and other fine particles being blown into the room.

All external venting systems must be:

- Made from 100mm diameter flexible foil sleeved with a galvanised metal pipe where the vent system goes through the wall, or 100mm diameter galvanised metal piping.
- Exhausted outside and not into another confined space, eg the roof cavity of a house.
- Fitted with a vent cap outside to stop rain water entering the dryer exhaust system.
- Angled to avoid condensation running back into the dryer.
- The vent system should be a maximum of two metres with no more than three 90° bends.
- Vent systems over two metres long require special installation. Contact a Fisher & Paykel trained and supported service technician.

Internal venting

The dryer is set up in the factory for front venting. If front venting is used there must be adequate ventilation to avoid the build up of moisture in the room, which can affect the performance of the dryer. Venting must comply with local by-laws and regulations.

INSTALLATION INSTRUCTIONS

Installation options

There are two different ways your dryer can be positioned. Freestanding or inverted and mounted on a wall.

Free standing

The dryer stands on the floor and can easily be moved into position.

- ① Move the dryer into the desired position. Do not lift the dryer by the top panel.
- ② Have a minimum clearance on all sides of at least 20mm.
- ③ Have a minimum clearance at the rear of 75mm. The spacers from the accessory wall mounting kit can be used to set this distance.
- ④ Install the dryer on a stable and level floor.

Free standing venting options

Note: the vent system should be less than two metres long with no more than three 90° bends.

Before a rear venting option is installed the dryer must be changed from the front venting factory setup. Remove the outlet grille from the front left-hand side and replace with the outlet cover from the rear left-hand side. These covers should be gently pried at the sides to prevent damage.

External venting

The dryer is vented with a kit that can be positioned to remove air to the side.

The dryer is vented directly through the wall using a ducting kit in combination with the duct adaptor supplied with the dryer.

The dryer is vented through a window using a ducting kit in combination with the duct adaptor supplied with the dryer. This requires the dryer to be a minimum distance of 140mm from the wall to ensure the ducting is not restricted with tight bends or can be crushed.

Internal venting

Front venting is the only recommended option for venting into the room. The dryer is set up for front venting when it leaves the factory.

Note: where possible all efforts should be made to vent the dryer externally to avoid moisture build up around the dryer.

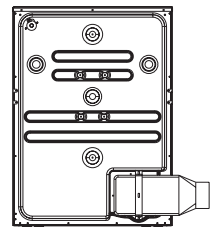

External venting with kit part number PD-DK4W

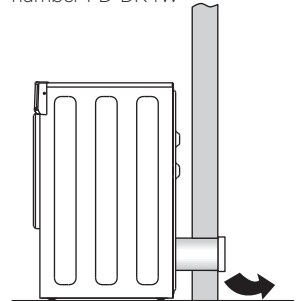

External venting with kit part number PD-SVHCW4

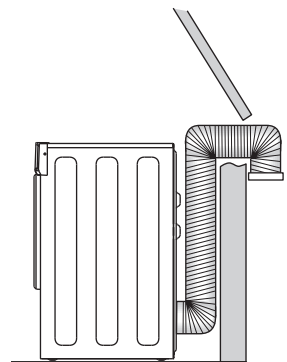

External venting with kit part number PD-FO408

Inverted wall mounting installation

Your dryer has been designed to be inverted and mounted on the wall above a washer or tub. A wall mounting kit must be used. Inverting allows access to the dryer control panel.

Tools and parts required:

- Drill and 3mm bit
- Phillips head screwdriver

Wall mounting kit includes:

- 2 x Plastic spacers
- 2 x Wall hanging brackets
- 2 x Hanging hook
- 4 x Wood screws
- 6 x Screws for hanging hooks and plastic spacers

INSTALLATION INSTRUCTIONS

Inverted wall mounting

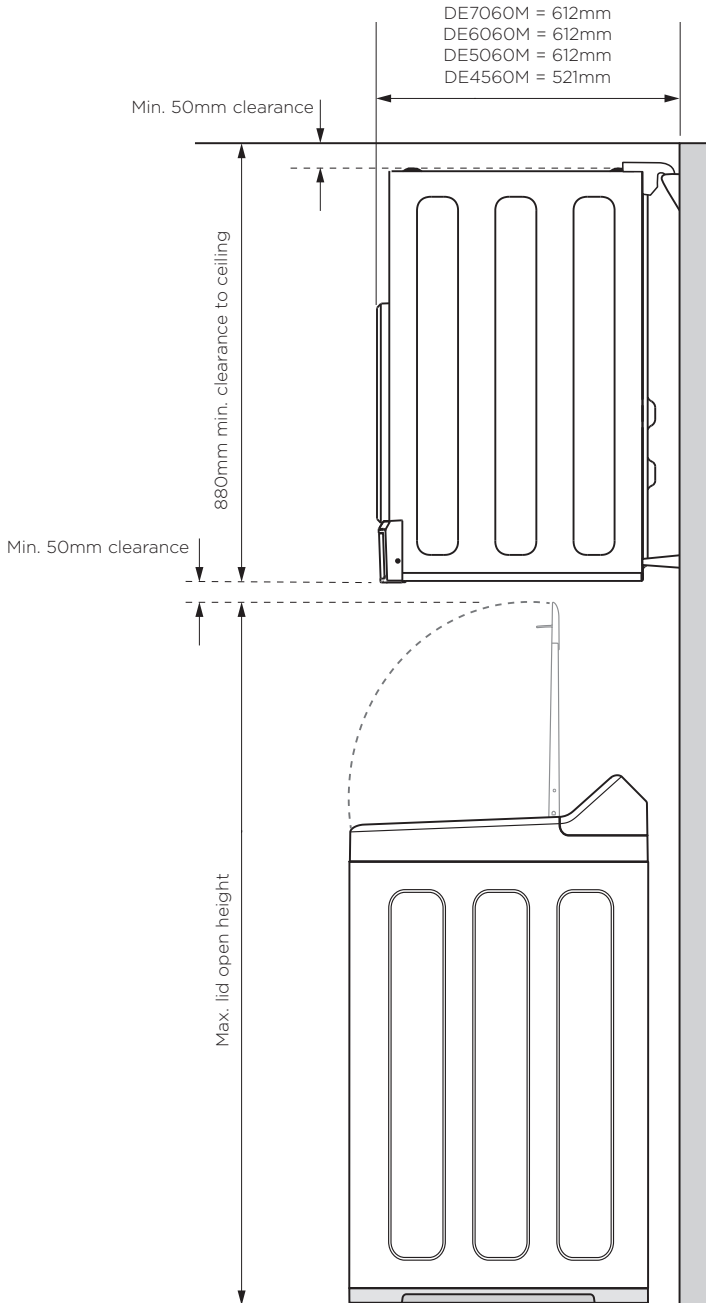

INSTALLATION INSTRUCTIONS

Mounting dryer on wall

- ① Determine the position of the dryer on the wall and mark the bracket position. A minimum of 50mm is needed between the top of the dryer and the ceiling for ease of installation. If mounting above a washing machine, allow sufficient room to open the lid of the washer. Refer to page 11 for lid clearances.
- ② Fix the wall hanging brackets to the wall securely, ie into the stud. If the studs are too far apart, fit a timber slat to the studs and then mount the brackets to the slat. If a slat is used install a second slat behind the spacers to ensure the dryer is horizontal. The distance between the centre of each bracket is 555mm (A).
- ③ To install the hooks onto the dryer, remove one screw from each side (B), reuse these screws with two more (each side) from the kit to fasten the hooks in place.
- ④ Remove plastic plugs from the back of the dryer and screw the spacers provided in place (C).
- ⑤ With assistance, mount the dryer on the wall brackets.
- ⑥ Fit inverted control panel over the existing panel.
- ⑦ Adjust the display to read correctly on an inverted panel:
 - For DE7060M, DE6060M and DE5060M press and hold the 'Keylock' and 'Heavy' buttons for three seconds.
 - For DE4560M press and hold the 'Keylock' and 'Air Dry' buttons for three seconds.
 - The dryer will beep to indicate you have made a correct selection, and the display will change after three seconds.
 - Repeat the same steps to return the panel to the factory setting.

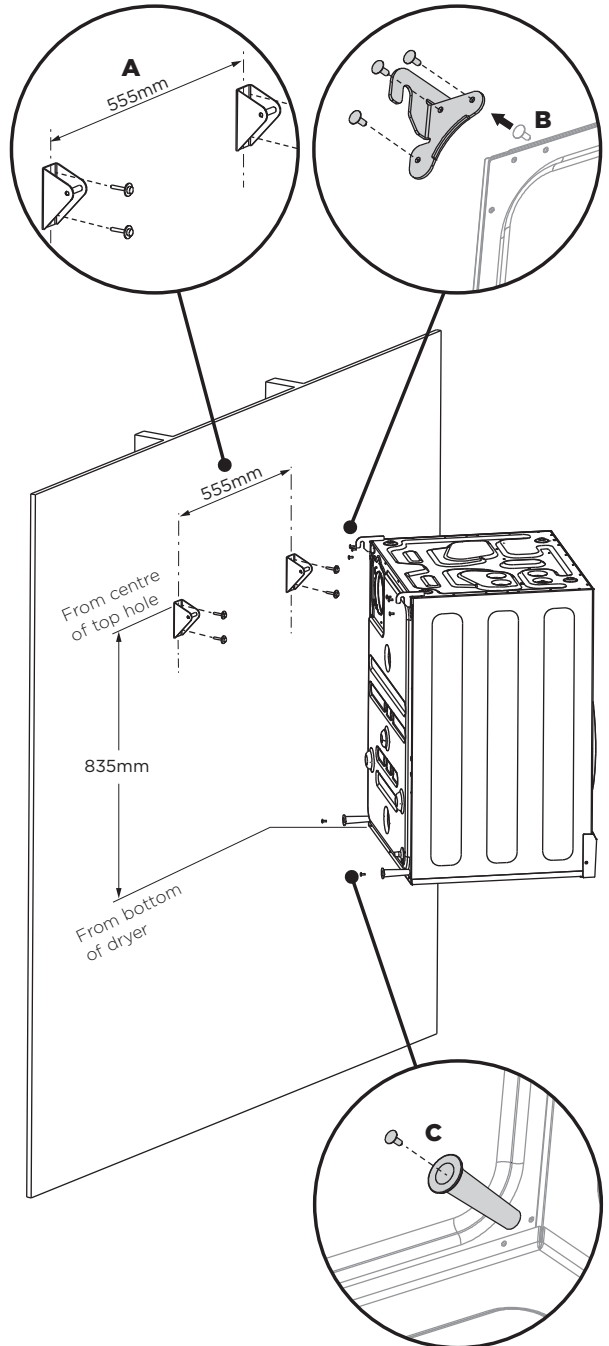

INSTALLATION INSTRUCTIONS

Before a rear venting option is installed the dryer must be changed from the front venting factory setup. Remove the outlet grille from the front left-hand side and replace with the outlet cover from the rear left-hand side. These covers should be gently pried at the sides to prevent damage.

External venting options

- Kits are available that allow the dryer to be vented upwards or to the side.
- The dryer can be vented directly through the wall with a kit, in combination with the duct adaptor supplied with the dryer.

Note: the vent system should be less than two metres long with no more than three 90° bends.

Internal venting

Front venting is the only option for internal venting. The dryer is set up for front venting when it leaves the factory.

Note: where possible all efforts should be made to vent the dryer externally to avoid moisture build up around the dryer.

Electrical connection

- ① This appliance must be connected to a 220V – 240V, 50Hz, sinusoidal, 10A electrical supply.
 - ② Uncoil the power cord, remove and discard the plastic pin cover and plug into a power socket.
 - ③ Connect the appliance to an earthed outlet protected by a fuse of suitable capacity.
- Check the power cord for damage and make sure it is not squashed or twisted when installing the dryer.
 - Always remove the power cord from the power socket by the plug, not by the cord.

IMPORTANT!

- **Do not touch or operate the dryer with wet hands or with bare feet.**
- **A damaged power cord must be replaced by a Fisher & Paykel trained and supported service technician. The appliance must not be operated until it is repaired, as there is risk of electric shock.**
- **Do not operate this dryer if it has been damaged during transport. Contact your Fisher & Paykel dealer or Fisher & Paykel trained and supported service technician.**

WARNING!

The appliance must not be supplied through an external switching device, such as a timer, or connected to a circuit that is regularly switched on and off by a utility.

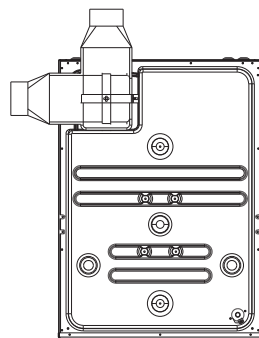

External venting with kit part number PD-DK4W

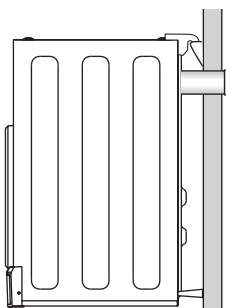

External venting with kit part number PD-SVHCW4

Completing the installation

Installation test cycle

IMPORTANT!

Ensure the installation test cycle is completed before you dry any items in your dryer. This is to check that your dryer is installed correctly and that it is functioning properly prior to use.

- ① Turn your dryer on by pressing the 'POWER' ⓘ button.
- ② Select the 'Time Dry' cycle for 30 minutes. Ensure the drum is empty and the door is closed (you will hear it click shut).
- ③ Press the ▶|| button. The drum will start rotating.
 - Observe the dryer for any problems.
 - The dryer will beep and display any faults on the screen if there are any problems. Refer to page 29.
- ④ At the completion of the cycle open the door and check that there is warmth inside the dryer. This indicates the dryer is operating normally.

IMPORTANT!

If there are any problems, you must address these before proceeding with normal use. The dryer will automatically turn off at the end of the cycle if there are no problems.

Before you start, it is a good idea to go through the following checklist:

- ① Has the packaging been removed?
- ② Is the lint filter correctly in place?
- ③ Has the power cord been connected to an appropriate power supply and the power turned on?
- ④ Have you performed the installation test cycle?

INSTALLATION INSTRUCTIONS

Product specifications

	DE4560M	DE5060M	DE6060M	DE7060M
Capacity (kg)*	4.5	5	6	7
DIMENSIONS (mm)				
Width	600	600	600	600
Depth	481	571	571	571
Height	825	825	825	825
ELECTRICAL				
Volts	220 - 240	220 - 240	220 - 240	220 - 240
Hz	50	50	50	50
Amps (maximum)	10	10	10	10
Rated Power (W)	1750	1750	1750	1770

* Capacity refers to the maximum **dry** weight of items the dryer can dry at any one time.
Rated capacity is determined by a countries performance standards, so similar dryers may have different capacities for different markets.

GETTING STARTED QUICKLY

IMPORTANT!

- Check the lint filter is clean before every load. Ensure it is replaced correctly before using your dryer.
- The lint filter indicator light will flash at the beginning of every cycle when the machine is switched on, as a reminder to check the lint filter.
- Sort and load items into the dryer drum, ensuring no items are in the way of the door.
- Close the door.

- ① Press 'POWER' ① to activate your dryer.
- ② Your dryer will default to the 'Everyday' cycle. Select your desired drying cycle by pressing the cycle button of your choice.
- ③ DE7060M, DE6060M and DE5060M models only. Select your preferred drying options, using the buttons on the right hand side of the panel (if you wish to select options different from the default options for the cycle).
- ④ Press the ►|| button to start the cycle.

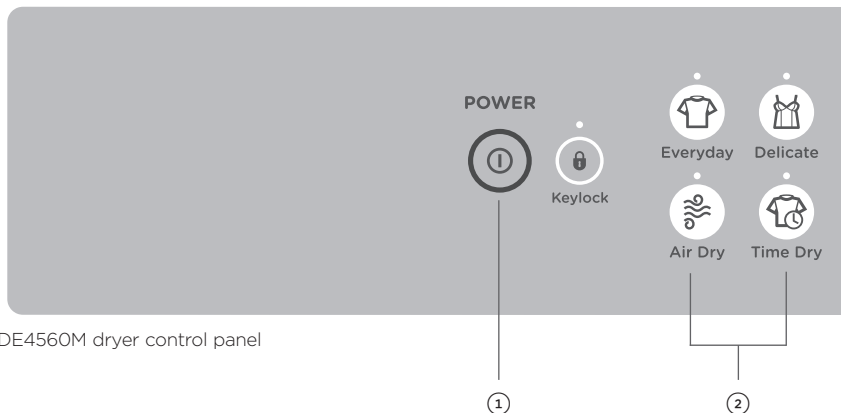
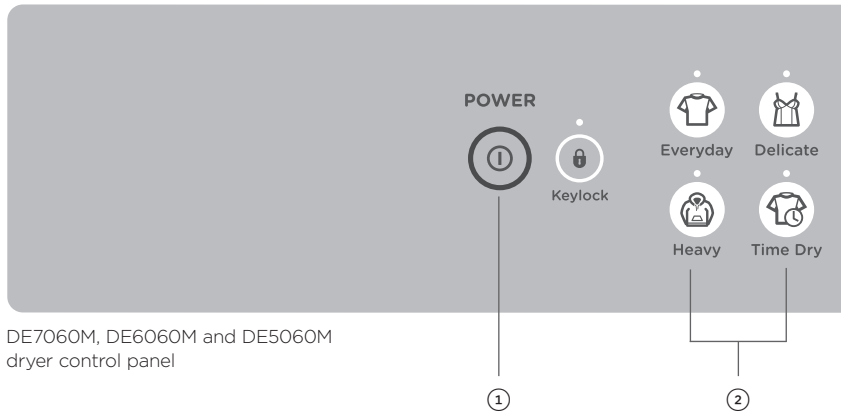

GETTING STARTED QUICKLY

- If you make an invalid selection the dryer will beep to alert you.
- When the cycle finishes, your dryer will beep and then turn off automatically.
- If you wish to change a cycle once drying has started, press the ►|| button then select the new cycle. Press ►|| to restart the dryer with the new cycle. This may affect drying performance.

IMPORTANT!

- **If you wish to stop the dryer before the cycle has finished you MUST remove the clothes IMMEDIATELY and spread them out to cool. DO NOT leave the clothes in the dryer or bunched up in a clothes basket. Take extreme care as the drum and the load items may be extremely hot.**
- **Failure to follow the advice in this guide may result in damage to your garments and your expectations of drying performance may not be met.**

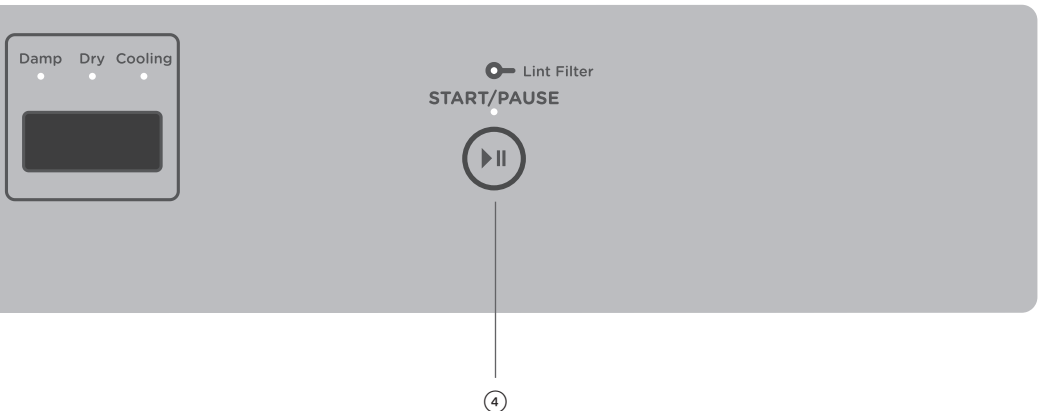
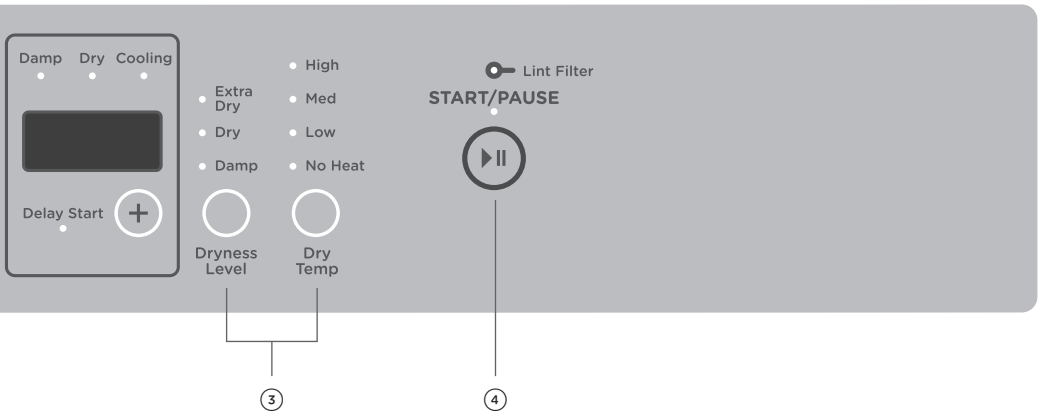

DRYER CONTROLS

Digital display screen

The digital display screen provides feedback on how long the drying cycle has to go. If you have programmed a 'Delay Start' (DE7060M, DE6060M and DE5060M models only), the screen will display the time remaining before the cycle starts, along with any messages to help you with the overall running of your dryer (eg user warnings).



Digital display screen

Time to go

If you have selected one of the Time Dry cycles your dryer displays approximately how many minutes the cycle has remaining. The word *AUTO* is displayed on the screen for automatic cycles.

Please be aware that a number of factors can influence the overall cycle time, eg the fabric type and construction of garment, load size, how wet the load is, etc.



Time to go

Progress lights

The progress lights indicate what stage of the cycle the dryer is currently at ('Damp', 'Dry' or 'Cooling'). All three lights are on at the beginning of the cycle. The light for the current stage of the cycle flashes, and each one goes out when that stage of the cycle is complete.



Progress lights

Keylock

Keylock can be used to lock the buttons on your dryer. This will avoid accidental button presses. For more detail please refer to the 'Drying cycle options' section.



Keylock mode

SORTING AND LOADING

When preparing your load there are some important things to consider:

Sorting

- It is best that you sort your garments before placing them into the dryer. Sort into loads of similar items, and loads that will take similar times to dry. Heavier items (eg towels and flannelette sheets) are best dried separately from lightweight items (eg synthetics, polyester-cotton sheets and shirts). This prevents the possibility of some items becoming over-dried whilst others are still damp. It will also help to extend the life of your clothing and linen.
- Drying your clothes as soon as you remove them from the washer will decrease the chance of wrinkles and of dye transfer from coloured items to white items.
- Garments with hooks or zippers should be fastened where possible and turned inside out.
- Care labels on garments provide valuable information about the fabric type and how the garment should be dried. Always follow the advice on the garment labels. Only dry items in this dryer that have a care label stating tumble drying is suitable.
- Separate coloured items from white/light items where possible, especially when new. Colour run may be an issue, especially if you intend to delay the start of the drying cycle.

SPECIFIC ITEM DRYING REQUIREMENTS	SUGGESTED CYCLE AND OPTIONS	SUGGESTED TEMPERATURE	COMMENTS
Towels	Everyday	High	Towels produce a lot of lint and are best dried on their own.
Sheets, pillowcases, duvet/doona covers	Everyday	High	Ensure duvet/doona cover openings are buttoned/domed before placing in the dryer.
Bulky items - Small blankets and jackets	Delicate	Medium	Only dry one bulky item at a time and place a few knotted towels into the dryer at the same time to ensure the bulky item moves around evenly.
Delicates, fine fabrics and synthetics	Delicate	Medium	You can further reduce the dryness level to damp.
Jeans	Heavy	High	Turn jeans inside out to help maintain their appearance. Dry separately from other items.

SORTING AND LOADING

Before you load

- Check pockets for items that could damage your clothes or get caught in the dryer.
- Close zippers, hooks and eyes and other fastenings (ie fasten the openings of duvet/ doona covers) and remove loose bra wires. These may damage both your dryer and your clothes.
- Check the lint filter is clean.

Loading

Garments need to be loaded correctly to minimise creasing and wrinkling and to ensure the load is dried evenly. Make sure there is plenty of room for the garments to tumble freely while drying.

Hint: load the dryer in terms of the space the garments take up when dry, rather than when they are wet. Do not overload your dryer, as this may damage your dryer and clothes.

To reduce tangling

- Load items individually.
- Ensure duvet/doona covers are fastened before placing in the dryer.

To reduce creasing

- Shake clothes out and load individually to help items dry evenly.
- Launder permanent press garments separately, eg business shirts.
- Allow enough room in the dryer for clothes to tumble freely.
- Hang garments as soon as the drying cycle is complete to reduce the need for ironing.

IMPORTANT!

- **Never put dripping wet clothes in or on top of the dryer as excess water may cause an electrical hazard.**
- **Do not place an item in your dryer unless the care label specifically states it is safe to do so.**
- **Always follow the instructions on the care label.**
- **Do not dry curtains in your dryer. Sunlight makes them brittle and they may disintegrate during drying.**

SORTING AND LOADING

Drying times

- Drying very small loads is inefficient. Try to dry medium to large loads.
- Heavier items (towels and flannelette sheets) will take longer to dry than light items (synthetics and polyester cotton sheets and shirts).
- Drying times can be reduced by spinning the wash load at the highest spin speed suitable for the load type in your washing machine.

Drying bulky items

- It is important that you check the care label of any item carefully, to ensure it is suitable for tumble drying, before placing it into the dryer.
- Check bulky items during the cycle to ensure even drying, pause the dryer and reposition the item if necessary.
- Do not overload the dryer. Ensure there is enough space for the dry item to tumble.

Lint

Some items are lint givers, while others are lint collectors. Always dry lint givers and collectors separately.

LINT GIVERS	LINT COLLECTORS
Towels	Synthetics eg polar fleece
Flannelette sheets	Corduroy
	Polyester cottons

DRYING CYCLES

DE7060M model

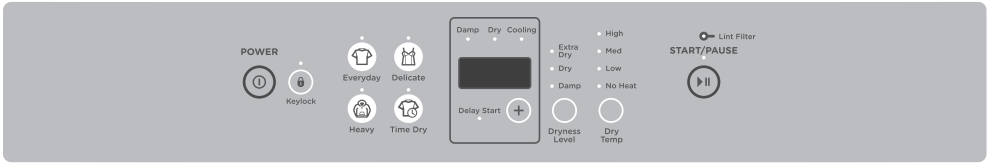

Your dryer has a number of drying cycles to suit your laundry needs. Selecting the most appropriate cycle for each particular load will help to ensure you get the best result.

CYCLE	DESIGNED FOR	DESCRIPTION	MAX. LOAD SIZE (kg)	DEFAULT DRYNESS LEVEL*	DEFAULT DRYING TEMP
Everyday**	Everyday clothing, eg t-shirts, trousers.	High heat cycle for rapid drying of everyday clothing.	7	Dry	High
Heavy	Heavy durable garments, eg work sweatshirts/jerseys, rugby shorts, jeans, tea towels.	Longer, high heat cycle for heavier fabrics and denim.	6	Dry/Extra Dry	High
Delicate	Delicate clothing items, eg synthetics and fine fabrics.	Cooler cycle for carefully drying delicate and heat sensitive fabrics.	4	Dry	Medium
Time Dry	Clothes that you wish to dry for a specific time period.	User selectable 30 - 150 minute drying time.	6	N/A	High

* Dryness level is only an option on automatic sensing cycles. On the 'Time Dry' cycle, dryness will vary depending on the load and its initial moisture content.

** 'Everyday', 'Extra Dry', 'High' dry temp is the recommended cycle for everyday cotton items.

DRYING CYCLES

DE6060M and DE5060M models

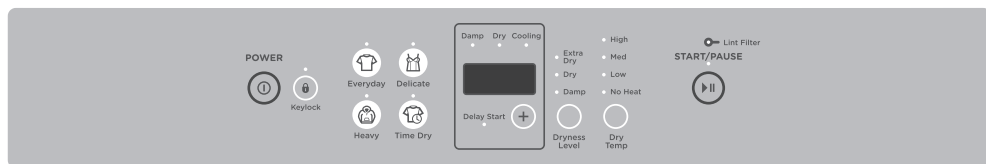

Your dryer has a number of drying cycles to suit your laundry needs. Selecting the most appropriate cycle for each particular load will help to ensure you get the best result.

CYCLE	DESIGNED FOR	DESCRIPTION	MAX. LOAD SIZE (kg)*	DEFAULT DRYNESS LEVEL**	DEFAULT DRYING TEMP
Everyday***	Everyday clothing, eg t-shirts, trousers.	High heat cycle for rapid drying of everyday clothing.	5 or 6	Dry	High
Heavy	Heavy durable garments, eg work sweatshirts/jerseys, rugby shorts, jeans, tea towels.	Longer, high heat cycle for heavier fabrics and denim.	5	Dry/Extra Dry	High
Delicate	Delicate clothing items, eg synthetics and fine fabrics.	Cooler cycle for carefully drying delicate and heat sensitive fabrics.	4	Dry	Medium
Time Dry	Clothes that you wish to dry for a specific time period.	User selectable 30 – 150 minute drying time.	5	N/A	High

* Depends on your model of dryer (5 or 6kg capacity).

** Dryness level is only an option on automatic sensing cycles. On the 'Time Dry' cycle, dryness will vary depending on the load and its initial moisture content.

*** For DE5060M model 'Everyday', 'Dry', 'High' dry temp is the recommended cycle for everyday cotton items. For DE6060M model 'Everyday', 'Dry/Extra Dry', 'High' dry temp is the recommended cycle for everyday cotton items.

DRYING CYCLES

DE4560M model

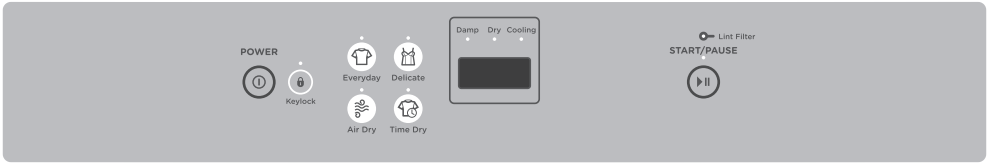

Your dryer has a number of drying cycles to suit your laundry needs. Selecting the most appropriate cycle for each particular load will help to ensure you get the best result.

CYCLE	DESIGNED FOR	DESCRIPTION	MAX. LOAD SIZE (kg)
Everyday*	Everyday clothing, eg t-shirts, trousers.	High heat cycle for rapid drying of everyday clothing.	4.5
Air Dry	Clothes that you wish to dry for a specific time period, without heat.	40 minute timed cycle with no heat.	2
Delicate	Delicate clothing items, eg synthetics and fine fabrics.	Cooler cycle for carefully drying delicate and heat sensitive fabrics.	3
Time Dry	Clothes that you wish to dry for a specific time period.	User selectable 30 - 150 minute drying time.	4

* 'Everyday' is the recommended cycle for everyday cotton items.

DRYING CYCLE OPTIONS

Timed programmes (Time Dry)

The dryer dries for the selected time regardless of the level of moisture in your clothes. It is important to check the clothes throughout the timed programmes to avoid over drying.

To select the length of time for the cycle press 'Delay Start + ' (DE7060M, DE6060M and DE5060M) or 'Time Dry' (DE4560M) to scroll through the time selections available.

Drying cycles

All drying cycles default to the recommended options for that cycle based on the average expected load to be dried using that cycle. You can vary the options for the DE7060M, DE6060M and the DE5060M models only (eg 'Dryness Level', 'Dry Temp') to create your desired cycle. Note: some options are not available on some cycles, for clothes care reasons, or because the option is not appropriate for the cycle.

To change a drying cycle you have selected after a cycle has started, press ►|| and select your new cycle, then press ►|| again to resume drying.

Note: some options may not be available for selection under certain conditions and after particular stages of the drying cycle have passed.

Dryness Level (DE7060M, DE6060M and DE5060M models only)

Your dryer takes the guess work out of choosing drying times by sensing the dryness of the load. When your dryer senses that the clothes have dried to the dryness level you have selected, the dryer will automatically finish the cycle.

The dryer has five dryness levels from 'Damp' through to 'Extra Dry'. Choose the dryness level to suit your load depending on how dry you wish for your clothes to be. If you find the load is not dry enough, select the next dryness level up. The higher the level, the longer the drying time and the drier your clothes will become.

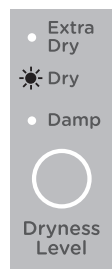

Dryness Level

Airing/Cool down (Cooling)

When the dryer has sensed that the load is dry it will automatically go into an airing or cool down cycle. During 'Cooling' the drum tumbles and cool air is blown through the clothes. This cools the load to reduce creasing if the clothes are left in the dryer.



Cool down mode

DRYING CYCLE OPTIONS

Dry Temp (DE7060M, DE6060M and DE5060M only)

There are four drying temperatures you can choose from:

- **High:** Clothes temperatures reach up to 80°C.
- **Medium:** Clothes temperatures reach up to 70°C.
- **Low:** Clothes temperatures reach up to 45°C.
- **No heat:** Cool air is blown through the dryer for the period selected.

Press the 'Dry Temp' button until the light next to your desired drying temperature is illuminated.





Dry Temp



Indicator lights

The lint filter light will flash when the machine is switched on as a reminder to clear the lint filter before each cycle.



Keylock

This option enables you to deactivate the buttons on the display panel, except for the 'POWER'  and  buttons. This option helps prevent accidental button presses.

To turn Keylock mode ON or OFF, at any time when the dryer is powered on:

- Press and hold the  button for 2 seconds.
Note: when activated, the light above the  button is illuminated.

If Keylock mode is activated and the dryer is powered off:

- To turn your dryer on, press the 'POWER'  button, then press and hold the  button for two seconds to turn Keylock off. Select your drying cycle, any options and then press  to start the cycle.

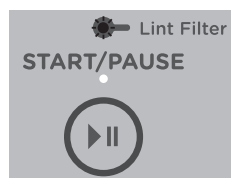

Indicators

DRYING CYCLE OPTIONS

Delay Start (DE7060M, DE6060M and DE5060M only)

The 'Delay Start' option enables you to delay the start of the drying cycle from between 5 minutes and 12 hours. Times you can select are 5 min, 15 min, 30 min, 1 hour, then hourly up to 12 hours. This can be useful to time your drying to finish when you arrive home from work, or to start when power rates are lower.

To programme a 'Delay Start', simply press the **+** button to cycle through the delay start times available. To decrease or turn off 'Delay Start' continue to cycle through the time options. Press **▶||** to confirm your selection and start the countdown. Once the 'Delay Start' has been started, the time will count down on the digital display in one minute increments, the 'Delay Start' light will flash and the **▶||** light will stop flashing and remain lit.

The 'Delay Start' option is not available on the 'Time Dry' cycle.

IMPORTANT!

We suggest that you avoid using 'Delay Start' for damp, non-colourfast items as this may cause dye run to occur.

Customising dryer cycles (DE7060M, DE6060M and DE5060M models only)

After using your dryer a few times you may discover there are some drying options you prefer for some cycles.

You can programme your dryer to remember the drying options you prefer for each drying cycle. For instance, you may want to set the 'Everyday' cycle to a lower drying temperature.

To customise a cycle:

- ① Press 'POWER' **ⓘ** to turn the dryer on.
- ② Select the cycle you wish to customise.
- ③ Press and hold any of the drying options buttons for 3 seconds. The lights will flash on and off and the display will show **SEt** to indicate that the dryer is in cycle adjustment mode.
- ④ Select the drying options you prefer by pressing the relevant option button.
- ⑤ Press and hold **Ⓛ** for 3 seconds to save the selected settings. The dryer will then beep to indicate your customised cycle has been saved.

Factory reset

You can reset your dryer to the default settings it left the factory with:

- ① Press and hold the 'Keylock' and 'Delicate' buttons together for three seconds.
- ③ Your dryer will now be reset to the default settings.

CLEANING YOUR DRYER

When you have finished using your dryer

- Unplug the dryer from the power socket.
- Wipe around the door to remove any remaining condensation and/or foreign matter.
- Clear the lint filter.

Cleaning your dryer

Before you start cleaning your dryer, ensure that it is disconnected from the power source (ie unplug the dryer from the power socket).

Cleaning the control panel and outer surfaces of the dryer

Use a soft damp cloth to wipe all surfaces, then wipe dry. Avoid using chemical or scouring cleaners, as these will damage the paint and plastic surfaces of your dryer.

Cleaning the inside of your dryer

It is important that you occasionally clean the inside of your dryer. If the drum has any residual dirt or lint stuck to it, remove this and wipe it clean with a damp cloth. Do not leave any metal objects in the drum, as these may cause rust.

Cleaning the lint filter

- Lint is generally formed during wearing and washing. Fibres (ie lint) released from the clothes during the drying cycle are collected in the lint filter.
- It is important to clean the lint filter after every load, as the lint produced in the drying process can become a fire hazard if it is allowed to accumulate in or around your dryer.
- The lint filter is located in the door opening (at the bottom).
- There is a warning light that will flash at the beginning of every cycle to remind you to clean the filter. Lint becomes a fire hazard if left to build up, and will reduce the efficiency of your dryer.

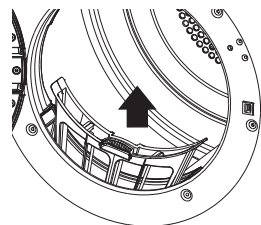

Lint filter

To clean the lint filter:

- ① Open the dryer door.
- ② Remove the lint filter by pulling it up and out of the filter slot. Open it out and wipe the surface clean with your hand.
- ③ Close the lint filter and place it back in the opening. Ensure the filter is fitted correctly back in place before operating the dryer.

IMPORTANT!

If the lint filter becomes damaged, contact your Fisher & Paykel trained and supported service technician to arrange for a replacement filter. Do not operate your dryer with a damaged lint filter or without the filter in place, as this will cause damage to your dryer.

BEFORE YOU CALL FOR SERVICE

Your dryer is capable of diagnosing a number of its own problems. It will sound a continuous series of beeps and display a code when it has a problem that you can correct yourself. All control panel lights will turn off and a code will be displayed to inform you what the problem is. To stop the beeps sounding, press any button on the control panel. Do not try to continue your drying cycle once you stop the beeps. You must address the problem the dryer is alerting you to.

User warnings

Check this chart before you call for service.

PROBLEM	DISPLAYED AS	WHAT TO DO
Keylock is activated.	KEY LOC	Touch and hold the 'Keylock' button for 2 seconds to deactivate the Keylock.
The door is not closed	door OPEN	Close the door fully and press ► . Try opening and closing the door again. Reposition the load, make sure the load is correctly in the drum and that protruding items are not stopping the door from closing.
Dryer has been paused	PAUS	Press the ► to resume the cycle.

Once you have addressed the issue the user warning was alerting you to, try using your dryer as per usual.

If the symptom persists, call your Fisher & Paykel trained and supported service technician.

Fault codes





When a continuous series of beeps is sounded, all the lights turn off on the control panel and a number appears on the display, a fault has occurred. The dryer will automatically enter this mode if a fault occurs. The fault code will be displayed as ERR followed by a number on the digital display. To stop the beeps, press any button then perform the following steps:

- ① Turn your dryer off at the power point.
- ② Wait one minute and turn it back on.
- ③ Check your dryer is installed correctly (refer to the 'Installation instructions' section).
- ④ Remove your dryer load and retry.
- ⑤ Perform a 'Time Dry' cycle, eg 'Time Dry' for 30 minutes.
- ⑥ If the fault re-occurs repeat steps ① and ②.
- ⑦ If the dryer still will not work you will be required to call a Fisher & Paykel trained and supported service technician to arrange service (refer to the 'Customer Care' section). Record the fault code number displayed and the serial number of your dryer (located on the rear of the dryer, or on the inside of the door below the glass, when the door is open) before calling. The fault code will indicate to the service technician what the problem could potentially be.

If a fault code is being displayed, you can still turn your dryer off by pressing 'POWER' ①.

TROUBLESHOOTING

The following is a list of problems you may encounter when using this appliance and some suggestions that may help to correct the problem. If you still have problems, please contact your Fisher & Paykel trained and supported service technician.

PROBLEM	POSSIBLE CAUSES	WHAT TO DO
Pressing 'POWER'  does not turn on the dryer.	Fault with household power supply.	Try plugging in and turning on another electrical appliance.
Pressing  does not start the drying cycle.	Dryer could be displaying a user warning or fault code. 'Delay Start' function is set.	Refer to page 29. Refer to page 27 for more information.
Dryer stops working mid-cycle.	Power failure.	Press 'POWER'  and restart the desired cycle.
	Dryer has been paused.	Press the  button to restart the cycle.
	Dryer door is open.	Ensure the door is firmly shut. Reposition the load, make sure the load is correctly in the drum and that protruding items are not stopping the door from closing.
Dryer is taking too long/ results were not satisfactory.	Drying cycle selected not appropriate for the load.	Select an appropriate cycle for the load. Refer to pages 19, 22, 23 and 24.
	Dryness level selected not appropriate for the load.	Select a higher dryness level. Refer to page 25.
	Selected drying temp, not appropriate for the load.	Select a higher drying temp. Refer to page 26.
	Dryer overloaded for the cycle.	Some cycles have a lower maximum load size. Refer to pages 22 - 24. Try dividing the load in half and dry half at a time.
	Lint filter is blocked.	Clean the lint filter.
	Load overly wet at the start of cycle.	Remove more water from the load before placing it in the dryer, eg select a faster spin on your washer, a spin speed appropriate for your load.
Clothes getting too hot or damaged.	Cycle selected not appropriate for the load.	Ensure the cycle selected is appropriate for items in the load. Refer to pages 19, 22, 23 and 24.
	Items removed from dryer before the end of cycle cool down had finished.	Removing items before cool down may damage clothing if it is not spread out and exposed to cooler air once removed from the dryer.

TROUBLESHOOTING

PROBLEM	POSSIBLE CAUSES	WHAT TO DO
<p>Dryer is beeping, displaying unfamiliar light patterns and/ or a message on the digital display.</p>	<p>Dryer has a fault.</p>	<p>Refer to page 29.</p>
<p>Noises.</p>	<p>Dryer is overloaded. Dryer has a fault.</p>	<p>Remove some items from the dryer. Continuous beeping or a musical series of beeps with a message displayed on digital display. Refer to page 29.</p>
<p>Vibration.</p>	<p>Dryer is not installed on a stable surface. Dryer is overloaded.</p>	<p>Ensure the dryer is installed on a flat, stable surface. Refer page 7. Remove some items from the dryer.</p>
<p>Creasing.</p>	<p>Dryer is overloaded. 'Dry Temp' and/or 'Dryness Level' selected too hot/ too long for load type (DE7060M, DE6060M and DE5060M only).</p>	<p>Remove some items from the dryer. Try selecting a lower 'Dry Temp' and 'Dryness Level'.</p>
<p>Dye transfer.</p>	<p>White/light and coloured items not separated before drying. Wet items left sitting in the dryer for long periods of time before drying.</p>	<p>Remember to separate white/light and coloured items before placing them in the dryer. Do not leave wet items sitting in the dryer for long periods of time before drying, if they are prone to colour run. If you do intend to leave them for long periods before drying, then separate the load and put those items that may cause colour run aside.</p>

TROUBLESHOOTING

PROBLEM	POSSIBLE CAUSES	WHAT TO DO
Linting.	Lint filter not cleaned or replaced.	Ensure the lint filter is cleaned after every cycle and replaced correctly. Refer to page 28.
	Loads not sorted correctly.	Dry lint gives separately from lint receivers. Dry similar colours together eg light coloured items with light coloured items, dark items with dark items. Refer to pages 19 and 21.
	Clothes over dried.	Over drying clothes in the dryer can cause them to attract lint. Use an auto sensing cycle or ensure you check your load if using the time dry cycles, to avoid over drying. Refer pages 22 – 24.
	New items have been dried in the dryer recently. New towels or flannelette sheets can leave lint in the dryer, which may be picked up by subsequent loads.	Clean the lint filter and use 'Air Dry' or 'Time Dry' 'No Heat' cycle to clear any remaining lint from the dryer.
	Fabric damage.	Catching on a metal part on items in the load.
Items not separated or dried on an appropriate cycle for the fabric type.		Dry similar items together. Ensure an appropriate cycle is selected. Refer to pages 19, 22, 23 and 24.
'Dry Temp' or 'Dryness Level' selected not appropriate for the fabric type (DE7060M, DE6060M and DE5060M only).		Ensure the 'Dry Temp' and 'Dryness Level' selected is appropriate for the fabric type. Refer to the items care label. Refer to pages 22 – 24.
Used a 'Time Dry' cycle and did not monitor the dryness of clothes during the cycle.		Ensure that clothes are checked for dryness during the cycle when using the timed programmes to avoid over drying. Refer to pages 22 – 24.
Instructions on care label not followed.		Follow the instructions on the care label of the items.

TROUBLESHOOTING

PROBLEM	POSSIBLE CAUSES	WHAT TO DO
Tangling.	Loads not separated during loading.	Try separating out larger items from smaller items.
	Items loaded into the dryer incorrectly.	Load items individually into the dryer. Do not place folded items in the dryer.
	Load size too large.	Try drying smaller load sizes. Some cycles have a lower maximum load size. Refer to pages 22 - 24.
	Sheets and duvet covers due to their size, are prone to tangling.	Dry sheets and duvet/doona covers separately from other laundry. Ensure duvet/doona covers are buttoned or fastened closed before drying. Try adding a knotted towel to sheets loads if you are experiencing a lot of tangling. Sheets and duvet/doona covers due to their size, are prone to tangling.

MANUFACTURER'S WARRANTY

You automatically receive a 2 year Manufacturer's Warranty with the purchase of this vented clothes dryer covering parts and labour for servicing within the country of purchase.

Fisher & Paykel undertakes to:

Repair or, at its option, replace without cost to the owner either for material or labour any part of the product, the serial number of which appears on the product, which is found to be defective within TWO YEARS of the date of purchase.

Note: this Manufacturer's Warranty is an extra benefit and does not affect your legal rights.

This Manufacturer's Warranty DOES NOT cover

- (A) Service calls which are not related to any defect in the product. The cost of a service call will be charged if the problem is not found to be a product fault. For example:
 - ① Correcting the installation of the product.
 - ② Instructing you how to use the product.
 - ③ Replacing house fuses or correcting house wiring or plumbing.
 - ④ Correcting fault(s) caused by the user.
 - ⑤ Noise or vibration that is considered normal, eg drain/fan sounds, machine noises or user warning beeps.
 - ⑥ Correcting damage caused by pests, eg rats, cockroaches, etc.
 - ⑦ Poor drying performance due to incorrect installation and maintenance eg blocked lint filter.
 - ⑧ Poor drying performance due to incorrect loading, eg overloading or underloading.
 - ⑨ Damage from articles in the drum, eg bra wires, pens, crayons, dye transfer or flammable material.
- (B) Defects caused by factors other than:
 - ① Normal domestic use; or
 - ② Use in accordance with the product's user guide.
- (C) Defects to the product caused by accident, neglect, misuse or 'act of God'.
- (D) The cost of repairs carried out other than by a Fisher & Paykel trained and supported service technician or the cost of correcting such repairs.
- (E) Normal recommended maintenance as set out in the product's user guide.
- (F) Repairs when the appliance has been dismantled, repaired or serviced by other than a Fisher & Paykel trained and supported service technician or the selling dealer.
- (G) Pick-up and delivery.
- (H) Transportation or travelling costs involved in the repair when the product is installed outside the Fisher & Paykel trained and supported service technician's normal service area.

Nothing in this Manufacturer's Warranty is intended to, or does limit, any rights you may have under law to recover the costs of inspecting or returning the goods to us.

This product has been designed for use in a normal domestic (residential) environment. This product is not designed for any commercial use (whatsoever). Any commercial use by a customer will affect this product's Manufacturer's Warranty.

MANUFACTURER'S WARRANTY

Service under this Manufacturer's Warranty must be provided by a Fisher & Paykel trained and supported service technician (refer to the 'Customer Care' section at the back of this book). Such service shall be provided during normal business hours. This Manufacturer's Warranty certificate should be shown when making any claim.

For Australian Customers

This Manufacturer's Warranty is an extra benefit and does not affect your legal rights. Our goods come with guarantees that cannot be excluded under the Australian Consumer Law. You are entitled to a replacement or refund for a major failure and compensation for any other reasonably foreseeable loss or damage. You are also entitled to have the goods repaired or replaced if the goods fail to be of acceptable quality and the failure does not amount to a major failure.

Please keep this user guide in a safe place.

CUSTOMER CARE

Before you call for service or assistance...

Check the things you can do yourself. Refer to your user guide and check:

- ① Your product is correctly installed.
- ② You are familiar with its normal operation.
- ③ You have read the 'Before you call for service', 'Fault codes' and 'Troubleshooting' sections at the back of the book.

If after checking these points you still need assistance or parts, please refer to your nearest Fisher & Paykel trained and supported service technician, Customer Care, or contact us through our website fisherpaykel.com.

In New Zealand if you need assistance...*

Call the Fisher & Paykel Customer Care Centre and talk to one of our Customer Care Consultants.

Toll Free: 0800 FP CARE or 0800 372 273

Fax: (09) 273 0656

Website: fisherpaykel.com

Postal address: Fisher & Paykel Appliances Ltd, PO Box 58550, Botany, Auckland 2163

If you need service...*

Fisher & Paykel has a network of Fisher & Paykel trained and supported service technicians that can carry out any service necessary on your appliance. Our Customer Care Centre can recommend a Fisher & Paykel trained and supported service technician in your area.

In Australia if you need assistance...*

Call the Fisher & Paykel Customer Care Centre and talk to one of our Customer Care Consultants.

Toll Free: 1300 650 590

Fax: (07) 3826 9298

Website: fisherpaykel.com

Postal address: Fisher & Paykel Appliances Australia Pty Ltd, PO Box 798, Cleveland QLD 4163

If you need service...*

Fisher & Paykel has a network of Fisher & Paykel trained and supported service technicians that can carry out any service necessary on your appliance. Our Customer Care Centre can recommend a Fisher & Paykel trained and supported service technician in your area.

In Singapore if you need assistance...*

Call the Fisher & Paykel Customer Care Centre and talk to one of our Customer Care Consultants.

Phone: 6741 0777

Fax: 6547 0123

Website: fisherpaykel.com

Postal address: 150 Ubi Avenue 4, Sunlight Building #03-01A, Singapore 408825

CUSTOMER CARE

*If you call, write or contact us via our website please provide: your name and address, model number, serial number, date of purchase and a complete description of the problem. This information is needed in order to better respond to your request for assistance.

Product details can be found on the rear of the dryer, and/or on the inside of the door below the glass (when the door is open).

Registration

Register your product with us so we can provide you with the best service possible. To register your product visit our website: **fisherpaykel.com**

Complete and keep for safe reference:

Model _____

Serial No. _____

Purchase Date _____

Purchaser _____

Dealer _____

Suburb _____

Town _____

Country _____

FISHERPAYKEL.COM

© Fisher & Paykel Appliances 2017. All rights reserved.

The product specifications in this booklet apply to the specific products and models described at the date of issue. Under our policy of continuous product improvement, these specifications may change at any time. You should therefore check with your Dealer to ensure this booklet correctly describes the product currently available.

NZ AU SG ROW

428118F 11.17