

# C3-SSD28 INSTALL GUIDE

## DIMENSIONAL RENDERINGS

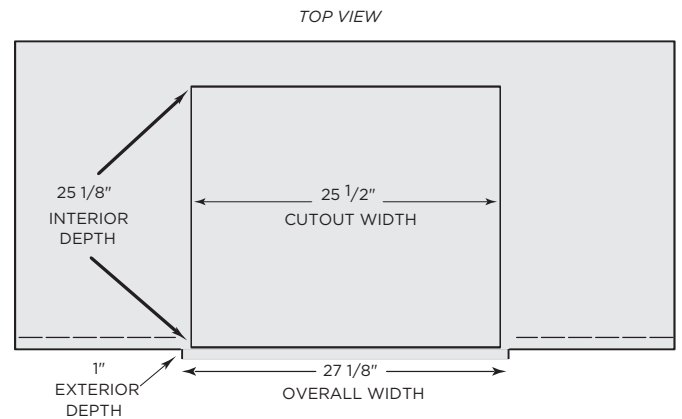
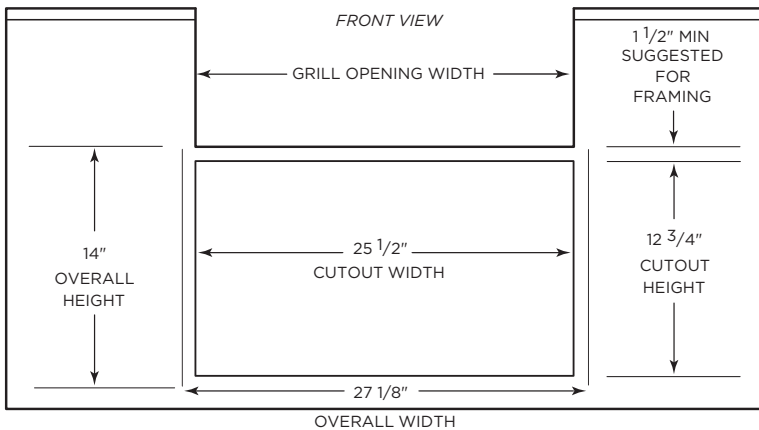
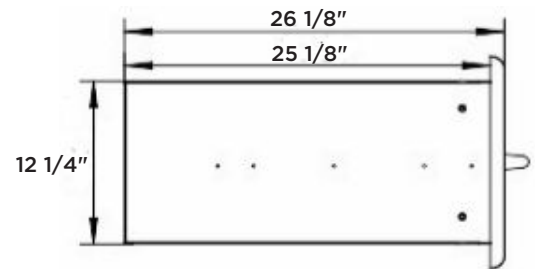
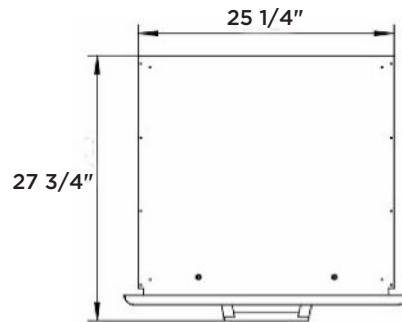
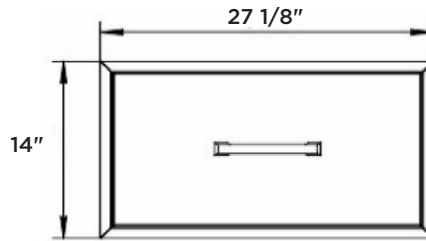
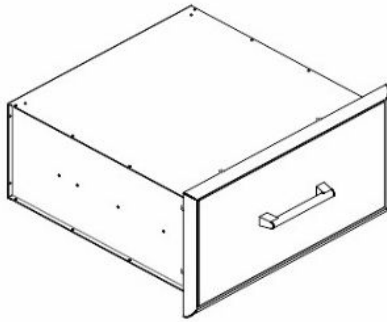

Overall Product Dimensions			
Model No.	Height	Width	Depth
C3SSD28	14"	27 1/8"	26 1/8"

Cutout Dimensions for Island			
Model No.	Height	Width	Depth
C3SSD28	12 3/4"	25 1/2"	25 3/8"

### Install Notes:

- ✓ The drawer has a gasket to keep moisture out and is capable of holding 80 lbs
- ✓ 2 anchor points are located on each side of the doors interior frame (top, bottom, left and right)
- ✓ Due to wide variance of possible building materials, anchors are not included
- ✓ When inserting your anchors be sure to use a framing square to ensure the door is not pulled out of square
- ✓ Additional framing and/or support underneath the rear (hanging portion) of the cabinet is recommended
- ✓ These specs are accurate but we always suggest having the product physically on site to ensure full understanding of how this product will coordinate with your build