

User Manual

Portable CD player with peakers

BBS-01

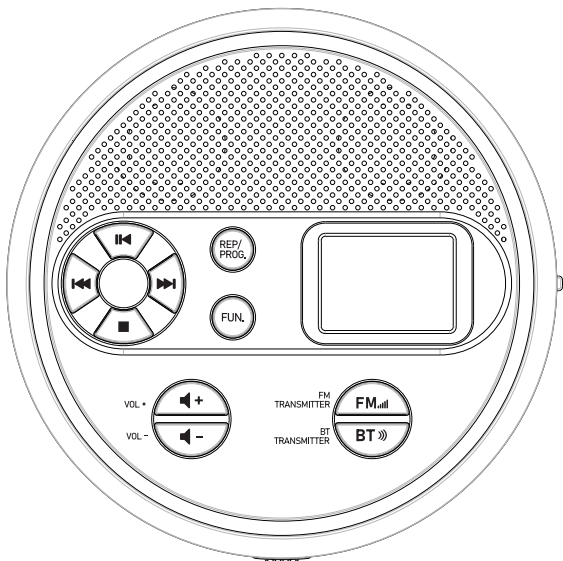

Thank you for choosing our portable CD player. This high-quality unit is carefully engineered to deliver exceptional sound. To ensure optimal performance and longevity, please read this manual thoroughly before use and follow all operating and maintenance instructions.

USER MANUAL-EN ----- P1-P10

BENUTZERHANDBUCH-DE ----- P11-P19

MANUALE D'USO-IT ----- P20-P28

MANUEL D'UTILISATION-FR ----- P29-P39

CONTENTS

- VERY IMPORTANT TIPS
- BUTTON DESCRIPTIONS
- FUNCTION DESCRIPTIONS
- CD DISC/USB DISK MODE
- BLUETOOTH MODE
- FM TRANSMISSION FUNCTION
- BLUETOOTH TRANSMISSION FUNCTION
- LINE OUT FUNCTION
- SPECIFICATIONS
- SAFETY INSTRUCTIONS
- WARRANTY
- PACKING LIST

VERY IMPORTANT TIPS

- ▲ This CD player is a CLASS 1 LASER product.



- ▲ When the CD cover is opened or carelessly closed, an invisible laser will be generated.



- ▲ Please do not touch the bald head at will, otherwise it will affect the playback performance.

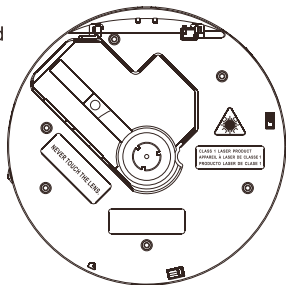

BUTTON DESCRIPTIONS

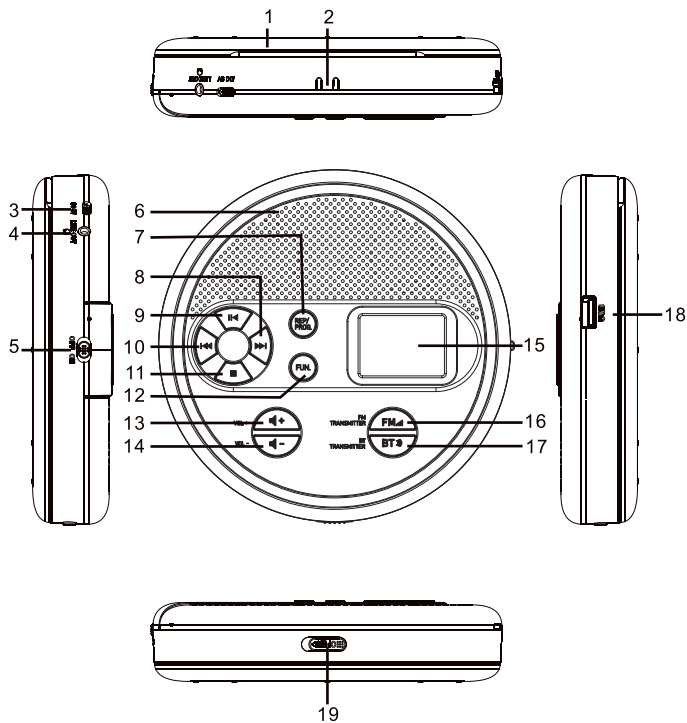

Item	Name	Description
1.	CD door	Make sure the CD door is closed when in use
2.	Carry strap hole	Lanyard location.
3.	DC 5V socket	DC 5V power supply/charging.
4.	Earphone jack	3.5mm Earphone output jack.
5.	ON-OFF	Power on/off switch.
6.	Internal speaker	Built-in stereo dual speakers.
7.	Repeat/Program button	1. In the process of playing CD/USB, press this button to Single/All/Random/Play first 10s of file playback mode. 2. When CD/USB is in STOP state, short press this button on the machine to entry the programming interface. You can program tracks in CD or USB mode
8.	Next button	Short press to skip to the next track. Long press to fast forward.
9.	Play/Pause button	Press this button to start or pause the play(CD/USB/Bluetooth mode)
10.	Previous button	Short press to skip to the previous track, Long press to fast rewind.
11.	STOP/SLEEP button	Short press for stop playback, Long press for sleep function. (OFF-90min)
12.	FUN. button	CD-USB-Bluetooth function selector.
13.	Volume increase button	Press to increase volume.(The volume range is 00-15)
14.	Volume decrease button	Press to decrease volume.(The volume range is 00-15)
15.	LCD display screen	Function display area.
16.	FM TRANSMITTER button	1. Press first time to enter FM transmit setup status. 2. Press second time to enter FM transmit status. 3. Press again to cancel this function
17.	BT TRANSMITTER button	Press first time to enter to Bluetooth transmit status, press again to cancel it.
18.	USB disk port	Insert USB disk for song playback.
19.	CD door open switch	Push to open CD door.

FUNCTION DESCRIPTIONS

POWER SUPPLY

A rechargeable polymer battery is built into the CD player. When found the battery icon no power in LCD display right top corner, it needs to be connected to the external Type-C USB 5V/2A for charging. You can see the battery charging status on the screen and the cable needs to be unplugged after a full charge. It takes about 3-4 hours to fully charge the battery.

HOW TO CONNECT HEADSET

You can use earphones to listen to the music played by the machine. Just plug the 3.5mm headphones into the earphone port, and the speaker will be automatically disconnected at this time.

SLEEP FUNCTION

1. In the power on state, long press the SLEEP button to enter sleep mode, LCD Display screen shows "90" or "OFF" and "SLEEP".



2. Short press Previous/Next button to select automatic shutdown time between OFF-10-20-30-40-50-60-70-80-90min. Press the SLEEP button again to confirm the setting.



3. When SLEEP mode is in use, the LCD screen displays as shown below:



CD DISC/USB DISK MODE

1. After power on, press the Function Selector button (FUN.) to select CD or USB mode. LCD shown as



2. Under CD Mode:

- a. Push the OPEN button on the right to open the CD compartment door, and place the disc printing surface upward on the spindle of the CD movement.
- b. Then close the CD compartment door completely, otherwise the player will fail to read the disc. And the disc total tracks will show in LCD screen.
- c. After a few seconds, the first track will automatically play while the LCD displays the format of the "CD", "MP3", etc.

3. Under USB mode:

- a. Insert the USB flash disk with songs stored on it into the USB port on the unit to play music.
- b. After a few seconds, the first track will automatically play while the LCD displays the format of the "MP3", etc.

4. Press the Volume increase button (VOL+) once increases the volume by one level, and press the Volume decrease button (VOL-) once decreases the volume by one level. The volume range is 00-15.

5. Press the Play / Pause button (▶||) once to temporarily stop playing, and press this button again to resume playing.

6. If you need to stop playing halfway, press the STOP button (■ /SLEEP) to stop playing.

7. During playback, short press the Previous/Next button (◀||▶) to jump to the previous/next song; long press the Previous/Next button (◀◀||▶▶) to fast rewind or fast forward.

8. Repeat function:



- a. In the process of playing CD/USB, short press the Repeat/Program button (REP./PROG.) once, the current song you listen to will enter into single cycle, and flashing displayed on the LCD as shown in figure a.
- b. Short press the Repeat/Program button (REP./PROG.) twice, if your USB flash drive contains a file directory, it will repeat to play the current folder for you. Displayed on the LCD shown in figure b.

EN

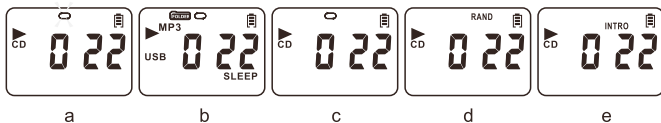
- c. Short press the Repeat/Program button for the third time, the whole disc will be played repeatedly, and displayed on the LCD as shown in figure c.
- d. Short press the Repeat/Program button for the fourth time, the whole disc will be played randomly. Displayed on the LCD as shown in figure d.
- e. Short press the Repeat/Program button for the fifth time, the whole disc will be played in intro, which will play first 10s of each song. The display on the LCD as shown in figure e.
- f. Press the Repeat/Program button for the sixth time to resume to normal playback.



9. Programming Function (When CD/USB is in STOP state)

- a. Press the STOP button () to stop to play the CD discs/USB.
- b. Then short press the Repeat/Program button (REP./PROG.) on the machine to entry the programming interface.
- c. Press Previous/Next button () to select the song you want to program, then press Repeat/Program button (REP./PROG.) to confirm after programming.
- d. Press the Play/Pause button () to play in the sequence of the programmed songs.

BLUETOOTH RECEIVING

1. Short press the Function Selector button(FUN.) to switch to Bluetooth Mode, (LCD shown as



2. Turn on the mobile phone or other Bluetooth device. When it searches for the local Bluetooth device, the Bluetooth name " BBS-01 " will be displayed. After successful pairing, you will hear a prompt tone.

3. The "bLUE" character on the LCD flashes slowly before connecting to the phone, and the "bLUE" is always on after successful pairing and connection.

4. Press the STOP button to disconnect.

BLUETOOTH TRANSMITTING FUNCTION

To Pair a Bluetooth Device (like Bluetooth speaker/Bluetooth earphone/Bluetooth headphone) :

1. Turn on your Bluetooth headphone and set up pairing

2. In CD/USB Mode, press the "BT TRANSMITTER" Button () - watch the icon () blink! Icon () stops blinking when paired!

3. To unpair, press the "BT TRANSMITTER" Button () again.

Pairing Pro Tip:

① To Ensure a Successful Connection:

On the CD Player: Power off any previously connected Bluetooth devices. (This prevents the "BT-TX Connected" error with no sound.)

On Your Bluetooth Headphones: Disconnect your headphones from any other devices (like your phone or tablet). (This allows your headphones to be discovered by the CD player.)

②. Enable Pairing Mode: Set your Bluetooth headphones to their pairing or discoverable mode. (Refer to your Bluetooth headphone's manual for instructions).

③. Select Transmit Mode: Press "BT TRANSMITTER" button() on the CD player to search and connect.

FM TRANSMISSION FUNCTION

1. When playing CD or USB disk, press FM TRANSMITTER button(**FM**)) , LCD will display "FM+FM Frequency (87.5-108MHz) flashing.



2. Then press Next+ or Previous- button (**⏮/⏭**) to set a FM frequency, and press FM TRANSMITTER button(**FM**)) again to confirm to the FM transmitting setting.

3. Use a FM receiver (radio or car radio) and turn it to the same frequency you set on the machine. After successfully paired, the CD player sound will play via the FM receiver.

4. During FM transmission working status, press FM TRANSMITTER button(**FM**)) to cancel FM transmit function .

LINE OUT FUNCTION

When playing CD or USB disk, plug one end of the AUX cable into the LINE OUT port on the unit, and the other end into the speakers, car speakers or other devices for external playback.

SPECIFICATIONS

Model	BBS-01
Supported disc formats	CD/MP3/CD-R/CD-RW
Supported USB formats	MP3/WAV/FLAC
Bluetooth version	5.3
Bluetooth transmission and Reception range	Within 8-10 meters is optimum
FM transmission range	Within 3 meters is optimum
Lithium-ion battery	Lithium-ion polymer 3.7V/ 1500mAh
Power source	DC 5V/2A Type-C charging
Charging voltage	DC5V/2A
Charging time	4.5h
Endurance time	CD:4h USB:7h BT: 9h
CD playback sound	31.5Hz-16kHz \pm 3dB
Speakers output power	1.2W+ 1.2W
Size	146x146x33.5 mm/5.75*5.75*1.32in
Weight	300g/0.68lb

SAFETY INSTRUCTIONS

※Use Environment

1. Do not expose the machine to rain or damp places, and place and use the machine away from bathtubs, washing boxes, swimming pools, etc

2. Do not put any source of danger on the device (for example, objects filled with liquid, lighted candles).
3. Do not use the machine near heat sources, including radiator pipes, heaters or other appliances that generate heat.
4. Put the machine on a flat surface to use.
5. Be careful not to let solids or liquids enter the body from the product.
6. The machine should not be exposed to water droplets or splashes, and objects filled with liquids such as vases should not be placed on the equipment.

※Maintenance

Please place the machine in a well-ventilated place, not in the sun or other places that generate high temperature and humidity. During maintenance, please use a soft cloth moistened with a thinner detergent to wipe the body. Do not use strong solvents such as alcohol, stupid or thinner.

WARRANTY

This CD player has full 12-month warranty against manufacturing defects. The warranty period begins from the date of purchase.

PACKING LIST

CD Player	x1
Type-C Cable	x1
User Manual	x1
Earphones	x1
Storage Bag	x1
AUX Cable	x1

  
Made in China

FCC Statement

This device complies with part 15 of the FCC rules.

Operation is subject to the following two conditions:

- (1) This device may not cause harmful interference.
- (2) This device must accept any interference received, including interference that may cause undesired operation.

Changes or modifications not expressly approved by the party responsible for compliance could void the user's authority to operate the equipment.

NOTE This equipment has been tested and found to comply with the limits for a Class B digital device, pursuant to part 15 of the FCC Rules.

These limits are designed to provide reasonable protection against harmful interference in a residential installation.

This equipment generates, uses and can radiate radio frequency energy and, if not installed and used in accordance with the instructions, may cause harmful interference to radio communications.

However, there is no guarantee that interference will not occur in a particular installation.

If this equipment does cause harmful interference to radio or television reception (which can be determined by turning the equipment off and on), the user is encouraged to try to correct the interference by one or more of the following measures:

Reorient or relocate the receiving antenna.

Increase the separation between the equipment and receiver.

Connect the equipment into an outlet on a circuit different from that to which the receiver is connected. - Consult the dealer or an experienced radio/TV technician for help.