



*Thinking of you*  
**Electrolux**



EWF12822

WASHING MACHINE

USER MANUAL



## CONTENTS

1	SAFETY INFORMATION .....	3
2	PRODUCT DESCRIPTION .....	5
3	CONTROL PANEL .....	6
4	BEFORE FIRST USE .....	12
5	DAILY USE .....	12
6	WASHING HINTS .....	18
7	INTERNATIONAL WASH CODE SYMBOLS .....	21
8	CARE AND CLEANING .....	22
9	TROUBLESHOOTING .....	28
10	TECHNICAL DATA .....	31
11	INSTALLATION.....	32
12	ENVIRONMENT CONCERNS .....	37

## WE'RE THINKING OF YOU

Thank you for purchasing an Electrolux appliance. You've chosen a product that brings with it decades of professional experience and innovation. Ingenious and stylish, it has been designed with you in mind. So whenever you use it, you can be safe in the knowledge that you'll get great results every time. Welcome to Electrolux.

### Visit our website to:



Get usage advice, brochures, trouble shooter, service information:  
**[www.electrolux.com](http://www.electrolux.com)**



Register your product for better service:  
**[www.electrolux.com/productregistration](http://www.electrolux.com/productregistration)**



Buy Accessories, Consumables and Original spare parts for your appliance:  
**[www.electrolux.com/shop](http://www.electrolux.com/shop)**

## CUSTOMER CARE AND SERVICE

We recommend the use of original spare parts.

When contacting Service, ensure that you have the following data available.

The information can be found on the rating plate. Model, PNC, Serial Number.

 Warning / Caution-Safety information.

 General information and tips.

 Environmental information.

Subject to change without notice.

# 1. SAFETY INFORMATION

## Conditions of use

This appliance is intended to be used in household and similar applications such as:

- Farm houses
- By clients in serviced apartments, holiday apartments and residential type environments.

In the interest of your safety and to ensure the correct use, before installing and first using the appliance, read this user manual carefully, including its hints and warnings.

To avoid unnecessary mistakes and accidents, it is important to ensure that all people using the appliance are thoroughly familiar with its operation and safety features.

Save these instructions and make sure that they remain with the appliance if it is moved or sold, so that everyone using it through its life will be properly informed on appliance use and safety.

### 1.1 GENERAL SAFETY

- It is dangerous to alter the specifications or attempt to modify this product in anyway.
- During high temperature wash program the door glass may get hot. Do not touch it!
- Make sure that small pets do not climb into the drum. To avoid this, please check into the drum before using the appliance.
- Any objects such as coins, safety pins, nails, screws, stones or any other hard, sharp material can cause extensive damage and must not be placed into the machine.

- Wash small items such as socks, laces, washable belts etc in a washing bag or pillow case as it is possible for such items to slip down between the tub and the inner drum.
- Only use the advised quantities of fabric softener and detergent. Damage to the fabric or appliance can occur if you overfill. Refer to the manufacturer's recommendations of quantities.
- This appliance is not intended for use by persons (including children) with reduced physical, sensory or mental capabilities, or lack of experience and knowledge, unless they have been given supervision or instruction concerning use of the appliance by a person responsible for their safety.
- Do not use your washing machine to wash articles with whalebones, material without hems or torn material.
- Always unplug the appliance and turn off the water supply after use, clean and maintenance.
- Under no circumstances should you attempt to repair the machine yourself. Repairs carried out by inexperienced persons may cause injury or serious malfunctioning. Contact your local Service Centre. Always insist on genuine spare parts.

### 1.2 INSTALLATION

- This appliance is heavy. Care should be taken when moving it.
- When unpacking the appliance, check that it is not damaged. If in doubt, do not use it and contact the Service Centre.
- All packing and transit bolts must be removed before use. Serious damage can occur to the product and to property if this is not adhered to. See relevant section in the user manual.

- After having installed the appliance, check that it is not standing on the inlet and drain hose and the worktop is not pressing the electrical supply cable.
- If the machine is situated on a carpeted floor, please adjust the feet in order to allow air to circulate freely.
- Always be sure, that there is no water leakage from hoses and their connections after the installation.
- Any plumbing work required to install this appliance should be carried out by a qualified plumber.
- Any electrical work required to install this appliance should be carried out by a qualified electrician.

### 1.3 USE

- This appliance is designed for domestic use. It must not be used for purposes other than those for which it was designed.
- Only wash fabrics which are designed to be machine washed. Follow the instructions on each garment label.
- Do not overload the appliance. See the relevant section in the user manual.
- Before washing, ensure that all pockets are empty and buttons and zips are fastened. Avoid washing frayed or torn articles and treat stains such as paint, ink, rust, and grass before washing. Underwired bras must NOT be machine washed.
- Garments which have been in contact with volatile petroleum products should not be machine washed. If volatile cleaning fluids are used, care should be taken to ensure that the fluid is removed from the garment before placing in the machine.
- Never pull the power supply cable to remove the plug from the socket; always take hold of the plug itself.

- Never use the washing machine if the power supply cable, the control panel, the working surface or the base are damaged so that the inside of the washing machine is accessible.

### 1.4 CHILD SAFETY

- This washing machine is not intended for use by young children or infirm persons without supervision.
- Young children should be supervised to ensure that they do not play with the appliance.
- The packaging components (e.g. plastic film, polystyrene) can be dangerous to children - danger of suffocation! Keep them out of children's reach.
- Keep all detergents in a safe place out of children's reach.
- Make sure that children or pets do not climb into the drum.

### 1.5 CHILD SAFETY DEVICE

When you activate this device, you cannot close the door. This prevents children or pets to be locked in the drum.

- To activate this device, rotate the button (WITHOUT pressing it) inside the door clockwise until the groove is horizontal. If necessary use a coin.

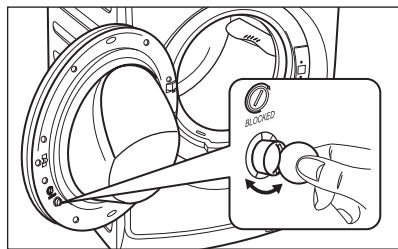

- To disable this device and restore the possibility of closing the door, rotate the button anti-clockwise until the groove is vertical.

## 2. PRODUCT DESCRIPTION

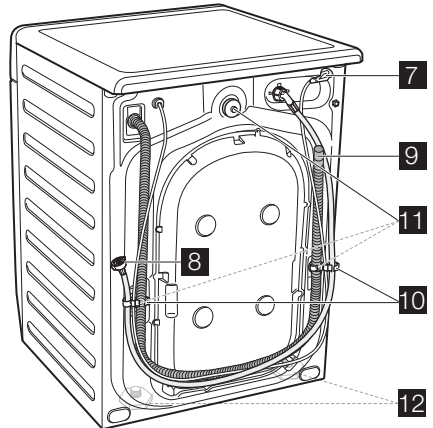
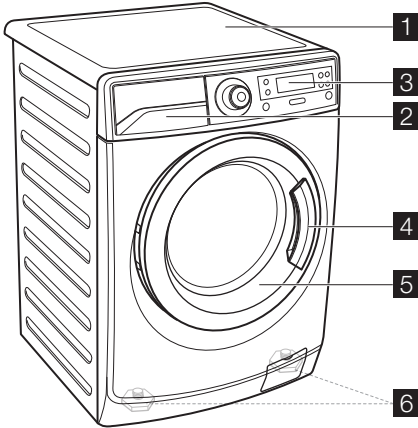

- 1** Worktop
- 2** Detergent/Softener Dispenser
- 3** Control Panel
- 4** Door Handle
- 5** Door
- 6** Level Adjustment Feet (Front)

- 7** Mains Cable
- 8** Water Inlet Hose
- 9** Water Drain Hose
- 10** Hose Support
- 11** Transit Bolts
- 12** Level Adjustment Feet (Back)

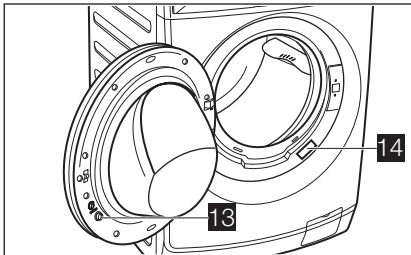

- 13** Child Safety Device
- 14** Rating Plate

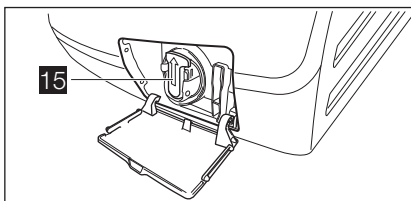

- 15** Drain Pump Filter

### ACCESSORIES

#### • Plastic caps



To close the holes on the rear side of the cabinet after the removal of the transit bolts.

#### • Plastic hose guide



To connect the drain hose on the edge of a sink.

#### • Spanner



- To remove the transit bolts.
- To adjust levelling legs.

## 3. CONTROL PANEL

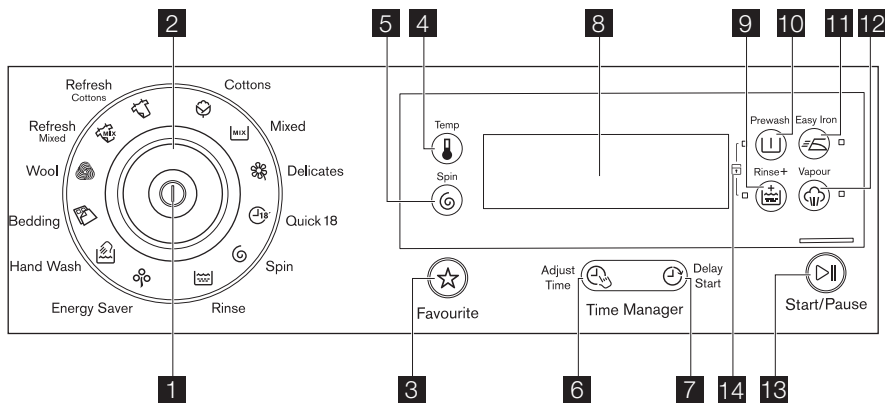

- |                                  |   |
|----------------------------------|---|
| <b>1</b> On/off Button           | <b>8</b> Display                          |
| <b>2</b> Program Knob            | <b>9</b> Rinse Plus Touchpad              |
| <b>3</b> Favourite Touchpad      | <b>10</b> Prewash Touchpad                |
| <b>4</b> Temperature Touchpad    | <b>11</b> Easy Iron Touchpad              |
| <b>5</b> Spin Selection Touchpad | <b>12</b> Vapour Touchpad                 |
| <b>6</b> Adjust Time Touchpad    | <b>13</b> Start/Pause Touchpad            |
| <b>7</b> Delay Start Touchpad    | <b>14</b> Child Lock Option (See Page 17) |

### 3.1 On/off Button ①

On/Off button is used to turn On and turn Off your washing machine.

### 3.2 Program Knob

Turn this knob to set a program. The related program indicator comes on. The buzzer sounds. (See page 10)

### 3.3 Favourite Touchpad ☆

Program settings that are frequently used can be saved (e.g. Cotton, 60°C, 1200 rpm, with Prewash and Rinse Plus).

To recall the favourite wash program, press 'Favourite' button.

You will get acknowledgement on the screen the Favourite program is loaded.

You can recall a favourite wash program ONLY when the washing machine is:

- in the program selection mode or
- running in a 'Delay Start' stage of a wash program.

Otherwise touching Favourite will have no effect.

The first time you touch Favourite button, a factory-set favourite wash program will be recalled. If you want to use this Favourite program shown on the display screen and not make any changes, touch 'Start/Pause' to begin your wash.

To re-program Favourite with your own selections and save them, proceed as follows:

1. Put machine in PAUSE mode.
2. Touch the Favourite button to enter re-programming mode. Confirmation of entering the re-programming mode shows on the screen.
3. Select your desired wash settings.
4. To EXIT re-programming mode without saving changes, touch 'Start/Pause' touchpad.
5. To save new program, touch 'Favourite' once.

### 3.4 Temperature Touchpad

Press this touchpad repeatedly to increase or decrease the wash temperature if you want your laundry to be washed at a temperature different from the one proposed by the washing machine.

### 3.5 Spin Selection Touchpad

Press this touchpad repeatedly to increase or decrease the spin speed, if you want your laundry to be spun at a speed different from the one proposed by the washing machine.



#### No Spin ---

No spin option eliminates all the spin phases and increase the number of rinses.

#### Extra Silent

By selecting this option, the machine will not drain the water of the last rinse to avoid wrinkling the laundry. All spinning phases are suppressed.



This washing cycle is very quiet, and can be selected at night or other appropriate times.

 The door stays locked with the water in the drum. To continue the cycle you must press  (Start/Pause).

#### Rinse Hold

By selecting this option the water of the last rinse is not emptied out and the drum turns regularly to prevent the laundry creases.

The door is still locked to indicate that the water must be emptied out.

 The door stays locked with the water in the drum. To continue the cycle you must press  (Start/Pause).

### 3.6 Adjust Time Touchpad

This option allows you to reduce washing time.

Press this touchpad repeatedly to decrease or return to default washing time.

This option will adjust the number of rinse according to selected washing time.

### 3.7 Delay Start Touchpad

This option makes it possible to delay the start of the program by 30 min, 60 min or 90 min and then by every hour from 2 to 20 hours.

The delay you have selected is indicated on the display. The end time will increase in order to show you the selected delay.

You must select this option after you have set the program and before you press the Start/Pause touchpad.

If you wish to add laundry in the machine during the delay time press Start/Pause touchpad to put the machine in pause mode. Add laundry, close the door and press Start/Pause touchpad again.

You can cancel the delay time at any moment, by pressing 'Delay Start' touchpad repeatedly till the display shows delay time '0', then press the Start/Pause touchpad.

### 3.8 Display

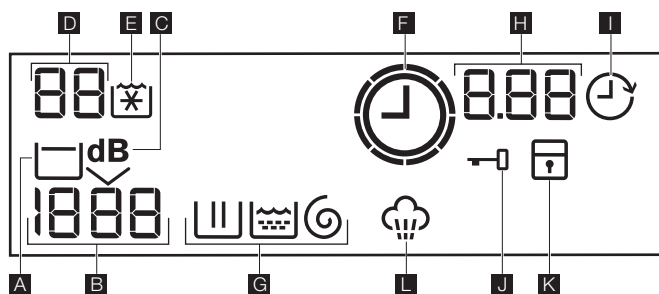

- |  |                                       |
|--|---------------------------------------|
| <b>A</b> Rinse hold icon               | <b>I</b> Delay start icon             |
| <b>B</b> Spin speed                    | <b>J</b> Door lock icon               |
| <b>C</b> Extra silent icon             | - It is on, you cannot open the door. |
| <b>D</b> Wash temperature              | - It is off, you can open the door.   |
| <b>E</b> Cold water icon               | <b>K</b> Child lock icon              |
| <b>F</b> Time manager icon             | <b>L</b> Vapour phase icon            |
| <b>G</b> Washing progress icon         |                                       |
| <b>H</b> Washing cycle time/delay time |                                       |

### 3.9 Rinse Plus Touchpad

This option is recommended for people who are allergic to detergents, and in areas where the water is very soft.

Press it to add rinsing phases to a program.

The indicator of this option comes on.

### 3.10 Prewash Touchpad

Select this option if you wish your laundry to be pre-washed before the main wash. Use this option for heavy soil.

The indicator of this option comes on. When you set this function, put the detergent into the "  " compartment. (Refer page 14-15)

This function increases the program duration.

### 3.11 Easy Iron Touchpad

When selecting this option the laundry is gently washed and spun to avoid creasing. In this way ironing is easier.

The indicator of this option comes on.

### 3.12 Vapour Touchpad

Select this option to add approximately 15-40 minutes of tumbling in vapour during the wash cycle. Vapour helps open fabric fibers up to allow laundry additives to release tough stains.

The indicator of this option comes on.

#### NOTE:

- Vapour may not necessarily be visible inside the drum during a vapour wash cycle. Vapour is created below the drum and allowed to naturally rise into the clothes.
- Vapour may not be present during the entire vapour wash cycle.
- Vapour function is more effective with half load.
- At the end of the Vapour cycle the clothes will be warmer, softer and detached from the drum.

 If Vapour option is selected, rinse temperatures will be elevated.

During a vapour cycle you may notice vapour exiting from the drain hose of the washing machine, this is normal there is no cause for alarm.

### 3.13 Start/Pause Touchpad

To start the selected program, press the 'Start/Pause'.

To interrupt a program which is running, press the 'Start/Pause' to pause the machine.

To restart the program from the point at which it was interrupted, press the 'Start/Pause' again.

If you have chosen a delayed start, after pressing 'Start/Pause' the machine will begin the countdown.

### 3.14 Buzzer Sounds











The buzzer sounds operate when:









- The program is completed.
- The appliance has a malfunction.

If you want to disable the buzzer sound (except for event of appliance malfunction), press "Rinse +" and "Vapour" touchpads at the same time for 6 seconds, and listen for 'BEEP, BEEP'.

To return to default configuration press these 2 touchpads at the same time for 6 seconds, and listen for 'BEEP'.

## 3.15 Programs + Options

Program; Temperature	Type of load; Max. weight of load	Cycle description	Options can be combined
 Cottons; 90 °C to  (Cold water)	White and coloured cotton with heavy level of soil; max. load 8.5 kg.	- Wash - Rinses - Long spin	Spin Reduction - 1200 to 400 rpm - No Spin - Rinse Hold - Extra Silent  Prewash, Easy Iron, Rinse +, Vapour <sup>1)</sup> , Adjust Time, Delay Start
 Mixed; 60 °C to  (Cold water)	Synthetic or mixed fabric items with normal level of soil; max. load 4 kg.	- Wash - Rinses - Short spin	Spin Reduction - 1200 to 400 rpm - No Spin - Rinse Hold - Extra Silent  Prewash, Easy Iron, Rinse +, Vapour <sup>1)</sup> , Adjust Time, Delay Start
 Delicates; 40 °C to  (Cold water)	Delicate fabrics as acrylics, viscose, polyester items with normal soil; max. load 4 kg	- Wash - Rinses - Short spin	Spin Reduction - 1200 to 400 rpm - No Spin - Rinse Hold - Extra Silent  Prewash, Rinse +, Vapour <sup>1)</sup> , Adjust Time, Delay Start
 Quick 18; 30 °C	Synthetic and mixed fabric items. Light soil and items to freshen up; max. load 1.5 kg	- Wash - Rinses - Short spin	Spin Reduction - 800 to 400 rpm - No Spin - Rinse Hold Delay Start
 Spin	To spin the laundry and drain the water in the drum; max. load 8.5 kg.	- Drain - Spin phase	Spin Reduction - 1200 to 400 rpm - No Spin Delay Start
 Rinse	To rinse and spin the laundry; max. load 8.5 kg.	- Three rinses with softener - Spin phase	Spin Reduction - 1200 to 400 rpm - No Spin - Rinse Hold Delay Start
 Energy Saver; 60 °C <sup>2)</sup> and 40 °C	White and colourfast, cotton with normal soil. Set this program to have a good washing results and decrease the energy consumption. The time of the washing program is extended; max. load 8.5 kg.	- Wash - Rinses - Long spin	Spin Reduction - 1200 to 400 rpm - No Spin - Rinse Hold  Prewash, Rinse +, Vapour <sup>1)</sup> , Adjust Time, Delay Start

Program; Temperature	Type of load; Max. weight of load	Cycle description	Options can be combined
 Hand Wash; 40 °C to  (Cold water)	Machine washable wool, hand washable woollen and delicate fabrics with hand washing '👉' care symbol; max. load 2 kg.	- Wash - Rinses - Short spin	Spin Reduction - 1000 to 400 rpm - No Spin - Rinse Hold - Extra Silent Delay Start
 Bedding 60 °C to  (Cold water)	Special program for one synthetic blanket, duvet, bedspread and so on; max. load 3 kg.	- Wash - Rinses - Long spin	Spin Reduction - 800 to 400 rpm - No Spin Vapour <sup>1)</sup> , Adjust Time, Delay Start
 Wool; 40 °C to  (Cold water)	Specially tested program for woollen garments bearing the 'Pure new wool, non-shrink, machine washable' label; max. load 2 kg.	- Wash - Rinses - Short spin	Spin Reduction - 1200 to 400 rpm - No Spin - Rinse Hold - Extra Silent Delay Start
 Refresh Mixed	Vapour program for synthetic or mixed fabric items. This cycle removes odours and helps to dewrinkle the laundry; max. load 1.5 kg.	- Clothes tumble in vapour	Delay Start
 Refresh Cottons	Vapour program for White and coloured cotton. This cycle removes odours and helps to dewrinkle the laundry; max. load 1.5 kg.	- Clothes tumble in vapour	Delay Start

1) Vapour option can be combined with temperature 90 to 40 °C only.

2) Energy Saver program with 60 °C option selected is recommended for a full load of normally soiled cottons, and is the water and energy rating label program.

## WOOLMARK CERTIFICATE



The wool wash cycle of this machine has been approved by The Woolmark Company for the washing of machine washable wool products provided that the products are washed according to the instructions on the garment label and those issued by the manufacturer of this washing machine. M1310

## 4. BEFORE FIRST USE

1. Ensure that the electrical and water connections comply with the installation instructions.
2. Put 2 litres of water in the detergent compartment for washing phase. This activates the drain system.
3. Select a Cottons cycle at 90 °C, without any laundry in the machine, to remove any manufacturing residue from the drum and tub. Pour 1/2 a measure of detergent into the dispenser drawer and start the machine.

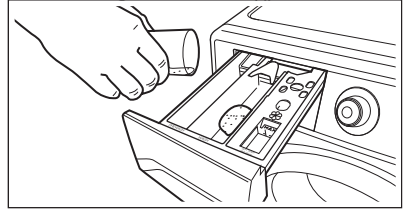
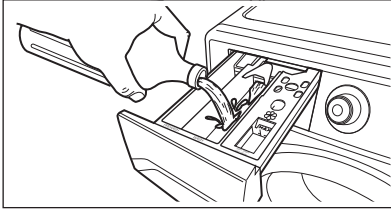

## 5. DAILY USE

- Connect the mains plug to the mains socket.
- Turn the water tap on.

### 5.1 Four Steps Start Up Guide

#### Step 1 - Setting A Program For Washing

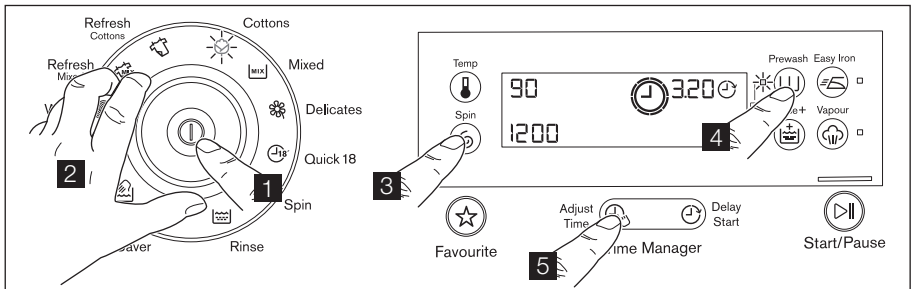

1. Press the On/Off button to turn on the washing machine.
  2. Turn the program selector dial to the required program.
    - The relevant light will light up.
    - The buzzer will sound.
    - The selector dial can be turned either clockwise or anticlockwise.
  3. Press the Temp button to set the temperature (e.g., 90°C).
  4. Press the Spin button to set the spin speed (e.g., 1200).
  5. Press the Start/Pause button to start the machine.
- Once you selected a wash program, the program selected will stay at that position for the whole of the wash.
  - The display shows the level of the Time Manager, the program duration and the indicators of the phases of the program.

- If you want your laundry to be spun or use temperature different from the one proposed by the washing machine,

press the Spin 'G' and the temperature 'H' touchpads repeatedly to change the spin speed and temperature.

- Press the option touchpads, if you want your laundry to be washed with special functions.

Different functions can be combined which is dependent on the program selected.

When these touchpads are pressed, the corresponding pilot lights come on. When they are pressed again, the pilot lights go out.

- If you want to reduce washing time, press the 'Adjust Time' touchpad repeatedly to reduce washing time.

If you want to delay the start of the washing program, press the 'Delay Start' touchpad repeatedly to choose your washing machine delay time.

## Step 2 - Loading The Laundry

-  Before loading the laundry, please make sure:

- Empty pockets.

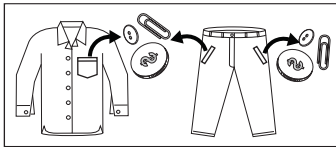

- Tie the cords.



- Fasten buttons.

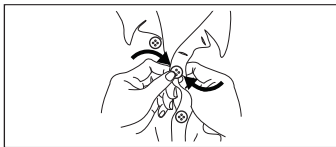

- Close zippers.

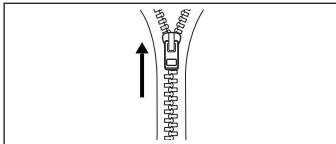

- Underwired bras must NOT be machine washed.

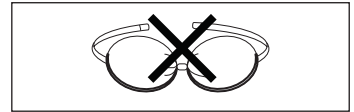

- Open the door by carefully pulling the door handle outwards.

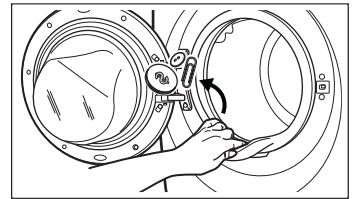

Check and remove objects (if there are any) that could be trapped in the fold.

- Place the laundry in the drum, one item at a time, shaking them out as much as possible.

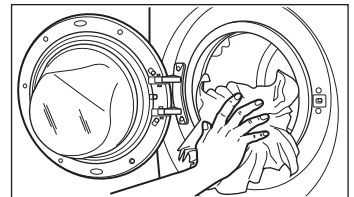

4. Make sure that no laundry remains between the seal and the door.

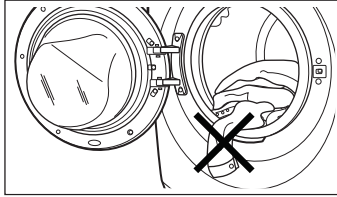



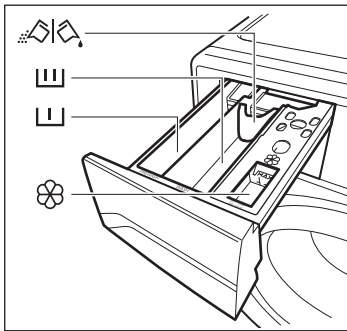

5. Close the door.

### Step 3 - Using Detergent And Additives

1. Detergent Dispenser Drawer



The detergent dispenser is divided into three compartments.

-  Detergent flap  
Flap for powder or liquid detergent.
-  Compartment 'MAIN WASH'  
This compartment is used for detergent on all programs.
-  Compartment 'PREWASH'  
This compartment is only used for detergent when a Prewash is selected.
-  Compartment 'SOFTENER'  
This compartment is used for fabric conditioner and starching agent.

Powder or liquid detergent.

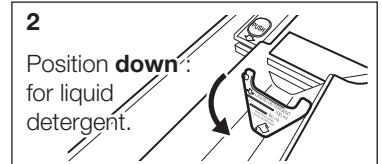
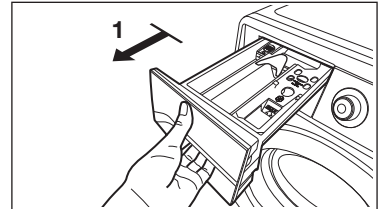

**2**  
Position **down** :  
for liquid  
detergent.



Position **up** :  
for powder  
detergent  
(factory setting).

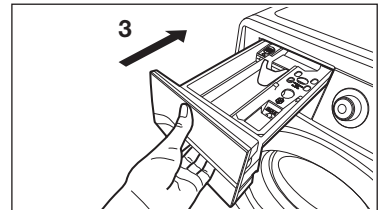



**i** **When you use the liquid detergent:**

- Do not use gelatinous or thick liquid detergents.

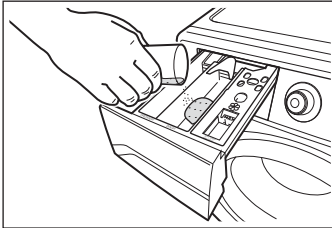
- Do not put more liquid than the maximum level.
  - Do not set the PREWASH phase.
  - Do not set the DELAY START.
2. Measure out the detergent and the fabric softener;
- Pull out the dispenser drawer until it stops.
  - Measure out the amount of detergent required, pour it into the main wash compartment (  ).



- If you wish to carry out the "Prewash" phase, pour it into the compartment marked .
- If required, pour fabric softener into the compartment marked  (the amount used must not exceed the "MAX" mark in the drawer).

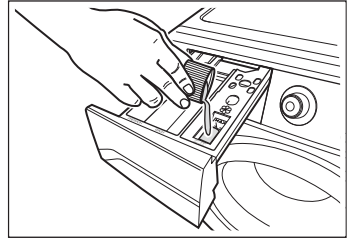

- Close the drawer gently.

## Step 4 - Starting a program

To start a program, press the Start/Pause (  ) touchpad, the corresponding pilot light will stop flashing and a default program duration will be displayed on the screen.



 After approx. 15 minutes from the start of a program:

- The appliance will automatically adjust the selected program duration according to the type and size of the load.
- The display will show adjusted program duration.

### ATTENTION!

If you turn the program selector dial to another program when the machine is working, the red Start/Pause pilot light will flash 3 times and the message 'Err' will appear on the display to indicate a wrong selection. The machine will not perform the new selected program.

## 5.2 Interruption Of A Program

- To pause press Start/ Pause. The indicator will start flashing.
- Press the Start/Pause again. The program will continue.

## 5.3 Changing A Program

Changing a running program is possible only by switching off the appliance.

- Press the 'On/Off' button to cancel the program and to turn off the appliance.
- Press the 'On/Off' button again to start the appliance. Now, you can set a new washing program.



The appliance will not drain the water.

## 5.4 Changing The Options

It is possible to change only some options after the program has started.

1. Press the touchpad Start/Pause. The indicator will start flashing.
2. Change the options.
3. Press Start/Pause again. The program will continue.

## 5.5 Opening The Door

While a program or the Delay Start is operating, the appliance door is locked and the display shows the indicator '—□'.

First set the machine to PAUSE by pressing the "Start/Pause" touchpad. Wait until the door lock indicator '—□' goes off, then the door can be opened.

If the door lock indicator '—□' does not disappear, this means that the machine is already heating and the water level is above the bottom edge of the door or the drum is turning. In this case the door CAN NOT be opened.

If you can not open the door **but you need to open it** you have to switch the machine off by pressing the 'On/Off' button to deactivate the appliance. After about 5 minutes the door can be opened.



### CAUTION!

**Pay attention to the water level and water temperature.**

## 5.6 At The End Of The Program

- The appliance stops automatically.
- The acoustic signal will operate.
- The display will show '□'.
- The indicator of the touchpad Start/Pause goes off.
- The door lock indicator '—□' goes off.
- Remove the laundry from the appliance. Make sure that the drum is empty.
- Keep the door ajar, to prevent the mildew and odours.
- Turn off the water tap.

## 5.7 When The Washing Program Is Completed, But There Is Water In The Drum

- The drum turns regularly to prevent the creases in the laundry.
- The door lock indicator '—□' is on. The door stays locked.

You must drain the water to open the door.

To drain the water:

1. Set the "Spin" program.
2. If necessary, decrease the spin speed.
3. Press the touchpad Start/Pause. The appliance will drain the water and spin.

4. When the program is completed and the door lock indicator '—' goes off, you can open the door.
5. Press the 'On/Off' button to deactivate the appliance.

## 5.8 AUTO Stand-by Option

The AUTO Stand-by option automatically deactivates the appliance to decrease the energy consumption when:

- You do not press any buttons for 5 minutes before you press "Start/Pause".

Press the "On/Off" button to activate the appliance again.

- After 5 minutes from the end of the washing program.

Press the "On/Off" button to activate the appliance again.

Turn the program knob to set a new cycle.

## 5.9 Child Lock Feature

Your appliance is provided with CHILD SAFETY LOCK which permits you to leave the appliance unsupervised with the door closed without having to worry that children might be injured by or cause damage to the appliance.

Set this option before pressing the Start/Pause and after having selected the required wash program.

This function remains enabled even after the appliance is switched off.

Setting Child Lock option:

- To activate the function, press 'Prewash' and 'Rinse +' touchpads at the same time until the display shows the symbol 'M

## 6. WASHING HINTS

### 6.1 Sorting The Laundry

Follow the wash code symbols on each garment label and the manufacturer's washing instructions. Sort the laundry as follows: whites, coloureds, synthetics, delicates, woollens.

### 6.2 Temperatures

90°C	For normally soiled white cottons and linen (e.g. teacloths, towels, tablecloths, sheets...).
60°C 50°C 40°C	For normally soiled, colourfast garments (e.g. shirts, night dresses, pyjamas...) in linen, cotton or synthetic fibres and for lightly soiled white cotton (e.g. underwear).
30°C Cold	For delicate items (e.g. net curtains), mixed laundry including synthetic fibres and woollens bearing the label pure new wool, machine washable, non-shrink.

### 6.3 Before Loading The Laundry

Never wash whites and coloureds together. Whites may lose their "whiteness" in the wash.

New coloured items may run in the first wash; they should therefore be washed separately the first time.

Make sure that no metal objects are left in the laundry (e.g. hair clips, safety pins, pins).

Button up pillowcases, close zip fasteners, hooks and poppers. Tie any belts or long tapes.

Remove persistent stains before washing.

Rub particularly soiled areas with a special detergent or detergent paste. Treat curtains with special care.

Remove hooks or tie them up in a bag or a net.

### 6.4 Maximum Loads

Recommended loads are indicated in the program charts. General rules:

Cotton, linen:	drum full but not too tightly packed;
Synthetics:	drum no more than half full;
Delicate fabrics and woollens:	drum no more than one third full.

Washing a maximum load makes the most efficient use of water and energy. For heavily soiled laundry, reduce the load size.

### 6.5 Removing Stains

Stubborn stains may not be removed by just water and detergent. It is therefore advisable to treat them prior to washing.

**Blood:** treat fresh stains with cold water. For dried stains, soak overnight in water with a special detergent then rub in the soap and water.

**Oil based paint:** moisten with benzene stain remover, lay the garment on a soft cloth and dab the stain; treat several times.

**Dried grease stains:** moisten with turpentine, lay the garment on a soft surface and dab the stain with the fingertips and a cotton cloth.

**Rust:** oxalic acid dissolved in hot water or a rust removing product used in cold water. Be careful with rust stains which are not recent since the cellulose structure will already have been damaged and the fabric tends to hole.

**Mould stains:** treat with bleach, rinse well (whites and fast coloureds only).

**Grass:** soap lightly and treat with bleach (whites and fast coloureds only).

**Ball point pen and glue:** moisten with acetone (\*), lay the garment on a soft cloth and dab the stain.

**Lipstick:** moisten with acetone (\*) as above, then treat stains with methylated spirits. Remove any residual marks from white fabrics with bleach.

**Red wine:** soak in water and detergent, rinse and treat with acetic or citric acid, then rinse. Treat any residual marks with bleach.

**Ink:** depending on the type of ink, moisten the fabric first with acetone (\*), then with acetic acid; treat any residual marks on white fabrics with bleach and then rinse thoroughly.

**Tar stains:** first treat with stain remover, methylated spirits or benzine, then rub with detergent paste.

(\*) do not use acetone on artificial silk.

## 6.6 Detergents and Additives

Good washing results also depend on the choice of detergent and use of the correct quantities to avoid waste and protect the environment.

Although biodegradable, detergents contain substances which, in large quantities, can upset the delicate balance of nature.

The choice of detergent will depend on the type of fabric (delicates, woollens, cottons, etc.), the colour, washing temperature and degree of soiling.

**Only low suds Front load washer detergents should be used in this appliance:**

- powder detergents for all types of fabric,
- powder detergents for delicate fabrics (60 °C max) and woollens,
- liquid detergents, preferably for low temperature wash program (60 °C max) for all types of fabric, or special for woollens only.

The detergent and any additives must be placed in the appropriate compartments of the dispenser drawer before starting the wash program.

Pour liquid detergent into the dispenser drawer compartment marked '  ' just before starting the program.

 If using concentrated powder or liquid detergents, a program without PREWASH must be selected.

Any fabric softener or starching additives must be poured into the compartment marked '⊗' before starting the wash program.

Follow the product manufacturer's recommendations on quantities to use and do not exceed the MAX mark in the detergent dispenser drawer.

**Do not spray stain pre-treatment products (e.g. Preen) on or near the machine, as it can attack plastic materials reducing its life.**

Use less detergent if:

- you are washing a small load,
- the laundry is lightly soiled,
- large amounts of foam form during washing.

## 6.7 Quantity Of Detergent To Be Used

The type and quantity of detergent will depend on the type of fabric, load size, degree of soiling and hardness of the water used.

Water hardness is classified in so-called "degrees" of hardness.

Information on hardness of the water in your area can be obtained from the relevant water supply company, or from your local authority.

Follow the product manufacturers' instructions on quantities to use.

Not enough washing powder causes:

































- the washload to turn grey,
- greasy clothes.

Too much washing powder causes:

- sudsing,
- reduced washing effect,
- inadequate rinsing.

# 7. INTERNATIONAL WASH CODE SYMBOLS

**i** These symbols appear on fabric labels, in order to help you choose the best way to treat your laundry.

<p><b>Energetic wash</b></p>   <p><b>Delicate wash</b></p>	 <p>Max. wash temperature 95 °C</p>	 <p>Max. wash temperature 60 °C</p> 	 <p>Max. wash temperature 40 °C</p>  	 <p>Max. wash temperature 30 °C</p> 	 <p>Hand wash</p>	 <p>DO NOT wash at all</p>	
 <p><b>Bleaching</b></p>	 <p>Bleach in cold water</p>			 <p>DO NOT bleach</p>			
 <p><b>Ironing</b></p>	 <p>Hot iron max. 200 °C</p>	 <p>Warm iron max. 150 °C</p>	 <p>Lukewarm iron max. 110 °C</p>	 <p>DO NOT iron</p>			
 <p><b>Dry cleaning</b></p>	 <p>Dry cleaning in all solvents</p>		 <p>Dry cleaning in perchlorethylene, petrol, pure alcohol, R 111 &amp; R 113</p>		 <p>Dry cleaning in petrol, pure alcohol and R 113</p>		 <p>DO NOT dry clean</p>
 <p><b>Drying</b></p>	 <p>Flat</p>	 <p>On the line</p>	 <p>On clothes hanger</p>	 <p>High temperature</p>  <p>Low temperature</p> <p>Tumble dry</p>	 <p>DO NOT tumble dry</p>		

## 8. CARE AND CLEANING



### WARNING!

You must DISCONNECT the appliance from the electricity supply, before you can carry out any cleaning or maintenance work.

### 8.1 External Cleaning

Clean the appliance only with soap and warm water. Fully dry all the surfaces.



### CAUTION!

**Do not use alcohol, solvents or chemical products.**

### 8.2 Descaling

The water we use normally contains lime. It is a good idea to periodically use a water softening powder in the machine.

Do this separately from any laundry washing, and according to the softening powder manufacturer's instructions.

This will help to prevent the formation of lime deposits.

### 8.3 After Each Wash

Leave the door open for a while. This helps to prevent mould and stagnant smells forming inside the appliance. Keeping the door open after a wash will also help to preserve the door seal.

### 8.4 Maintenance Wash

With the use of low temperature washes it is possible to get a build up of residues inside the drum.

We recommend that a maintenance wash be performed on a regular basis.

To run a maintenance wash:

- The drum should be empty of laundry.
- Select the hottest cotton wash program.
- Use a normal measure of detergent, must be a powder with biological properties.

### 8.5 Cleaning The Dispenser Drawer

The washing powder and additive dispenser drawer should be cleaned regularly.

Remove the drawer by pressing the catch downwards and by pulling it out. Flush it out under a tap, to remove any traces of accumulated powder.

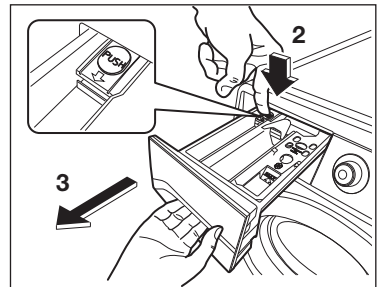
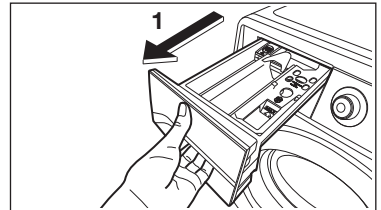

To aid cleaning, the top part of the additive compartment should be removed.

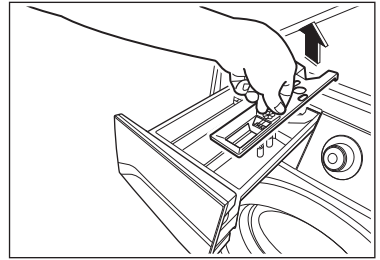

## 8.6 Cleaning The Drawer Recess

Having removed the drawer, use a small brush to clean the recess, ensuring that all washing powder residue is removed from the upper and lower part of the recess. Replace the drawer and run the rinse program without any clothes in the drum.

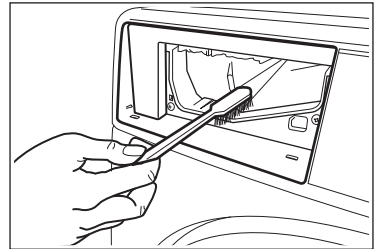

## 8.7 Cleaning The Pump

**i** Regularly examine the drain pump and make sure that it is clean.

Clean the pump if:

- The appliance does not drain the water.
- The drum cannot turn.
- The appliance makes an unusual noise because of the blockage of the drain pump.
- The display shows an alarm code because of the problem with water drain.



### **WARNING!**

1. Disconnect the mains plug from the mains socket.
2. Do not remove the filter while the appliance operates. Do not clean the drain pump if the water in the appliance is hot. The water must be cold before you clean the drain pump.

### To clean the drain pump:

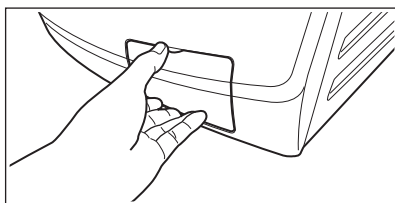

1. Open the drain pump door.

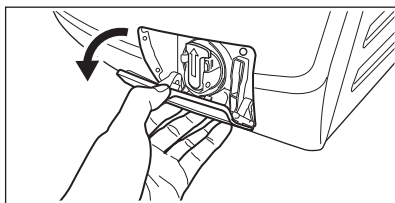

2. Pull the flap down.

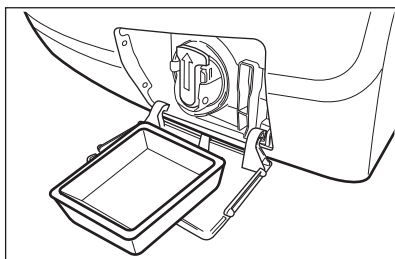

3. Put a container below the recess of the drain pump to collect the water that flows out.

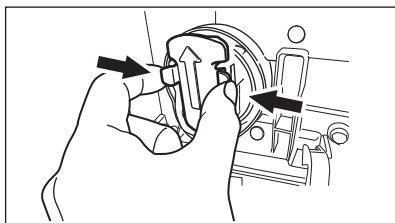

4. Press the two levers and pull forward the drainage duct to let the water flow out.

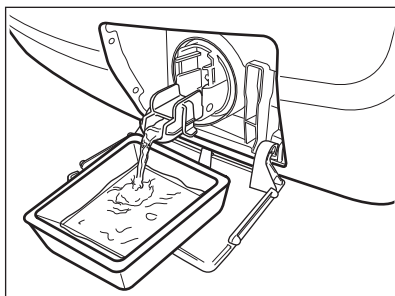

5. When the container is full of water, put the drainage duct back again and empty the container. Do steps 4 and 5 again and again until no more water flows out from the drain pump.

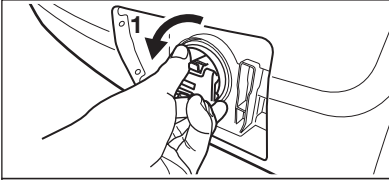

6. Pull back the drainage duct and turn the filter to remove it.

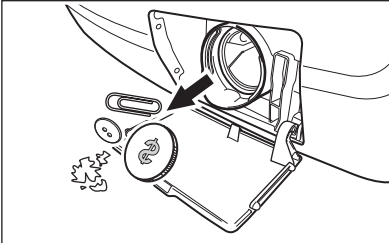
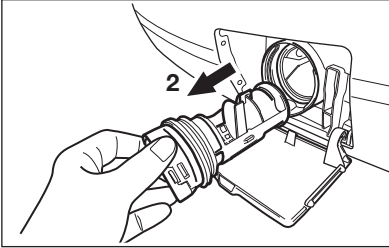

7. Remove fluff and objects from the pump (if there are any).

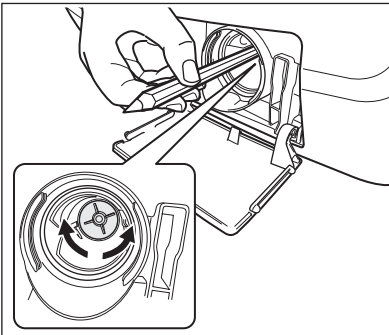

8. Make sure that the impeller of the pump can turn. If this does not occur, contact the service centre.

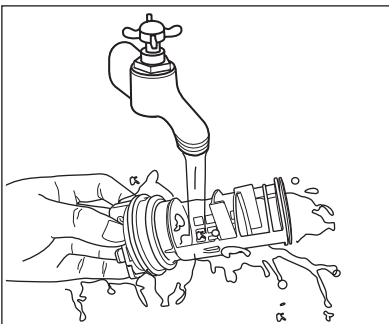

9. Clean the filter under the water tap.

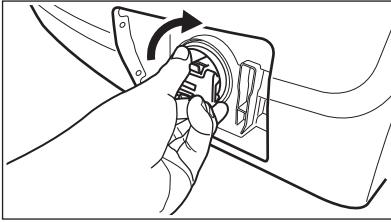

10. Put the filter back in the pump into the special guides. Make sure that you tighten correctly the filter to prevent leakages.

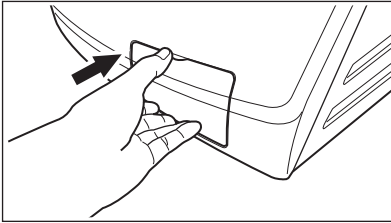

11. Put the flap back and close the drain pump door.

---

## 8.8 Cleaning The Water Inlet Filter

If your water is very hard or contains traces of lime deposit, the water inlet filter may become clogged.

It is therefore a good idea to clean it from time to time.

---

To clean the water inlet filters:

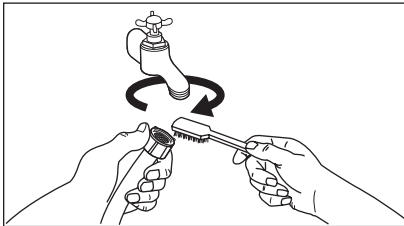

1. Close the water tap.
2. Remove the water inlet hose from the water tap.
3. Clean the filter in the inlet hose with a stiff brush.

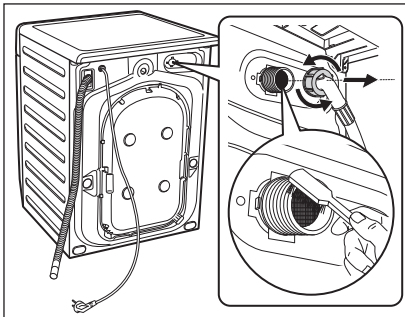

4. Remove the inlet hose behind the appliance.
5. Clean the filter in the valve with a stiff brush or a towel.

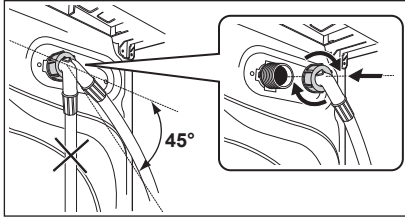

6. Install again the inlet hose. Make sure that the couplings are tight to prevent leakages.
7. Open the water tap.

## 8.9 The Dangers Of Freezing

If the machine is exposed to temperatures below 0°C, certain precautions should be taken.



### **Disconnect the mains plug from the mains socket.**

1. Turn off the water tap.
2. Unscrew the inlet hose.
3. Put a bowl below the recess of the drain pump to collect the water that flows out.

4. Pull forward the drainage duct and that of the inlet hose in a bowl placed on the floor and let water drain out.
5. Screw the water inlet hose back on and reposition the drainage duct.

When you intend to start the machine up again, make sure that the room temperature is above 0°C.

## 9. TROUBLESHOOTING

Certain problems are due to lack of simple maintenance or oversights, which can be solved easily without calling out an engineer. Before contacting your local Service Centre, please carry out the checks listed below.

During machine operation it is possible that the red Start/Pause pilot light flashes to indicate that the machine is not working.

Once the problem has been eliminated, press the Start/Pause button to restart the program. If after all checks, the problem persists, contact your local Service Centre.

<b>Malfunction</b>	<b>Possible cause</b>	<b>Solution</b>
<b>The washing machine does not start:</b>	<ul style="list-style-type: none"> <li>The door has not been closed. (Error code: E 40 )</li> </ul>	<ul style="list-style-type: none"> <li>Close the door firmly.</li> </ul>
	<ul style="list-style-type: none"> <li>The plug is not properly inserted in the power socket.</li> </ul>	<ul style="list-style-type: none"> <li>Insert the plug into the power socket.</li> </ul>
	<ul style="list-style-type: none"> <li>There is no power at the socket.</li> </ul>	<ul style="list-style-type: none"> <li>Please check your domestic electrical installation.</li> </ul>
	<ul style="list-style-type: none"> <li>The Start/Pause button has not been pressed.</li> </ul>	<ul style="list-style-type: none"> <li>Press the Start/Pause button.</li> </ul>
	<ul style="list-style-type: none"> <li>The delay start has been selected.</li> </ul>	<ul style="list-style-type: none"> <li>If the laundry are to be washed immediately, cancel the delay start.</li> </ul>
<b>The machine does not fill the water:</b>	<ul style="list-style-type: none"> <li>The water tap is closed. (Error code: E 10 )</li> </ul>	<ul style="list-style-type: none"> <li>Open the water tap.</li> </ul>
	<ul style="list-style-type: none"> <li>The inlet hose is squashed or kinked. (Error code: E 10 )</li> </ul>	<ul style="list-style-type: none"> <li>Check the inlet hose connection.</li> </ul>
	<ul style="list-style-type: none"> <li>The filter in the inlet hose is blocked. (Error code: E 10 )</li> </ul>	<ul style="list-style-type: none"> <li>Clean the water inlet hose filter.</li> </ul>
	<ul style="list-style-type: none"> <li>The door is not properly closed. (Error code: E 40 )</li> </ul>	<ul style="list-style-type: none"> <li>Close the door firmly.</li> </ul>
<b>The machine fills then empties immediately:</b>	<ul style="list-style-type: none"> <li>The end of the drain hose is too low. (Error code: E 10 )</li> </ul>	<ul style="list-style-type: none"> <li>Refer to relevant paragraph in “water drainage” section.</li> </ul>
<b>The machine does not empty and/or does not spin:</b>	<ul style="list-style-type: none"> <li>The drain hose is squashed or kinked. (Error code: E 20 )</li> </ul>	<ul style="list-style-type: none"> <li>Check the drain hose connection.</li> </ul>
	<ul style="list-style-type: none"> <li>The drain pump is clogged. (Error code: E 20 )</li> </ul>	<ul style="list-style-type: none"> <li>Clean the drain filter.</li> </ul>
	<ul style="list-style-type: none"> <li>The option ‘Rinse Hold’ or ‘No Spin’ has been selected.</li> </ul>	<ul style="list-style-type: none"> <li>Disable the option ‘Rinse Hold’ or ‘No Spin’</li> <li>Select spin program.</li> </ul>
	<ul style="list-style-type: none"> <li>The laundry is not evenly distributed in the drum.</li> </ul>	<ul style="list-style-type: none"> <li>Pause the machine and redistribute laundry manually.</li> </ul>

<b>Malfunction</b>	<b>Possible cause</b>	<b>Solution</b>
<b>There is water on the floor:</b>	<ul style="list-style-type: none"> <li>• Too much detergent or unsuitable detergent (creates too much foam) has been used.</li> </ul>	<ul style="list-style-type: none"> <li>• Reduce the detergent quantity or use another one.</li> </ul>
	<ul style="list-style-type: none"> <li>• Check whether there are any leaks from one of the inlet hose fittings. It is not always easy to see this as the water runs down the hose; check to see if it is damp.</li> </ul>	<ul style="list-style-type: none"> <li>• Check the water inlet hose connection.</li> </ul>
	<ul style="list-style-type: none"> <li>• The drain hose is damaged.</li> </ul>	<ul style="list-style-type: none"> <li>• Change it with a new one.</li> </ul>
<b>Unsatisfactory washing results:</b>	<ul style="list-style-type: none"> <li>• Too little detergent or unsuitable detergent has been used.</li> </ul>	<ul style="list-style-type: none"> <li>• Increase the detergent quantity or use another one.</li> </ul>
	<ul style="list-style-type: none"> <li>• Stubborn stains have not been treated prior to washing.</li> </ul>	<ul style="list-style-type: none"> <li>• Use commercial products to treat the stubborn stains.</li> </ul>
	<ul style="list-style-type: none"> <li>• The correct temperature was not selected.</li> </ul>	<ul style="list-style-type: none"> <li>• Check if you have selected the correct temperature.</li> </ul>
	<ul style="list-style-type: none"> <li>• Excessive laundry load.</li> </ul>	<ul style="list-style-type: none"> <li>• Reduce load.</li> </ul>
<b>The door will not open:</b>	<ul style="list-style-type: none"> <li>• The program is still running.</li> </ul>	<ul style="list-style-type: none"> <li>• Wait until the end of washing cycle.</li> </ul>
	<ul style="list-style-type: none"> <li>• The door lock has not been released.</li> </ul>	<ul style="list-style-type: none"> <li>• Wait about 5 minutes.</li> </ul>
	<ul style="list-style-type: none"> <li>• There is water in the drum.</li> </ul>	<ul style="list-style-type: none"> <li>• Select 'Spin' program to empty out the water.</li> </ul>
<b>The machine vibrates or is noisy:</b>	<ul style="list-style-type: none"> <li>• The transit bolts and packing have not been removed.</li> </ul>	<ul style="list-style-type: none"> <li>• Check the correct installation of the appliance.</li> </ul>
	<ul style="list-style-type: none"> <li>• The support feet have not been adjusted.</li> </ul>	<ul style="list-style-type: none"> <li>• Check the correct levelling of the appliance.</li> </ul>
	<ul style="list-style-type: none"> <li>• The laundry is not evenly distributed in the drum.</li> </ul>	<ul style="list-style-type: none"> <li>• Pause the machine and redistribute laundry manually.</li> </ul>
	<ul style="list-style-type: none"> <li>• There is very little laundry in the drum.</li> </ul>	<ul style="list-style-type: none"> <li>• Load more laundry.</li> </ul>
	<ul style="list-style-type: none"> <li>• Unstable floors eg. wooden floors.</li> </ul>	<ul style="list-style-type: none"> <li>• Refer to relevant paragraph in "Positioning" section.</li> </ul>
<b>Cycle time longer than displayed:</b>	<ul style="list-style-type: none"> <li>• Detergent over dose.</li> </ul>	<ul style="list-style-type: none"> <li>• Reduce the detergent quantity or use another one.</li> </ul>
	<ul style="list-style-type: none"> <li>• Machine unbalance.</li> </ul>	<ul style="list-style-type: none"> <li>• Redistribute laundry manually in the drum and start the spin phase again. Refer to relevant paragraph in "Positioning" section.</li> </ul>

Malfunction	Possible cause	Solution
<b>Spinning starts late or the machine does not spin:</b>	<ul style="list-style-type: none"> <li>The electronic unbalance detection device has cut in because the laundry is not evenly distributed in the drum.</li> </ul> <p>The laundry is redistributed by reverse rotation of the drum.</p> <p>This may happen several times before the unbalance disappears and normal spinning can resume. If, after 10 minutes, the laundry is still not evenly distributed in the drum, the machine will not spin. In this case, redistribute the load manually and select the spin program.</p>	<ul style="list-style-type: none"> <li>Pause the machine and redistribute laundry manually.</li> </ul>
<b>The machine makes an unusual noise:</b>	<ul style="list-style-type: none"> <li>Machine not installed properly.</li> </ul>	<ul style="list-style-type: none"> <li>Make sure the levelling of the appliance is correct. Refer to 'Installation'.</li> </ul>
	<ul style="list-style-type: none"> <li>Transit bolts or packaging not removed.</li> </ul>	<ul style="list-style-type: none"> <li>Make sure that the packaging and/or the transit bolts are removed. Refer to 'Installation'.</li> </ul>
	<ul style="list-style-type: none"> <li>The load may be too small.</li> </ul>	<ul style="list-style-type: none"> <li>Add more laundry in the drum.</li> </ul>
<b>No water is visible in the drum:</b>	<ul style="list-style-type: none"> <li>Machines based on modern technology operate very economically using very little water without affecting performance.</li> </ul>	



If you are unable to identify or solve the problem, contact our service centre.

Before telephoning, make a note of the model, serial number and purchase date of your machine: the Service Centre will require this information.

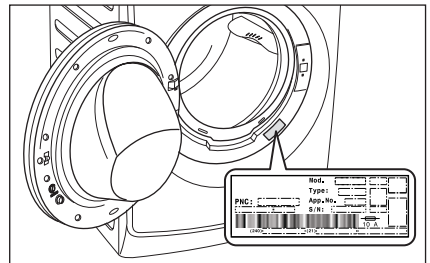

## 10. TECHNICAL DATA

<b>Dimensions</b> (Width / Height / Depth)	59.6 X 84.8 X 66.5 cm	
<b>Power supply</b> (Voltage / Frequency)	220-240 V / 50 Hz	
<b>Total power absorbed</b>	2200 W	
<b>Minimum fuse protection</b>	10 A	
<b>Water supply pressure</b> (Maximum / Minimum)	0.8 MPa / 0.05 MPa	
<b>Maximum load</b>	Cottons	8.5 Kg
	Mixed	4 Kg
	Delicates	4 Kg
	Quick 18	1.5 Kg
	Rinse	8.5 Kg
	Spin	8.5 Kg
	Energy Server	8.5 Kg
	Hand Wash	2 Kg
	Bedding	3 Kg
	Wool	2 Kg
Refresh Cottons	1.5 Kg	
Refresh Mixed	1.5 Kg	
<b>Spin speed</b> (Maximum / Minimum)	1200 rpm / 400 rpm	

# 11 .INSTALLATION

## 11.1 Unpacking



**CAUTION!**  
All transit bolts and packing must be removed before using the appliance.

You are advised to keep all transit devices so that they can be refitted if the machine ever has to be transported again.

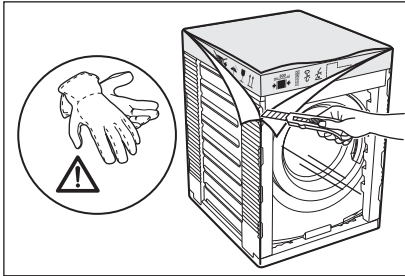

1. Use gloves. Remove the external film. If necessary, use a cutter.

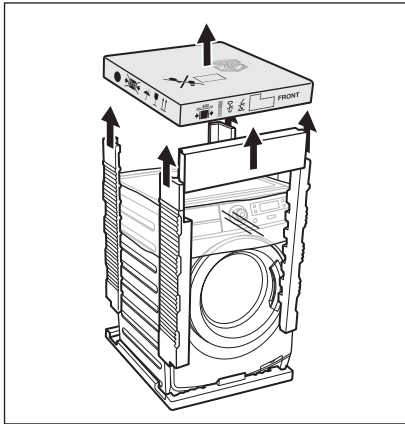

2. Remove the cardboard top.
3. Remove the polystyrene packaging materials.
4. Remove the plastic bag which cover the machine.

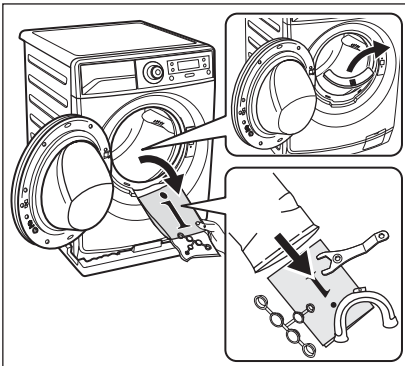

5. Open the door. Remove the polystyrene piece from the door seal and all the items from the drum.

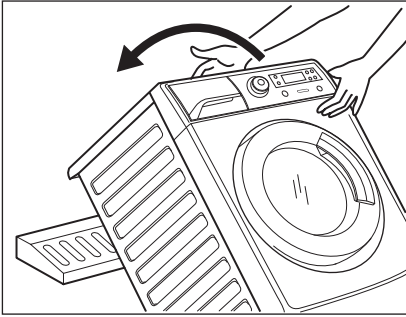

6. Put one of the polystyrene packaging elements on the floor behind the appliance. Carefully put down the appliance with the rear side on it. Make sure not to damage the hoses.

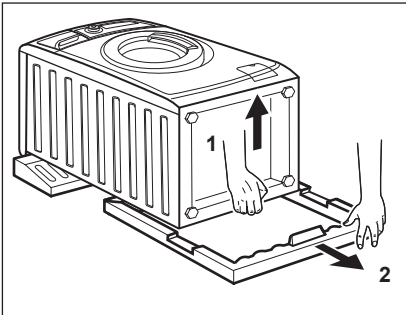

7. Remove the polystyrene base.  
8. Pull up the appliance in vertical position.

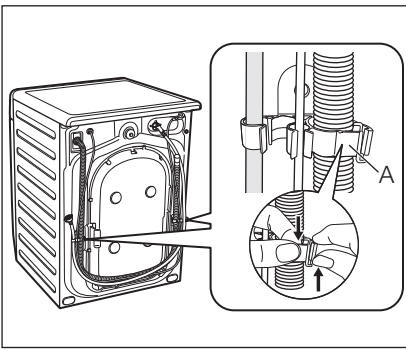

9. Remove the power supply cable and the drain and inlet hoses from the hose holders (A) on the rear of the appliance.

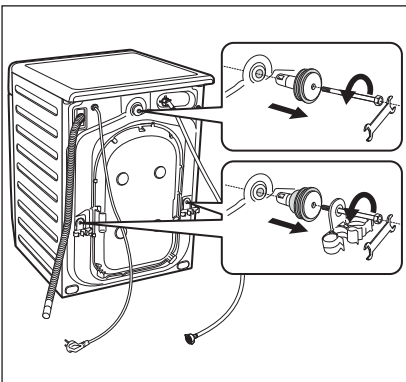

10. Remove the three bolts. Use the key supplied with the appliance.  
11. Pull out the plastic spacers.

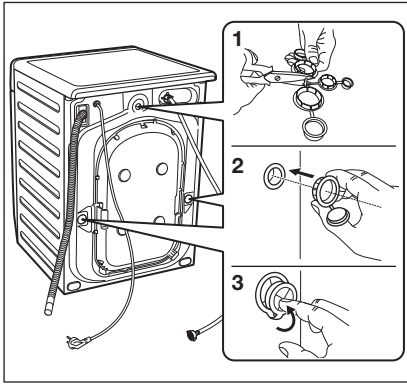

12. Put the plastic caps in the holes. You can find these caps in the user manual bag.

## 11.2 Positioning

**It is important that your washing machine stands firm and level on the floor to ensure correct operation.**

That the appliance must not be installed behind a lockable door, a sliding door or a door with a hinge on the opposite side to that of the washing machine door is restricted.

Use a spirit level on the top and side of the washing machine to check the levels.

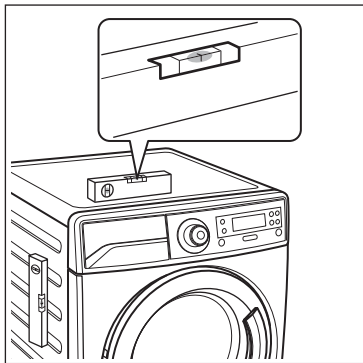

If you do not have a spirit level, as a guide use the edge of a door frame, cupboard or bench to check that the washing machine is level.

Loosen or tighten the feet to adjust the level. A correct adjustment of the appliance level prevents the vibration, noise and the movement of the appliance when in operation.

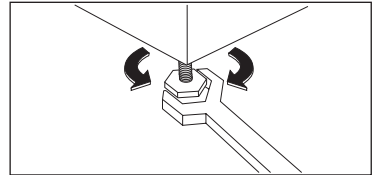

When the washing machine is levelled, try to rock it from corner to corner. If it does rock, adjust the legs again until it is levelled and does not rock.

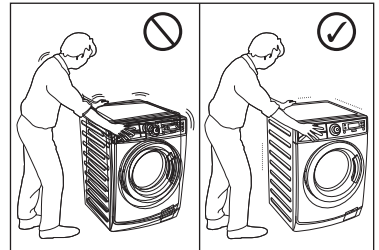

Never place cardboard, wood or similar materials under the machine to compensate for any unevenness in the floor.

Install the machine on a flat hard floor. Make sure that air circulation around the machine is not impeded by carpets, rugs etc.

Check that the machine does not touch the wall or cupboard units.

### 11.3 Water Inlet

Connect the water inlet hose to a tap with 3/4" BSP thread.

Use the hose supplied with the washing machine. **DO NOT USE OLD HOSES.**

The other end of the inlet hose which connects to the machine can be turned in any direction.

Simply loosen the fitting, rotate the hose and retighten the fitting, making sure there are no water leaks.

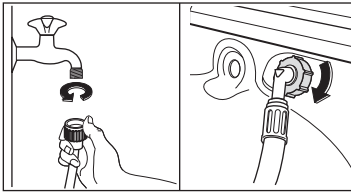

The inlet hose must not be lengthened. If it is too short and you do not wish to move the tap, you will have to purchase a new, longer hose specially designed for this type of use.

### 11.4 Water Drainage

The end of the drain hose can be positioned in three ways:

Hooked over the edge of a sink using the plastic hose guide supplied with the machine.

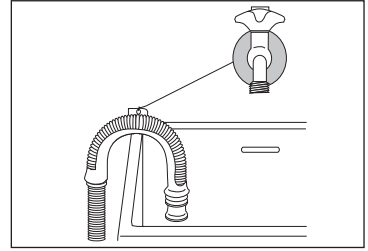

In this case, make sure the end cannot come unhooked when the machine is emptying.

This could be done by tying it to the tap with a piece of string or attaching it to the wall.

In a sink drain pipe branch. This branch must be above the trap so that the bend is at least 60 cm above the ground.

Directly into a drain pipe at a height of not less than 60 cm and not more than 90 cm.

The end of the drain hose must always be ventilated, i.e. the inside diameter of the drain pipe must be larger than the outside diameter of the drain hose.

The drain hose must not be kinked. Run it along the floor; only the part near the drainage point must be raised.

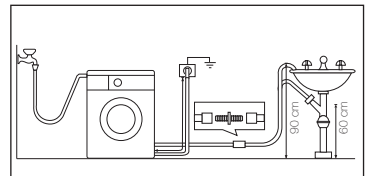

For the correct functioning of the machine the drain hose must remain hooked on the proper support piece situated on the top part of back side of the appliance.

## 11.5 Electrical Connection

This machine is designed to operate on a 220-240 V, single-phase, 50 Hz supply.

**“An incorrect power supply may void your warranty.”**

Check that your domestic electrical installation can take the maximum load required (2.2 kW), also taking into account any other appliances in use.



**CAUTION!**  
**Connect the machine to an earthed socket outlet.**

The manufacturer declines any responsibility for damage or injury through failure to comply with the above safety precaution.

Should the appliance power supply cable need to be replaced, this shall be carried out by our Service Centre.

When the appliance is installed the power supply cable must be easily accessible.

If this appliance is supplied from a cord extension set or electrical portable outlet device, the cord extension set or electrical portable device must be positioned so that it is not subject to splashing or ingress of moisture.

---

## 12. ENVIRONMENT CONCERNS

### 12.1 Packaging Materials



The materials marked with the symbol  are recyclable.

>PE<=polyethylene  
>PS<=polystyrene  
>PP<=polypropylene

This means that they can be recycled by disposing of them properly in appropriate collection containers.

### 12.2 Old Machine

Use authorised disposal sites for your old appliance. Help to keep your country tidy!

The symbol  on the product or on its packaging indicates that this product may not be treated as household waste.

Instead it shall be handed over to the applicable collection point for the recycling of electrical and electronic equipment.

By ensuring this product is disposed of correctly, you will help prevent potential negative consequences for the environment and human health, which could otherwise be caused by inappropriate waste handling of this product.

For more detailed information about recycling of this product, please contact your local city office, your household waste disposal service or the shop where you purchased the product.

### 12.3 Ecological Hints

To save water, energy and to help protect the environment, we recommend that you follow these tips:

- Normally soiled laundry may be washed without prewashing in order to save detergent, water and time (the environment is protected too!).
- The machine works more economically if it is fully loaded.
- With adequate pre-treatment, stains and limited soiling can be removed; the laundry can then be washed at a lower temperature.
- Measure out detergent according to the water hardness, the degree of soiling and the quantity of laundry being washed.

# NOTE

# Electrolux Warranty

FOR SALES IN AUSTRALIA AND NEW ZEALAND  
APPLIANCE: WASHING MACHINE

**This document sets out the terms and conditions of the product warranties for Electrolux Appliances. It is an important document. Please keep it with your proof of purchase documents in a safe place for future reference should you require service for your Appliance.**

1. In this warranty
  - (a) 'acceptable quality' as referred to in clause 10 of this warranty has the same meaning referred to in the ACL;
  - (b) 'ACL' means Trade Practices Amendment (Australian Consumer Law) Act (No.2) 2010;
  - (c) 'Appliance' means any Electrolux product purchased by you accompanied by this document;
  - (d) 'ASC' means Electrolux' authorised serviced centres;
  - (e) 'Electrolux' means Electrolux Home Products Pty Ltd of 163 O'Riordan Street, Mascot, NSW 2020, ABN 51 004 762 341 in respect of Appliances purchased in Australia and Electrolux (NZ) Limited of 3-5 Niall Burgess Road, Mount Wellington, in respect of Appliances purchased in New Zealand;
  - (f) 'major failure' as referred to in clause 10 of this warranty has the same meaning referred to in the ACL, and includes a situation when an Appliance cannot be repaired or it is uneconomic for Electrolux, at its discretion, to repair an Appliance during the Warranty Period;
  - (g) 'Warranty Period' means:
    - (i) where the Appliance is used for personal, domestic or household use (i.e. normal single family use) as set out in the instruction manual, the Appliance is warranted against manufacturing defects in Australia for 24 months and in New Zealand for 24 months, following the date of original purchase of the Appliance;
    - (ii) where the Appliance is used for commercial purposes (including being used to directly assist a business or where the Appliance is used in a multi-family communal or share type environment), the Appliance will then be warranted against manufacturing defects in Australia for 3 months and in New Zealand for 3 months, following the date of original purchase of the Appliance.
  - (h) 'you' means the purchaser of the Appliance not having purchased the Appliance for re-sale, and 'your' has a corresponding meaning.
2. This warranty only applies to Appliances purchased and used in Australia or New Zealand and is in addition to (and does not exclude, restrict, or modify in any way) any non-excludable statutory warranties in Australia or New Zealand.
3. During the Warranty Period Electrolux or its ASC will, at no extra charge if your Appliance is readily accessible for service, without special equipment and subject to these terms and conditions, repair or replace any parts which it considers to be defective. Electrolux or its ASC may use remanufactured parts to repair your Appliance. You agree that any replaced Appliances or parts become the property of Electrolux. This warranty does not apply to light globes, batteries, filters or similar perishable parts.
4. Parts and Appliances not supplied by Electrolux are not covered by this warranty.
5. You will bear the cost of transportation, travel and delivery of the Appliance to and from Electrolux or its ASC. If you reside outside of the service area, you will bear the cost of:
  - (a) travel of an authorised representative;
  - (b) transportation and delivery of the Appliance to and from Electrolux or its ASC.

In all instances, unless the Appliance is transported by Electrolux or an Electrolux authorised representative, the Appliance is transported at the owner's cost and risk while in transit to and from Electrolux or its ASC.

6. Proof of purchase is required before you can make a claim under this warranty.
7. You may not make a claim under this warranty unless the defect claimed is due to faulty or defective parts or workmanship. Electrolux is not liable in the following situations (which are not exhaustive):
  - (a) the Appliance is damaged by:
    - (i) accident
    - (ii) misuse or abuse, including failure to properly maintain or service
    - (iii) normal wear and tear
    - (iv) power surges, electrical storm damage or incorrect power supply
    - (v) incomplete or improper installation
    - (vi) incorrect, improper or inappropriate operation
    - (vii) insect or vermin infestation
    - (viii) failure to comply with any additional instructions supplied with the Appliance;
  - (b) the Appliance is modified without authority from Electrolux in writing;
  - (c) the Appliance's serial number or warranty seal has been removed or defaced;
  - (d) the Appliance was serviced or repaired by anyone other than Electrolux, an authorised repairer or ASC.
8. This warranty, the contract to which it relates and the relationship between you and Electrolux are governed by the law applicable where the Appliance was purchased. Where the Appliance was purchased in New Zealand for business purposes the Consumer Guarantee Act does not apply.
9. To the extent permitted by law, Electrolux excludes all warranties and liabilities (other than as contained in this document) including liability for any loss or damage whether direct or indirect arising from your purchase, use or non use of the Appliance.
10. For Appliances and services provided by Electrolux in Australia, the Appliances come with a guarantee by Electrolux that cannot be excluded under the Australian Consumer Law. You are entitled to a replacement or refund for a major failure and for compensation for any other reasonably foreseeable loss or damage. You are also entitled to have the Appliance repaired or replaced if the Appliance fails to be of acceptable quality and the failure does not amount to a major failure. The benefits to you given by this warranty are in addition to your other rights and remedies under a law in relation to the Appliances or services to which the warranty relates.
11. At all times during the Warranty Period, Electrolux shall, at its discretion, determine whether repair, replacement or refund will apply if an Appliance has a valid warranty claim applicable to it.
12. For Appliances and services provided by Electrolux in New Zealand, the Appliances come with a guarantee by Electrolux pursuant to the provisions of the Consumer Guarantees Act, the Sale of Goods Act and the Fair Trading Act.
13. To enquire about claiming under this warranty, please follow these steps:
  - (a) carefully check the operating instructions, user manual and the terms of this warranty;
  - (b) have the model and serial number of the Appliance available;
  - (c) have the proof of purchase (eg an invoice) available;
  - (d) telephone the numbers shown below.
14. You accept that if you make a warranty claim, Electrolux and its ASC may exchange information in relation to you to enable Electrolux to meet its obligations under this warranty.

### Important Notice

Before calling for service, please ensure that the steps listed in point 13 above have been followed.

<p><b>FOR SERVICE</b> or to find the address of your nearest state service centre in Australia <b>PLEASE CALL 13 13 49</b> <small>For the cost of a local call (Australia only)</small></p>	<p><b>SERVICE AUSTRALIA</b>  ELECTROLUX HOME PRODUCTS <a href="http://www.electrolux.com.au">www.electrolux.com.au</a></p>	<p><b>FOR SPARE PARTS</b> or to find the address of your nearest state spare parts centre in Australia <b>PLEASE CALL 13 13 50</b> <small>For the cost of a local call (Australia only)</small></p>
<p><b>FOR SERVICE</b> or to find the address of your nearest authorised service centre in New Zealand <b>FREE CALL 0800 10 66 10</b> <small>(New Zealand only)</small></p>	<p><b>SERVICE NEW ZEALAND</b>  ELECTROLUX HOME PRODUCTS <a href="http://www.electrolux.co.nz">www.electrolux.co.nz</a></p>	<p><b>FOR SPARE PARTS</b> or to find the address of your nearest state spare parts centre in New Zealand <b>FREE CALL 0800 10 66 20</b> <small>(New Zealand only)</small></p>

[www.electrolux.com/shop](http://www.electrolux.com/shop)



807209702-E-142013

