

THANK YOU for purchasing this high-quality product. Register your built-in oven at [www.jennair.com](http://www.jennair.com). In Canada, register your built-in oven at [www.jennair.ca](http://www.jennair.ca).

For future reference, please make a note of your product model and serial numbers. These can be located on the right-hand side underneath the control panel.

Model Number \_\_\_\_\_ Serial Number \_\_\_\_\_

Para una versión de estas instrucciones en español, visite [www.jennair.com](http://www.jennair.com).

Deberá tener a mano el número de modelo y de serie. Pueden encontrarse del lado derecho debajo del panel de control.

## Table of Contents

<b>BUILT-IN OVEN SAFETY</b> .....	<b>2</b>
<b>PARTS AND FEATURES</b> .....	<b>3</b>
<b>FEATURE GUIDE</b> .....	<b>4</b>
Touch Panel .....	5
Display .....	5
Display Navigation .....	5
Menu Demonstrations .....	5
Kitchen Timer .....	7
Tones/Sounds .....	7
Tools .....	7
Button Lock .....	8
Oven Temperature Control .....	8
Sabbath Mode .....	8
<b>OVEN USE</b> .....	<b>9</b>
Aluminum Foil .....	9
Position Racks and Bakeware .....	10
Roll-Out Extension Rack .....	10
Bakeware .....	11
Oven Vents .....	12
Preheating and Oven Temperature .....	12
Baking and Roasting .....	12
Broiling .....	12
Convection .....	13
Convection Bake .....	13
Convection Roast .....	13
Convection Broil .....	13
Proofing Bread .....	13
Temperature Probe .....	14
Timed Cooking .....	14
<b>OVEN CARE</b> .....	<b>15</b>
Self-Cleaning Cycle .....	15
General Cleaning .....	15
Oven Lights .....	16
Oven Door .....	16
<b>TROUBLESHOOTING</b> .....	<b>17</b>
<b>ACCESSORIES</b> .....	<b>18</b>
<b>WARRANTY</b> .....	<b>19</b>

# Built-In Oven Safety

## Your safety and the safety of others are very important.

We have provided many important safety messages in this manual and on your appliance. Always read and obey all safety messages.



This is the safety alert symbol.

This symbol alerts you to potential hazards that can kill or hurt you and others.

All safety messages will follow the safety alert symbol and either the word "DANGER" or "WARNING."

These words mean:

**⚠ DANGER**

**You can be killed or seriously injured if you don't immediately follow instructions.**

**⚠ WARNING**

**You can be killed or seriously injured if you don't follow instructions.**

All safety messages will tell you what the potential hazard is, tell you how to reduce the chance of injury, and tell you what can happen if the instructions are not followed.

## IMPORTANT SAFETY INSTRUCTIONS

**WARNING:** To reduce the risk of fire, electrical shock, injury to persons, or damage when using the oven, follow basic precautions, including the following:

- Proper Installation – Be sure the oven is properly installed and grounded by a qualified technician.
- Never Use the Oven for Warming or Heating the Room.
- Do Not Leave Children Alone – Children should not be left alone or unattended in area where oven is in use. They should never be allowed to sit or stand on any part of the oven.
- Wear Proper Apparel – Loose-fitting or hanging garments should never be worn while using the oven.
- User Servicing – Do not repair or replace any part of the oven unless specifically recommended in the manual. All other servicing should be referred to a qualified technician.
- Storage in Oven – Flammable materials should not be stored in an oven.
- Do Not Use Water on Grease Fires – Smother fire or flame or use dry chemical or foam-type extinguisher.
- Use Only Dry Potholders – Moist or damp potholders on hot surfaces may result in burns from steam. Do not let potholder touch hot heating elements. Do not use a towel or other bulky cloth.
- Use Care When Opening Door – Let hot air or steam escape before removing or replacing food.
- Do Not Heat Unopened Food Containers – Build-up of pressure may cause container to burst and result in injury.

- Keep Oven Vent Ducts Unobstructed.
- Placement of Oven Racks – Always place oven racks in desired location while oven is cool. If rack must be moved while oven is hot, do not let potholder contact hot heating element in oven.
- DO NOT TOUCH HEATING ELEMENTS OR INTERIOR SURFACES OF OVEN – Heating elements may be hot even though they are dark in color. Interior surfaces of an oven become hot enough to cause burns. During and after use, do not touch, or let clothing or other flammable materials contact heating elements or interior surfaces of oven until they have had sufficient time to cool. Other surfaces of the oven may become hot enough to cause burns – among these surfaces are oven vent openings and surfaces near these openings, oven doors, and windows of oven doors.

### For self-cleaning ovens:

- Do Not Clean Door Gasket – The door gasket is essential for a good seal. Care should be taken not to rub, damage, or move the gasket.
- Do Not Use Oven Cleaners – No commercial oven cleaner or oven liner protective coating of any kind should be used in or around any part of the oven.
- Clean Only Parts Listed in Manual.
- Before Self-Cleaning the Oven – Remove broiler pan and other utensils.

## SAVE THESE INSTRUCTIONS

State of California Proposition 65 Warnings:

**WARNING:** This product contains one or more chemicals known to the State of California to cause cancer.

**WARNING:** This product contains one or more chemicals known to the State of California to cause birth defects or other reproductive harm.

# Parts and Features

This manual covers several models. Your model may have some or all of the items listed. Refer to this manual or the Frequently Asked Questions (FAQs) section of our website at [www.jennair.com](http://www.jennair.com) for more detailed instructions. In Canada, refer to the Customer Service Section at [www.jennair.ca](http://www.jennair.ca).

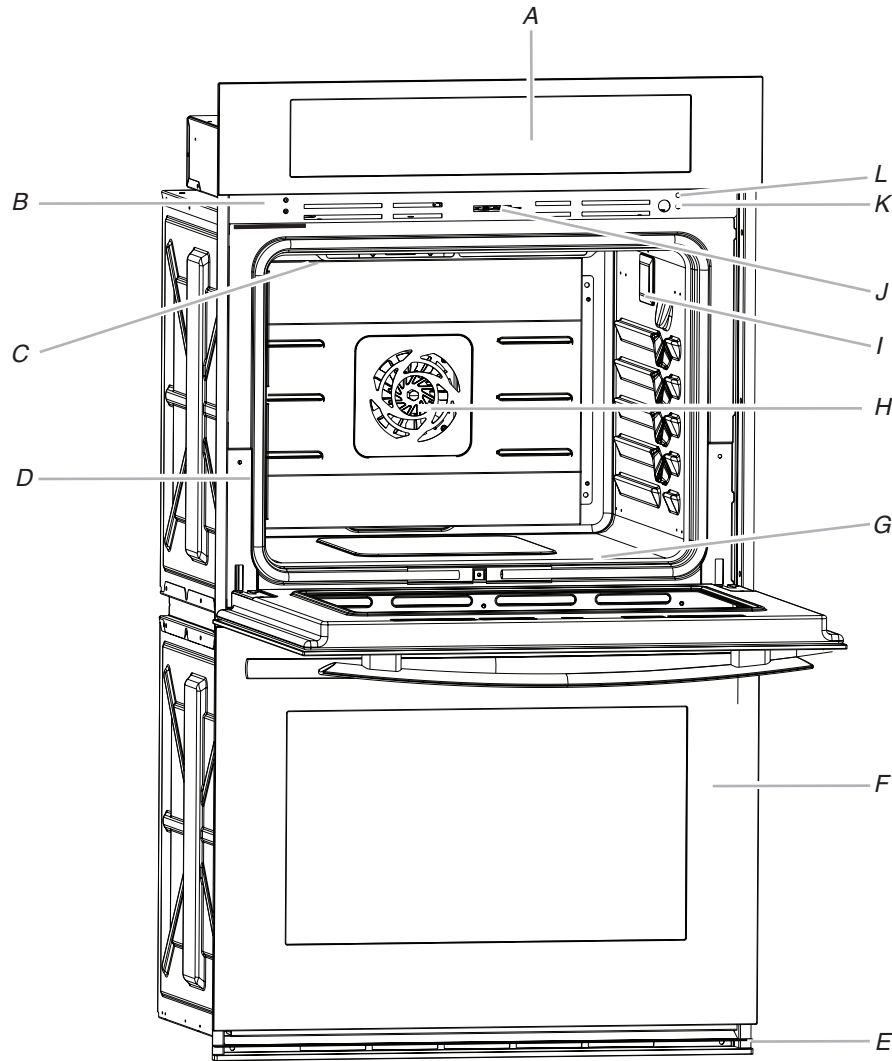

- A. Electronic oven control
- B. Oven vent
- C. Broil elements
- D. Gasket
- E. Bottom vent
- F. Lower oven (on double oven models)
- G. Hidden bake element

- H. Convection element and fan
- I. Oven lights (left side, not shown)
- J. Oven door lock latch
- K. Oven light switch
- L. Model and serial number plate  
(on right-hand side underneath  
the control panel)

- Parts and Features not shown**
- Temperature probe jack
  - Temperature probe
  - Racks

# Feature Guide

This manual covers several models. Your model may have some or all of the items listed. Refer to this manual or the Frequently Asked Questions (FAQs) section of our website at [www.jennair.com](http://www.jennair.com) for more detailed instructions. In Canada, refer to the Customer Service Section at [www.jennair.ca](http://www.jennair.ca).

## Single Oven:

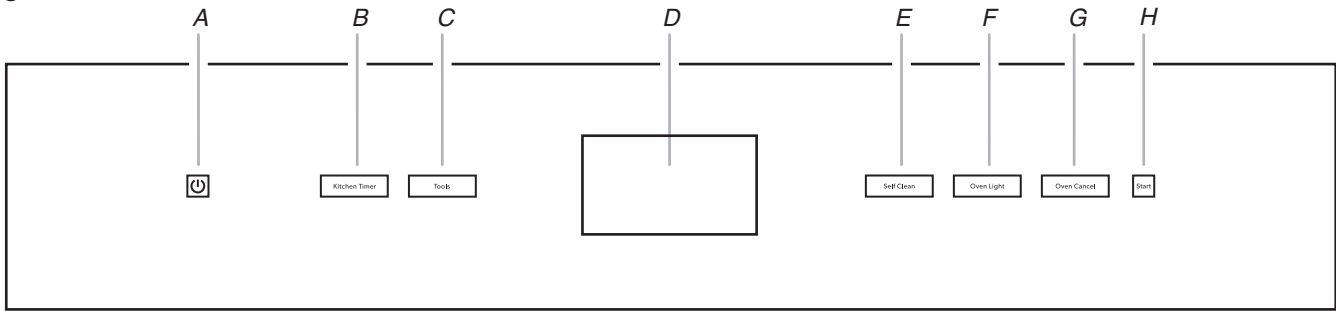

- A. Power
- B. Kitchen timer
- C. Tools
- D. Display
- E. Self clean
- F. Oven light
- G. Oven cancel
- H. Start

## Double Oven:

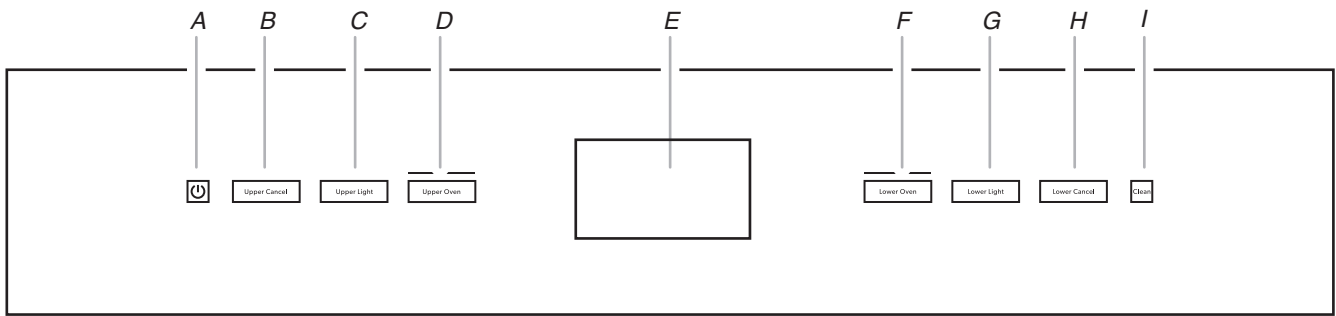

- A. Power
- B. Upper cancel
- C. Upper light
- D. Upper oven
- E. Display
- F. Lower oven
- G. Lower light
- H. Lower cancel
- I. Clean

KEYPAD	FEATURE	INSTRUCTIONS
<b>POWER</b> 	<b>Power</b>	Touch the Power keypad to turn the oven display on and off.
<b>OVEN LIGHT</b> <b>UPPER LIGHT</b> <b>LOWER LIGHT</b>	<b>Oven cavity light</b>	The desired oven light is controlled by a touch keypad on the oven control panel. While the oven door is closed, touch the desired Oven Light to turn the oven lights on and off. When the oven door is opened, the oven lights will automatically come on for the corresponding oven.
<b>KITCHEN TIMER</b> <b>(on some models)</b>	<b>Timer</b>	<p>The Kitchen Timer can be set in hours, minutes, or seconds up to 23 hours, 59 minutes, and 59 seconds.</p> <p>The Kitchen Timer does not start or stop the oven(s).</p>
<b>OVEN CANCEL</b> <b>UPPER CANCEL</b> <b>LOWER CANCEL</b> <b>(on some models)</b>	<b>Oven function</b>	The Lower Cancel, Upper Cancel, and Cancel stop their respective oven functions except for the Clock, Kitchen Timer, and Button Lock. The oven cooling fan(s) may continue to operate even after an oven function has been canceled or completed, depending on the oven temperature.
<b>START</b> <b>(on some models)</b>	<b>Mode Start</b>	Start begins some oven functions. If Start is not touched within 2 minutes after touching a keypad, the function is canceled, and the time of day is displayed.

KEYPAD	FEATURE	INSTRUCTIONS
<b>CLEAN SELF CLEAN</b> (on some models)	<b>Self-clean cycle</b>	See the “Self-Clean Cycle” section.
<b>TOOLS</b> (on some models)	<b>Oven use function</b>	The Tools keypad enables you to personalize the oven operation to suit your needs. See the “Tools” section.
<b>UPPER OVEN LOWER OVEN</b> (on some models)	<b>Oven selection</b>	The Upper and Lower Oven keypads enable you to select which oven you want to use.

## Touch Panel

The touch panel houses the control menu and function controls. The touch pads are very sensitive and require only a light touch to activate.

For more information about the individual controls, see their respective sections in this manual.

### Welcome Guide

This appears on your display the first time the oven is powered up. The Welcome Guide allows you to set up your new oven. After every selection, a tone will sound.

1. Select your language.
2. Select the clock by scrolling to the correct time in the hours and minutes column. You can then select AM/PM or 24-hour clock (military time).
3. Choose to have daylight savings time Auto Sync (turn on), or Do Not Adjust (turn off).
4. Enter current date (MM/DD/YYYY) by scrolling to the column to set the Month, Day, and Year. Touch SAVE.
5. Select the units of temperature. You can choose Fahrenheit or Celsius. Touch SAVE.
6. Select the Clock Theme by scrolling to the desired setting. Touch SAVE.

**NOTE:** This is the background for the center touch display.

## Display

The display is for both the menu and oven function controls. The touchpanel allows you to scroll through the oven menus. The display is very sensitive and requires only a light touch to activate and control.

When an oven is in use, the display will show the clock, mode, oven temperature, kitchen timer, and oven timer, if set. If the oven timer is not set, you can set it from this screen.

After approximately 2 minutes of inactivity, the display will go into sleep mode and the display will dim. When the oven is in operation, the display will remain bright.

During use, the display will show menus and the appropriate selections for the options being chosen.

## Display Navigation

If the oven is off, touch the Power keypad to activate the menu. From the home screen, all automatic cooking programs can be activated, all manual cooking programs can be set, options can be adjusted, and instructions, preparation, and tips can be accessed.

## Menu Demonstrations

### **! WARNING**

#### Food Poisoning Hazard

**Do not let food sit in oven more than one hour before or after cooking.**

**Doing so can result in food poisoning or sickness.**

In double oven models, touch the corresponding oven keypad to show the cooking modes and temperatures for the desired oven.

**NOTE:** A line will appear above the corresponding oven.

In single oven models, the display will show cooking modes and temperatures when the oven is turned on.

### Bake Demonstration

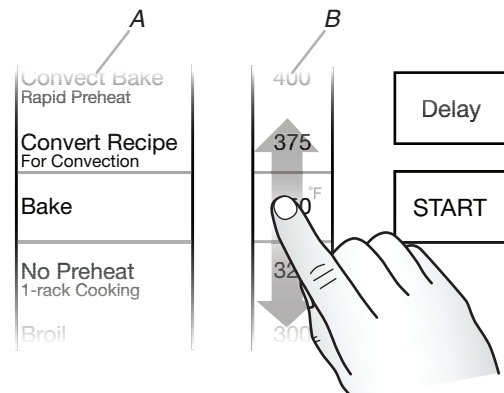

A. Modes column  
B. Temperature column

1. Confirm the Bake mode is selected.
2. In the temperature column, scroll to the desired temperature. The temperature must be between 170°F and 550°F (77°C and 288°C).
3. Touch START to begin preheating.

## Drop-down Message Demonstration

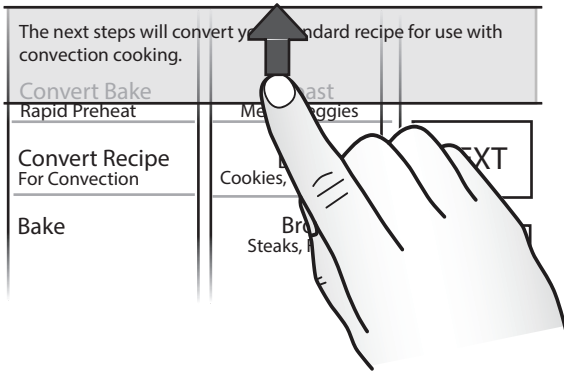

There are some menus that prompt a drop-down message to appear. Once the message is read, you can dismiss the menu by touching the directional arrow and swiping up.

## Cook Time Demonstration (Optional)

**NOTE:** In some cooking modes the user can set the cooking time while other modes have fixed times.

To set a cooking time, follow these instructions.

1. To set a cook time, touch **OVEN TIMER** once the cycle begins. Use the time columns or number keypads to enter the cooking length.
  2. Touch **START** to begin the timer.
- NOTE:** The Oven Timer is only visible once a cooking cycle has been activated.

**OR**

Select oven action when the timer expires. The default action is Hold Temp.

To change the default oven end of cycle action, touch **HOLD TEMP**, then select the desired oven action. Touch **SET** when completed or touch **BACK** to return to the oven timer screen.

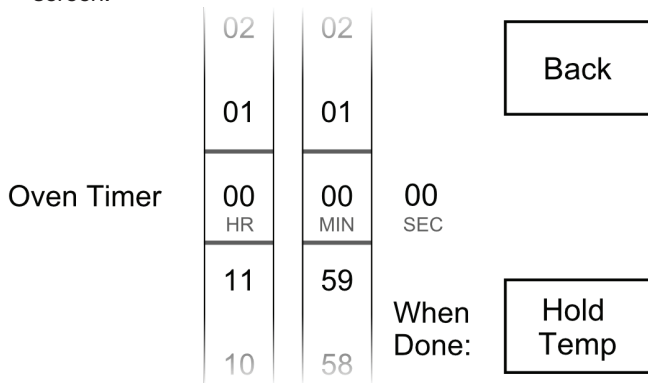

Keep Warm™ setting will reduce the oven temperature to 170°F (77°C) after the cook time ends. Hold Temp will keep the set oven temperature after the cook time ends. Oven Off will turn the oven off when the cook time ends.

## Delay Start Demonstration (Optional)

1. To set a delayed start and end time, touch **DELAY**.

**NOTE:** The cooking start time always begins on the nearest quarter hour (0:00, 0:15, 0:30 and 0:45). The cooking time includes oven preheating time. Adjust the start and end times accordingly.

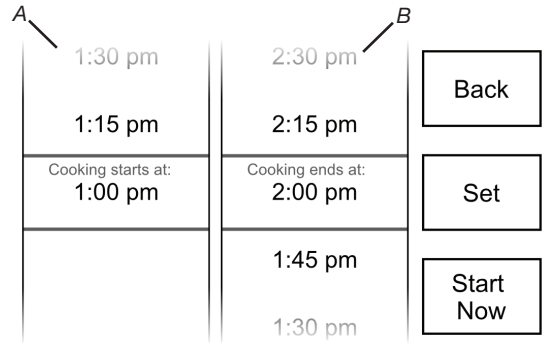

A. Start time column  
B. End time column

2. Touch or scroll to the desired cooking start time in the Start Time column on the left-hand side. The oven cannot be delayed more than 11 hours and 45 minutes.
  3. Touch or scroll to the desired cooking end time in the End Time column on the right-hand side. The cook time cannot be longer than 12 hours.
  4. Touch **BACK** to return to the Cooking Mode menu or touch **SET** when done. The oven will start preheating when the Start Time is reached. Once the end time is reached, the oven will go in to Keep Warm mode by default.
  5. Touch **START NOW** to start the oven from the Delay screen.
- NOTE:** Do not use Delay Start for items that require a preheated oven, such as cakes, cookies, and breads. If food is in the oven during preheat, it may become overcooked.
6. To change a cooking mode or temperature while the oven is preheating or in a Delay Start, touch the cooking mode key, make the new selection, and then touch **SET**.
  7. Touch **OVEN CANCEL**, **UPPER CANCEL**, or **LOWER CANCEL** to turn off the desired oven.

## Cooking Modes

The previous steps can be used for the following cooking modes:

MODE	TEMP. RANGE	DEFAULT TEMP.
<b>Convect Frozen Pizza</b>	300°F–500°F (149°C–260°C)	375°F (191°C)
<b>Convect Pastry</b>	170°F–550°F (77°C–288°C)	325°F (163°C)
<b>Convect Slow Roast 12hrs</b>	190°F–225°F (88°C–107°C)	200°F (93°C)
<b>Convect Slow Roast 8hrs</b>	200°F–250°F (93°C–121°C)	225°F (107°C)

MODE	TEMP. RANGE	DEFAULT TEMP.
<b>Convect Slow Roast 4hrs</b>	250°F–300°F (121°C–149°C)	275°F (135°C)
<b>Convect Roast</b>	170°F–550°F (77°C–288°C)	350°F (177°C)
<b>Convect Broil</b>	450°F–550°F (232°C–288°C)	550°F (288°C)
<b>Convect Bake</b>	170°F–550°F (77°C–288°C)	325°F (163°C)
<b>Convect Bake – Rapid Preheat</b>	170°F–550°F (77°C–288°C)	325°F (163°C)
<b>Bake</b>	170°F–550°F (77°C–288°C)	350°F (177°C)
<b>Broil</b>	450°F–550°F (232°C–288°C)	550°F (288°C)
<b>Keep Warm</b>	150°F–200°F (66°C–93°C)	170°F (77°C)
<b>Rapid Proof</b>	110°F (43°C)	110°F (43°C)
<b>Proof</b>	100°F (38°C)	100°F (38°C)
<b>Convert Recipe For Convection</b>	-	-
<b>Probe Cook</b>	-	-
<b>My Creations</b>	-	-

## Kitchen Timer

The Kitchen Timer can be set in hours, minutes, and seconds.

**NOTE:** The Kitchen Timer does not start or stop the oven.

## Tones/Sounds

Tones are audible signals, indicating the following:

- Valid keypad touch.
- Function has been entered.
- Preheat cycle has been completed.
- Invalid keypad touch.
- End of a cooking cycle.
- When timer reaches zero.
  - Includes using the Kitchen Timer for functions other than cooking.
- First oven element activation in a cooking mode.

## Tools

Tools allows you access to functions and customization options within the Electronic Oven Control. These tools allow you to set the clock, change the oven temperature between Fahrenheit and Celsius, turn the audible signals and prompts on and off, and adjust the oven calibration, change the language, and more. The Sabbath Mode is also set using Tools.

MODE	AVAILABLE SELECTIONS
<b>Sabbath</b>	■ Sets Sabbath Mode
<b>Demo Mode</b>	■ On ■ Off (Default)
<b>Temp Units</b>	■ Celsius ■ Fahrenheit (Default)
<b>Language</b>	■ Français ■ English (Default)
<b>Display On/Off</b>	■ Display Off ■ Display Dimmed (Default)
<b>Clock On/Off</b>	■ Clock Off ■ Clock On (Default)
<b>Brightness</b>	■ Max ■ High ■ Med (Default) ■ Low ■ Dim
<b>Sound</b>	■ Key Press ■ Timer & Alert (Default) ■ Power On & Off
<b>Clock Theme</b>	■ Textures ■ Celebration ■ Culinary ■ Clock Only ■ Animation (Default) ■ Spring ■ Summer ■ Fall ■ Winter
<b>Time &amp; Date</b>	■ Daylight Saving ■ Clock Style ■ Set Clock (Default) ■ Set Date
<b>Self Clean</b>	■ Starts the Self Clean Cycle
<b>Button Lock</b>	■ Press Lock to lock controls.
<b>Number Entry</b>	■ Number keypad ■ Scroll (Default)
<b>Probe</b>	■ Use for Probe Cooking Mode
<b>Temp Calib.</b>	■ +35°F to -35°F ■ +20°C to -20°C
<b>Touch Calib.</b>	■ Use to calibrate touch screen
<b>Service Info.</b>	■ Model Number and Serial Number
<b>Legal Info.</b>	■ License Information
<b>Restore Defaults</b>	■ Restores Factory Defaults

## Button Lock

The Button Lock shuts down the control panel keypads to avoid unintended use of the oven(s). The Button Lock will remain set after a power failure if it was set before the power failure occurs. When the control is locked, only the Power keypad will function.

The Button Lock is preset unlocked but can be locked.

### To Activate the Button Lock:

1. From the Tools menu, touch BUTTON LOCK.
2. Touch LOCK to activate the Button Lock mode.

**NOTE:** The touch screen will return to idle mode and a control locked message will be displayed.

### To Deactivate the Button Lock:

1. Touch the Power keypad, and then follow the on-screen directions.

**NOTE:** The oven will generate a random sequence of shapes that must be touched in the order prompted on the screen.

## Oven Temperature Control

**IMPORTANT:** Do not use a thermometer to measure the oven temperature. Elements will cycle on and off as needed to maintain a consistent temperature but may run slightly hot or cool at any point in time due to this cycling. Opening the oven door will affect cycling of the elements and impact the temperature.

The oven provides accurate temperatures and has been thoroughly tested at the factory. However, it may cook faster or slower than your previous oven, causing baking or browning differences. If necessary, the temperature calibration can be adjusted in either Fahrenheit or Celsius.

On double ovens, the upper oven and the lower oven can each be calibrated independently.

A minus sign means the oven will be cooler by the displayed amount. The absence of a minus sign means the oven will be warmer by the displayed amount. Use the following chart as a guide.

**NOTE:** The oven display will continue to show the original set temperature and will not reflect the calibration offset. For example, if set to 350°F (177°C) and calibrated to -20, the display will continue to show 350°F (177°C).

ADJUSTMENT °F (AUTOMATIC °C CHANGE)	COOKS FOOD
10°F (6°C)	a little more
20°F (12°C)	moderately more
30°F (18°C)	much more
0°F (0°C)	default setting
-10°F (-6°C)	a little less
-20°F (-12°C)	moderately less
-30°F (-18°C)	much less

## Sabbath Mode

The Sabbath Mode sets the oven(s) to remain on in a bake setting until turned off. A timed Sabbath Mode can also be set to keep the oven on for only part of the Sabbath.

When the Sabbath Mode is set, the allowed keypads are the Power keypad and the Cancel keypads.

When the oven door is opened or closed, the oven light will not turn on or off, and the heating elements will not turn on or off immediately.

If a power failure less than 1 second occurs when the Sabbath Mode is set, the oven(s) will remain in Sabbath Mode and continue cooking.

For a power failure that lasts greater than a few seconds, the oven(s) will return to an idle state and Sabbath mode will no longer be active. For double ovens, the upper and lower oven temperatures and cook timers can be set independently. If a cook timer is set, the countdown will not appear. The timer will appear frozen at the set time.

### To Activate:

1. Touch the Power keypad, and then touch TOOLS.
2. From the Mode menu, select "Sabbath" and touch NEXT.
3. Touch ON, and then touch SETUP.  
**NOTE:** The programmed status of the oven(s) will be displayed.
4. Touch CHANGE.
5. For single ovens, go to Step 6. For double ovens, select the desired oven, and then touch NEXT.
6. Select the desired oven temperature and touch NEXT.
7. (Optional) Set Bake Time (00:00) and touch SET.

**OR**

Touch SKIP TIMER.

8. For single ovens, touch START. For double ovens, touch START to begin Sabbath Mode, or touch CHANGE to edit the current programming or to program the other oven.

### To Deactivate:

Sabbath Mode can be deactivated on all cavities, once activated, by touching the Power keypad.

For single ovens, Sabbath Mode can also be deactivated by touching Cancel.

For double ovens, if both ovens are running, touching Cancel for one oven will turn off Sabbath Mode for both ovens and will turn off the selected oven. The other oven will return to a regular Bake mode.

## Delayed Sabbath Bake:

### **⚠ WARNING**

#### **Food Poisoning Hazard**

**Do not let food sit in oven more than one hour before or after cooking.**

**Doing so can result in food poisoning or sickness.**

For double ovens, the upper and lower oven temperatures and cook timers can be set independently.

If a cook timer is set, the countdown will not appear. The timer will appear frozen at the set time.

#### **To Activate:**

1. Touch the Power keypad, and then touch TOOLS.
2. From the Mode menu, select SABBATH and touch NEXT.
3. Touch ON, and then touch SETUP.  
**NOTE:** The programmed status of the oven(s) will be displayed.
4. Touch CHANGE.
5. For single ovens, go to Step 6. For double ovens, select the desired oven, and then touch NEXT.
6. Select the desired oven temperature, and then touch NEXT.

7. (Optional) Set Bake Time (00:00) and touch SET.

**OR**

Touch SKIP TIMER.

8. Touch DELAY and set the "Cooking Starts at" time.

**NOTE:** If a bake time is set in the previous steps, the "Cooking ends at" time will be calculated based on the bake time. If the timer is not set, the Sabbath Mode will continue until canceled.

9. Touch SET.

10. Review the settings and touch START to begin the baking cycle.

**NOTE:** Once the timer ends, opening and closing the oven door will deactivate the Sabbath Mode.

#### **Change Temperature**

The oven temperatures can be changed while running Sabbath Mode by touching  $-25^{\circ}\text{F}$  ( $-5^{\circ}\text{C}$ ) or  $+25^{\circ}\text{F}$  ( $+5^{\circ}\text{C}$ ). Touching these buttons will not result in any changes to the screen and no sound will play.

For example, touching  $+25^{\circ}\text{F}$  ( $+5^{\circ}\text{C}$ ) button three times will result in an oven cavity temperature increase of  $+75^{\circ}\text{F}$  ( $+15^{\circ}\text{C}$ ); however, the initial oven cavity set temperature will remain on the screen.

**NOTE:** On double oven models, the oven cavity temperature may be set individually.

## Oven Use

Odors and smoke are normal when the oven is used the first few times or when it is heavily soiled.

During oven use, the heating elements will not remain on but will cycle on and off throughout oven operation.

**IMPORTANT:** The health of some birds is extremely sensitive to the fumes given off. Exposure to the fumes may result in death to certain birds. Always move birds to another closed and well-ventilated room.

If the oven door is opened during a cooking mode and left open for approximately 60 seconds, the cooling fan will switch to a higher speed. You may experience higher noise during this time. When the oven door is closed, the fan will switch back to its lower speed after approximately 60 seconds.

### **Aluminum Foil**

**IMPORTANT:** To avoid permanent damage to the oven bottom finish, do not line the oven bottom with any type of foil or liner.

- For best cooking results, do not cover entire rack with foil because air must be able to move freely.
- To catch spills, place foil on rack below dish. Make sure foil is at least  $1/2$ " (13 mm) larger than the dish and that it is turned up at the edges.

## Position Racks and Bakeware

**IMPORTANT:** To avoid permanent damage to the porcelain finish, do not place food or bakeware directly on the oven door or bottom.

### Racks

- Position racks before turning on the oven.
- Do not position racks with bakeware on them.
- Make sure racks are level.

To move a rack, pull it out to the stop position, raise the front edge, and lift out. Use the following illustration and charts as guides.

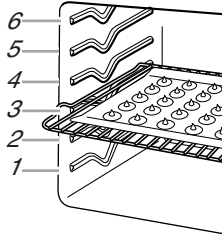

### Rack And Bakeware Positions

#### Rack Positions – Upper and Lower Oven

**NOTE:** Unless indicated with a “ro” (roll-out rack), all suggested rack positions are for flat racks.

#### Broiling

FOOD	RACK POSITION
Most broiling	6

For hamburger patties to have a well-seared exterior and a rare interior, use a flat rack in position 6. Side one should cook for approximately 3 minutes. Side two should cook for approximately 3 to 4 minutes. Expect a moderate degree of smoke when broiling.

#### Traditional Cooking

FOOD	RACK POSITION
Large roasts, turkeys, angel food cakes, bundt cakes, quick breads, pies	1 or 2
Yeast breads, casseroles, meat, poultry	2
Cookies, biscuits, muffins, cakes	2 or 3 when single-rack baking; 2 and 5 when multi-rack baking

#### Convection Cooking

OVEN SETTING	NUMBER OF RACKS USED	RACK POSITION(S)
Rapid Preheat Bake	1	3
Rapid Preheat Convection Bake	1	3
Convection Bake	1	1, 2, or 3
Convection Bake	2	2, and 5
Convection Bake	3	1, 3, and 5
Convection Roast	1	1, or 2
Convection Broil	1	4, 5, or 6

### Baking Cakes on Two Racks

For best results when baking cakes on two racks, use the Bake function and flat racks in positions 2 and 5. Place the cakes on the racks as shown. Keep at least 2" (5 cm) of space between the front of the racks and the front of the cakes.

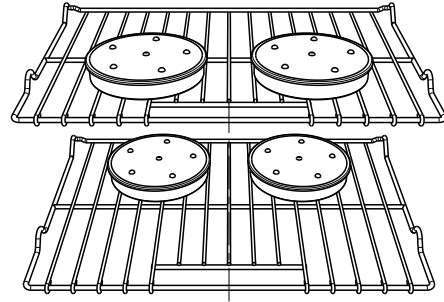

### Baking Cookies on Two Racks

For best results when baking cookies on two racks, use the Convection Bake function and place flat racks in positions 2 and 5.

#### Bakeware

To cook food evenly, hot air must be able to circulate. For best results, allow 2" (5 cm) of space around bakeware and oven walls. Use the following chart as a guide.

NUMBER OF PAN(S)	POSITION ON RACK
1	Center of rack.
2	Side by side or slightly staggered.
3 or 4	See the rack position graphics in this section for pan placement recommendations.

## Roll-Out Extension Rack

The roll-out extension rack allows easy access to position food in the oven, and remove food from the oven. It can be used in rack positions 1 through 6.

#### Open Position

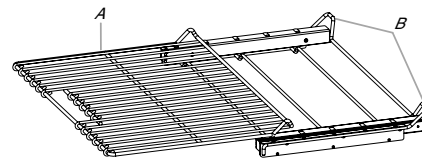

A. Roll-out extension rack  
B. Sliding shelf

#### Closed and Engaged Position

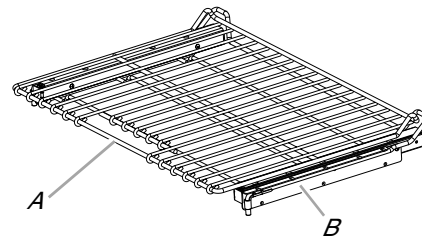

A. Roll-out extension rack  
B. Sliding shelf

### To Remove Roll-Out Extension Rack:

1. Slide the rack in completely so that it is closed and engaged with the sliding shelf.
2. Using two hands, lift up on the front edge of the rack and push the sliding shelf to the back wall of the oven so that the front edge of the sliding shelf sits on the rack guides. The front edge of the rack and the sliding shelf should be higher than the back edge.

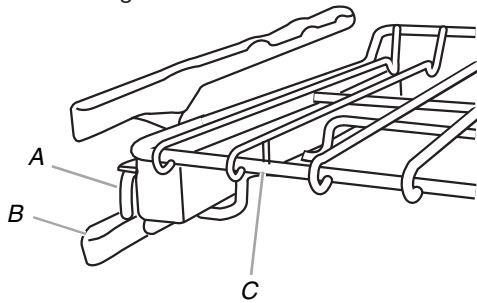

A. Sliding shelf  
B. Rack guide  
C. Roll-out extension rack

3. Pull the rack and the sliding shelf out.

### To Replace Roll-Out Extension Rack:

1. Using two hands, grasp the front of the closed rack and the sliding shelf. Place the closed rack and the sliding shelf on the rack guide.
2. Using two hands, lift up on the front edge of the rack and the sliding shelf together.
3. Slowly push the rack and the sliding shelf to the back of the oven until the back edge of the rack pulls over the end of the rack guide.

To avoid damage to the sliding shelves, do not place more than 25 lbs (11.4 kg) on the rack.

Do not clean the roll-out extension rack in a dishwasher. It may remove the rack's lubricant and affect its ability to slide. See the "General Cleaning" section for more information.

## Bakeware

The bakeware material affects cooking results. Follow manufacturer's recommendations and use the bakeware size recommended in the recipe. Use the following chart as a guide.

BAKEWARE/ RESULTS	RECOMMENDATIONS
<b>Light-colored aluminum</b> <ul style="list-style-type: none"> <li>■ Light golden crusts</li> <li>■ Even browning</li> </ul>	<ul style="list-style-type: none"> <li>■ Use temperature and time recommended in recipe.</li> </ul>
<b>Dark aluminum and other bakeware with dark, dull and/or nonstick finish</b> <ul style="list-style-type: none"> <li>■ Brown, crisp crusts</li> </ul>	<ul style="list-style-type: none"> <li>■ May need to reduce baking temperatures slightly.</li> <li>■ Use suggested baking time.</li> <li>■ For pies, breads, and casseroles, use temperature recommended in recipe.</li> <li>■ Place rack in center of oven.</li> </ul>
<b>Insulated cookie sheets or baking pans</b> <ul style="list-style-type: none"> <li>■ Little or no bottom browning</li> </ul>	<ul style="list-style-type: none"> <li>■ Follow rack recommendations in the "Position Racks and Bakeware" section.</li> <li>■ May need to increase baking time.</li> </ul>
<b>Stainless steel</b> <ul style="list-style-type: none"> <li>■ Light, golden crusts</li> <li>■ Uneven browning</li> </ul>	<ul style="list-style-type: none"> <li>■ May need to increase baking time.</li> </ul>
<b>Stoneware/Baking stone</b> <ul style="list-style-type: none"> <li>■ Crisp crusts</li> </ul>	<ul style="list-style-type: none"> <li>■ Follow manufacturer's instructions.</li> </ul>
<b>Ovenproof glassware or ceramic</b> <ul style="list-style-type: none"> <li>■ Brown, crisp crusts</li> </ul>	<ul style="list-style-type: none"> <li>■ May need to reduce baking temperatures slightly.</li> </ul>

## Oven Vents

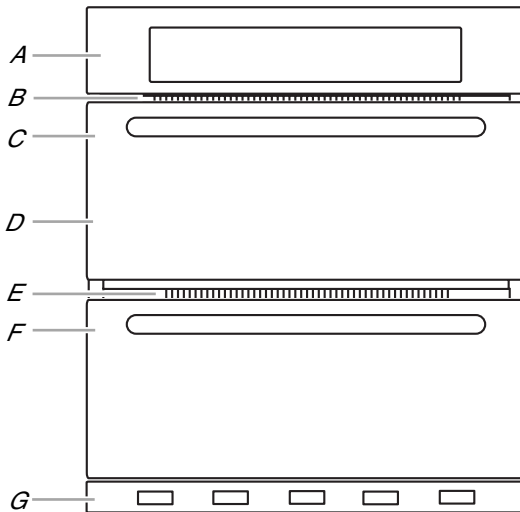

<i>Single and Double Oven</i>	<i>Double Oven</i>
A. Control panel	D. Upper oven
B. Oven vent	E. Oven vent
C. Single oven or upper double oven	F. Lower oven
G. Bottom vent	G. Bottom vent

The oven vents should not be blocked or covered since they allow the inlet of fresh air into the cooling system and allows the venting of heated air. Blocking or covering vents will cause poor air circulation, affecting cooking, cleaning, and cooling results.

## Preheating and Oven Temperature

### Preheating

When beginning a Bake or Convection Bake cycle, the oven begins preheating after Start is pressed. The oven will take approximately 12 to 17 minutes to reach 350°F (177°C) with all of the oven racks provided with your oven inside the oven cavity. Higher temperatures will take longer to preheat. The preheat cycle rapidly increases the oven temperature. The actual oven temperature will go above your set temperature to offset the heat lost when your oven door is opened to insert food. This ensures that when you place your food in the oven, the oven will begin at the proper temperature. Insert your food when the preheat tone sounds. Do not open the door during preheat until the tone sounds.

**NOTE:** If the cook timer is set and the oven door is opened during preheating, the timer will automatically start.

### Oven Temperature

While in use, the oven elements will cycle on and off as needed to maintain a consistent temperature. They may run slightly hot or cool at any point in time due to this cycling. Opening the oven door while in use will release the hot air and cool the oven, which could impact the cooking time and performance. It is recommended to use the oven light to monitor cooking progress.

## Baking and Roasting

**IMPORTANT:** The convection fan and convection element may operate during the Bake function to enhance performance and heat distribution.

The oven will take approximately 12 to 17 minutes to reach 350°F (177°C) with all oven racks inside the oven cavity. The preheat cycle rapidly increases the temperature inside the oven cavity. Higher temperatures will take longer to preheat. Factors that impact preheat times include room temperature, oven temperature, and the number of racks. Unused oven racks can be removed prior to preheating your oven to help reduce preheat time. The actual oven temperature will go above the set temperature to offset the heat lost when the oven door is opened to insert food. This ensures that the oven will begin at the proper temperature when you place food in the oven. Insert food when the preheat tone sounds. Do not open the door during preheat until the tone sounds.

During baking or roasting, the bake and broil elements will cycle on and off in intervals to maintain the oven temperature.

Depending on the model, if the oven door is opened during baking or roasting, the heating elements (bake and broil) will turn off approximately 30 seconds after the door is opened. They will turn on again approximately 30 seconds after the door is closed.

## Broiling

Broiling uses direct radiant heat to cook food.

The element cycles on and off in intervals to maintain the oven temperature.

**NOTE:** No preheating is required for the Broiling function.

**IMPORTANT:** Close the door to ensure proper broiling temperature.

If the oven door is opened during broiling, the broil element will turn off in approximately 30 seconds. When the oven door is closed, the element will come back on approximately 30 seconds later.

- For best results, use a broiler pan and grid. It is designed to drain juices and help avoid spatter and smoke.
- For proper draining, do not cover the grid with foil. The bottom of the broiler pan may be lined with aluminum foil for easier cleaning.
- Trim excess fat to reduce spattering. Slit the remaining fat on the edges to avoid curling.
- Pull out oven rack to stop position before turning or removing food. Use tongs to turn food to avoid the loss of juices. Very thin cuts of fish, poultry, or meat may not need to be turned.
- After broiling, remove the pan from the oven when removing the food. Drippings will bake on the pan if left in the heated oven, making cleaning more difficult.

## Convection

---

In a convection oven, the fan-circulated hot air distributes heat more evenly. This movement of hot air helps maintain a consistent temperature throughout the oven, cooking foods more evenly, while sealing in moisture.

Most foods, using convection baking mode, can be cooked by lowering cooking temperatures 25°F (14°C). The cooking time can be shortened significantly when using Convection Roast, especially for large turkeys and roasts.

- It is important not to cover foods with lids or aluminum foil so that surface areas remain exposed to the circulating air, allowing browning and crisping.
- Keep heat loss to a minimum by opening the oven door only when necessary. It is recommended to use the oven light to monitor progress.
- Choose cookie sheets without sides and roasting pans with lower sides to allow air to move freely around the food.
- Test baked goods for doneness a few minutes before the minimum cooking time using a method such as a toothpick.
- Use a meat thermometer or the temperature probe to determine the doneness of meats and poultry. Check the temperature of pork and poultry in two or three places.

## Convection Bake

---

The convection element is hidden in the rear panel of the oven cavity and, assisted by the convection fan, provides balanced, efficient heating.

Convection baking can be used for baking delicate cakes and pastries, as well as foods on multiple racks. It is helpful to stagger items on the racks to allow a more even flow of heat. If the oven is full, extra cooking time may be needed.

When cooking an oven meal with several different types of foods, be sure to select recipes that require similar temperatures. Cookware should sit in the oven with at least 2" (5 cm) of space between the cookware and the sides of the oven.

During convection baking preheat, the convection, bake, and broil elements all heat the oven cavity. After preheat, these elements will cycle on and off in intervals to maintain oven temperature, while the fan circulates the hot air.

If the oven door is opened during convection baking, the fan turns off immediately and turns on as soon as the door is closed. Convection, bake, and broil elements will turn off approximately 30 seconds after the door is opened. They will turn on again approximately 30 seconds after the door is closed.

**NOTE:** It is normal for the convection fan to run during non-convection cycles as well as during preheat.

- Reduce recipe temperature 25°F (14°C). The cook time may need to be reduced also.

### To Convection Bake:

Before convection baking, position racks according to the "Positioning Racks and Bakeware" section.

## Convection Roast

---

Convection roasting can be used for roasting meats and poultry. During convection roasting, the bake, broil, and convection elements will cycle on and off in intervals to maintain oven temperature, while the fan circulates the hot air.

If the oven door is opened during convection roasting, the fan turns off immediately and turns on as soon as the door is closed. The bake, broil, and convection elements will turn off approximately 30 seconds after the door is opened. They will turn on again approximately 30 seconds after the door is closed.

**NOTE:** It is normal for the convection fan to run during non-convection cycles as well as during preheat.

### To Convection Roast:

Before convection roasting, position racks according to the "Positioning Racks and Bakeware" section. It is not necessary to wait for the oven to preheat before putting food in, unless recommended in the recipe.

## Convection Broil

---

During convection broiling, the broil element will cycle on and off in intervals to maintain oven temperature, while the fan circulates the hot air.

The temperature is preset at 550°F (288°C), but can be changed to a different temperature. Cooking times will vary depending on the rack position and temperature, and may need to be adjusted.

If the oven door is opened during convection broiling, the fan turns off immediately and turns on as soon as the door is closed. Broil elements will turn off approximately 30 seconds after the door is opened. They will turn on again approximately 30 seconds after the door is closed.

**NOTE:** It is normal for the convection fan to run during non-convection cycles as well as during preheat.

### To Convection Broil:

For ideal performance allow the oven to preheat for 5 minutes (no preheat tone will sound). Position food on the unheated grid on the broiler pan, and then place it in the center of the oven rack with the longest side parallel to the door.

## Proofing Bread

---

Proofing bread prepares dough for baking by activating the yeast. Proofing twice is recommended unless the recipe directs otherwise.

### To Proof:

For best performance, ensure your oven cavity temperature is below 120°F (49°C) before placing dough in oven cavity.

Before first proofing, place dough in a lightly greased bowl and cover loosely with plastic wrap coated with shortening or cooking spray. Place on a rack in rack position 2. See the "Positioning Racks and Bakeware" for diagram. Close door.

1. Touch PROOF. Display will show 100°F (38°C).
2. Touch START.

Let dough rise until nearly doubled in size. Check at 20 to 25 minutes. Proofing time may vary depending on dough type and quantity.

3. Touch CANCEL for the selected oven when finished proofing.

Before second proofing, shape dough, place in baking pan(s) and cover loosely. Follow the same placement and control steps above. Before baking, remove waxed paper or plastic wrap.

## Temperature Probe

The temperature probe accurately measures the internal temperature of meat, poultry, and casseroles with liquid and should be used in determining the doneness of meat and poultry. The temperature probe should only be used with Bake, Convection Bake, or Convection Roast.

Always unplug and remove the temperature probe from the oven when removing food.

### To Use:

Before using, insert the probe into the food item. For meats, the probe tip should be located in the center of the thickest part of the meat and not into the fat or touching a bone. Place food in oven and connect the temperature probe to the jack. Keep probe as far away from heat source as possible. Close oven door.

**NOTE:** The temperature probe must be inserted into the food item before the mode is selected.

1. Touch the Power keypad or select "Probe Cook" from the Cooking Mode menu.
2. Scroll to the desired cooking mode.
3. Scroll to the desired oven temperature.
4. Scroll to the desired food temperature.
5. Touch START.

OR

Touch DELAY to delay the baking cycle. Refer to the "Timed Cooking" section for setting delayed start and stop times.

## Timed Cooking

### WARNING

#### Food Poisoning Hazard

**Do not let food sit in oven more than one hour before or after cooking.**

**Doing so can result in food poisoning or sickness.**

Cook Time and Delay Start allow the oven(s) to be set to turn on at a certain time of day, cook for a set length of time, and/or shut off automatically. Delay Start should not be used for food such as breads and cakes because they may not bake properly.

### To Set an Oven Time:

The Oven Timer will turn the selected oven off when the set time has expired. The maximum length is 11:59:00.

1. Touch the desired cooking mode and scroll to the desired oven temperature, then touch START.
2. Touch OVEN TIMER next to the displayed cooking mode and temperature.

3. Scroll to the desired length of time for the Oven Timer.
4. Touch START.

OR

Touch WHEN DONE to select the behavior of the oven after the Oven Timer has completed. Choose between HOLD TEMP (default), KEEP WARM, and OVEN OFF. Touch SET.

When the OVEN TIMER has completed, the When Done behavior will begin and a message of "TIMER ENDED AT XX:XX" (the time of day) is displayed.

If enabled, end-of-cycle tones will sound and then tones will sound every minute.

5. Touch CANCEL for the selected oven, or open and close the oven door, to clear the display and/or stop reminder tones.

### To Set a Delay Start Time and Stop Time:

Before setting, make sure the clock is set to the correct time of day. For double ovens, be sure to select the desired oven before proceeding.

1. Touch the desired cooking mode and scroll to the desired oven temperature.

**NOTE:** Delay Start may be used with the Bread Proof function, but the temperature is not adjustable.

2. Touch DELAY.
3. Scroll to the desired "Cooking Starts at" time.  
**NOTE:** The start and end times are rounded to the nearest quarter hour (00:00, 00:15, 00:30 or 00:45)
4. Scroll to the desired "Cooking Ends at" time.
5. Touch SET.

OR

Touch START NOW to immediately begin the cooking timer.

The difference between the "Cooking Starts at" time and the "Cooking Ends at" time is used as the cooking timer.

When the start time is reached, the oven will automatically turn on. The minute time countdown will appear on the oven display.

When the Oven Timer has completed, the When Done behavior will begin and a message of "TIMER ENDED AT XX:XX" (the time of day) is displayed.

If enabled, end-of-cycle tones will sound, and then reminder tones will sound every minute.

6. Touch CANCEL for the selected oven to cancel the current cycle and return to the main menu.

If the oven door is opened and closed after the cycle ends, the display will be cleared and the reminded tones will stop, but the oven will continue to operate in the end of cycle behavior selected (Keep Warm is the default behavior).

## Self-Cleaning Cycle

### ⚠ WARNING



#### Burn Hazard

**Do not touch the oven during the Self-Cleaning cycle.**

**Keep children away from oven during Self-Cleaning cycle.**

**Failure to follow these instructions can result in burns.**

**IMPORTANT:** The health of some birds is extremely sensitive to the fumes given off during the Self-Cleaning cycle. Exposure to the fumes may result in death to certain birds. Always move birds to another closed and well-ventilated room.

Self-clean the oven before it becomes heavily soiled. Heavy soil results in longer cleaning and more smoke.

Keep the kitchen well-ventilated during the Self-Cleaning cycle to help get rid of heat, odors, and smoke.

Do not block the oven vent(s) during the Self-Cleaning cycle. Air must be able to move freely. See the "Oven Vents" section.

Do not clean, rub, damage, or move the oven door gasket. The door gasket is essential for a good seal.

#### Prepare Oven:

- Remove the broiler pan, grid, cookware and bakeware, and on some models, the temperature probe from the oven.
- Remove oven racks to keep them shiny and easy to slide. See "General Cleaning" section for more information.
- Remove any foil from the oven because it may burn or melt, damaging the oven.
- Hand clean inside door edge and the 1½" (3.8 cm) area around the inside oven cavity frame, being certain not to move or bend the gasket. This area does not get hot enough during high temp self-cleaning to remove soil. Do not let water, cleaner, etc., enter slots on door frame. Use a damp cloth to clean this area.
- Wipe out any loose soil to reduce smoke and avoid damage. At high temperatures, foods react with porcelain. Staining, etching, pitting, or faint white spots can result. This is normal and will not affect cooking performance.

#### How the Cycle Works

**IMPORTANT:** The heating and cooling of porcelain on steel in the oven may result in discoloring, loss of gloss, hairline cracks, and popping sounds.

The Self-Cleaning cycle uses very high temperatures, burning soil to a powdery ash.

Suggested clean times are 3 hours for light soil, 4 hours for medium soil, and 5 hours for heavy soil.

Once the oven has completely cooled, remove ash with a damp cloth. To avoid breaking the glass, do not apply a cool damp cloth to the inner door glass before it has completely cooled.

The oven lights will not work during the Self-Cleaning cycle.

**NOTE:** The oven has a two-speed cooling fan motor. During self-clean, the fan(s) will operate at its highest speed to increase airflow to better exhaust the hotter air through the oven vent(s). An increase in noise may be noticeable during and after the self-clean cycle until the oven cools.

#### To Start Self-Cleaning Cycle:

Before Self-Cleaning, make sure the door is closed completely or it will not lock and the cycle will not begin.

1. For single ovens, touch SELF CLEAN. For double ovens, touch TOOLS, select SELF CLEAN, and then touch the desired oven to clean.
2. Select the desired time/soil level, and then touch NEXT.
3. Read the on-screen instructions, and then touch NEXT.
4. Follow the on-screen directions. The oven will prompt you to touch a series of keypads to confirm the self-clean cycle.

The oven will start locking the door and after a brief pause, the self clean timer and mode status will appear on the screen.

When the Self-Cleaning cycle has completed, the oven door will remain locked until the oven cools. For best cleaning performance, follow any on screen directions before returning the oven to regular service.

#### To Stop Self-Cleaning Anytime:

Touch CANCEL for the appropriate oven. If the oven temperature is too high, the door will remain locked. It will not unlock until the oven cools.

## General Cleaning

**IMPORTANT:** Before cleaning, make sure all controls are off and the oven is cool. Always follow label instructions on cleaning products. For additional information, you can visit the Frequently Asked Questions (FAQs) section of our website at [www.jennair.com](http://www.jennair.com). In Canada, reference the Customer Service section at [www.jennair.ca](http://www.jennair.ca).

Soap, water, and a soft cloth or sponge are suggested first unless otherwise noted.

#### STAINLESS STEEL (on some models)

To avoid damage to stainless steel surfaces, do not use soap-filled scouring pads, abrasive cleaners, Cooktop Cleaner, steel-wool pads, gritty washcloths or abrasive paper towels.

#### Cleaning Method:

Rub in direction of grain to avoid damaging.

- affresh® Stainless Steel Cleaner Part Number W10355016 (not included):

See the "Accessories" section for more information.

#### OVEN DOOR EXTERIOR

#### Cleaning Method:

- Glass cleaner and a soft cloth or sponge:  
Apply glass cleaner to soft cloth or sponge, not directly on panel.

- affresh® Kitchen and Appliance Cleaner Part Number W10355010 (not included):

See the "Accessories" section for more information.

---

## OVEN DOOR INTERIOR

### Cleaning Method:

■ Self-Cleaning cycle:

For optimal door cleaning result, wipe away any deposits with a damp sponge before running cycle.

---

## CONTROL PANEL

To avoid damage to the control panel, do not use abrasive cleaners, steel-wool pads, gritty washcloths, or abrasive paper towels.

### Cleaning Method:

■ Glass cleaner and soft cloth or sponge:

Apply glass cleaner to soft cloth or sponge, not directly on panel.

■ affresh® Kitchen and Appliance Cleaner Part Number W10355010 (not included):

See the “Accessories” section for more information.

---

## OVEN CAVITY

Do not use oven cleaners.

Food spills should be cleaned when oven cools. At high temperatures, foods react with porcelain and staining, etching, pitting, or faint white spots can result.

### Cleaning Method:

■ Self-Cleaning cycle:

See the “Self-Cleaning Cycle” first.

---

## OVEN RACKS

### Cleaning Method:

■ Steel-wool pad

---

## Oven Lights

The oven lights are 120-volt, 40-watt maximum halogen bulbs. They will come on when the oven door is opened. On double oven models, the lights will only come on for the oven that has the door open. The oven lights will not work during the Self-Cleaning cycle.

When the door is closed, touch the appropriate Oven Light keypad to turn on the oven light.

### To Replace:

Before replacing the bulb, make sure the oven is off and cool.

1. Disconnect power.
2. Remove glass light cover by grasping the front edge and pulling away from oven.

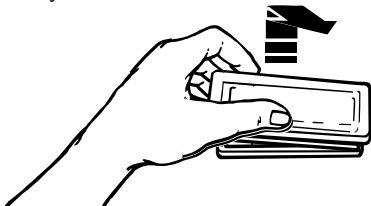

3. Remove bulb from socket.
4. Replace bulb, using tissue or wearing cotton gloves to handle bulb. To avoid damage to or decreasing the life of the new bulb, do not touch bulb with bare fingers.
5. Replace bulb cover by snapping back into wall.
6. Reconnect power.

**IMPORTANT:** Do not use bulbs rated higher than 40-watts.

---

## Oven Door

**IMPORTANT:** To avoid oven door glass breakage:

- Do not close the oven door if the racks are not fully inserted into the oven cavity or when bakeware extends past the front edge of an oven rack.
- Do not set objects on the glass surface of the oven door.
- Do not hit glass surfaces with bakeware or other objects.
- Do not wipe down glass surfaces until the oven has completely cooled.

For normal oven use, it is not suggested to remove the oven door. However, if removal is necessary, make sure the oven is off and cool. Then, follow these instructions. The oven door is heavy.

### To Remove:

1. Open oven door all the way.
2. Flip up the hinge latch on each side.

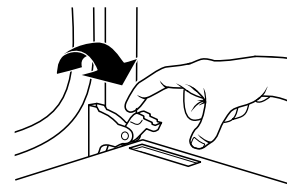

3. Close the oven door as far as it will shut.
4. Lift the oven door while holding both sides.

Continue to push the oven door closed and pull it away from the oven doorframe.

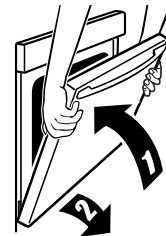

### To Replace:

1. Insert both hanger arms into the door.



2. Open the oven door.  
You should hear a “click” as the door is set into place.
3. Move the hinge levers back to the locked position.  
Check that the door is free to open and close. If it is not, repeat the removal and installation procedures.

# Troubleshooting

First try the solutions suggested here. If you need further assistance or more recommendations that may help you avoid a service call, refer to the warranty page in this manual and scan the code there with your mobile device, or visit [producthelp.jennair.com](http://producthelp.jennair.com). In Canada, visit <http://www.jennair.ca>.

Contact us by mail with any questions or concerns at the address below:

In the U.S.A.:

Jenn-Air Brand Home Appliances  
Customer eXperience Center  
553 Benson Road  
Benton Harbor, MI 49022-2692

In Canada:

Jenn-Air Brand Home Appliances  
Customer eXperience Centre  
200 – 6750 Century Ave.  
Mississauga, Ontario L5N 0B7

Please include a daytime phone number in your correspondence.

PROBLEM	POSSIBLE CAUSES AND/OR SOLUTIONS
Nothing will operate	<b>Has a household fuse blown, or has a circuit breaker tripped?</b> Replace the fuse or reset the circuit breaker. If the problem continues, call an electrician. <b>Is the appliance wired properly?</b> See Installation Instructions.
Oven will not operate	<b>Has a Delay Start been set?</b> See the “Timed Cooking” section. <b>Is the Button Lock set?</b> See the “Button Lock” section. <b>Is the Sabbath Mode set?</b> See the “Sabbath Mode” section. <b>On double oven models, is one oven self-cleaning?</b> When one oven is self-cleaning, the other oven cannot be set or turned on.
Oven temperature too high or too low	<b>Does the oven temperature calibration need adjustment?</b> See the “Oven Temperature Control” section.
Warm air coming from oven vent	Warm air coming from the oven vent is normal. During a self-clean cycle, the air stream is increased. The cooling fan may operate both during an oven’s cycle and after the cycle has ended, causing warm air to exit from the oven vent.
Display shows messages	<b>Is the display showing a letter followed by a number?</b> Power off, wait 10 seconds, and then power on. If a letter followed by a number reappears, call for service.
Fan runs during Bake function	It is normal for the convection fan and element to operate during Bake mode to enhance performance and heat distribution.
Long preheat times	Not all cycles require preheating. See the cycle instructions for preheat recommendations. Most cycles preheat to 350°F (177°C) in 12 to 17 minutes. Higher temperatures will take more time. Removing unused oven racks prior to preheating can help reduce preheat time.
Self-Cleaning cycle will not operate	<b>Is the oven door open?</b> Close the oven door all the way. <b>Has the function been entered?</b> See the “Self-Cleaning Cycle” section. <b>Has a Delay Start Self-Clean cycle been set?</b> See the “Self-Cleaning Cycle” section. <b>On double oven models, is one oven self-cleaning?</b> When one oven is self-cleaning, the other oven cannot be set to self-clean.

## Troubleshooting

PROBLEM	POSSIBLE CAUSES AND/OR SOLUTIONS
<b>Oven cooking results not what expected</b>	<p><b>Is the proper temperature set?</b> Double-check the recipe in a reliable cookbook.</p> <p><b>Is the proper oven temperature calibration set?</b> See the “Oven Temperature Control” section.</p> <p><b>Was the oven preheated?</b> See the “Baking and Roasting” section.</p> <p><b>Is the proper bakeware being used?</b> See the “Bakeware” section.</p> <p><b>Are the racks positioned properly?</b> See the “Positioning Racks and Bakeware” section.</p> <p><b>Is there proper air circulation around bakeware?</b> See the “Positioning Racks and Bakeware” section.</p> <p><b>Is the batter evenly distributed in the pan?</b> Check that batter is level in the pan.</p> <p><b>Is the proper length of time being used?</b> Adjust cooking time.</p> <p><b>Has the oven door been opened while cooking?</b> Oven peeking releases oven heat and can result in longer cooking times.</p> <p><b>Are baked items too brown on the bottom?</b> Move rack to higher position in the oven.</p> <p><b>Are pie crust edges browning early?</b> Use aluminum foil to cover the edge of the crust and/or reduce baking temperature.</p>
<b>Uneven browning of baked items</b>	<p>See the “Positioning Racks and Bakeware” section.</p> <p>Center the baking pan(s) on the rack and allow a minimum of 2" (5 cm) of clearance around all sides of the pan(s).</p> <p>Allow a minimum of 2" (5 cm) of clearance between the oven door and the front edge of baking pans.</p>
<b>Fan gets louder during cooking mode with the door open</b>	<p>If the oven door is opened during a cooking mode and left open for approximately 60 seconds, the cooling fan will switch to a higher speed. You may experience higher noise during this time. When the oven door is closed, the fan will switch back to its lower speed after approximately 60 seconds.</p>

## Accessories

For accessories in the U.S.A., you can visit our website at [www.jennair.com](http://www.jennair.com) or call us at **1-800-JENNAIR (1-800-536-6247)**. In Canada, visit our website at [www.jennair.ca](http://www.jennair.ca) or call us at **1-800-JENNAIR (1-800-536-6247)**.

### Complete Cooktop Cleaner Kit

(ceramic glass models)  
(includes cleaner, protectant, protectant applicator, scraper, and cleaner pads)  
Order Part Number 31605

### Cooktop Protectant

(ceramic glass models)  
Order Part Number 31463A

### affresh® Stainless Steel Cleaning Wipes

(stainless steel models)  
Order Part Number W10355049

### affresh® Cooktop Cleaner

(ceramic glass models)  
Order Part Number W10355051

### Cooktop Cleaning Pads

(ceramic glass models)  
Order Part Number W10391473

### affresh® Stainless Steel Cleaner

(stainless steel models)  
Order Part Number W10355016

### affresh® Kitchen and Appliance Cleaner

Order Part Number W10355010

### AquaLift® Oven Cleaning Kit

Order Part Number W10423113RP

### Cooktop Scraper

(ceramic glass models)  
Order Part Number WA906B

### Granite Cleaner and Polish

Order Part Number W10275756

### Gas Grate and Drip Pan Cleaner

Order Part Number 31617A

### Gourmet Griddle

Order Part Number W10432539

### Heavy Duty Flat Oven Rack

Order Part Number W10554005

### Split Oven Rack

Order Part Number 4396927

### HD Max Capacity Oven Rack

Order Part Number W10554006

### 27" Sliding Flat Oven Rack

Order Part Number W10861837

### 30" Sliding Flat Oven Rack

Order Part Number W10860776

### Porcelain Broiler Pan and Grid

Order Part Number 4396923

### Premium Broiler Pan and Roasting Rack

Order Part Number W10123240

### Trim Assembly

5/8" (17 mm) White – Order Part Number W10675027

5/8" (17 mm) Black – Order Part Number W10675026

5/8" (17 mm) Stainless Steel – Order Part Number W10675028

1½" (2.9 cm) White – Order Part Number W10731885

1½" (2.9 cm) Black – Order Part Number W10731886

1½" (2.9 cm) Stainless Steel – Order Part Number W10731887

### Backsplash Assembly

White – Order Part Number W10655448

Black – Order Part Number W10655449

Stainless Steel – Order Part Number W10655450

### Grill Kit

Order Part Number W10432545

# JENN-AIR® MAJOR APPLIANCE LIMITED WARRANTY

ATTACH YOUR RECEIPT HERE. PROOF OF PURCHASE IS REQUIRED TO OBTAIN WARRANTY SERVICE.

Please have the following information available when you call the Customer eXperience Center:

- Name, address and telephone number
- Model number and serial number
- A clear, detailed description of the problem
- Proof of purchase including dealer or retailer name and address

## IF YOU NEED SERVICE:

1. Before contacting us to arrange service, please determine whether your product requires repair. Some questions can be addressed without service. Please take a few minutes to review the Troubleshooting or Problem Solver section of the Use and Care Guide, scan the QR code on the right to access additional resources, or visit <https://jennair.custhelp.com>.
2. All warranty service is provided exclusively by our authorized Jenn-Air Service Providers. In the U.S. and Canada, direct all requests for warranty service to:

**Jenn-Air Customer eXperience Center**  
**1-800-JENNAIR (1-800-536-6247)**



<https://jennair.custhelp.com>

If outside the 50 United States or Canada, contact your authorized Jenn-Air dealer to determine whether another warranty applies.

## TWO YEAR LIMITED WARRANTY

### WHAT IS COVERED

### WHAT IS NOT COVERED

For two years from the date of purchase, when this major appliance is installed, operated and maintained according to instructions attached to or furnished with the product, Jenn-Air brand of Whirlpool Corporation or Whirlpool Canada LP (hereafter "Jenn-Air") will pay for Factory Specified Replacement Parts and repair labor to correct defects in materials or workmanship that existed when this major appliance was purchased, or at its sole discretion replace the product. In the event of product replacement, your appliance will be warranted for the remaining term of the original unit's warranty period.

YOUR SOLE AND EXCLUSIVE REMEDY UNDER THIS LIMITED WARRANTY SHALL BE PRODUCT REPAIR AS PROVIDED HEREIN. Service must be provided by a Jenn-Air designated service company. This limited warranty is valid only in the United States or Canada and applies only when the major appliance is used in the country in which it was purchased. This limited warranty is effective from the date of original consumer purchase. Proof of original purchase date is required to obtain service under this limited warranty.

1. Commercial, non-residential, multiple-family use, or use inconsistent with published user, operator or installation instructions.
2. In-home instruction on how to use your product.
3. Service to correct improper product maintenance or installation, installation not in accordance with electrical or plumbing codes or correction of household electrical or plumbing (i.e. house wiring, fuses or water inlet hoses).
4. Consumable parts (i.e. light bulbs, batteries, air or water filters, preservation solutions, etc.).
5. Defects or damage caused by the use of non-genuine Jenn-Air parts or accessories.
6. Conversion of products from natural gas or L.P. gas.
7. Damage from accident, misuse, abuse, fire, floods, acts of God or use with products not approved by Jenn-Air.
8. Repairs to parts or systems to correct product damage or defects caused by unauthorized service, alteration or modification of the appliance.
9. Cosmetic damage including scratches, dents, chips, and other damage to the appliance finishes unless such damage results from defects in materials and workmanship and is reported to Jenn-Air within 30 days.
10. Discoloration, rust or oxidation of surfaces resulting from caustic or corrosive environments including but not limited to high salt concentrations, high moisture or humidity or exposure to chemicals.
11. Food or medicine loss due to product failure.
12. Pick-up or delivery. This product is intended for in-home repair.
13. Travel or transportation expenses for service in remote locations where an authorized Jenn-Air servicer is not available.
14. Removal or reinstallation of inaccessible appliances or built-in fixtures (i.e. trim, decorative panels, flooring, cabinetry, islands, countertops, drywall, etc.) that interfere with servicing, removal or replacement of the product.
15. Service or parts for appliances with original model/serial numbers removed, altered or not easily determined.

**The cost of repair or replacement under these excluded circumstances shall be borne by the customer.**

### DISCLAIMER OF IMPLIED WARRANTIES

IMPLIED WARRANTIES, INCLUDING ANY IMPLIED WARRANTY OF MERCHANTABILITY OR IMPLIED WARRANTY OF FITNESS FOR A PARTICULAR PURPOSE, ARE LIMITED TO ONE YEAR OR THE SHORTEST PERIOD ALLOWED BY LAW. Some states and provinces do not allow limitations on the duration of implied warranties of merchantability or fitness, so this limitation may not apply to you. This warranty gives you specific legal rights, and you also may have other rights that vary from state to state or province to province.

### DISCLAIMER OF REPRESENTATIONS OUTSIDE OF WARRANTY

Jenn-Air makes no representations about the quality, durability, or need for service or repair of this major appliance other than the representations contained in this warranty. If you want a longer or more comprehensive warranty than the limited warranty that comes with this major appliance, you should ask Jenn-Air or your retailer about buying an extended warranty.

### LIMITATION OF REMEDIES; EXCLUSION OF INCIDENTAL AND CONSEQUENTIAL DAMAGES

YOUR SOLE AND EXCLUSIVE REMEDY UNDER THIS LIMITED WARRANTY SHALL BE PRODUCT REPAIR AS PROVIDED HEREIN. JENN-AIR SHALL NOT BE LIABLE FOR INCIDENTAL OR CONSEQUENTIAL DAMAGES. Some states and provinces do not allow the exclusion or limitation of incidental or consequential damages, so these limitations and exclusions may not apply to you. This warranty gives you specific legal rights, and you also may have other rights that vary from state to state or province to province.

