

OWNER'S MANUAL

AIR CONDITIONER

Please read this manual carefully before operating your set and retain it for future reference.

TYPE : WALL MOUNTED



P/NO : MFL67502019

<http://www.lghvac.com>
www.lg.com

TIPS FOR SAVING ENERGY

Here are some tips that will help you minimize power consumption when you use your air conditioner.

- Do not cool excessively indoors. This may be harmful for your health and may consume more electricity.
- Block sunlight with blinds or curtains while you are operating the air conditioner.
- Keep doors or windows closed tightly while you are operating the air conditioner.
- Adjust the direction of the air flow vertically or horizontally to circulate indoor air.
- Speed up the fan to cool indoor air quickly.
- Open windows regularly for ventilation as the indoor air quality may deteriorate if the air conditioner is used for many hours.
- Clean the air filter once every 2 weeks. Dust and impurities collected in the air filter may block the air flow or weaken the cooling / dehumidifying functions.

For your records

Staple your receipt to this page in case you need it to prove the date of purchase or for warranty purposes. Write the model number and the serial number here:

Model number : _____

Serial number : _____

You can find them on a label on the side of each unit.

Dealer's name : _____

Date of purchase : _____

IMPORTANT SAFETY INSTRUCTIONS

READ ALL INSTRUCTIONS BEFORE USING THE APPLIANCE.

Always comply with the following precautions to avoid dangerous situations and to ensure peak performance of your product.

WARNING

It can result in serious injury or death when the directions are ignored.

CAUTION

It can result in minor injury or product damage when the directions are ignored.

WARNING

- Installation or repairs made by unqualified persons can result in hazards to you and others.
- Installation **MUST** conform with local building codes or, in the absence of local codes, with the National Electrical Code NFPA 70/ANSI C1-1003 or current edition and Canadian Electrical Code Part 1 CSA C.22.1.
- The information contained in the manual is intended for use by a qualified service technician familiar with safety procedures and equipped with the proper tools and test instruments.
- Failure to read and follow all instructions in this manual can result in equipment malfunction, property damage, personal injury and/or death.

Power

- Unplug the power plug immediately in the event of a blackout or thunderstorm. Failure to do so may result in fire or electric shock.
- Always use a power plug and socket with a ground terminal. Failure to do so may result in electric shock or product failure.
- Install a dedicated electric outlet and circuit breaker before you use the air conditioner. Failure to do so may result in electric shock or product failure.
- Do not connect the ground wire to a gas pipe, a lightning rod or a telephone ground wire. It may result in electric shock or product failure.
- Use a standard circuit breaker and fuse conforming with the rating of the air conditioner. Failure to do so may result in electric shock or product failure.
- Make sure to check that the power cable plug is not dirty, loose or broken and then only insert the plug completely. It may result in electric shock or product failure.
- Do not modify or extend the power cable. If the power cable or cord has scratches or skin peeled off or deteriorated then it must be replaced. It may result in fire or electric shock.
- Don't use a power cord, a plug or a loose socket which is damaged. It may result in fire or electric shock.
- Do not use a damaged power cord or plug. It may result in electric shock or product failure.
- Do not touch, operate or repair the air conditioner with wet hands. It may result in electric shock or product failure.
- Make sure that the power plug is not damaged when you move the air conditioner. Failure to do so may result in electric shock or product failure.

READ ALL INSTRUCTIONS BEFORE USING THE APPLIANCE.

- Do not place a heater or other heating appliances near the power cable. It may result in fire, electric shock, or product failure.
- Make sure that the power cord is not pulled or damaged while the air conditioner is operating. Failure to do so may result in fire, electric shock, or product failure.
- Do not place any objects on the power cord. It may result in electric shock or product failure.

Installation

- Do not install the air conditioner on an unstable surface or where there may be a danger of it falling. It may result in death, serious injury, or product failure.
- Contact an authorized service center when you install or relocate the air conditioner. Failure to do so may result in serious injury or product failure.
- Indoor/outdoor wiring connections must be secured tightly, and the cable should be routed properly so that there is no force pulling the cable from the connection terminals. Improper or loose connections can cause heat generation or fire.
- Install the panel and the cover of the control box safely. Failure to do so may result in explosion or fire.
- Do not install the air conditioner where flammable liquids or gases such as gasoline, propane, paint thinner, etc. are stored. It may result in explosion or fire.
- Make sure that the pipe and the power cable that connect the indoor unit and the outdoor unit are not pulled tight when you install the air conditioner. Failure to do so may result in electric shock or product failure.
- Do not mix air or gas in the system except for the specific refrigerant. If air enters the refrigerant system, it may result in an excessively high pressure that causes injury or damage to the equipment.

Use

- Be sure to use only those parts which are listed in the service parts list. Never attempt to modify the equipment. It may result in death, serious injury, or product failure.
- Do not pull the power cord when you remove the power plug. It may result in death or electric shock.
- Discard the batteries where there is no danger of fire. Failure to do so may result in explosion or fire.
- Contact a qualified HVAC technician when the air conditioner is submerged in water due to flooding. Failure to do so may result in death, explosion, or fire.
- Only use components that are approved by the manufacturer and do not repair or modify them. Failure to do so may result in electric shock or product failure.
- Only use the refrigerant specified on the air conditioner label. Failure to do so may result in explosion or fire.
- Do not allow water to run into the air conditioner. It may result in explosion or fire.
- Do not leave flammable substances such as gasoline, benzene and thinner near the air conditioner. It may result in explosion or fire.
- Do not use the air conditioner for an extended period of time in a small place without proper ventilation. It may result in explosion or fire.
- Do not touch the electrostatic filter after opening the front grille. It may result in electric shock or product failure.
- For inner cleaning, contact a qualified HVAC technician or a dealer.
Using harsh detergents may cause corrosion or damage to the unit and may lead to product failure, fire, or electric shock.

READ ALL INSTRUCTIONS BEFORE USING THE APPLIANCE.

- Unplug the power plug if there is a noise, smell or smoke coming from the air conditioner. Failure to do so may result in explosion or fire.
- Make sure to ventilate sufficiently when this air conditioner and a heating appliance such as a heater are used simultaneously. Failure to do so may result in fire, serious injury, or product failure.
- Make sure that children do not climb on or hit the outdoor unit. Failure to do so may result in death or product failure.
- Do not turn the air conditioner on or off by plugging in or unplugging the power plug. It may result in fire or electric shock.
- If there is a gas or Freon leak, ventilate sufficiently before using the air conditioner again. Failure to do so may result in explosion or fire.
- Using the product for special purposes, such as preserving foods, works of art, etc. may result in death, fire, or electric shock. It is a consumer air conditioner, not a precision refrigeration system.
- Do not block the inlet or outlet of air flow. It may result in explosion or product failure.
- Do not insert hands or other objects through the air inlet or outlet while the air conditioner is operating. It may result in electric shock or serious injury.
- Do not expose people, animals, or plants to the cold or hot wind from the air conditioner for prolonged amounts of time. It may result in serious injury.
- Do not drink the water drained from the air conditioner. It may result in serious health complications.

Maintenance

- Turn the main power off and unplug the power plug when you clean or repair the air conditioner. Failure to do so may result in death, serious injury, or product failure.

**CAUTION****Installation**

- Install the outdoor unit on the north side to prevent the outside unit from being in direct sunlight. Do not place the indoor unit in direct sunlight from windows. Excessive sunlight may result in product failure.
- Safely dispose of packing materials such as screws, nails or batteries in a packing bag after installation or repair. It may result in serious injury.
- Do not install the air conditioner where it will be exposed to sea wind (salt spray) directly. It may result in product failure.
- Install the drain hose properly for smooth drainage of condensed water. Failure to do so may result in product failure.
- Install the air conditioner where the noise from the outdoor unit or the exhaust gas will not inconvenience the neighbors. Failure to do so may result in conflict between neighbors.
- Be cautious when you unpack or install the air conditioner. Failure to do so may result in serious injury or product failure.
- Do not touch the refrigerant leakage during installation or repair. It may result in product failure.
- Transport the air conditioning unit with two or more people or use a forklift. Failure to do so may result in serious injury.

Use

- Remove the batteries when the remote control is not in use for an extended period of time. Failure to do so may result in product failure.
- Make sure that the filter is installed before you operate the air conditioner. Failure to do so may result in product failure.
- Unplug the power plug when the air conditioner is not used for an extended period of time. Failure to do so may result in product failure.
- Make sure to check if there is a refrigerant leak after you install or repair the air conditioner. Failure to do so may result in product failure.
- Do not place any objects on the air conditioner. It may result in product failure.
- If there is a refrigerant leak during the installation of the air conditioner, ventilate the area immediately. Failure to do so may result in serious injury or product failure.
- Follow the standards of the corresponding region or country for handling the refrigerant and the air conditioner as well as for disassembling the air conditioner. Failure to do so may result in product failure.
- Do not mix the batteries for the remote control with other types of batteries or mix new batteries with used batteries. It may result in product failure.
- Do not recharge or disassemble the batteries. It may result in explosion, fire or serious injury.
- Do not dispose of the batteries in fire. It may result in explosion or fire.
- Stop using the remote control if there is a battery fluid leak. If your clothes or skin are exposed to the battery fluid from a leak, wash it off with clean water. Failure to do so may result in serious injury.
- If you swallow the battery fluid from a leak, wash out the inside of your mouth thoroughly and then consult a doctor. Failure to do so may result in serious health complications.
- Do not let the air conditioner run for a long time when the humidity is very high or when a door or window has been left open. It may result in product failure.
- Do not use the product for special purposes, such as preserving foods, works of art, etc. It is a consumer air conditioner, not a precision refrigeration system. There is risk of damage or loss of property.

Maintenance

- Do not use strong cleaning agents, solvents, or water when you clean the indoor air conditioner, as these may result in serious injury or product failure. Instead, use a smooth, dry cloth to clean the surfaces of the indoor unit and contact a qualified HVAC technician to clean the outdoor unit.
- Never touch the metal parts of the air conditioner when you remove the air filter. It may result in serious injury or product failure.
- Use a sturdy stool or ladder when you clean, maintain or repair the air conditioner at a height. Failure to do so may result in serious injury or product failure.

SAVE THESE INSTRUCTIONS

TABLE OF CONTENTS

2 TIPS FOR SAVING ENERGY

3 IMPORTANT SAFETY INSTRUCTIONS

8 BEFORE USE

- 8 Components
- 10 Using the remote control
- 11 - Inserting batteries
- 11 - Installing the remote control holder
- 11 Setting the current time
- 11 °C/°F Conversion

12 BASIC FUNCTIONS

- 12 Cooling your room
- 12 Heating your room
- 12 Removing humidity
- 13 Airing your room
- 13 Adjusting the fan speed
- 13 Adjusting the air flow direction
- 13 Using the 1 Touch soft air
- 14 Setting the timer
- 14 - Turning on the air conditioner automatically at a set time
- 14 - Turning off the air conditioner automatically at a set time
- 14 - Canceling the timer setting
- 14 - Setting sleep mode

15 ADVANCED FUNCTIONS

- 15 Changing room temperature quickly
- 15 Auto Clean operation
- 16 Auto Changeover operation
- 16 Auto operation
- 17 Energy saving cooling mode
- 17 Display screen brightness
- 17 Operating the air conditioner without the remote control
- 18 Restarting the air conditioner automatically
- 19 LG Smart AC (Optional)

20 MAINTENANCE

- 20 When not in use
- 22 Cleaning the air filter
- 22 Cleaning the 3M Filter

23 TROUBLESHOOTING

- 23 Self-diagnosis function
- 23 Before requesting service
- 26 Function of wired remote control

BEFORE USE

Components

Indoor unit

[Standard Libero Type]

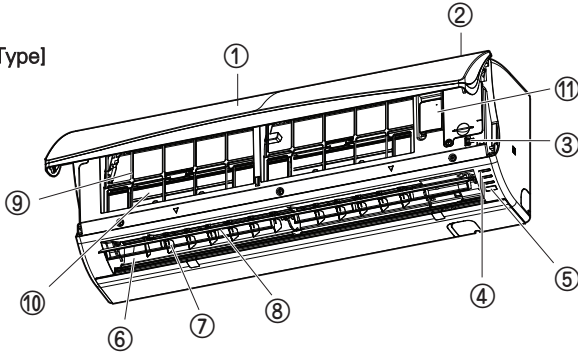

[Artcool Libero Type]

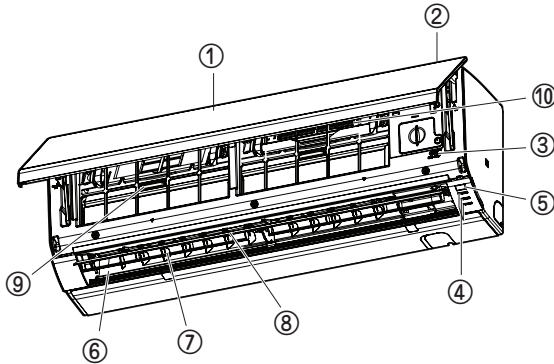

* Features may change according to the type of model.

①	Front grille (Front cover)	②	Air inlet	③	ON/OFF button
④	Operation lamp	⑤	Signal Receiver	⑥	Air outlet
⑦	Vertical louver	⑧	Horizontal vane	⑨	Air filter
⑩	3M filter	⑪	Wi-Fi Module (Sold separately)		

NOTE

- The number of operation lamps and their locations may vary according to the model of the air conditioner.
- The Wi-Fi Module, an optional accessory (sold separately), is required to enable Wi-Fi connectivity.
- Wi-Fi is available on single zone wall mounted models.

Outdoor unit

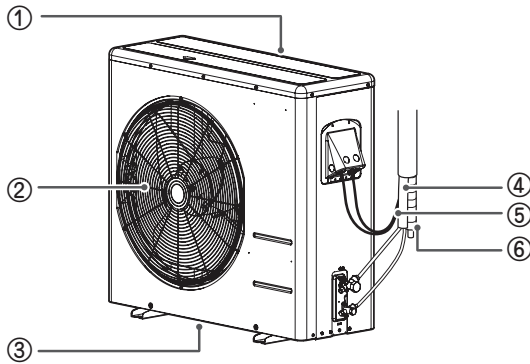
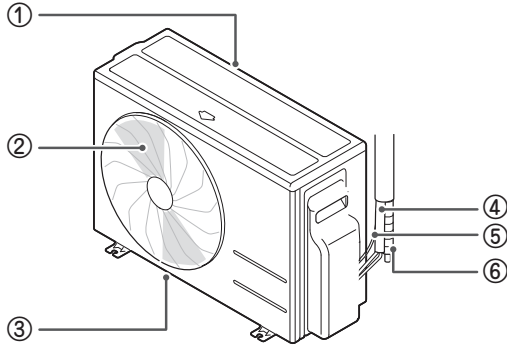

* Features may change according to the type of model.

①	Air inlet vents	②	Air outlet vents	③	Base plate
④	Refrigerant pipes	⑤	Connection wires	⑥	Drain hose

Using the remote control

You can operate the air conditioner more conveniently with the remote control.

Wireless remote control

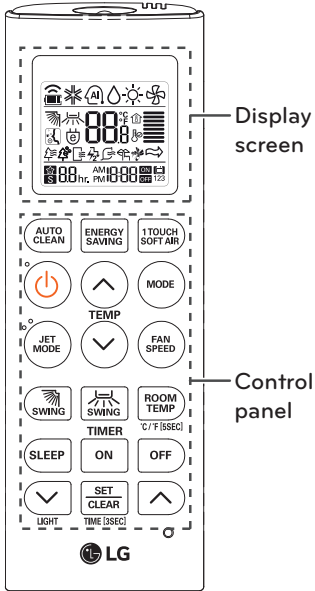

Control panel	Display screen	Description
 		Functions button* : Sets the special functions. : Auto clean : Energy saving cooling operation.
		1 Touch soft air button : Easily adjust the air flow to deflect direct wind away.
	-	On/Off button : Turn the power on/off.
 		Temperature adjustment buttons : Adjust the room temperature when cooling and heating.
		Operation mode selection button* : Select the operation mode. Cooling operation (❄️) / Auto operation or auto changeover (Ⓐ) / Dehumidifying operation (💧) / Heating operation (☀️) / Air circulation operation (🌀)
		Jet cooling/heating button* : Warm up or cool down the indoor temperature within a short period of time.
		Indoor fan speed button : Adjust the fan speed.
 		Air flow direction buttons : Adjust the air flow direction vertically or horizontally.
		Temperature display button : Display the room temperature. Also change unit from °C to °F if held for 5 seconds.
		Sleep mode auto button : Set the sleep mode auto operation.
 		Time buttons : Set the start / end time.
	-	Light button : Adjust the brightness of the indoor unit display.
	-	Set/clear button : Set or cancel functions. Also set the current time if held for 3 seconds.
	-	Reset button : Reset the air conditioner settings.

* Some functions may not be supported, depending on the model.

Inserting batteries

Insert AAA (1.5 V) batteries before using the remote control.

- 1 Remove the battery cover.

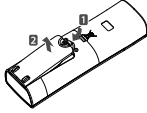

- 2 Insert the new batteries and make sure that the + and - terminals of the batteries are installed correctly.

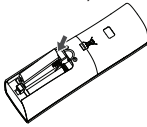

- 3 Reattach the battery cover.

! NOTE

If the display screen of the remote control starts to fade, replace the batteries.

Installing the remote control holder

To protect the remote control, install the holder where there is no direct sunlight.

- 1 Choose a safe and easily-accessible place.
- 2 Fix the holder by fastening the 2 screws firmly with a screwdriver.



- 3 Slide the remote control into the holder.



Operating method

Point the remote control towards the signal receiver at the bottom of the air conditioner to operate it.

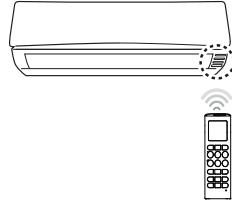

! NOTE

- The remote control may operate other electronic devices if pointed towards them. Make sure to point the remote control towards the signal receiver of the air conditioner.
- For proper operation, use a soft cloth to clean the signal transmitter and receiver.
- Jet mode in Heating does not work when equipped with a wired remote controller.
- ON/OFF reserve mode does not work when equipped with a wired remote controller.

Setting the current time

- 1 Press **SET/CLEAR** and hold it for longer than 3 seconds.
- The AM/PM icon flickers at the bottom of the display screen.



- 2 Press **↓** or **↑** to select the minutes.
- 3 Press **SET/CLEAR** to finish.

°C/°F Conversion

The unit switches between °C to °F or from °F to °C if The Temperature Display Button (**MODE**) is pressed for 5 seconds.

BASIC FUNCTIONS

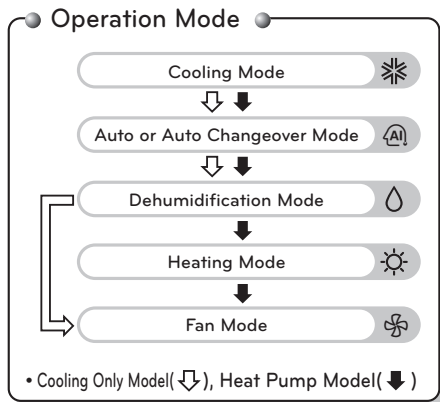

- Press or to set the desired temperature between 60°F (16°C) and 86°F (30°C).

NOTE

Cooling-only models do not support this function.

Removing humidity (Dehumidifying operation)

Dehumidifying mode prevents the growth of mold by removing excess moisture from an area with high humidity. This mode adjusts the room temperature and the fan speed automatically to maintain the optimal level of humidity.

- Press to turn on the power.
- Press until is displayed on the display screen.

Cooling your room (Cooling operation)

- Press to turn on the power.
- Press until is displayed on the display screen.

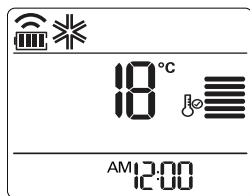

- Press or to set the desired temperature between 64°F (18°C) and 86°F (30°C).

Heating your room (Heating operation)

- Press to turn on the power.
- Press until is displayed on the display screen.

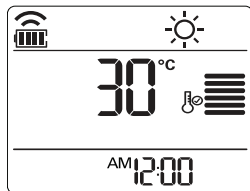



NOTE

- In this mode you cannot adjust the room temperature, as it is adjusted automatically. Also, the room temperature is not displayed on the display screen.

Airing your room (Air Circulation operation ; Fan mode)



This mode only circulates the indoor air without changing the room temperature. The cooling lamp lights up in air circulation mode.

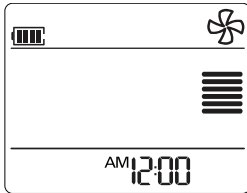





- 1 Press  to turn on the power.
- 2 Press  until  is displayed on the display screen.







- 3 Press  to adjust the fan speed.

Adjusting the fan speed



- 1 Press  repeatedly to adjust the fan speed.
 - Select  if you want natural wind. The fan speed alternates randomly to mimic a natural breeze.

Remark	Speed
	High
	Medium - High
	Medium
	Medium - Low
	Low
	Natural Wind

Adjusting the air flow direction





- 1 To adjust the direction of the air flow vertically, press  repeatedly and select the desired direction.
 - Select  to adjust the direction of the air flow automatically.
- 2 To adjust the direction of the air flow horizontally, press  repeatedly and select the desired direction.
 - Select  to adjust the direction of the air flow automatically.

! NOTE



- Adjusting the air flow direction horizontally may not be supported, depending on the model.
- Adjusting the air deflector arbitrarily may cause product failure.
- If you restart the air conditioner, it starts to operate with the previously set direction of air flow, so the air deflector may not match the icon displayed on the remote control. When this occurs, press  or  to adjust the direction of the air flow again.

Using the 1 Touch soft air (Comfort Vane operation)

The Comfort Vane option conveniently sets the vane to a preset position that deflects the supply air away from blowing directly onto room occupants. Vane preset positions will vary depending on the unit's operating mode (cooling or heating).

- 1 Press  to turn on the power.
- 2 Press .
 -  is displayed on the screen in cooling, fan and dehumidifying operation.
 -  is displayed on the screen in heating operation.

! NOTE

- This feature is not available in Auto or Auto changeover operation.
- Pressing ,  or  during comfort vane operation will turn off the comfort vane feature.
- When this feature is off, the horizontal vane operates automatically depending on the set mode.

Setting the timer

You can use the timer function to save energy and to use the air conditioner more efficiently.

Turning on the air conditioner automatically at a set time

- 1 Press **ON**.
- The icon below flickers at the bottom of the display screen.

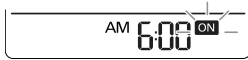

- 2 Press **↓** or **↑** to select the minutes.
- 3 Press **SET/CLEAR** to finish.

Turning off the air conditioner automatically at a set time

- 1 Press **OFF**.
- The icon below flickers at the bottom of the display screen.

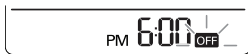

- 2 Press **↓** or **↑** to select the minutes.
- 3 Press **SET/CLEAR** to finish.

Canceling the timer setting

- 1 Press the timer function you want to cancel and then press **SET/CLEAR**.
- To cancel all timer settings, press and hold **SET/CLEAR**.

Setting sleep mode

Use the sleep mode to turn off the air conditioner automatically when you go to sleep.

- 1 Press **⏻** to turn on the power.
- 2 Press **SLEEP**.
- 3 Press **↓** or **↑** to select the hour (up to 7 hours).
- 4 Press **SET/CLEAR** to finish.
- **🌙** is displayed on the display screen in sleep mode.

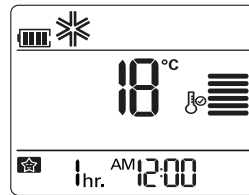



NOTE

In the Cooling and Dehumidifying modes, the temperature increases by 2 °F (1 °C) after 30 minutes and by a further 2 °F (1 °C) after another 30 minutes for a more comfortable sleep. The temperature increases up to 4 °F (2 °C) from the pre-set temperature.

ADVANCED FUNCTIONS

Changing room temperature quickly

This mode allows you to cool indoor air quickly in the summer or warm it quickly in the winter.

- 1 Press  to turn on the power.
- 2 Press .
 - **Po** is displayed on the display screen.

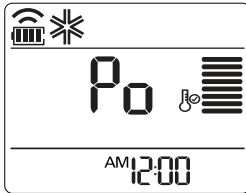



- In jet cooling mode, strong air blows out at a temperature of 64 °F (18 °C) for 30 minutes.
- In jet heating mode, strong air blows out at a temperature of 86 °F (30 °C) for 30 minutes.

! NOTE

- The Jet function cannot be used in Fan, Auto, or Auto Changeover modes.
- This function may not be supported, depending on the model.

Auto Clean operation

In the cooling and dehumidifying operations, moisture is generated inside the indoor unit. Use the auto cleaning function to remove such moisture.

- 1 Press .
 -  is displayed on the display screen.

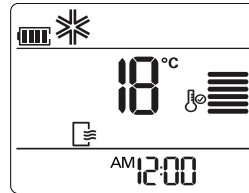

- If you turn off the power, the fan operates for 30 minutes and cleans the inside of the indoor unit.



! NOTE

Some buttons cannot be used while the auto cleaning function is in operation.



Auto Changeover operation

Single zone wall mounted models

This mode changes the operation mode automatically to maintain the set temperature at $\pm 4^{\circ}\text{F}$ (2°C).

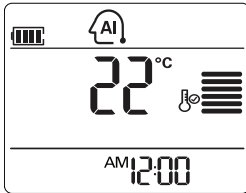
- 1 Press  to turn on the power.
- 2 Press  until  is displayed on the display screen.



- 3 Press  or  to set the desired temperature between 64°F (18°C) and 86°F (30°C).
- 4 Press  repeatedly to select the fan speed.

! NOTE

This function may not be supported, depending on the model.

Auto Operation

Multi models

In this operation mode, the system is automatically operated by the electronic controls.





- 1 In this operation mode, the system is automatically operated by the electronic controls.
 - You can set the desired temperature between 64°F (18°C) and 86°F (30°C) for Auto Operation mode.

! NOTE

This function properly operates when you use the remote controller matching each model.

Energy saving cooling mode

This mode minimizes power consumption during cooling and increases the set temperature to the optimal level for a more comfortable environment.

- 1 Press  to turn the power on.
- 2 Press  repeatedly to select the cooling operation.
 -  is displayed on the display screen.
- 3 Press .
 -  is displayed on the display screen.

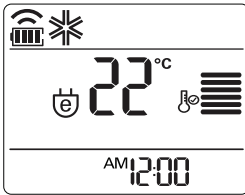

NOTE

This function may not be supported, depending on the model.

NOTE

- It is possible that the air conditioner and remote control may display different temperatures during this operation.

Display screen brightness

You can adjust the brightness of the indoor unit display screen.

- 1 Press  to turn on/off the display screen.

NOTE

This function may not be supported, depending on the model.

Operating the air conditioner without the remote control

You can use the On/Off button of the indoor unit to operate the air conditioner when the remote control is unavailable. However, the fan speed is set to high.

- 1 Open the front cover.
 - Lift up both sides of the cover slightly.

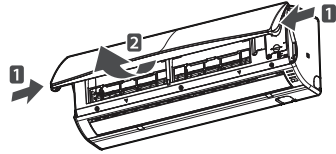

* Features may change according to the type of model.

- 2 Press the On/Off button.

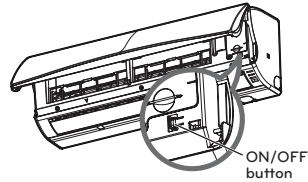

* Features may change according to the type of model.

- For cooling and heating models, the operation mode changes based on the room temperature as indicated in the table below.

Room temp.	Set temp.	Operation mode
Below 70°F (21°C)	75°F (24°C)	Heating operation
Above 70°F (21°C) and below 75°F (24°C)	73°F (23°C)	Dehumidifying operation
Above 75°F (24°C)	72°F (22°C)	Cooling operation

- Cooling-only models are set to 72°F (22°C).

Restarting the air conditioner automatically

When the air conditioner is turned on again after a power failure, this function restores the previous settings. This function is a factory default setting.

Disabling auto restart

- 1 Open the front cover.
 - Lift up both sides of the cover slightly.

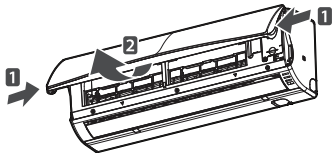

* Features may change according to the type of model.

- 2 Press the On/Off button and hold it for 6 seconds.
 - The unit will beep twice and the lamp will blink twice 4 times.

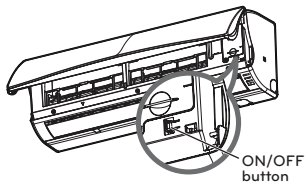

* Features may change according to the type of model.

- To re-enable the function, press the On/Off button and hold it for 6 seconds. The unit will beep twice and the blue lamp will blink 4 times.

NOTE

If you press and hold the On/Off button for 3 – 5 seconds instead of 6 seconds, the unit will switch to the test operation. In the test operation, the unit blows out strong air for cooling for 18 minutes and then returns to the factory default settings.

LG Smart AC (Optional)

LG Smart AC uses a wireless adapter Wi-Fi that allows the user to control the unit with the LG mobile app.

- * Limited to the Wi-Fi applied model
- * Wi-Fi is available on single zone wall mounted models.

Minimal Specifications

- Android OS 4.0 or higher at 320 x 480 or higher screen resolution.
- iOS 6 or higher at 960 x 640 or higher screen resolution.

Some phones meeting the above criteria may not operate every function of the unit, but phones below this minimum specification cannot operate the unit.

Supported wireless routers

CISCO, APPLE, ASUS, D-LINK, TP LINK, TRENDNET, ACTIONTEC, NETGEAR, 2WIRE

Other routers are not supported for the Wi-Fi application.

The above models are optimized for the Wi-Fi service, but any device that does not meet the minimum system requirements will not be able to run the program.

! NOTE

The Wi-Fi app is only compatible with smart phones and is not available for laptops or tablets.

User Guide

- The mobile App will continue to be updated with design and content improvements. Check for updates at the Play Store or the App Store.
- Some models of Wi-Fi-capable units will not have every function available through the mobile App remote control.
- Once the registration mode is set, "Preheating" blinks on the display of the unit.
- You can check Wi-Fi connection on your app or module after finish the registration.

Setting the Environment

- 1 Search and download 'LG Smart AC' in Google play or App store.
- 2 Become a member in LG Smart AC app or web site.
 - North America : <http://us.smarthinq.com>
 - Canada : <http://ca.smarthinq.com>
- 3 Please log in and register the product.
 - For detail usage guide, refer to the installation manual enclosed in LG Smart AC box.

! NOTE

- The Wi-Fi Module (PCRCUDT3), an optional accessory (sold separately), is required to enable Wi-Fi connectivity.
- For details, refer to the following web site.
 - North America : <http://us.smarthinq.com>
 - Canada : <http://ca.smarthinq.com>

MAINTENANCE

Clean the product regularly to maintain optimal performance and to prevent possible breakdown.

When not in use

If the air conditioner will not be used for an extended of time, dry the air conditioner to maintain it in best condition.

- 1 Dry the air conditioner in Fan mode for 3 to 4 hours and disconnect the power to the unit. There may be internal damage if moisture is left in components.
- 2 Before using the air conditioner again, dry the inner components of the air conditioner in Fan mode for 3 to 4 hours. This will help to remove odor which is generated from moisture.

[Standard Libero Type]

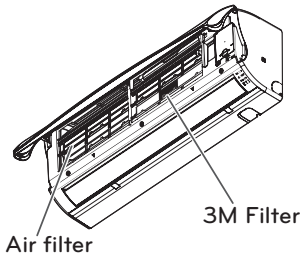

[Artcool Libero Type]

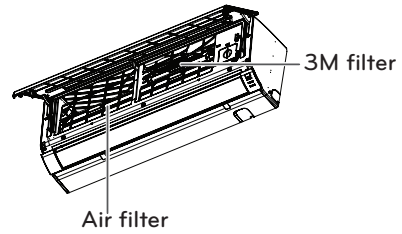

* Features may change according to the type of model.

Type	Description	Interval
Air filter	See "Cleaning the air filter."	2 weeks
3M Filter	See " Cleaning the 3M Filter "	1 month
Indoor unit	Clean the Indoor unit surface by using a soft, dry cloth.	Regularly
	Replace the remote control batteries.	Once a year
	Have a professional clean the condensate drain pipe.	Every 4 months
	Have a professional clean the condensate drain pan.	Once a year
Outdoor unit	Have a professional clean the heat exchanger coils and the panel vents.	Once a year
	Have a professional clean the fan.	Once a year
	Have a professional clean the condensate drain pan.	Once a year
	Have a professional verify that all the fan assembly is firmly tightened.	Once a year

**CAUTION**

- Turn off the power before you perform any maintenance; otherwise it may cause electric shock.
- Never use water that is hotter than 104°F (40°C) when you clean the filters. It may cause deformation or discoloration.
- Never use volatile substances when you clean the filters. They may damage the surface of the product.
- Do not wash the 3M Filter with water, because the filter can be damaged.

**NOTE**

- The location and shape of the filters may differ, depending on the model.
- Make sure to clean the heat exchanger coils of the outdoor unit regularly, as dirt collected in the coils may decrease the operational efficiency or increase energy costs.

Cleaning the air filter

Clean the air filter once every 2 weeks or more if necessary.

- 1 Turn off the power to the unit.
- 2 Open the front cover.
 - Lift up both sides of the cover slightly.

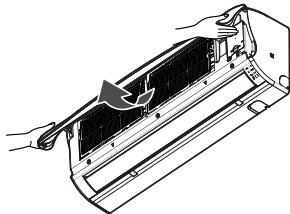

* Features may change according to the type of model.

- 3 Hold the knob of the air filter, lift it up slightly and remove it from the unit.

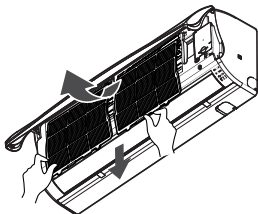

* Features may change according to the type of model.

- 4 Clean the filter with a vacuum cleaner or with warm water.
 - If dirt is difficult to remove, wash the filter in lukewarm water with detergent.
- 5 Dry the filter in the shade.

Cleaning the 3M Filter

- 1 Turn off the power to the unit.
- 2 Open the front cover and remove the air filter (see "Cleaning air filter").
- 3 Remove the 3M Filter.

[Standard Libero Type]

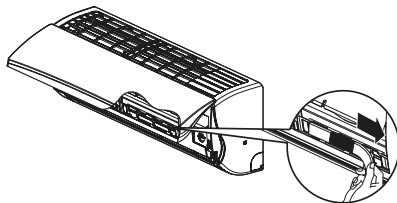

[Artcool Libero Type]

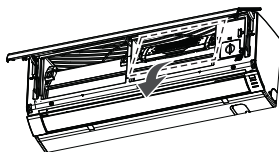

* Features may change according to the type of model.

- 4 Use a vacuum cleaner to remove dirt, Do not wash the 3M Filter with water, because the filter can be damaged.

! NOTE

- We suggest changing the 3M Filter every 6 Months
- The location of the filters may differ, depending on the model.
- If you need more filters, please contact the LG service center (refer to the warranty card)

TROUBLESHOOTING

Self-diagnosis function

This product has a built-in self-diagnosis function. If an error occurs, the lamp of the indoor unit will blink in 2 second intervals. If this occurs, contact your local dealer or service center.

Before requesting service

Please check the following before you contact the service center. If the problem persists, contact your local service center.

Problem	Possible causes	Corrective action
Abnormal operating conditions.	<ul style="list-style-type: none"> There is a burning smell and a strange sound coming from the unit. 	<ul style="list-style-type: none"> Turn off the air conditioner, unplug the power cord, and contact a qualified HVAC technician.
	<ul style="list-style-type: none"> Water leaks from the indoor unit even when the humidity level is low. 	
	<ul style="list-style-type: none"> The power cord is damaged or generating excessive heat. 	
	<ul style="list-style-type: none"> A switch, a circuit breaker (safety, ground) or a fuse is not operated properly. 	
	<ul style="list-style-type: none"> The unit generates an error code from its self-diagnosis. 	
The air conditioner does not work.	<ul style="list-style-type: none"> The air conditioner is unplugged. 	<ul style="list-style-type: none"> Check whether the power cord is plugged into the outlet.
	<ul style="list-style-type: none"> A fuse is blown or the power supply is blocked. 	<ul style="list-style-type: none"> Replace the fuse or check if the circuit breaker has tripped.
	<ul style="list-style-type: none"> A power failure has occurred. 	<ul style="list-style-type: none"> Turn off the air conditioner when a power failure occurs. When the power is restored, wait 3 minutes, and then turn on the air conditioner.
	<ul style="list-style-type: none"> The voltage is too high or too low. 	<ul style="list-style-type: none"> Check if the circuit breaker has tripped.
	<ul style="list-style-type: none"> The air conditioner turned off automatically at a preset time. 	<ul style="list-style-type: none"> Press the power button again.
	<ul style="list-style-type: none"> Battery setting is wrong in the remote controller. 	<ul style="list-style-type: none"> Check to make sure that the batteries are inserted correctly in your remote control. If the batteries are placed correctly and the air-conditioner does not operate, replace the batteries and try again.

Problem	Possible causes	Corrective action
The air conditioner does not generate cool air.	<ul style="list-style-type: none"> • Air is not circulating properly. 	<ul style="list-style-type: none"> • Make sure that there are no curtains, blinds, or pieces of furniture blocking the front of the air conditioner.
	<ul style="list-style-type: none"> • The air filter is dirty. 	<ul style="list-style-type: none"> • Clean the air filter once every 2 weeks. • See “Cleaning Air Filter” for more information.
	<ul style="list-style-type: none"> • The room temperature is too high. 	<ul style="list-style-type: none"> • In the summer, it may take some time to cool the indoor air fully. In this case, select the Jet Cool operation to cool indoor air quickly.
	<ul style="list-style-type: none"> • Cold air is escaping from the room. 	<ul style="list-style-type: none"> • Make sure that no cold air is escaping through ventilation points in the room.
	<ul style="list-style-type: none"> • The desired temperature is higher than the set temperature. 	<ul style="list-style-type: none"> • Set the desired temperature to a level lower than the current temperature.
	<ul style="list-style-type: none"> • There is a heating source nearby. 	<ul style="list-style-type: none"> • Avoid using heat generators like electric ovens or gas burners while the air conditioner is in operation.
	<ul style="list-style-type: none"> • Air circulation operation is selected. 	<ul style="list-style-type: none"> • In the air circulation operation, air blows from the air conditioner without cooling or heating the indoor air. • Switch the operation mode to the cooling operation.
	<ul style="list-style-type: none"> • Outside temperature is too high. 	<ul style="list-style-type: none"> • The cooling effect may not be sufficient.
The air conditioner does not generate warm air. <i>Note : Heating is not available in all models.</i>	<ul style="list-style-type: none"> • When Heating Mode is started, the vane is almost closed and no air comes out, even though the outdoor unit is operating. 	<ul style="list-style-type: none"> • This symptom is normal. Please wait until the unit has prepared enough warm air to blow through the indoor unit.
	<ul style="list-style-type: none"> • The outdoor unit is in Defrosting Mode. 	<ul style="list-style-type: none"> • In heating mode, ice/frost is built up on the coils when the outside temperature fall down. This function removes a layer of frost on the coil, and should be complete in approximately 15 minutes.
	<ul style="list-style-type: none"> • Outside temperature is too low. 	<ul style="list-style-type: none"> • The heating effect may not be sufficient.
It is not possible to adjust the fan speed.	<ul style="list-style-type: none"> • The Auto Operation, Jet Operation, or Dehumidification Operation is selected. 	<ul style="list-style-type: none"> • In some operation modes you cannot adjust the fan speed. Select an operation mode in which you can adjust the fan speed.
It is not possible to adjust the temperature.	<ul style="list-style-type: none"> • The Air Circulation Operation or Jet Operation is selected. 	<ul style="list-style-type: none"> • In some operation modes you cannot adjust the temperature. Select an operation mode in which you can adjust the temperature.

Problem	Possible causes	Corrective action
The air-conditioner stops during operation.	<ul style="list-style-type: none"> The air conditioner is suddenly turn off. 	<ul style="list-style-type: none"> The Timer Function may have timed out, which turns the unit off. Check the timer settings.
	<ul style="list-style-type: none"> A power failure has occurred during operation. 	<ul style="list-style-type: none"> Wait for the power to come back. If you have the Auto Restart Function enabled, your unit will resume its last operation several minutes after the power is restored.
Indoor unit is still operating even when the power has been turned off.	<ul style="list-style-type: none"> Auto-Clean mode is being operated. 	<ul style="list-style-type: none"> Allow the Auto-Clean to continue as it removes any remaining moisture inside the indoor unit. If you do not want this feature to continue, you can turn the unit off.
The air outlet on the indoor unit is discharging mist.	<ul style="list-style-type: none"> The cooled air from the air conditioner makes mist. 	<ul style="list-style-type: none"> When the room temperature decreases, this phenomenon will disappear.
Water leaks from the outdoor unit.	<ul style="list-style-type: none"> In the heating operations, condensed water drop from the heat exchanger. 	<ul style="list-style-type: none"> This symptom need to install drain hose under the base pan. Contact the installer.
Operating noise or vibration.	<ul style="list-style-type: none"> Clicking sound Clicking sound can be heard either when the unit starts or stops due to movement of reversing valve. Creaking sound The plastic parts of the indoor unit creak when shrinking or expanding due to sudden temperature changes. Flowing or Blowing sound This is the flow of refrigerant through the air conditioner. 	<ul style="list-style-type: none"> These are normal symptoms. The noise will stop.
The indoor unit gives out odor.	<ul style="list-style-type: none"> Odors (such as cigarette smoke) may be absorbed into the indoor unit and discharged with airflow. 	<ul style="list-style-type: none"> If the smell does not disappear, you need to wash the filter. If this does not work, contact a qualified HVAC technician to clean your heat exchanger.

Function of wired remote control

Simple Wired Remote Controller [PQRCVCL0Q(W)/ PQRCHCA0Q(W)]	LG Programmable Thermostat [PREMTB10U]
<ul style="list-style-type: none">• It is not possible to set time for automatic on/off timer with the wireless remote control.	<ul style="list-style-type: none">• If permitting ACO function, the wired remote control will change air conditioning/heating operational mode.• It is not possible to set time for automatic on/off timer with the wireless remote control.



LGEUS
 LG Electronics, Air conditioning Division
 1000 Sylvan Ave., Englewood Cliffs, NJ 07632
 LGECI
 LG Electronics Canada Inc.
 20 NORELCO DRIVE. NORTH YORK, ONTARIO M9L 2X6.

LG Customer Information Center	
888-865-3026	USA, press #2 for PTAC, TTW
888-865-3026	USA, press #3 for DFS, Multi V
1-888-LG-Canada	CANADA
Register your product Online!	
www.lg.com	

US	1. Please call the installing contractor of your product, as warranty service will be provided by them. 2. If you have service issues that have not been addressed by the contractor, please call 1-888-865-3026.
CANADA	Service call Number # : (888) LG Canada, 1-888-542-2623