

**Range hood**

**Mistral/Bora**

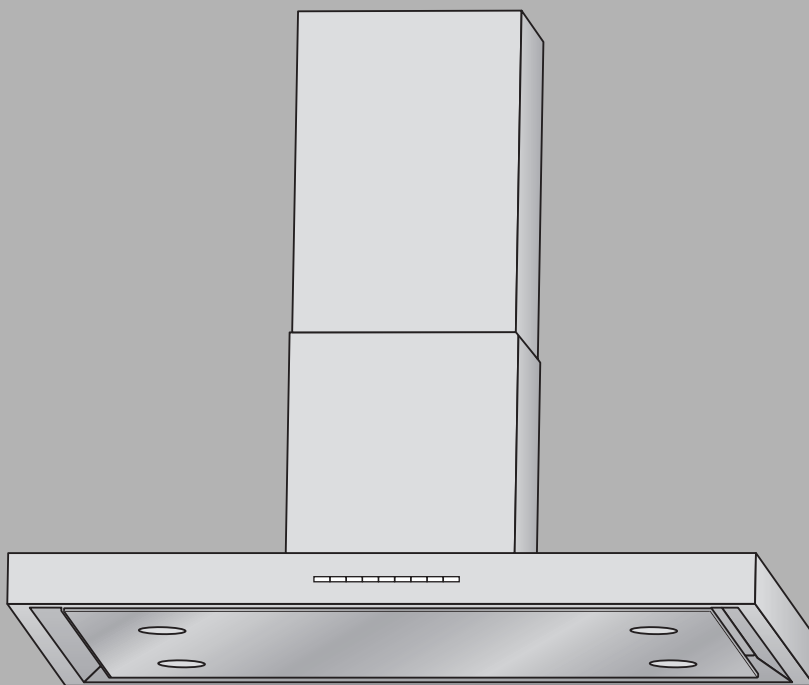

**Operating instructions**

Thank you for choosing to buy one of our products. Your appliance is made to high standards and is easy to use. Nevertheless, please take the time to read these operating instructions in order to familiarize yourself with the appliance and get the best use out of it.

**Please follow the safety precautions.**

## Modifications

Text, diagrams and data correspond to the technical standard of the appliance at the time these operating instructions went to press. The right to make technical modifications for the purpose of the further development of the appliance is reserved.

## Symbols used



**Denotes important safety precautions. Failure to observe said precautions can result in injury or damage to the appliance or fittings!**

- Indicates step-by-step instructions.
- Describes how the appliance reacts to the steps taken.
- Indicates a list.



Denotes useful tips for the user.

## Validity

The model number corresponds to the first 3 digits on the identification plate. These operating instructions apply to the models:

Type	Model no.	Type	Model no.
DW-M9	991	DI-M10	996
DW-M12	992	DI-M12	997
DW-B9	993	DI-B10	816
DW-B14	994	DI-B14	821

Variations depending on the model are noted in the text.

# Contents

<b>1</b>	<b>Safety precautions</b>	<b>4</b>
1.1	Before using for the first time	4
1.2	Correct use	5
1.3	Children in the home	5
1.4	Note on use	6
<b>2</b>	<b>Appliance description</b>	<b>8</b>
2.1	Extraction model	8
2.2	Recirculation model	8
2.3	Fitted with	9
2.4	Construction	10
2.5	Operating and display elements	11
<b>3</b>	<b>Use</b>	<b>12</b>
3.1	Switching on	12
3.2	Switching off	12
3.3	After-running time	12
3.4	Clean-Air function	13
3.5	Intensive level	13
3.6	Illumination	14
3.7	Saturation indicator for the grease filter	14
<b>4</b>	<b>Care and maintenance</b>	<b>15</b>
4.1	Cleaning the housing	15
4.2	Cleaning the grease filter	16
4.3	Cleaning and replacing the long-life activated charcoal filter	17
4.4	Replacing the halogen light	18
<b>5</b>	<b>Trouble-shooting</b>	<b>19</b>
5.1	What to do if ...	19
<b>6</b>	<b>Accessories and spare parts</b>	<b>21</b>
<b>7</b>	<b>Technical data</b>	<b>22</b>
<b>8</b>	<b>Disposal</b>	<b>23</b>
<b>9</b>	<b>Notes</b>	<b>24</b>
<b>10</b>	<b>Index</b>	<b>25</b>
<b>11</b>	<b>Repair service</b>	<b>27</b>

# 1 Safety precautions



**The appliance corresponds to recognised technology standards and the relevant safety regulations. Proper use of the appliance is however essential to avoid damage and accidents. Please therefore follow the precautions given in these operating instructions.**

In accordance with the requirements of IEC 60335-1:

- This appliance is not intended for use by persons (including children) with reduced physical, sensory or mental capabilities, or lack of experience and knowledge, unless supervised or unless they have been given instruction concerning the use of the appliance by a person responsible for their safety.

## 1.1 Before using for the first time

- The appliance must be installed and connected up to the electricity supply in accordance with the separate installation instructions. The necessary work should be done by a qualified fitter or electrician.
- Dispose of the packaging material in accordance with local regulations.
- Ensure the grease filters are properly installed.

## 1.2 Correct use

- The appliance is designed for use in the home for extracting cooking fumes and smells from above the cooking surface.
- Any repairs, modifications or manipulations to the appliance, especially any electrically live parts, should only be carried out by the manufacturer, its Customer Services or similarly qualified persons. Repairs if carried out incorrectly may cause serious injury, damage to the appliance and fittings, as well as affect the functioning of the appliance. If the appliance is not working properly or in case of a repair order, follow the instructions given in the **REPAIR SERVICE** section. Please contact our Customer Services if necessary.
- Use original spare parts only.
- Retain these operating instructions for future reference. If you sell or pass the appliance on to a third party, please ensure these operating instructions, together with the installation instructions, accompany the appliance. In this way, the new owner can inform themselves about how to use the appliance correctly and read the pertinent safety precautions.

## 1.3 Children in the home

- Packaging material e.g. plastic and polystyrene can be dangerous for children. Danger of suffocation! Please keep packaging material away from children.
- The appliance is designed for use by adults who are familiar with these operating instructions. Children are often unable to recognise the danger of electrical appliances. Ensure proper supervision and do not allow children to play with the appliance – there is a danger that children could hurt themselves.

### 1.4 Note on use

- If the appliance is visibly damaged, do not use it. Contact our Customer Services.
- If the appliance is not operating properly, disconnect it from the electricity supply immediately.
- If the mains cable of the appliance is damaged, it must be replaced by Customer Services in order to avoid hazard.
- Caution: Accessible parts may become hot when used with cooking appliances.
- Do not flambé food underneath the hood as the grease filters if laden with grease could catch fire.
- If frying on the cooking surface, do not leave the frying appliance unattended. The cooking oil in the frying appliance could overheat and catch fire. Constantly monitor the temperature of the cooking oil, keeping it below the temperature at which it can catch fire. Change the cooking oil regularly – dirty oil catches fire more easily than clean oil.
- Clean the filters regularly. Failure to do so can increase the fire hazard due to the build-up of grease in the grease filter.
- Do not operate the individual cooking zones of the cooking surface without a pan on them or with an empty pan on them so as to avoid damaging the appliance or the kitchen fittings through a build-up of heat. Avoid open fires with oil, gas, wood and coal fired cookers.
- Ensure there is adequate ventilation when the extraction fan is on so as to avoid creating a disturbing underpressure in the kitchen and to achieve optimal air extraction.
- Avoid a cross-current of air, which could blow the cooking vapours over the cooking area.

- If other appliances – fuelled by gas or other fuels – are being used at the same time, ensure that there is a sufficient supply of fresh air. This does not apply to air recirculation appliances.
- If other firing systems are being used at the same time (e.g. wood, gas, oil or coal-fired heating appliances), safe operation is only possible providing a room negative pressure of 4 Pa (0.04 mbar) is not exceeded at the location of the appliance. Risk of toxic fumes! An adequate flow of fresh air must be guaranteed e.g. via non-closable openings in doors or windows and in combination with an air-intake/exhaust-air wall box or by other technical means.
- When carrying out maintenance work on the appliance, including replacing the light bulb, cut off the electricity supply to the appliance (remove the screw fuse from the holder or switch the circuit breaker off, or disconnect from the mains supply).
- When cleaning the appliance make sure no water gets inside the appliance. Use a moderately damp cloth. Do not spray the inside or outside of the appliance with water. Do not use a steam cleaner. If water gets inside the appliance, it can cause damage.

## 2 Appliance description

The appliance is designed to extract cooking fumes and smells from the cooking area.

This particular model can be used to extract or recirculate air.

### 2.1 Extraction model

A fan extracts cooking fumes and smells from above the cooking surface. The metal grease filter cleans the extracted air, which is passed through a connecting pipe fitted with an integrated non-return valve and through the air duct to the outside.



When the appliance is in use, ensure there is a sufficient supply of fresh air to replace the air that is being extracted.

### 2.2 Recirculation model

The cooking fumes and smells are filtered over the metal grease filter through an activated charcoal filter and the filtered air is then circulated back into the room through the side openings.



If activated charcoal filters are not supplied with the appliance, these should be ordered and installed before using the appliance.

Moisture is not taken out of the air.

## 2.3 Fitted with

- 1 extraction fan
- Illumination
- 1 metal grease filter
- 1 long-life activated charcoal filter

The extraction fan has 4 power levels.

- **1** = Low, **2** = Medium, **3** = High and **Int** = Intensive level.
- Power levels 1–3 can be used for longer periods of operation.
- The intensive level is for shorter bursts of intensive extraction of the cooking fumes and smells, e. g. when searing meat. The intensive level runs for 5 minutes at a time.

## 2.4 Construction

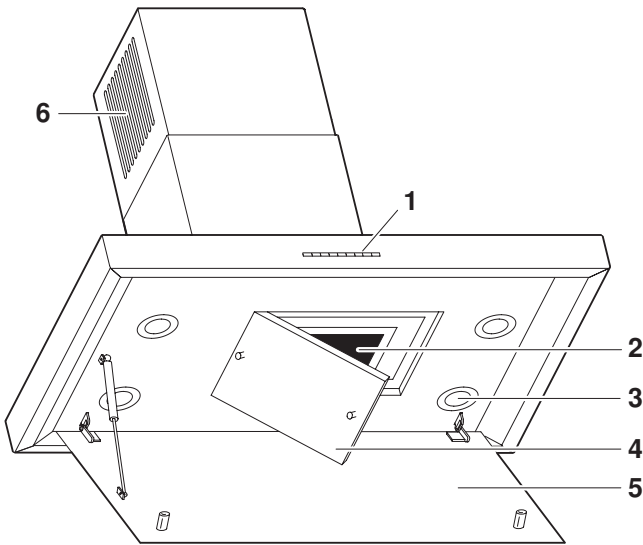

- 1 Operating and display elements
- 2 Long-life activated charcoal filter (for recirculating air only)
- 3 Halogen light
- 4 Metal grease filter
- 5 Glass panel, fold-away (only Mistral)
- 6 Air recirculation (for recirculating air only)

## 2.5 Operating and display elements



**1** Power level 1 on/off

**2** Power level 2 on/off

**3** Power level 3 on/off

**Int** Intensive level on/off

 After-running time/Clean-Air function

 Illumination on/off/dimmed

 Grease filter saturation indicator



Depending on the model and design, the specification of the appliance may differ from the standard specification described herein.

## 3 Use

### 3.1 Switching on

- ▶ Press the **1** / **2** / **3** or **Int** button to switch the appliance on.
- ▶ Select a different power level by pressing the corresponding button.
  - The indicator light shows which power level is currently being used **1** / **2** / **3** or **Int** .





We recommend switching the appliance on several minutes before cooking and allowing it to run for at least another 5 minutes after you have finished cooking. Use a low power level for normal cooking smells and a higher power level for very strong cooking fumes and smells.

### 3.2 Switching off

To switch the appliance off, press the power level currently being used again.

### 3.3 After-running time



- ▶ Press the  button to activate the after-running time.
  - The  button illuminates.
- After running for 5 seconds at level 3 and then level 2, the appliance runs for 15 minutes at level 1 and then switches off.



Press the **1** , **2** , **3** or **Int** button to stop the after-running time before the 15 minutes has elapsed.

## 3.4 Clean-Air function

### Activating the Clean-Air function

- ▶ Hold the  button depressed for 5 seconds.
  - The  display flashes.
  - The clean air function remains activated until it is manually deactivated.





Power level  runs for 15 minutes every hour.

When in use, ensure there is a sufficient supply of fresh air to replace the air that is being extracted.



The appliance can be used as normal when the Clean-Air function is activated. When the power level is switched off the appliance reverts to the Clean-Air mode.

### Deactivating the Clean-Air function

- ▶ Hold the  button depressed for 5 seconds.
  - The  display goes out.

## 3.5 Intensive level

The intensive level can be selected when the appliance is switched on or off.



- ▶ Press the  button to switch on the intensive level for 5 minutes.
  - The  button illuminates.



After 5 minutes the appliance switches back to level 3.

Press the  /  /  or  button to stop the intensive level before the 5 minutes has elapsed.

### 3.6 Illumination

- ▶ Press the  button to switch the illumination on or off.
- ▶ Hold the  button depressed to dim the light.



The illumination can be used on its own.

### 3.7 Saturation indicator for the grease filter

The  display illuminates after 15 operating hours or at the latest 14 days after first being put into operation. The saturation level is reached. The grease filter must be cleaned.

- ▶ After cleaning, hold the  button depressed for at least 5 seconds.
  - The display goes out.

## 4 Care and maintenance

### 4.1 Cleaning the housing



**Take care that no water gets into the housing! If water gets into the housing, it can cause damage.**

**Do not use abrasive cleaners, scouring pads, steel wool etc. to clean the appliance as they can damage the surface.**

**Remove screw fuse for appliance or switch off circuit breaker.**

#### **Cleaning the outside/inside**

- Clean the outside using a slightly damp cloth – and detergent if necessary – and wipe dry.

Grease and condensate water can build up around the grease filter on the inside.

- Clean using a slightly damp cloth – and detergent if necessary – and wipe dry.

## 4.2 Cleaning the grease filter



**The accumulation of grease in the grease filter can present an increased fire hazard.**

The grease filter should be cleaned weekly with normal use, or once every two weeks at a minimum. If properly cared for, a grease filter should provide unlimited years of service.

### Mistral

- Carefully fold down the glass panel.

### Mistral and Bora

- Pull down and remove the grease filter **1**.



For washing in a dishwasher, select an «intensive» or «heavy» wash – with a warm pre-wash.

Cleaning may cause the grease filter to become discoloured. However, this will not affect the functioning of the filter in any way.

- After cleaning, reinstall the grease filter **1**.

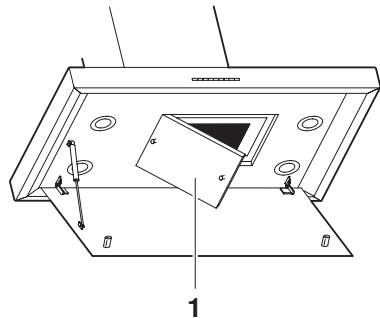

### Mistral

- Carefully fold the glass panel up again.

### Mistral and Bora

- After cleaning, hold the  button depressed for at least 5 seconds.
  - The display goes out.

### 4.3 Cleaning and replacing the long-life activated charcoal filter



Long-life activated charcoal filters are only used in the recirculation model.

The long-life activated charcoal filter can be cleaned and reactivated. The long-life activated charcoal filter should be changed ever month with normal use or whenever the  indicator illuminates. The filter can be cleaned in a dishwasher at 65 °C (select an «intensive» or «heavy soil» wash programme). Wash the filter separately so that it does not become clogged with food particles. If it is not possible to wash the filter in a dishwasher, soak the filter in 60 °C water and detergent for one hour. Then rinse well. To reactivate the activated charcoal, dry the filter without the frame in the oven.

- Select top and bottom heat or hot air and set the temperature to 100 °C. Place the filter on a wire shelf and allow to dry for 60 minutes.



The long-life activated charcoal filter needs to be replaced after about 3 years as its ability to absorb odours declines. The spent long-life activated charcoal filter can be disposed of in the household waste.

- Remove and clean the grease filter.
- Remove the long-life activated charcoal filter **1** from the bottom.
- Remove, clean, reactivate and replace the filter **2** back into the frame **3**. Take care not to damage the filter. If necessary, replace the used long-life activated charcoal filter by a new one.
- Replace the long-life activated charcoal filter **1**.
- Replace the grease filter.
- After cleaning, hold the  button depressed for at least 5 seconds.
  - The display goes out.

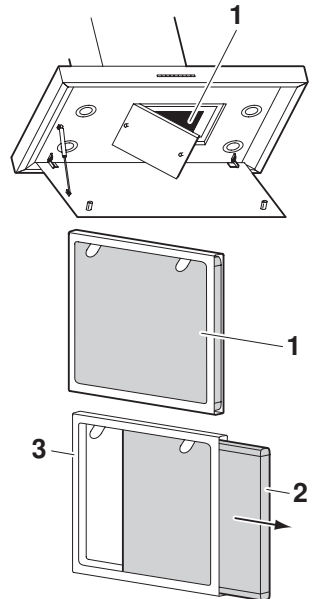

## 4.4 Replacing the halogen light



**Remove screw fuse for appliance or switch off circuit breaker.  
Halogen lights get hot during operation! Allow to cool down first.**

### Mistral

- Carefully fold down the glass panel.

### Mistral and Bora

- Using a small screw driver, carefully remove the ring.
- Replace the defective halogen light with a bulb of the same type (max. 20 watts).



Avoid touching the new halogen light with bare hands. Use a soft, dry and grease-free cloth.

- Clean the ring and the glass.
- Fit the ring and the glass back into the openings.

### Mistral

- Carefully fold the glass panel up again.

### Mistral and Bora

- Put back screw fuse or switch on circuit breaker again.

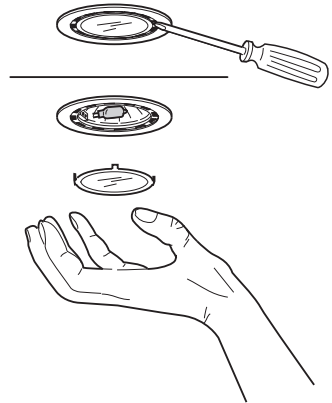

# 5 Trouble-shooting

## 5.1 What to do if ...

### ... the illumination is not working

Possible cause	Solution
<ul style="list-style-type: none"><li>• Fuse or circuit breaker for electrical installations in the home is faulty.</li></ul>	<ul style="list-style-type: none"><li>➤ Replace the fuse.</li><li>➤ Reset the circuit breaker.</li></ul>
<ul style="list-style-type: none"><li>• Interruption in the power supply.</li></ul>	<ul style="list-style-type: none"><li>➤ Check the power supply.</li></ul>
<ul style="list-style-type: none"><li>• The halogen light is faulty.</li></ul>	<ul style="list-style-type: none"><li>➤ Replace the halogen light.</li></ul>

### ... the appliance is not extracting enough air

Possible cause	Solution
<ul style="list-style-type: none"><li>• Grease filter is dirty.</li></ul>	<ul style="list-style-type: none"><li>➤ Clean the grease filter.</li></ul>
<ul style="list-style-type: none"><li>• The activated charcoal filter (in the recirculation model) is spent.</li></ul>	<ul style="list-style-type: none"><li>➤ Change the activated charcoal filter.</li></ul>

... The  display illuminates

Possible cause	Solution
<ul style="list-style-type: none"><li>Grease filter is dirty.</li></ul>	<ul style="list-style-type: none"><li>▶ Clean grease filter.</li><li>▶ After cleaning, hold the  button depressed for at least 5 seconds.<ul style="list-style-type: none"><li>– The display goes out.</li></ul></li></ul>

... The  display flashes

Possible cause	Solution
<ul style="list-style-type: none"><li>Clean-Air function is activated.</li></ul>	<ul style="list-style-type: none"><li>▶ Hold the  button depressed for at least 5 seconds.<ul style="list-style-type: none"><li>– Clean-Air function is deactivated.</li><li>– The display goes out.</li></ul></li></ul>

## 6 Accessories and spare parts

Please give model number and exact description when ordering parts.

Halogen light

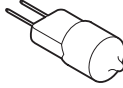

Metal grease filter

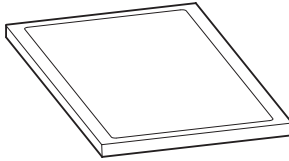

Long-life activated charcoal filter

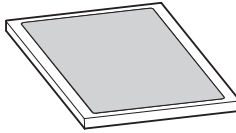

The halogen light is also available from specialist retailers.

## 7 Technical data

### Electrical connection

- See identification plate.
- Remove the grease filter.
  - The identification plate is located on the inside of the appliance.

# 8 Disposal

## Packaging

- All packaging materials (cardboard, plastic film (PE) and polystyrene (EPS)) are marked and should, if possible, be collected for recycling and disposed of in an environmentally friendly way.

## Disconnection

- Disconnect the appliance from the mains. With a fixed appliance, this is to be carried out by a qualified electrician!

## Safety

- Disable the appliance to prevent accidents caused by improper use, especially through children playing.
- Pull the plug out of the mains socket or have the appliance disconnected from the mains by a qualified electrician. Then cut off the mains cable.

## Disposal

- The old appliance should not be discarded as worthless rubbish. If disposed of correctly, the raw materials can be recovered for recycling.
- The  symbol on the identification plate warns that the appliance may not be disposed of in normal household waste.
- The appliance must be disposed of in accordance with local regulations on waste disposal. For more information on the handling, disposal and recycling of the product, please contact the local authorities, the local recycling facilities for household waste or the retailer from whom you purchased the appliance.

## 9 Notes

# 10 Index

## A

- Accessories . . . . . 21
  - Ordering . . . . . 27
- Activated charcoal filter . . . . . 8, 10
  - Long-life . . . . . 17
- After-running time . . . . . 12
- Appliance description . . . . . 8

## C

- Care . . . . . 15
- Children in the home . . . . . 5
- Clean-Air function . . . . . 13
- Cleaning
  - Inside of housing . . . . . 15
  - Outside of housing . . . . . 15
- Construction . . . . . 10

## D

- Disconnection . . . . . 23
- Display elements . . . . . 10, 11
- Disposal . . . . . 23

## E

- Electrical connection . . . . . 22
- Extraction model . . . . . 8

## F

- Fitted with . . . . . 9

## G

- Glass panel . . . . . 10
- Grease filter
  - Saturation indicator . . . . . 14

## H

- Halogen light . . . . . 10
  - Replacing . . . . . 18

## I

- Identification plate . . . . . 22
- Illumination
  - Switching on/off . . . . . 14
- Intensive level . . . . . 13

## L

- Light, dimming . . . . . 14
- Long-life activated charcoal filter . . . . . 17
  - Cleaning and changing . . . . . 17

## M

- Maintenance . . . . . 15
- Metal grease filter . . . . . 10
  - Cleaning . . . . . 16
  - Saturation indicator . . . . . 14
- Model no. . . . . 2

## O

- Operating elements . . . . . 10, 11
- Orders . . . . . 27

## P

- Packaging . . . . . 23

## Q

- Queries . . . . . 27
- Quick instructions . . . . . 28

## R

- Recirculation mode . . . . . 8
- Repair service . . . . . 27

## S

- Safety . . . . . 23
- Safety precautions
  - Before using for the first time . . . . . 4
  - Children in the home . . . . . 5
  - Correct use . . . . . 5
  - Note on use . . . . . 6
- Saturation indicator . . . . . 14
- Service agreement . . . . . 27
- Service Centre . . . . . 27
- Spare parts . . . . . 21
  - Ordering . . . . . 27
- Switching off . . . . . 12
- Switching on . . . . . 12
- Symbols . . . . . 2

**T**

Technical data . . . . . 22  
Trouble-shooting . . . . . 19  
Type . . . . . 2

**U**

Use . . . . . 12

**V**

Validity . . . . . 2

## 11 Repair service



The TROUBLE-SHOOTING section will help you to carry out small repairs yourself, saving you the time and trouble of calling out a service technician and the cost that goes along with it.

Whether you contact us about a malfunction or an order, please always state the serial number (FN) and the model type of your appliance. Enter these details below and also on the service sticker which comes with the appliance. Stick it in a conspicuous place or in your telephone or address book.

FN

Appliance

You will also find the same details on the certificate of guarantee, the original sales invoice and the identification plate of the appliance.

- ▶ Remove metal grease filter.
  - The identification plate is located on the inside of the appliance.

If the appliance is not working properly, contact your nearest V-ZUG Ltd Service Centre using freephone 0800 850 850 and stand in close proximity to the appliance.

### Queries, orders, service agreement







For administrative and technical queries or problems, as well as for ordering spare parts and accessories, please contact our head office in Zug on telephone number +41 (0)41 767 67 67.

As regards the maintenance of all our products, when the warranty expires you have the option of taking out a service agreement. We will be happy to send you the necessary forms.

# Quick instructions

Please first read the safety precautions in the operating instructions!



-  Power level 1 on/off
-  Power level 2 on/off
-  Power level 3 on/off
-  Intensive level on/off
-  After-running time/Clean-Air function
-  Illumination on/off/dimmed
-  Grease filter saturation indicator

## V-ZUG Ltd

Industriestrasse 66, 6301 Zug  
Tel. +41 (0)41 767 67 67, Fax +41 (0)41 767 61 61  
vzug@vzug.ch, www.vzug.ch  
Service Centre: Tel. 0800 850 850



J991.013-2