

Freestanding microwave

Installation & User manual

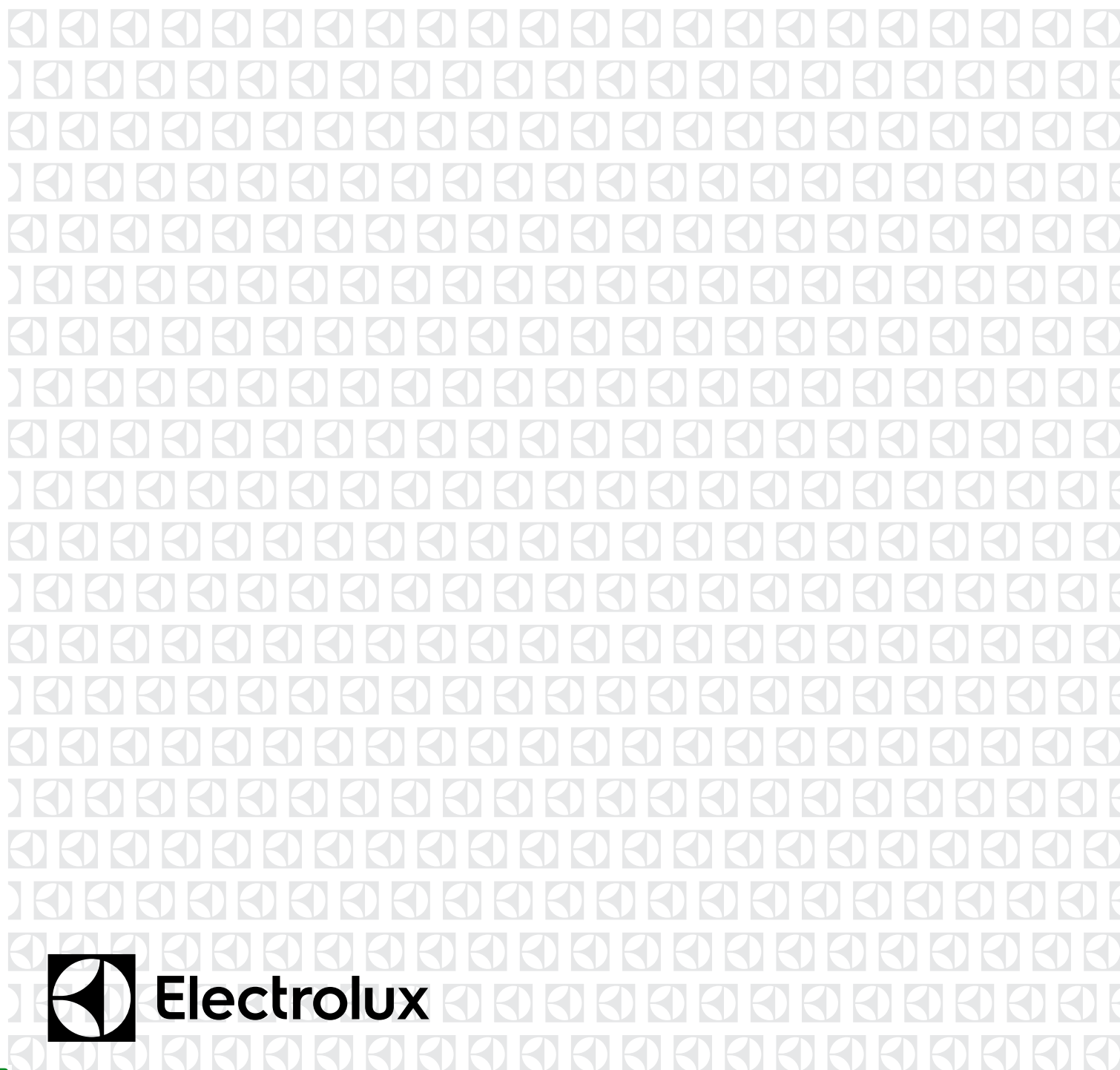

WE'RE THINKING OF YOU

Thank you for purchasing an Electrolux appliance. You've chosen a product that brings with it decades of professional experience and innovation. Ingenious and stylish, it has been designed with you in mind. So whenever you use it, you can be safe in the knowledge that you'll get great results every time. Welcome to Electrolux.

BEFORE USING YOUR APPLIANCE

Check for any damage or marks. If you find the appliance damaged or marked you must report it within 7 days to claim for damages under the manufacturer's warranty. This does not affect your statutory rights.

Before you use the appliance, we recommend that you read through the whole user manual which provides the description of the product and its functions. It is important that the product is installed correctly and that you read the safety instructions carefully to avoid misuse and hazards.

For future reference, please store this booklet in a safe place.

CONDITIONS OF USE

This appliance is intended to be used in household and similar applications such as:

- Staff kitchen areas in shops, offices and other working environments.
- Farm houses.
- By clients in hotels, motels and other residential type environments.
- Bed and breakfast type environments.

BEFORE YOU CALL

Please ensure you read the instruction manual fully before you call for service, or a full service fee could be applicable.

RECORD MODEL AND SERIAL NUMBER HERE:

Model: _____

Serial No: _____

IMPORTANT INFORMATION THAT MAY IMPACT YOUR MANUFACTURER'S WARRANTY

Adherence to the directions for use in this manual is extremely important for health and safety. Failure to strictly adhere to the requirements in this manual may result in personal injury, property damage and affect your ability to make a claim under the Electrolux manufacturer's warranty provided with your product. Products must be used, installed and operated in accordance with this manual. You may not be able to claim on the Electrolux manufacturer's warranty in the event that your product fault is due to failure to adhere to this manual.

CONTENTS

General warnings.....	3
Safety instructions	4
Product description	5
Accessories.....	5
Control panel.....	5
Before first use	6
Daily use.....	7
Automatic programmes	10
Using the accessories.....	11
Additional functions	11
Helpful hints and tips	12
Care and cleaning.....	13
Troubleshooting	13
Installation	14
Electrical Installation	15
Notes	16
Warranty.....	17

SYMBOLS



WARNING!

This symbol indicates information concerning your personal safety.



CAUTION!

This symbol indicates information on how to avoid damaging the appliance.



IMPORTANT!

This symbol indicates tips and information about use of the appliance.



ENVIRONMENT!

This symbol indicates tips and information about economical and ecological use of the appliance.

INFORMATION ON DISPOSAL FOR USERS



ENVIRONMENT!

- Most of the packaging materials are recyclable. Please dispose of these materials through your local recycling depot or by placing them in appropriate collection containers.
- If you wish to discard this product, please contact your local authorities and ask for the correct method of disposal.

GENERAL WARNINGS

Important safety instructions, read carefully and keep for future reference. Pass the user manual on to possible new owners of the appliance.

NOTE! You must read these warnings carefully before installing or using the appliance. If you need assistance, contact your Customer Care Department. The manufacturer will not accept liability, should these instructions or any other safety instructions incorporated in this book be ignored.

Children and vulnerable people safety.

WARNING!

Risk of suffocation, injury or permanent disability.

- This appliance is not intended for use by persons (including children) with reduced physical, sensory or mental capabilities, or lack of experience and knowledge, unless they have been given supervision or instruction concerning use of the appliance by a person responsible for their safety.
- Children should be supervised to ensure that they do not play with the appliance.
- Keep all packaging away from children.
- If the appliance has a child safety device, we recommend that you activate it if children are present.
- **WARNING:** Accessible parts may become hot during use. Young children should be kept away.

CAUTION!

Important safety instructions, read carefully and keep for future reference.

General safety

- Internally the appliance becomes hot when in operation. Do not touch the heating elements that are in the appliance. Always use oven gloves to remove or put in accessories or ovenware.
- Do not use a steam cleaner to clean the appliance.
- Before maintenance isolate the power supply.
- If the door or door seals are damaged, the appliance must not be operated until it has been repaired by a competent person.
- The appliance is not intended to be operated by means of an external timer or separate remote-control system.
- Only a competent person can carry out any service or repair operation that involves the removal of a cover which gives protection against exposure to microwave energy.
- Do not heat liquids and other foods in sealed containers. They are liable to explode.
- Only use utensils that are suitable for use in microwave ovens.

- When heating food in plastic or paper containers, keep an eye on the appliance due to the possibility of ignition.
- The appliance is intended for heating food and beverages. Drying of food or clothing and heating of warming pads, slippers, sponges, damp cloth and similar may lead to risk of injury, ignition or fire.
- If smoke is emitted, switch off or unplug the appliance and keep the door closed in order to stifle any flames.
- Microwave heating of beverages can result in delayed eruptive boiling. Care must be taken when handling the container.
- The contents of feeding bottles and baby food jars should be stirred or shaken and the temperature checked before consumption, in order to avoid burns.
- Eggs in their shell and whole hard-boiled eggs should not be heated in the appliance since they may explode, even after microwave heating has ended.
- The appliance should be cleaned regularly and any food deposits removed.
- Failure to maintain the appliance in a clean condition could lead to deterioration of the surface that could adversely affect the life of the appliance and possibly result in a hazardous situation.
- The temperature of accessible surfaces may be high when the appliance is operating.
- This appliance is designed for freestanding application. It must not be installed behind a decorative door or installed in an enclosed cupboard. Please follow the installation requirements in this manual.
- Do not use harsh abrasive cleaners or sharp metal scrapers to clean the glass door since they can scratch the surface, which may result in shattering of the glass.
- If the supply cord is damaged, it must be replaced by the manufacturer or an authorised service agent or similarly qualified persons in order to avoid a hazard.

CAUTION!

In order to avoid a hazard due to inadvertent resetting of the thermal cut-out, this appliance must not be supplied through an external switching device, such as a timer, or connected to a circuit that is regularly switched on and off by the utility.

WARNING!

Ensure that the appliance is switched off before replacing the lamp to avoid the possibility of electric shock.

SAFETY INSTRUCTIONS

Installation

WARNING!

Only a qualified person must install this appliance.

- Remove all the packaging.
- Do not install or use a damaged appliance.
- Obey the installation instructions supplied with the appliance.
- Always be careful when you move the appliance because it is heavy. Always wear safety gloves.
- Keep the minimum distance from the other appliances and units.

Electrical connection

WARNING!

Risk of fire and electrical shock.

- This appliance is supplied with a power cord and 10A power plug suitable for connection to standard 10A power socket. If a power socket needs to be installed, it must be done by a suitably qualified electrician.
- The appliance must be earthed.
- Make sure that the electrical information on the rating plate agrees with the power supply. If not, contact an electrician.
- Connect the mains plug to the mains socket only at the end of the installation. Make sure that there is access to the mains plug after the installation.
- Make sure not to cause damage to the mains plug and to the mains cable. Contact the Service Centre or an electrician to change a damaged mains cable.
- Do not pull the mains cable to disconnect the appliance. Always pull the mains plug.

Use

WARNING!

Risk of injury, burns or electric shock or explosion.

- Use this appliance in a household environment.
- Do not change the specification of this appliance.
- Make sure that the ventilation openings are not blocked.
- Do not leave the appliance unattended during operation.
- Do not apply pressure on the open door.
- Do not use the appliance as a work surface and do not use the cavity for storage purposes.
- Metallic containers for food and beverages are not allowed during microwave cooking.

Care and cleaning

WARNING!

Risk of injury, fire or damage to the appliance.

- Before maintenance, deactivate the appliance and disconnect the mains plug from the mains socket.
- Regularly clean the appliance to prevent the deterioration of the surface material.
- Do not allow food spills or cleaner residue to accumulate on door sealing surfaces.
- Remaining fat or food in the appliance can cause smoke/fire, particularly on the grill element.
- Clean the appliance with a moist soft cloth. Only use neutral detergents. Do not use abrasive products, abrasive cleaning pads, solvents or metal objects.
- Do not use a steam cleaner to clean this appliance.

Disposal

WARNING!

Risk of injury or suffocation.

- Disconnect the appliance from the mains supply.
- Cut off the mains cable and discard it.

PRODUCT DESCRIPTION

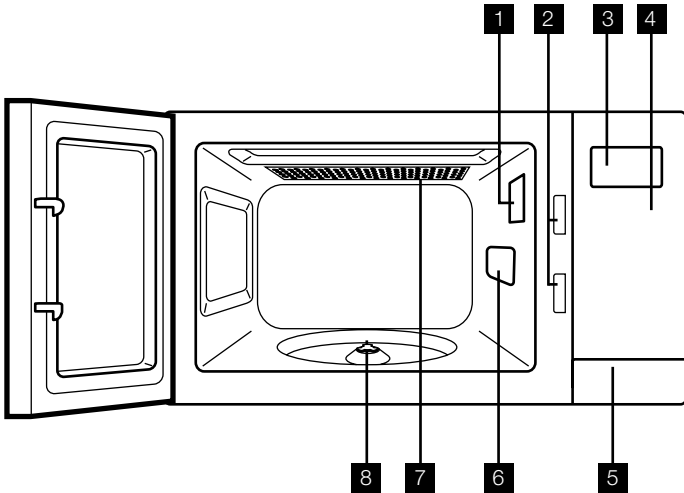

- | | |
|----------------------------------|--------------------------|
| 1 Lamp | 5 Door opener |
| 2 Safety Interlock system | 6 Waveguide cover |
| 3 Display | 7 Grill |
| 4 Control panel | 8 Turntable shaft |

ACCESSORIES

Turntable set

Glass cooking tray and roller guide.

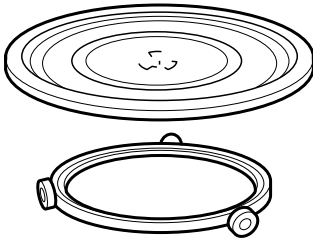

Always use the turntable set to prepare food in the appliance.

Grill rack

For grilling food and combi cooking.

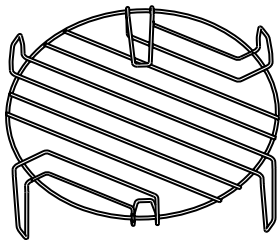



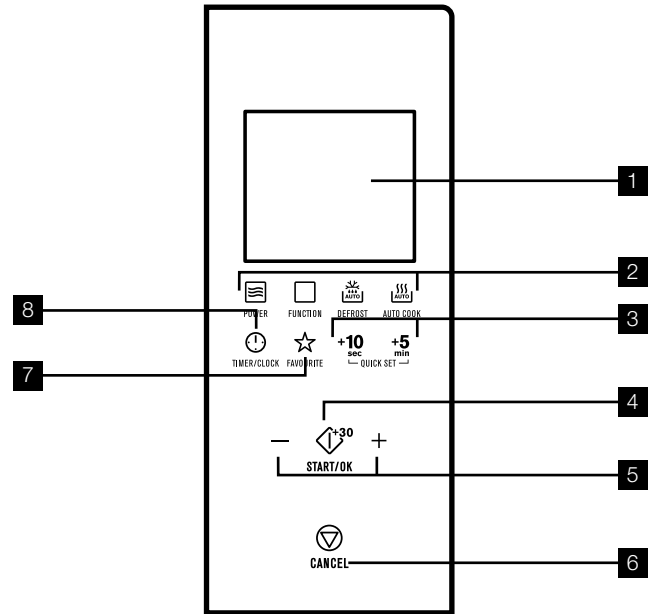

! WARNING!

The wire grill rack is not suitable for use on microwave only mode, it can be used on grill, convection and combi (includes short burst of microwave, which is ok) cooking modes only. Using this wire grill rack on microwave only mode may cause damage to the appliance.

CONTROL PANEL



Control panel

	Symbol	Function	Description
1	—	Display	Shows the settings and current time.
2		Function pads	To set the microwave / grill / convection / combi / auto defrost and auto cooking function.
3	+10 sec, +5 min	Time Set pads	To set the desired time.
4		Start / +30 sec	To start the appliance or increase the cooking time for 30 seconds at full power.
5	+ / —	Setting pads	To set the time, weight or temperature.
6		Cancel	To deactivate the appliance or delete the cooking settings.
7		Favourite	To save one favourite combination of cooking parameters.
8		Clock	To set the clock / reminder.

BEFORE FIRST USE



WARNING!

Refer to the safety chapters.

Initial cleaning

- Remove all packaging parts from the appliance.
- Clean the appliance before first use.



Refer to chapter "Care and cleaning".





Setting the time



When you connect the appliance to the electrical supply or after a power cut, the display shows 0:00.



You can set the time in a 24 hour clock system.

1. Press  twice.
2. To set the amount of hours press the setting pads.
3. Press  to confirm.
4. To set the amount of minutes press the setting pads.
5. Press  to confirm.
6. The display shows On. The clock is shown on the display when the appliance is not used. If you do not want the clock to be shown when the appliance is in standby mode press **+** or **-** and set **OFF**.
7. Press  to confirm.





DAILY USE



WARNING!

Refer to the safety chapters.

Activating and deactivating the appliance

1. Press the pad with the function you want to activate.
2. For functions which include microwave press  to set the power level.
3. To set the time press the - and + setting pads.
4. Press  to activate the appliance.
5. To deactivate the appliance you can:
 - wait until the appliance deactivates automatically when the time comes to an end and an acoustic signal sounds. The display shows End.
 - open the door. The appliance stops automatically. Close the door and press  to continue cooking. Use this option to inspect the food.
 - Press .



CAUTION!

Do not operate the appliance without food inside, it may cause damage to the appliance.

General information about using the appliance

General:

- After completing a microwave cooking cycle, let the food stand for some minutes.
- Remove the aluminium foil packaging, metal containers, etc before you prepare the food.

Cooking:

- If possible, cook food covered with material suitable for use in the microwave. Only cook food without a cover if you want to keep it crusty.
- Do not overcook the dishes by setting the power and time too high. The food can dry out, burn or catch fire.
- Do not use the appliance to cook eggs or snails in their shells, because they can explode. With fried eggs, pierce the yolks first.
- Prick food with "skin" or "peel", such as potatoes, tomatoes, sausages, with a fork several times before cooking so that the food does not explode.
- For chilled or frozen food, set a longer cooking time at a lower power level.
- Dishes which contain sauce must be stirred from time to time.
- Vegetables that have a firm structure, such as carrots, peas or cauliflower, must be cooked in water.
- Turn larger pieces after half of the cooking time.
- If possible, cut vegetables into similar sized pieces.
- Use flat, wide dishes.

- Do not use cookware made of porcelain, ceramic or earthenware with small holes, e.g. on handles or unglazed bottoms. Moisture going into the holes can cause the cookware to crack when it is heated.
- The glass cooking tray is a work space for heating food or liquids. It is necessary for the operation of the microwave. All food and cookware must be placed on the glass cooking tray.

Defrosting meat, poultry, fish:

- Put the frozen, unwrapped food on a small upturned plate with a container below it so that the defrosting liquid collects in the container.
- Turn the food after half of the defrosting time. If possible, divide and then remove the pieces that started to defrost.

Defrosting butter, portions of gâteau, quark:

- Do not fully defrost the food in the appliance, but let it defrost at room temperature. This gives a more even result. Fully remove all metal or aluminium packaging before defrosting.

Defrosting fruit, vegetables:

- Do not fully defrost fruit and vegetables, which are to be further prepared while raw, in the appliance. Let them defrost at room temperature.
- You can use a higher microwave power to cook fruit and vegetables without defrosting them first.

Ready meals:

- You can prepare ready meals in the appliance only if their packaging is suitable for microwave use.
- You must follow the manufacturer's instructions printed on the packaging (e.g. remove the metal cover and pierce the plastic film).

DAILY USE (CONTINUED)

Suitable cookware and materials

Cookware / Material	Microwave			Grilling/ Convection
	Defrosting	Heating	Cooking	
Ovenproof glass and porcelain (with no metal components, e.g. Pyrex, heat-proof glass)	■	■	■	■
Non-ovenproof glass and porcelain ¹⁾	■	--	--	--
Glass and glass ceramic made of ovenproof / frost-proof material (e.g. Arcoflam), grill shelf	■	■	■	■
Ceramic ²⁾ , earthenware ²⁾	■	■	■	--
Heat-resistant plastic up to 200°C ³⁾	■	■	■	--
Cardboard, paper	■	--	--	--
Clingfilm	■	--	--	--
Roasting film with microwave safe closure ³⁾	■	■	■	--
Roasting dishes made of metal, e.g. enamel, cast iron	--	--	--	■
Baking tins, black lacquer or silicon coated ³⁾	--	--	--	■
Baking tray	--	--	--	■
Browning cookware, e.g. Crisp pan or Crunch plate	--	■	■	--
Ready meals in packaging ³⁾	■	■	■	■

1) With no silver, gold, platinum or metal plating / decorations.

2) Without quartz or metal components, or glazes which contain metals.

3) You must follow the manufacturer's instructions about the maximum temperatures.

■ suitable













-- not suitable

DAILY USE (CONTINUED)

Power setting table

Press 	Power setting	Approximate percentage of power
1 time	900 Watt	100%
2 times	700 Watt	77%
3 times	500 Watt	55%
4 times	300 Watt	33%
5 times	100 Watt	17%

Other functions



Press 	Display	Function mode
Grilling		
1 time		Full Grill
Combi Cooking		
2 times	 	Microwave, Convection
3 times	 	Microwave, Grill
4 times	 	Convection, Grill
5 times	  	Microwave, Convection, Grill
Convection Cooking		
6 times		Convection cooking at set temperature

Quick Start

- Press  to activate the appliance for 30 seconds at full function power. The cooking time increases by 30 seconds with each additional press of the button. The maximum cooking time is 95 minutes.

Defrosting

Weight and time defrosting

- Repeatedly press  to set the desired defrosting function (either weight or time).
- Press the Setting pads to input the desired weight or time.
- Press  to confirm and start the appliance.
- For weight defrosting the display shows the set defrosting time.

 For weight defrosting the time is set automatically. When using the time defrost function, time should be reduced for food that is left out to thaw for more than 20 minutes.



 To activate weight defrosting you must use more than 100g of food and less than 2000g.

 To defrost less than 200g of food place it on the edge of the turntable.

Convection Cooking

For better results, preheat the appliance to the right temperature before inserting the food.



Convection cooking with preheating function:

- Press  six times to set to convection cooking.
- Press the “+” or “-” to set the temperature.
- Press  to confirm and start the appliance.

 When the temperature is reached an acoustic signal sounds.

 You can use the Kitchen Timer as a time reminder.

Grilling or Combi Cooking

- Repeatedly press  to set the Grilling or Combi Cooking function.
- Press the “+” or “-” to set the cooking time.
- Press  to confirm and start the appliance.

An acoustic signal sounds after half of the cooking time passes. You can turn over the food.

AUTOMATIC PROGRAMMES





WARNING!

Refer to the safety chapters.

Auto Cooking

You can use Auto Cooking function to easily cook food.

1. Repeatedly press  to set the desired menu.
2. Press the Setting pads to input the weight.
3. To change the set menu for a different one press .
4. Press  to confirm and start the appliance.

Favourite

Setting the programmes

1. Set the function and parameters you want to save.
2. Press  and hold for 2 seconds.
3. An acoustic signal sounds after the settings are saved.

Using the programmes

1. Press .
2. To start the appliance press .



You can save only one Favourite setting.

Display	Menu	Weight
	Auto Reheat	150g
		250g
		350g
		450g
		600g
	Beverage	1 cup
	Pizza	200g
		300g
		400g
	Popcorn	50g
		100g
	Chicken	500g
		750g
		1kg
		1.2kg
	Meat	150g
		300g
		450g
		600g
	Potato	230g
		460g
		690g
	Vegetable	150g
		350g
		500g
	Fish	150g
		250g
		350g
		450g
		650g
	Pasta	50g (add 450ml of water)
		100g (add 800ml of water)
		150g (add 1200ml of water)

USING THE ACCESSORIES

! WARNING!

Refer to the safety chapters.

! CAUTION!

Do not cook food without the turntable set. Use only the turntable set provided with the appliance.



Never cook food directly on the glass cooking tray.

Inserting the turntable set

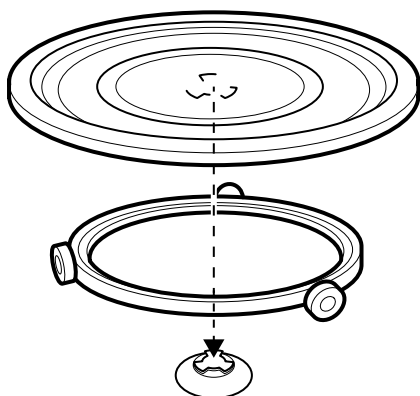

1. Place the roller guide around the turntable shaft.
2. Before first use remove the tape from the centre of the turntable shaft.
3. Place the glass cooking tray on the roller guide.

Inserting the grill rack

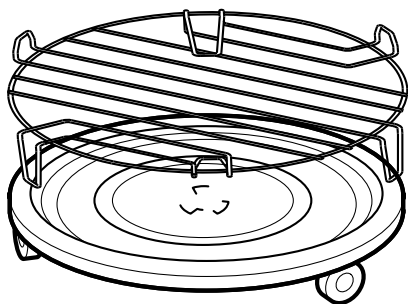

Place the grill rack on the turntable set.

! WARNING!

The wire grill rack is not suitable for use on microwave only mode, it can be used on grill, convection and combi (includes short burst of microwave, which is ok) cooking modes only. Using this wire grill rack on microwave only mode may cause damage to the appliance.

ADDITIONAL FUNCTIONS

Kitchen Timer

1. Press
2. Press the Setting pads to set the time.
3. The Kitchen Timer activates automatically after a few seconds.

When the set time is reached, an acoustic signal sounds. You can set maximum 95 minutes.

i When a function is running and the timer is set you can see the time left or clock if required. Pressing 0 will toggle between function display, timer display or clock display. The timer display will revert back to function after approx. 5 seconds. The clock display will revert back to function after approx. 10 seconds.

i Timer still works when you open the door or pause the appliance. Press to cancel.

Child Safety Lock

The Child Safety Lock prevents an accidental operation of the appliance.

To activate or deactivate the Child Safety Lock press and hold for 3 seconds, until an acoustic signal sounds.

When the Child Safety Lock is on, the display shows .

HELPFUL HINTS AND TIPS

Power setting table

Problem	Remedy
You cannot find details for the amount of food prepared.	Look for a similar food. Increase or shorten the length of the cooking times according to the following rule: Double the amount = almost double the time, Half the amount = half the time
The food got too dry.	Set shorter cooking time or select lower microwave power.
The food is not defrosted, hot or cooked after the time came to an end.	Set longer cooking time or set higher power. Note that large dishes need longer time.
After the cooking time comes to an end, the food is overheated at the edge but is still not ready in the middle.	Next time set a lower power and a longer time. Stir liquids halfway through, e.g. soup.

To get better results for rice use a flat, wide dish.

Defrosting

Always defrost roast with the fat side down. Do not defrost covered meat because this may cause cooking instead of defrosting. Always defrost whole poultry breast side down.

Cooking

Always remove chilled meat and poultry from the refrigerator at least 30 minutes before cooking. Let the meat, poultry, fish and vegetables stay covered after cooking.

Brush a little oil or melted butter over the fish. Add 30-45ml of cold water for every 250g of vegetables. Cut the fresh vegetables into even size pieces before cooking. Cook all vegetables with a cover on the container.

Reheating

When you reheat packed ready meals always follow the instructions written on the packaging.

Grilling

Grill flat food items in the middle of the grill rack. Turn the food over halfway through the set time and continue grilling.

Convection Cooking

You can cook food as in a traditional oven. No microwaves are used.

Combi Cooking

Use the Combi Cooking to keep the crispness of certain foods. At the half of the cooking time, turn over the foods then continue. There are 4 modes for Combi Cooking. Each mode combines the microwave, grill and convection functions at different time periods and power levels.

CARE AND CLEANING



WARNING!

Refer to the safety chapters.

Notes on cleaning:

- To clean front panel fingerprint-resistant stainless steel simply wipe with a soft cloth using warm water and a mild detergent. DO NOT use stainless steel cleaners, abrasive cleaners or harsh solvents.
- Clean the appliance interior after each use. Then you can remove dirt more easily and it does not burn on.
- Clean stubborn dirt with a special cleaner.
- Clean all accessories regularly and let them dry. Use a soft cloth with warm water and a cleaning agent.
- To soften hard to remove remains, boil a glass of water at full microwave power for 2 to 3 minutes.
- To remove odours, mix a glass of water with 2 tsp of lemon juice and boil at full microwave power for 5 minutes.

TROUBLESHOOTING



WARNING!

Refer to the safety chapters.

Problem	Possible cause	Remedy
The appliance does not operate.	The appliance is deactivated.	Activate the appliance.
	The appliance is not plugged in.	Plug in the appliance.
	The fuse in the fuse box is blown.	Check the fuse. If the fuse blows more than one time, contact a qualified electrician.
	The door is not closed properly.	Make sure that nothing blocks the door.
The lamp does not operate.	The lamp is defective.	The lamp has to be replaced. Contact the customer service centre.
The display shows [---].	The Child Safety Lock is active.	Deactivate the Child Safety Lock. Hold the Cancel button for 3 seconds.
There is sparking in the cavity.	There are metal dishes or dishes with metal trim.	Remove the dish from the appliance.
	There are metal skewers or aluminium foil that touches the interior walls.	Make sure that the skewers and foil does not touch the interior walls.
The turntable set makes scratching or grinding noise or does not rotate smoothly.	There is an object or dirt below the glass cooking tray.	Clean the area below the glass cooking tray including rollers. Check turntable roller assembly and glass are installed correctly.
The appliance stops operating without a clear reason.	There is a malfunction.	Check ventilation of the unit is not obstructed. If this situation repeats with correct installation call the customer service centre.
Microwave runs cooking cycle but food does not heat up.	Internal self-resetting thermostat has activated. The microwave is fitted with a thermostat to protect internal components from overheating.	Once the thermostat's temperature has reduced the unit should function normally. Wait 5 minutes then try the appliance again.
Steam accumulating on microwave oven door or leaking from vents.	Cooking foods with a high moisture content will always produce steam.	This is a normal part of the cooking process.
Smoke during cooking process.	Fat accumulated on cavity grill element.	Ensure inside of unit is cleaned regularly.

If you cannot find a solution to the problem yourself, contact your dealer or the customer service centre.

The necessary data for the customer service centre is on the rating plate on the appliance.

We recommend that you write the data here:

Model (M)

.....

Product number (PNC)

.....

Serial number (S.N.)

.....

INSTALLATION OF EMF2529DSD

! CAUTION!

Do not block the air vents. If you do that, the appliance can overheat.

! CAUTION!

Do not connect the appliance to adapters or extension leads. This can cause overloading and risk of fire.

- Put the appliance far away from steam, hot air and water splashes.
- If the appliance is stored/ transported at sub-zero temperatures, do not activate it immediately after installation. Allow at least two hours for it to be brought up to room temperature before turning on the unit.

Installation - Freestanding model EMF2529DSD

- Remove all packing material and any promotional material from the microwave oven.
- Examine the oven for any damage such as dents or a broken door. Do not install if the oven is damaged. Call the service centre.
- Remove the protective film on the oven cabinet surface. Do not remove the light brown Mica cover that is attached to the right-hand side of the oven cavity to protect the magnetron.
- Do not leave the packing material so that small children can play with it. This can be hazardous.
- Select a flat, level surface that provides enough open space for the intake and outlet vents and that is strong enough to bear the weight of the oven. A minimum clearance of 7.5cm is required between the oven and any adjacent walls. Leave a minimum clearance 30cm above the oven.

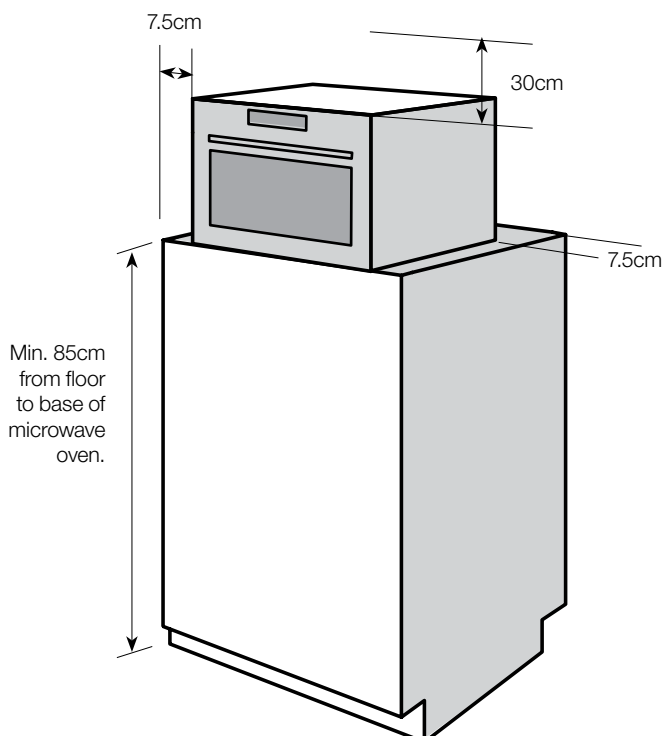

Blocking the intake or outlet vents can damage the oven. If air vents are blocked during operation, the oven may overheat, and this may lead to malfunctioning. Hot air escapes from the vents, so be sure not to obstruct it or let curtains come between the oven and the rear wall.

NOTE: It is recommended to have greater than 7.5cm clearance on at least one of the sides to improve product performance and operation.

- The oven should be placed in a stable position to avoid the possibility of causing vibration or noise.
- Do not remove the legs from the bottom of the oven.
- This oven should only be installed freestanding; not built-in or in a cabinet.
- Keep the oven away from heat and water. Exposure to heat and water can lower the efficiency and lead to malfunctioning.
- Place the oven as far away from radios and TV as possible. Operation of the oven may cause interference to your radio or TV reception.
- When there is interference, it may be reduced or eliminated by taking the following measures:
 - Clean door and sealing surface of the microwave oven.
 - Reorient the receiving antenna of the radio and/or television.
 - Move the microwave oven away from the receiver.
 - Plug the microwave oven into a different outlet so that microwave oven and receiver are on different branch circuits.
- Be sure the voltage and frequency where you connect the microwave oven is the same as specified on the rating plate on the microwave oven. If the microwave oven is connected to the socket via an extension cord, make sure the cord is earthed.

! WARNING!

If installed near or over a heat source, the microwave oven could be damaged.

! WARNING!

This microwave oven must not be used on a non-earth protected power supply. Contact an electrician if you are uncertain regarding electrical connection of the oven or provision of earth protection of the supply.

! WARNING!

If the power cord is damaged, it must be replaced by the manufacturer, its service agent or similarly qualified persons in order to avoid a hazard.

ELECTRICAL INSTALLATION



WARNING!

Only a qualified person must do the electrical installation.



The manufacturer is not responsible if you do not follow the safety precautions from the chapter “Safety Instructions”.

This appliance is supplied with a main cable and main plug.



WARNING!

The microwave oven is fitted with a plug and must be only connected to a properly installed, earthed socket. In accordance with the appropriate regulations, the socket must only be installed and the connecting cable must only be replaced by a qualified electrician. If the plug is no longer accessible following installation an all-pole isolating switch must be present on the installation side with a contact gap of at least 3mm.



FOR SALES IN AUSTRALIA AND NEW ZEALAND
APPLIANCE: ELECTROLUX SOLO MICROWAVE
AND MICROWAVE WITH GRILL

This document sets out the terms and conditions of the product warranties for Electrolux Appliances. It is an important document. Please keep it with your proof of purchase documents in a safe place for future reference should there be a manufacturing defect in your Appliance. This warranty is in addition to other rights you may have under the Australian Consumer Law.

1. In this warranty:

- (a) 'ACL' or 'Australian Consumer Law' means Schedule 2 to the Competition and Consumer Act 2010;
 - (b) 'Appliance' means any Electrolux product purchased by you and accompanied by this document;
 - (c) 'ASC' means Electrolux's authorised serviced centres;
 - (d) 'Electrolux' is the brand controlled by Electrolux Home Products Pty Ltd of 163 O'Riordan Street, Mascot NSW 2020, ABN 51 004 762 341 in respect of Appliances purchased in Australia and Electrolux (NZ) Limited (collectively "Electrolux") of 3-5 Niall Burgess Road, Mount Wellington, in respect of Appliances purchased in New Zealand;
 - (e) 'Warranty Period' means the period specified in clause 3 of this warranty;
 - (f) 'you' means the purchaser of the Appliance not having purchased the Appliance for re-sale, and 'your' has a corresponding meaning.
- 2. Application:** This warranty only applies to new Appliances, purchased and used in Australia or New Zealand and is in addition to (and does not exclude, restrict, or modify in any way) other rights and remedies under a law to which the Appliances or services relate, including any non-excludable statutory guarantees in Australia and New Zealand.
- 3. Warranty Period:** Subject to these terms and conditions, this warranty continues for in Australia for a period of 12 months and in New Zealand for a period of 12 months, following the date of original purchase of the Appliance.
- 4. Repair or replace warranty:** During the Warranty Period Electrolux or its ASC will not service the Appliance. If the Appliance is defective, you should return the Appliance to the place of purchase for a replacement. You agree that any replaced Appliances or parts become the property of Electrolux.
- 5. Travel and transportation costs:** Subject to clause 7, Electrolux will bear the reasonable cost of transportation, travel and delivery of the Appliance to and from Electrolux or its ASC.
- 6. Proof of purchase** is required before you can make a claim under this warranty.
- 7. Exclusions:** You may not make a claim under this warranty unless the defect claimed is due to faulty or defective parts or workmanship. This warranty does not cover:
- (a) light globes, batteries, filters or similar perishable parts;
 - (b) parts and Appliances not supplied by Electrolux;
 - (c) cosmetic damage which does not affect the operation of the Appliance;
 - (d) damage to the Appliance caused by:
 - (i) negligence or accident;
 - (ii) misuse or abuse, including failure to properly maintain or service;

- (iii) improper, negligent or faulty servicing or repair works done by anyone other than an Electrolux authorised repairer or ASC;
- (iv) normal wear and tear;
- (v) power surges, electrical storm damage or incorrect power supply;
- (vi) incomplete or improper installation;
- (vii) incorrect, improper or inappropriate operation;
- (viii) insect or vermin infestation;
- (ix) failure to comply with any additional instructions supplied with the Appliance;

In addition, Electrolux is not liable under this warranty if:

- (a) the Appliance has been, or Electrolux reasonably believes that the Appliance has been, used for purposes other than those for which the Appliance was intended, including where the Appliance has been used for any non-domestic purpose;
- (b) the Appliance is modified without authority from Electrolux in writing;
- (c) the Appliance's serial number or warranty seal has been removed or defaced.

8. How to claim under this warranty: To enquire about claiming under this warranty, please follow these steps:

- (a) carefully check the operating instructions, user manual and the terms of this warranty;
- (b) have the model and serial number of the Appliance available;
- (c) have the proof of purchase (e.g. an invoice) available;
- (d) telephone the numbers shown below.

9. Australia: For Appliances and services provided by Electrolux in Australia: Electrolux goods come with guarantees that cannot be excluded under the Australian Consumer Law. You are entitled to a replacement or refund for a major failure and for compensation for any other reasonably foreseeable loss or damage. You are also entitled to have the Appliance repaired or replaced if the Appliance fails to be of acceptable quality and the failure does not amount to a major failure. 'Acceptable quality' and 'major failure' have the same meaning as referred to in the ACL.

10. New Zealand: For Appliances and services provided by Electrolux in New Zealand, the Appliances come with a guarantee by Electrolux pursuant to the provisions of the Consumer Guarantees Act, the Sale of Goods Act and the Fair Trading Act. Where the Appliance was purchased in New Zealand for commercial purposes the Consumer Guarantee Act does not apply.

11. Confidentiality: You accept that if you make a warranty claim, Electrolux and its agents including ASC may exchange information in relation to you to enable Electrolux to meet its obligations under this warranty. For more information on how we handle your personal information, see our privacy policy at www.electrolux.com.au/other/privacy/ and www.electrolux.co.nz/other/privacy/

Important Notice

Before calling for service, please ensure that the steps listed in clause 8 above have been followed.

<p>FOR SERVICE or to find the address of your nearest authorised service centre in Australia PLEASE CALL 13 13 49 For the cost of a local call (Australia only)</p>	<p>AUSTRALIA ELECTROLUX HOME PRODUCTS 163 O'Riordan Street, Mascot NSW 2020 electrolux.com.au</p>	<p>FOR SPARE PARTS or to find the address of your nearest spare parts centre in Australia PLEASE CALL 13 13 50 For the cost of a local call (Australia only)</p>
<p>FOR SERVICE or to find the address of your nearest authorised service centre in New Zealand PLEASE CALL 0800 10 66 10 (New Zealand only)</p>	<p>NEW ZEALAND ELECTROLUX (NZ) Limited 3-5 Niall Burgess Road, Mount Wellington electrolux.co.nz</p>	<p>FOR SPARE PARTS or to find the address of your nearest spare parts centre in New Zealand PLEASE CALL 0800 10 66 20 (New Zealand only)</p>

Electrolux Home Products Australia

telephone: 1300 363 640
fax: 1800 350 067
email: customercare@electrolux.com.au
web: electrolux.com.au

shop.electrolux.com.au



Electrolux Home Products New Zealand

telephone: 0800 436 245
fax: 0800 225 088
email: customercare@electrolux.co.nz
web: electrolux.co.nz



To add a touch of professional inspiration to your home, visit electrolux.com.au or electrolux.co.nz

electrolux.com.au



or electrolux.co.nz

