

X10 USER MANUAL



Thank you for purchasing the X10 speaker. You can use it with pads, phones and pods, as well as many other types of smartphone, to stream music. In order to get the best user trial when using the speaker, please read this manual first before using.

What's in the box

- 1* X10 Speaker
- 1* Type-C charging cable
- 1* User manual

Please read the safety advice carefully and keep it for future reference.

Safety Instructions



1. This logo means that no naked flames, such as a candle can be placed on or near the device.



2. The electrical and electronic equipment are part of a separate collection. Do not throw electrical or electronic equipment away with unsorted municipal waste, but ensure that it is collected separately. Collection systems and locations (sorting centres, rubbish dumps) are provided for your by local councils and retailers. By entrusting your end-of-life product to the proper recycling process, you can helping to protect the environment and your health.

3. Use this device in temperate climates only.

4. This device may be used by children aged 8 years or older any by those with reduced physical, sensory or mental abilities, or those lacking experience or knowledge, provided they are correctly supervised, or if the instructions related to the use of the device have been adequately given and if the risks involved have been understood. Children must not play with this device. Children should not clean or maintain the device without supervision.

5. The electrical socket must remain easily accessible if it serves as the means of disconnection.

6. Always unplug the device before cleaning it.

7. Clean the device with a soft dry cloth only. Never use solvents.

8. Attention should be drawn to the environmental aspects of battery disposal.

9. The battery (batteries or battery pack) shall not be exposed to excessive heat such as sunshine , fire or the like.

10. Use the apparatus in moderate climate only.

Specifications

Bluetooth Version	V5.3
Output	15W
Built-in battery	Li-ion 3.7V 2000mAh
SNR	≥84db
Frequency	80HZ-20KHZ
Wireless Working Frequency	2.402-2.480GHZ
Wireless Transmission Distance	Up to 10M
Charging Time	3-4hours
Playback Time	Up to 12hours
Charging current	DC 5V/1A
Size	W88mm*H105mm*D91mm

Product Diagram

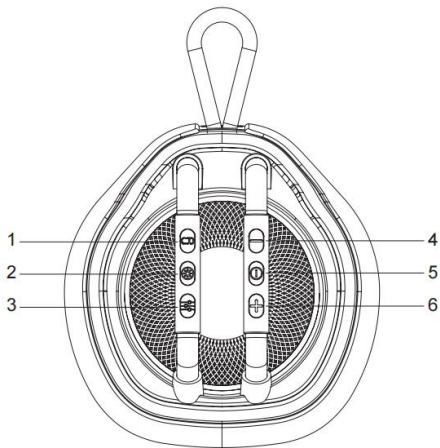

1. Broadcast button
2. RGB light button
3. Audio effects button
4. Volume Down / Previous Track
5. Power on/off - Play / Pause
6. Volume up / Next Track

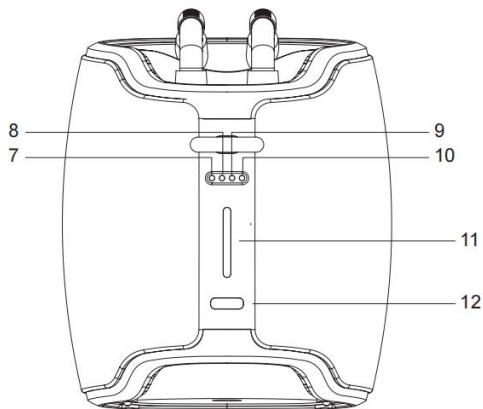



7. Left channel indicator
8. Bluetooth indicator
9. Broadcast indicator
10. Right channel indicator
11. Battery indicator
12. Type-c port

Charging your speaker

1. Use the type-C power cord in the accessories to connect the DC 5V charger and speaker for charging.
2. The white power LED will be flash to indicate that the unit is charging. then will on lighting when fully charged.

Note: A full charge takes approximately 3 hours.

Power On / Power Off

1. Power on: Press and hold the  button for 2 seconds to power on the speaker. The battery indicator keep lighting, whilst Bluetooth indicator will flash with blue.
2. Power off: Press and hold the  button for 2 seconds to power off the speaker.



Pairing Bluetooth Devices with Your Speaker

The speaker will not automatically connect to a new device when power on. In order to pair your Bluetooth audio device with your Bluetooth Speaker for the first time, follow the steps below:

1. Power on your speaker, the working state LED will flash in blue.
2. Enable Bluetooth on your devices (phone or audio device). Refer to the manufacture's instructions for details.
3. Search for Bluetooth devices and select "X10". If required, enter the password "0000" to confirm and complete the pairing process.
4. The speaker will beep when the devices are paired. And the working state LED will keep lighting with blue.



Note: The speaker will power off automatically if no connection within 10 minutes.

Bluetooth Music Playback

1. Open the music player and select a song to play. Press the  button to pause / play the music.
2. Brief click the  button to increase the volume or long press to skip to the next song.

3. Briefly click the  button to decrease the volume or long press to skip to the previous song.

Broadcast Function

1. Turn on all X10 speakers and make sure they are not connected with any devices.
2. Turn on Bluetooth on your phone or other device, select " X10 " to connect and choose this speaker as master.
3. Briefly click the  button on the master speaker, the alarm sounded, and the broadcast indicator light remained illuminated in green, then double-click the  button of other speaker one by one, they will automatically connect to each other directly.

2.0 Audio effects

As successful broadcast pairing, briefly press the left X10  button for 1 seconds to enter the left channel mode, with the white indicator illuminating.

Press and hold the right X10  button for 1 second to enter the right channel mode, with the red indicator illuminating.

Light theme

Briefly click the  button when playing the music, the light theme can be changed. There are three light themes: Rhythm / Gradient / Breath / no light

Reset

Press and hold the  button 2 seconds to clear pairing records.

Troubleshooting

Q: My speaker will not switch on.

A: Please recharge it and make sure it has enough power. Plug the unit into a charger and see if the power LED indicator turns on.

Q: Why can't I pair this speaker with other Bluetooth devices?

A: Please check the following:

Your Bluetooth device supports the A2DP profile.

The speaker and your device are next to each other (within 1m).

The speaker has connected one Bluetooth device, if yes, you can press the button to clear and pair a new device.

FCC Warning:

This equipment has been tested and found to comply with the limits for a Class B digital device, pursuant to part 15 of the FCC Rules. These limits are designed to provide reasonable protection against harmful interference in a residential installation. This equipment generates, uses and can radiate radio frequency energy and, if not installed and used in accordance with the instructions, may cause harmful interference to radio communications. However, there is no guarantee that interference will not occur in a particular installation. If this equipment does cause harmful interference to radio or television reception, which can be determined by turning the equipment off and on, the user is encouraged to try to correct the interference by one or more of the following measures:

- Reorient or relocate the receiving antenna.
- Increase the separation between the equipment and receiver.
- Connect the equipment into an outlet on a circuit different from that to which the receiver is connected.
- Consult the dealer or an experienced radio/TV technician for help.

Caution: Any changes or modifications to this device not explicitly approved by manufacturer could void your authority to operate this equipment.

This device complies with part 15 of the FCC Rules. Operation is subject to the following two conditions:

(1) This device may not cause harmful interference, and (2) this device must accept any interference received, including interference that may cause undesired operation.

This equipment complies with FCC radiation exposure limits set forth for an uncontrolled environment. This equipment should be installed and operated with minimum distance 0cm between the radiator and your body.