

Portable Air Conditioner

User's manual

EN



SENCOR®

SAC MT9012CH

Prior to using this appliance, please read the user's manual thoroughly, even in cases, when one has already familiarised themselves with previous use of similar types of appliances. Use the appliance only as described in this manual. Keep this manual for later use.

Save the original shipping box, packaging material, purchase receipt and warranty card for the duration of the warranty. In the event of shipping, pack the appliance using the original packaging materials only.

EN-1

CONTENTS

| | |
|--|----|
| IMPORTANT SAFETY INSTRUCTIONS..... | 3 |
| DESCRIPTION OF THE PORTABLE AIR CONDITIONER..... | 5 |
| DESCRIPTION OF THE ACCESSORIES..... | 6 |
| DESCRIPTION OF THE CONTROL PANEL..... | 7 |
| DESCRIPTION OF THE REMOTE CONTROL..... | 8 |
| INSTALLING THE PORTABLE AIR CONDITIONER..... | 10 |
| ENERGY SAVING TIPS..... | 12 |
| CONDENSATE DRAIN OUTLET..... | 12 |
| HOW TO CONTROL THE PORTABLE AIR CONDITIONER..... | 13 |
| SELF-DIAGNOSIS..... | 17 |
| TROUBLESHOOTING TABLE..... | 18 |
| MAINTENANCE AND CLEANING..... | 19 |
| TECHNICAL SPECIFICATIONS..... | 20 |
| INSTRUCTIONS AND INFORMATION REGARDING THE DISPOSAL OF USED PACKAGING..... | 21 |
| DISPOSAL OF USED BATTERIES..... | 21 |
| DISPOSAL OF USED ELECTRICAL AND ELECTRONIC EQUIPMENT..... | 21 |

IMPORTANT SAFETY INSTRUCTIONS

- This appliance may be used by children 8 years of age and older and by persons with physical or mental impairments or by inexperienced persons if they are properly supervised or have been informed about how to use of the product in a safe manner and understand the potential dangers.
- Do not allow children to play with the appliance. Cleaning and maintenance must not be performed by unsupervised children.

IMPORTANT SAFETY INSTRUCTIONS READ CAREFULLY AND STORE THEM FOR FUTURE USE

- This appliance is designed for use in households, offices and similar types of areas.
- Do not use the appliance in very humid rooms such as laundries or bathrooms, in areas where flammable chemicals are stored, in industrial surroundings or outdoors!
- Do not place the appliance in the vicinity of an open flame or appliances that are sources of heat.
- Always install the appliance on an even, dry and stable surface.
- The appliance is equipped with travel wheels so pay extra attention when handling it so that it does not fall down stairs or travel down from sloped areas. If necessary secure the wheels using the supplied stoppers.
- Before connecting the appliance to a power socket, check that the technical details on the appliance's rating label match the electrical voltage in the socket.
- Connect the appliance only to a grounded power socket. Do not use an extension cable to connect the appliance to a power socket.
- The power socket to which you connect the appliance must be freely accessible so that it is possible to quickly disconnect it from the power source if necessary.
- Do not touch the appliance that is connected to a power socket with wet hands.
- Do not spray the appliance with water or any other liquid or submerge it in water or any another liquid.
- Do not cover or insert anything into the air inlet or air outlet openings. Otherwise this could damage the appliance.
- During operation there needs to be sufficient space for air circulation of at least 30 cm on all sides of the appliance.
- Do not expose yourself to a cold air current for a long time. This could have a negative effect on your health.
- To turn the appliance on or off, always use the appropriate buttons on the control panel or the remote control. Do not turn off the appliance by disconnecting the power cord from the power socket.
- Always turn off the appliance and disconnect it from the power socket before installing or removing accessories, if you will not be using it or before cleaning it.
- Do not attempt to remove the outer case of the appliance.
- Do not disconnect the appliance from the power socket by pulling on the power cord. This could damage the power cord or the power socket. Disconnect the cord from the power socket by gently pulling out the plug of the power cord.
- It is forbidden to use the appliance if it has a damaged power cord or plug. If the power cord is damaged, have it replaced at a professional service centre.
- Store the appliance in a vertical position. It may be transported in a vertical position or tilted to one side. If you have already used the appliance, first check that all the condensate has been drained. If you have transported the appliance, wait at least 1 hour before putting it into operation.
- Do not use the appliance if it is not working correctly, if it has been damaged or has been submerged in water. To avoid the danger of injury by electrical shock, do not repair the appliance yourself or make any adjustments to it. Have all repairs or adjustments of the appliance performed at an authorised service centre. Tampering with the appliance during the warranty period may void the warranty policy.

Portable Air Conditioner

SAC MT9012CH

EN

DESCRIPTION OF THE PORTABLE AIR CONDITIONER

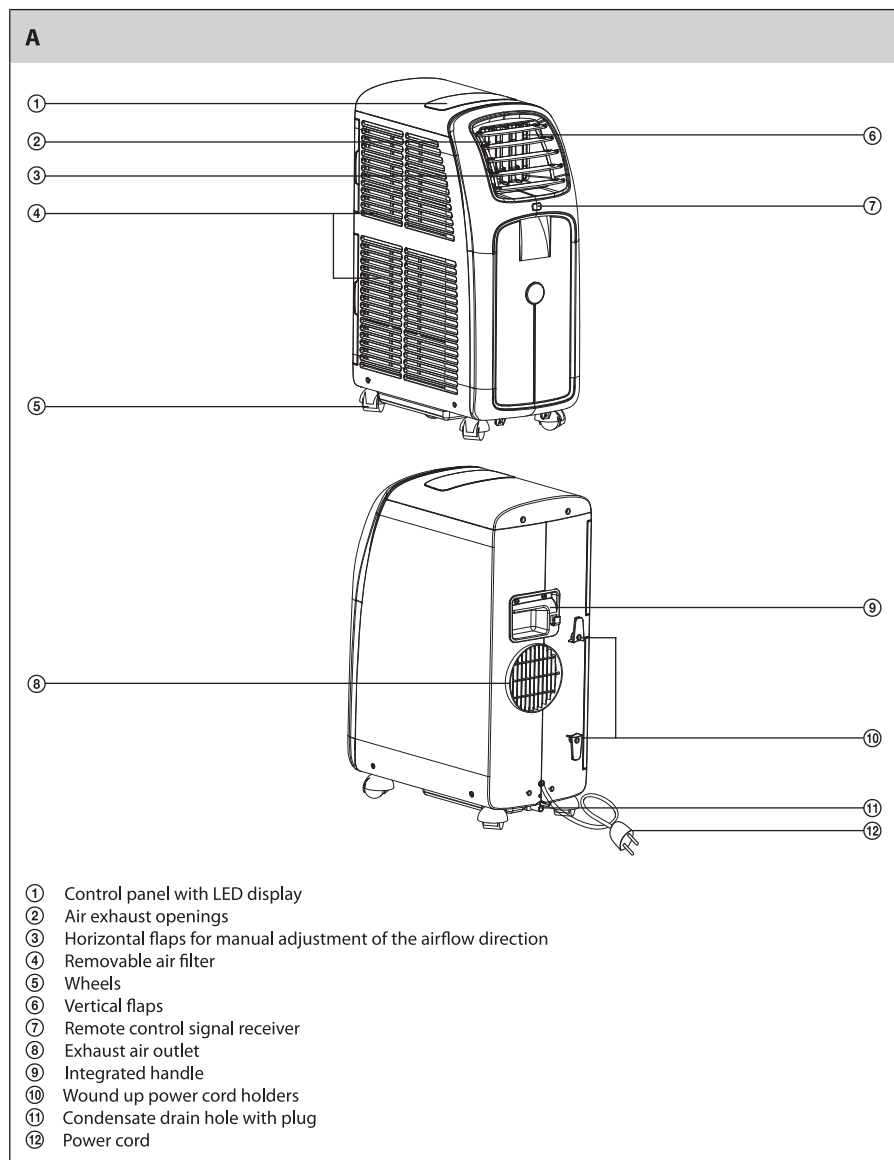

EN-5

DESCRIPTION OF ACCESSORIES

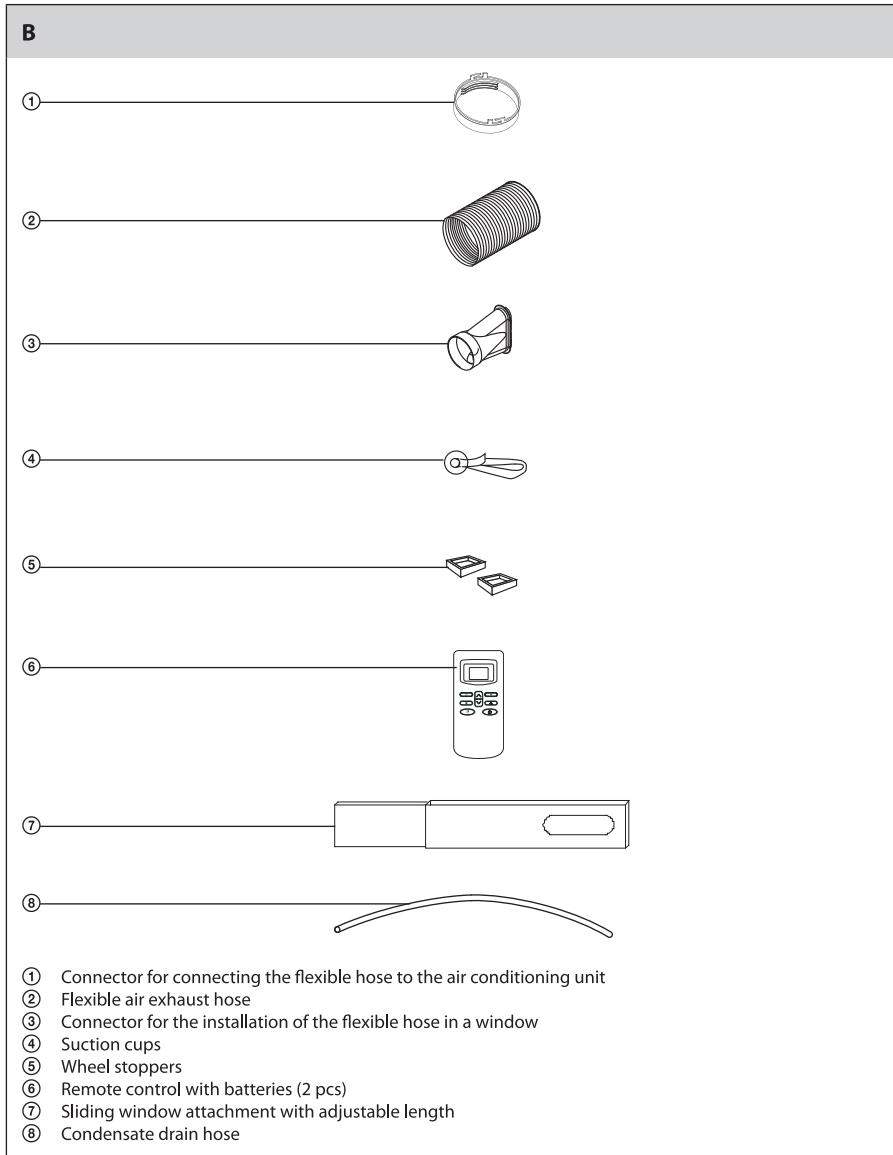

DESCRIPTION OF THE CONTROL PANEL

C

① **SWING touch button**
It is used to activate the automatic movement of the vertical flaps A④ or to deactivate it.

② **Touch button** ↓
It serves to set the temperature in the range from 18 to 32 °C (cooling mode), 13–27 °C (heating mode) or the automatic start or shut off time in the range from 0.5 to 24 hours in the timer setting mode.

③ **MODE touch button**
It serves to select the operating mode: cooling ☀ → dehumidification 💧 → fan 🌀 → heating ☀ → IQ (automatic).

④ **LED display**
Displays the temperature, fan speed, operating mode and the automatic start or shut off timer indicator.

⑤ **Indicator** ☀
Signals the cooling operating mode setting.

⑥ **Indicator** 💧
Signals the dehumidification operating mode setting.

⑦ **Indicator** 🌀
Signals the fan operating mode setting.

⑧ **Indicator** ☀
Signals the heating operating mode setting.

⑨ **Indicator** IQ
Signals the IQ operating mode (automatic mode) setting.

⑩ **Indicator** 🌙
Signals the SLEEP function setting.

⑪ **Indicator** 🌀
The fan speed is shown on a scale.

⑫ **Indicator** ⏰
Signals the automatic start / shut off timer setting.

⑬ **Touch button** ⏻
It is used to turn the air conditioning unit on or off to the stand-by mode.







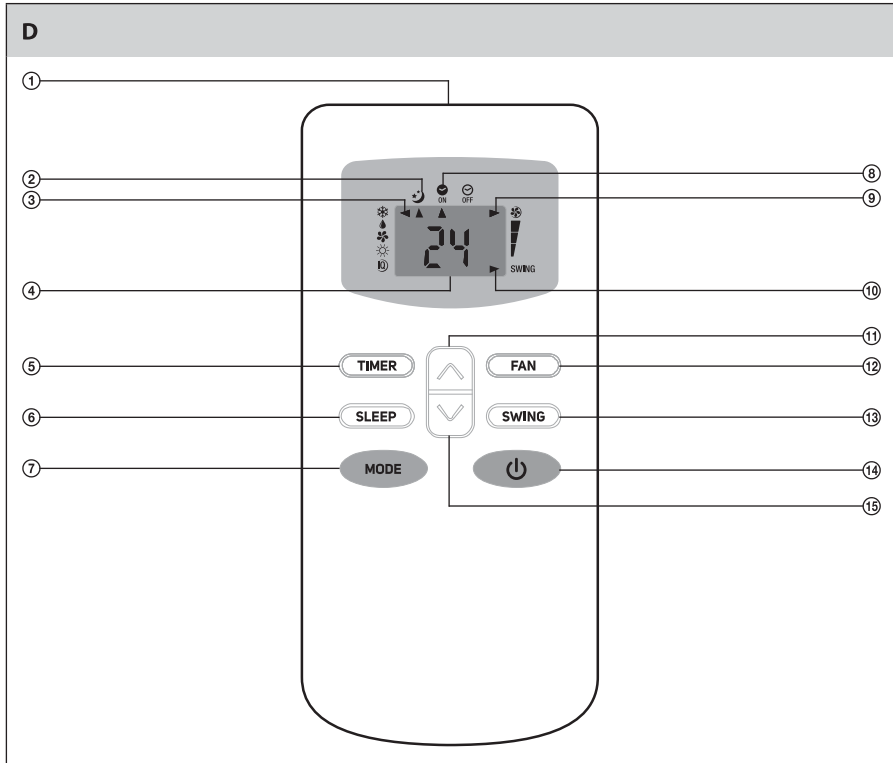





⑭ **Touch button** ↑
It serves to set the temperature in the range from 18 to 32 °C (cooling mode), 13–27 °C (heating mode) or the automatic start or shut off time in the range from 0.5 to 24 hours in the timer setting mode.

⑮ **FAN touch button**
It serves to set the fan speed (low → medium → high → automatic speed).

DESCRIPTION OF THE REMOTE CONTROL



DESCRIPTION OF THE REMOTE CONTROL (CONTINUED)

- ① **Signal transmitter**
- ② **SLEEP function indicator**
If the SLEEP function is activated, the indicator will be shown next to the  symbol.
- ③ **Operating mode indicator**
It appears next to the respective symbol depending on the operating mode setting (cooling , dehumidification , fan , heating  or automatic ).
- ④ **Temperature display**
The set temperature is shown on the display. In the automatic start or shut off timer setting mode, the time is shown on the display of the remote control.
- ⑤ **TIMER button**
It is used to activate the automatic start or shut off timer, to deactivate it or to cancel it.
- ⑥ **SLEEP button**
It is used to set the sleep function.
- ⑦ **MODE button**
It serves to select the operating mode: cooling → dehumidification → fan → heating → IQ (automatic). The operating mode setting is signalled by the display of the an indicator next to the respective symbol.
- ⑧ **Automatic start / shut off timer indicator**
It is shown next to the symbol  or  when the timer is activated.
- ⑨ **Fan speed indicator**
It shows the set fan speed on a scale that is located on the right next to the remote control display.
- ⑩ **SWING function indicator**
It is shown on the display when the automatic vertical flap movement is activated.
- ⑪ ** button**
It serves to set the temperature in the range from 18 to 32 °C (cooling mode), 13–27 °C (heating mode) or the automatic start or shut off time in the range from 0.5 to 24 hours in the timer setting mode.
- ⑫ **FAN button**
It serves to set the fan speed (low → medium → high → automatic speed).
- ⑬ **SWING button**
It is used to activate the automatic movement of the vertical flaps  or to deactivate it.
- ⑭ ** button**
It is used to turn the air conditioning unit on or off to the stand-by mode.
- ⑮ ** button**
It serves to set the temperature in the range from 18 to 32 °C (cooling mode), 13–27 °C (heating mode) or the automatic start or shut off time in the range from 0.5 to 24 hours in the timer setting mode.

INSTALLING THE PORTABLE AIR CONDITIONER

1. Selecting the installation location for the air conditioning unit

- Locate the air conditioning unit on an even, dry and stable surface and within reach of a grounded power socket.
- To achieve optimal efficiency keep the air conditioning unit at least 30 cm away from the wall or other obstacles.



Note:

Do not use the air conditioning unit to cool a room with computer servers, etc.

2. Installing the flexible hose

- The flexible hose B② must be connected to the air conditioning unit and installed into window in accordance with the operating mode that you wish to set.

| Operating mode | Use of the flexible hose B② |
|---|-----------------------------|
| Cooling, dehumidification, heating or automatic | YES |
| Fan | NO |

2.1 Connecting the flexible hose to the air conditioning unit

- First connect the flexible hose B② to connector B① and then secure to the hole in the air exhaust A③.

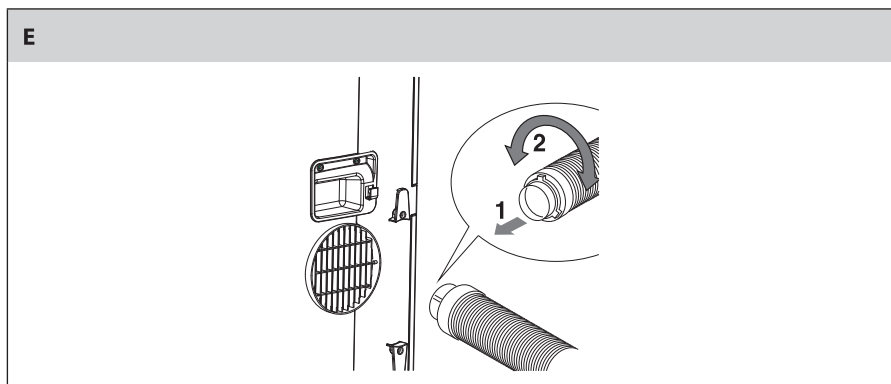

2.2 Installing the flexible hose into window

- It is necessary to install the end of the flexible hose B② into window. Install according to the instructions below.

A. Installing the flexible hose into a window opening to the left or right

- To the loose end of the flexible hose B② attach connector B③.
- Open the window. Stretch out the flexible hose B② so that it is possible to place connector B③ into the window. Avoid excessive bending of the hose B②.
- Place the connector B③ into the window and close the window to the width of the connector B③. To ensure that the window remains closed, secure it in place using the supplied suction cups B④ (see figure F②).



B. Installing the flexible hose into a vertical slide window

- The attachment B⑦ is designed to be compatible with most standard vertical slide windows. Nonetheless, for certain types of slide windows it may be necessary to modify the installation procedure described below.
- Slide the window sash upwards and place the attachment B⑦ on to the window sill. Adjust the length of the attachment B⑧ to the width of the window. Secure the set length of the attachment B⑦ using pins. Close the sliding sash all the way on to the attachment B⑦.
- Stretch out the flexible hose B② so that it is possible to attach the connector B③ to the attachment B⑦. Avoid excessive bending of the hose B②.
- First connect the connector B③ to the hose B② and then connect it to the attachment B⑦, that is installed in the slide window.



ENERGY SAVING TIPS

- To ensure optimal efficiency of the air conditioning unit:
 - do not exceed the recommended room size for which the air conditioning unit was designed, see Table of technical parameters.
 - close windows and doors. If necessary allow the room to ventilate for a short time.
 - close curtains or blinds if sunlight is heating the room through the window panes.
 - regularly clean the air filters.

CONDENSATE DRAIN OUTLET

- The air conditioning unit is equipped with a self-evaporative condensate system. Under normal operating conditions it is not necessary to empty the built-in condensate tank. The water tank may fill up if the air conditioning unit is operated in a room with a high level of humidity or in the heating mode where the self-evaporation system is not automatically activated. For such situations the air conditioner is equipped with a condensate drain outlet A⑩ and a self-diagnostic system which will inform you that the tank is full. When the water tank fills up, the set operating mode will stop automatically. It will resume only after the condensate has been drained.

A. Draining the condensate when the water tank is full or at the end of a season

- If the level of the condensate in the built-in water tank reaches the maximum level, the error message **Ft** will appear on the display of the air conditioning unit. The air conditioning unit will stop automatically. Turn off the air conditioning unit. Wait several minutes and disconnect it from the el. power socket. If the flexible hose B② is installed, disconnect it and move the air conditioning unit to a location where the condensate may be drained. Take off the condensate drain outlet plug A⑩. Allow the condensate to drain out. If no condensate flows from the outlet, tilt the air conditioning unit slightly to allow the water tank to drain fully. Then reattach the plug to the drain outlet A⑩. Reinstall the unit in its location and if necessary put it back into operation.



Note:

For the purpose of draining the condensate, the drain hose B⑧ may be used.

B. Continuous draining of condensate

- In the heating mode the operation of the system does not have self-evaporation of the condensate and so we recommend using continuous draining of condensate. Remove the plug of the condensate drain outlet A⑩ and connect the drain hose B⑧ to it. Check that the hose B⑧ is securely attached to the drain outlet A⑩ so that condensate does not leak out at the connection point. Locate the other end of the hose B⑧ so that the condensate can flow out freely. The hose B⑧ must not be installed above the condensate drain outlet A⑩ and must not be excessively bent.

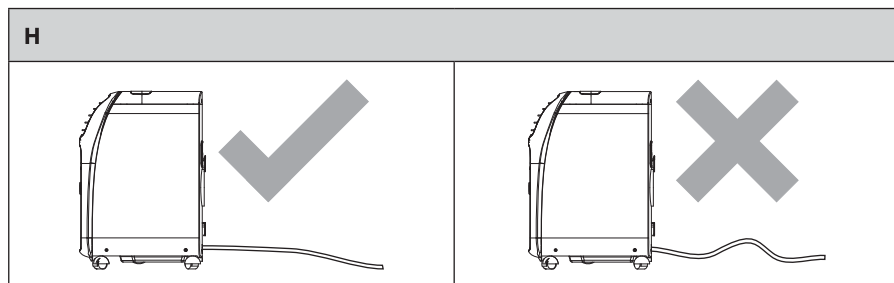

HOW TO CONTROL THE PORTABLE AIR CONDITIONER

- Control panel A① and remote control B⑥ are used to control the air conditioning unit. Buttons for setting the basic functions of the air conditioning unit are located on control panel A①. The remote control B⑥ is used for full control of the air conditioning unit.
- Insert the power plug into an electrical power socket. The connection to a working power socket is indicated by a sound and by all the elements on the display of the air conditioning unit being briefly shown. Then the display shows "--", indicating that the air conditioning unit is in the stand-by mode.

A. Control panel

1. Turning the air conditioning unit on and off

- To turn on the air conditioning unit, press the C⑬ button once. When it is first started, the cooling mode is set automatically. When it is started again, the mode that was activated previously is automatically resumed.
- To turn off the air conditioning unit, press the C⑬ button once more. The air conditioning unit will switch to stand-by mode.



Attention:

Never turn off the air conditioning unit by disconnecting the power cord from the el. power socket. Always turn off the air conditioning unit using the appropriate button and wait several minutes before disconnecting the power cord from the el. power socket.

2. Setting the operating mode

2.1 Cooling mode ❄️

- Repeatedly press the MODE C③ button until the ❄️ symbol appears on the display of the air conditioning unit.
- To set temperatures in the range 18–32 °C, use the C② and C⑭ buttons.
- Set the fan speed using the FAN C⑮ button. The speed of the fan is changed by repeatedly pressing the FAN C⑮ button. There are four fan speed settings available (see figure I).

I

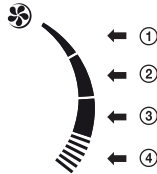

- ① Low speed
- ② Medium speed
- ③ High speed
- ④ Automatic speed

The air conditioning unit will automatically set the most appropriate fan speed based on the selected temperature, which is shown on the display.

- In this mode, the flexible hose B② must be installed and the condensate drain outlet A⑪ must be closed.

2.2 Dehumidification mode 💧

- Repeatedly press the MODE C③ button until the 💧 symbol appears on the display of the air conditioning unit.
- In the dehumidification mode it is not possible to set the fan speed or temperature.
- In this mode, the flexible hose B② must be installed to enable excess humidity to be removed from the room. The condensate drain outlet A⑪ must be closed.

2.3 Fan mode 🌀

- Repeatedly press the MODE C③ button until the 🌀 symbol appears on the display of the air conditioning unit.
- Use the FAN C⑮ button to set the fan speed.

J



- ① Low speed
- ② Medium speed
- ③ High speed



Note:

In this mode it is not possible to set the automatic fan speed.

- In the fan mode it is not possible to set the temperature. Only the fan is running.
- In this mode it is not necessary to install the flexible hose B②. It is recommended to leave the condensate drain outlet A⑪ closed although no condensate is created in this mode.

2.4 Heating mode ☀

- Repeatedly press the MODE C③ button until the ☀ symbol appears on the display of the air conditioning unit.
- To set temperatures in the range 13–27 °C, use the C② and C④ buttons.
- In the heating mode, the fan speed is set automatically and cannot be regulated.
- In this mode the flexible hose B② must be installed. The condensate drain outlet A⑩ must be closed or the condensate drain hose B⑧ must be connected to it.
- The air conditioning unit will start producing hot air within several minutes. The fan may run for a short time even after the set temperature is achieved.
- If the air conditioning unit is operating in the heating mode in very low ambient temperature, automatic defrosting occurs. While the air conditioning unit is defrosting, the heating operating mode is interrupted for a short time and "L E" is shown on the display. The sound made by the air conditioning unit may change during the defrosting procedure. After the defrosting procedure is complete, the set operating mode will be resumed.

2.5 IQ mode (automatic)

- Repeatedly press the MODE C③ button until the IQ symbol appears on the display of the air conditioning unit.
- If you set the IQ operating mode, the air conditioning unit will automatically select the cooling, fan or heating operation.
- In the IQ mode it is not possible to set the temperature. The fan speed can be regulated using the FAN C⑯ button.
- In this mode, the flexible hose C② must be installed and the condensate drain outlet A⑩ must be closed.

3. SWING function (automatic movement of the vertical flaps)

- To activate the automatic movement of the vertical flaps from left to right, press the SWING C① button once.
- To deactivate the automatic movement of the vertical flaps, press the SWING C① button once more.

B. Remote control

1. Inserting and replacing batteries

- Slide out the battery compartment cover, which is located on the rear side of the remote control B⑥. Place two AAA/LR03 (2 x 1.5 V) alkaline batteries into the battery compartment and close the cover.
- When inserting the batteries ensure the correct polarity as shown in the battery compartment.
- When replacing batteries do not combine old and new batteries or batteries of various types.



Note:

Taking the batteries out of the remote control will delete all the settings. After new batteries are inserted the default remote control setting as programmed by the manufacturer will be renewed.

- If you will not be using the remote control for longer than 3 months, remove the batteries.
- ### 2. Using the remote control
- For proper operation of the air conditioning unit, the distance from the remote control B⑥ to the air conditioning unit must not be greater than 7 m and there must not be any obstacles in the direction of the signal. The remote control B⑥ must be pointed in the direction of the signal receiver A⑦ located on the air conditioning unit. The reception of the signal by the air conditioning unit is confirmed by a sound.
 - Do not expose the remote control or the signal receiver on the air conditioning unit to direct sunlight or high temperatures. Otherwise the signal may not be transmitted.

2.1 Turning the air conditioning unit on and off

- To turn on the air conditioning unit, press the D⑭ button once. When it is first started, the cooling mode is set automatically. When it is started again, the mode that was activated previously is automatically resumed.
- To turn off the air conditioning unit, press the D⑭ button once more. The air conditioning unit will switch to stand-by mode.

2.2 Setting the operating mode

2.2.1 Cooling mode ❄️

- Press the MODE D⑦ mode repeatedly until the operating mode indicator D③ appears next to the ❄️ symbol. The same symbol will light up on the display of the air conditioning unit.
- To set temperatures in the range 18–32 °C, use the D⑯ and D⑰ buttons. The set temperature will be shown both on the display of the remote control and on the display of the air conditioning unit.
- Set the fan speed using the FAN D⑫ button. Set the fan speed by repeatedly pressing the FAN D⑫ button as follows: low → medium → high → automatic. The fan speed is shown by the respective indicator on the display of the remote control. The fan speed is also shown on the display of the air conditioning unit.

2.2.2 Dehumidification mode 💧

- Press the MODE D⑦ mode repeatedly until the operating mode indicator D③ appears next to the 💧 symbol. The same symbol will light up on the display of the air conditioning unit.
- In the dehumidification mode it is not possible to set the fan speed or temperature.

2.2.3 Fan mode 🌀

- Press the MODE D⑦ mode repeatedly until the operating mode indicator D③ appears next to the 🌀 symbol. The same symbol will light up on the display of the air conditioning unit.
- Use the FAN D⑫ button to set the fan speed.



Note:

In this mode it is not possible to set the automatic fan speed.

- In the fan mode it is not possible to set the temperature. Only the fan is running.

2.2.4 Heating mode ☀️

- Press the MODE D⑦ mode repeatedly until the operating mode indicator D③ appears next to the ☀️ symbol. The same symbol will light up on the display of the air conditioning unit.
- To set temperatures in the range 13–27 °C, use the D⑱ and D⑲ buttons.
- In the heating mode, the fan speed is set automatically and cannot be regulated.

2.2.5 IQ mode (automatic)

- Press the MODE D⑦ mode repeatedly until the operating mode indicator D③ appears next to the ⑩ symbol. The same symbol will light up on the display of the air conditioning unit.
- If you set the IQ operating mode, the air conditioning unit will automatically select the cooling, fan or heating operation.
- In the IQ mode it is not possible to set the temperature. The fan speed can be regulated using the FAN D⑫ button.

2.3 SLEEP function

- First use the MODE D⑦ button to select the cooling, dehumidification or IQ mode. Then press the SLEEP D⑥ button. The SLEEP function indicator D② will appear on the display of the remote control next to the  symbol. The same symbol will light up on the display of the air conditioning unit.
- The air conditioning unit will continue running in the set mode, however the fan speed will drop to minimum. After 2 hours of operation in the SLEEP mode, the set temperature will automatically increase by 1 °C and after another hour it will again increase by 1 °C. Thereafter, the air conditioning unit will maintain this temperature.





Note:

The SLEEP button D⑥ will not work in the fan and heating mode.

2.4 SWING function (automatic movement of the vertical flaps)



- To activate the automatic movement of the vertical flaps from left to right, press the SWING D⑬ button once. The SWING function indicator D⑩ will appear on the display.
- To deactivate the automatic movement of the vertical flaps, press the SWING D⑬ button once more. The SWING function indicator D⑩ will turn off.

2.5 Setting the automatic start/shut off timer

- If the air conditioning unit is running, press the TIMER D⑤ once to activate the automatic shut off mode. The indicator D⑥ will be lit on the display of the remote control next to the  symbol. The "h" symbol is flashing at the time value. The C⑫ symbol is shown on the display of the air conditioning unit. To set time in the range 0.5 to 24 h, use the D⑯ and D⑰ buttons. In the time interval from 0.5 to 10 h the timer settings change in 30 minute increments, from 10 to 24 h the timer settings change in 1 h increments. Confirm the set time by pressing the TIMER D⑤ button again. Once the set time has elapsed the air conditioning unit will turn itself off. If you wish to cancel the timer setting before the set time has elapsed, press the TIMER D⑤ button once more.
- If the air conditioning unit is off, press the TIMER D⑤ button twice to activate the automatic start mode. The indicator D⑥ will be lit on the display of the remote control next to the  symbol. The "h" symbol is flashing at the time value. The C⑫ symbol is shown on the display of the air conditioning unit. To set time in the range 0.5 to 24 h, use the D⑯ and D⑰ buttons. In the time interval from 0.5 to 10 h the timer settings change in 30 minute increments, from 10 to 24 h the timer settings change in 1 h increments. Confirm the set time by pressing the TIMER D⑤ button again. Once the set time has elapsed the air conditioning unit will turn itself on. If you wish to cancel the timer setting before the set time has elapsed, press the TIMER D⑤ button once more.

SELF-DIAGNOSIS

- The air conditioning unit is equipped with a self-diagnosis system. If an error message appears on the display, follow the instructions in the table below.

| Error message | Solution |
|---|---|
|  | Protection of the compressor Frost protection of the compressor was activated. As soon as the defrosting process is complete, the initially set operating mode will be resumed. |
|  | Sensor error Contact an authorised service centre. |
|  | The built-in condensate tank is full Drain the condensate from the tank according to the instructions in chapter Condensate drain outlet. |

Portable Air Conditioner

SAC MT9012CH

TROUBLESHOOTING TABLE

| PROBLEM / ERROR MESSAGE | POSSIBLE CAUSE | SOLUTION |
|--|---|--|
| The air conditioning unit does not start when the  button is pressed. | The air conditioning unit is not connected to an el. power socket. | Plug the power cord of the air conditioning unit into an el. power socket. |
| | A protective function was activated. | Wait 30 minutes. If the problem persists, contact an authorised service centre. |
| The air conditioning unit works in the cooling, dehumidification, heating or IQ mode for only a short time. | The flexible hose B② is excessively bent. | Remove the bends on the flexible hose B② and set its length to be as short as possible. |
| | The air outlet is blocked by foreign objects. | Check the air outlet hole A⑧ and the flexible hose B② and remove foreign objects blocking the air outlet. |
| The cooling performance of the air conditioning unit is not sufficient. | There are open windows or open doors in the room. | Close the doors and windows in the room. |
| | There are heat sources inside the room. | If possible remove all heat sources from the room. |
| | The flexible hose B② is not properly installed or is blocked. | Properly install the flexible hose B② according to the instructions in chapter Installing the portable air conditioner. Remove objects blocking the air outlet A⑧ or the flexible hose B②. |
| | The set temperature is too high. | Lower the set temperature. |
| | The temperature in the air-conditioned room does not conform to the operating conditions for which the air conditioning unit is designed. | The air conditioning unit must be used under the designated operating conditions. |
| An odour can be smelled when the air conditioning unit is running. | Air filters A④ are clogged with dust. | Clean out the air filters A④ according to the instructions contained in the chapter Maintenance and cleaning. |
| During the operation of the air conditioning unit noise can be heard and vibrations are felt. | The air conditioning unit is not located on an even and stable surface. | Move the air conditioning unit to an even and stable surface. |
| After restarting the air conditioning unit, its operation is resumed after approximately 3 minutes. | This is a function of the compressor. | This is a completely normal event. |
| An error message appears on the display. | The air conditioning unit identified a problem by means of the self-diagnosis system. | Proceed according to the instructions in chapter Self-diagnosis. |

MAINTENANCE AND CLEANING

- Always turn the air conditioning unit off before cleaning. Wait several minutes and then disconnect the power cord from the el. power socket.

1. Cleaning the air filters

- If the air conditioning unit is used regularly, clean the air filters at least once every 14 days to avoid the fan from becoming clogged with dust.
- Hold the air filters A④ by the strip and slide them out of the air conditioning unit.

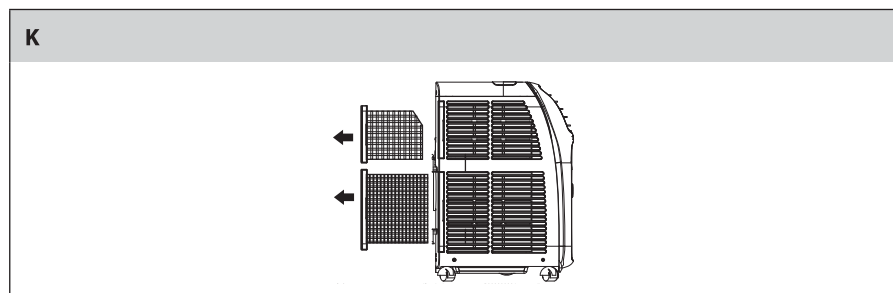

- Use a vacuum cleaner to remove dust from the filters A④. In the event of significant soiling, wash the filters A④ by hand in a solution of lukewarm water (with a temperature max. 40 °C) and neutral detergent. Then thoroughly rinse under flowing water and allow to dry naturally. Do not dry it in a clothes dryer or in direct sunlight.
- Once the filters A④ are dry, you can install them back in their place.



Note:

Do not use the air conditioning unit without properly installed air filters A④.

2. Cleaning the outer case of the air conditioning unit

- To clean the outer case of the air conditioning unit, use a soft wiping cloth dipped in a solution of lukewarm water and neutral detergent. Then wipe the surface of the air conditioning unit dry.
- When cleaning, do not spray the air conditioning unit with water or pour water on it or submerge it in water.
- Do not use abrasive cleaning products, solvents, petrol, etc. for cleaning.

3. Before putting the air conditioning unit out of operation for an extended period of time or before putting it into operation

- Disconnect the flexible hose B②. Store it in a safe place out of the reach of children.
- Drain all the condensate from the built-in water tank as described in chapter Condensate drain outlet.
- Clean the air filters and reattach them to the air conditioning unit. Wipe the outer case of the air conditioning unit and take the batteries out of the remote control.
- Before putting the air conditioning unit into operation again after a long time of inactivity, check that the power cord A⑫ does not exhibit signs of damage and that the air filters A④ are clean. Install the batteries into the remote control B⑥ according to the instructions in chapter Remote control. Install the air conditioning unit in accordance with the instructions in chapter Installing the portable air conditioner.

Portable Air Conditioner

SAC MT9012CH

TECHNICAL SPECIFICATIONS

| | |
|--|--------------------------|
| Model | SAC MT9012CH |
| Power source | 220–240 V~, 50 Hz |
| Power output: cooling heating | 9000 Btu/h 9000 Btu/h |
| Power input: cooling heating | 1010 W 1009 W |
| Current consumption: cooling heating | 4.6 A 4.5 A |
| EER cooling factor | 2.61 |
| COP heating factor | 2.40 |
| Dehumidification capacity | 0.7 l/h |
| Capacity of the built-in condensate tank | 1 l |
| Coolant type and weight | R410A/520 g |
| Air flow volume | 330 m ³ /h |
| Noise level | 54 dB (A) |
| Maximum permitted value of excess operating pressure: Suction/exhaust part of the cooling circuit | 2.1 / 4.2 MPa |
| Dimensions of the air conditioning unit (w x d x h) | 270 × 480 × 695 mm |
| Dimensions of the packaging (w x d x h) | 335 × 540 × 880 mm |
| Weight net/gross | 29.7 / 33.7 kg |
| Operating temperature: Cooling mode Heating mode | 18–35 °C 10–25 °C |
| Recommended room area | 14–21 m ² |

The declared noise emission level of the appliance is 54 dB(A), which represents level A of acoustic power with respect to a reference acoustic power of 1 pW.



Note:

The efficiency of the air conditioning unit may be reduced in the event that it is used outside the above described operating temperature range.

We reserve the right to change text and technical specifications.

INSTRUCTIONS AND INFORMATION REGARDING THE DISPOSAL OF USED PACKAGING

Dispose of packaging material at a public waste disposal site.

DISPOSAL OF USED BATTERIES

Batteries contain environmentally damaging compounds and therefore do not belong in standard household waste. Take the batteries to an appropriate collection point, which will provide for their ecological disposal. You can obtain the contact for the nearest collection point from your town council or from your retailer.

DISPOSAL OF USED ELECTRICAL AND ELECTRONIC EQUIPMENT



The meaning of the symbol on the product, its accessory or packaging indicates that this product shall not be treated as household waste. Please, dispose of this product at your applicable collection point for the recycling of electrical & electronic equipment waste. Alternatively in some states of the European Union or other European states you may return your products to your local retailer when buying an equivalent new product. The correct disposal of this product will help save valuable natural resources and help in preventing the potential negative impact on the environment and human health, which could be caused as a result of improper liquidation of waste. Please ask your local authorities or the nearest waste collection centre for further details. The improper disposal of this type of waste may fall subject to national regulations for fines.

For business entities in the European Union

If you wish to dispose of an electrical or electronic device, request the necessary information from your seller or supplier.

Disposal in other countries outside the European Union

If you wish to dispose of this product, request the necessary information about the correct disposal method from local government departments or from your seller.



This product meets all the basic EU regulation requirements that relate to it.

Portable Air Conditioner

SAC MT9012CH