

Video Camcorder

8mm

SCA30/A33/A35/A80/A85

8 SCA30/A33/A35

Hi 8 SCA80/A85

AF Auto Focus

CCD Charge Coupled Device

Owner's Instruction Book

Before operating the unit, please read this instruction book thoroughly, and retain it for future reference.

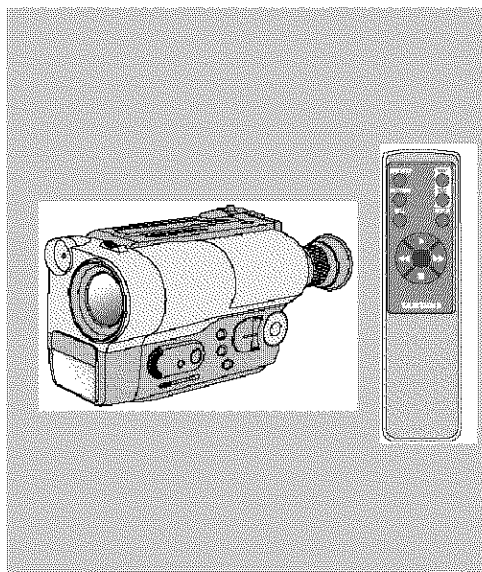

ELECTRONICS

US

Contents

Notices and Safety Instructions

Getting to Know Your Camcorder

Features	12
Descriptions	
■ Front View	13
■ Side View	14
■ Rear View	15
■ OSD (On Screen Display)	16
Accessories Supplied with the Camcorder	18
Remote Control	19
■ Self Timer Recording	19

Preparing

Adjusting the Hand Strap and Shoulder Strap	20
Lithium Battery Installation	20
Connecting the Power Source	21
■ To use the AC Power Adaptor and DC Cable	21
■ To use the Battery Pack	22
Using the Battery Pack	23
■ Refresh	23
■ Time Table	23
■ Battery Level Display	24
Inserting and Ejecting a Cassette	25

Basic Recording

Making your First Recording	26
■ Edit Search	26
Hints for Stable Image Recording	27
Recording with Viewfinder	27
Playing back a tape you have recorded on the Viewfinder	28
Adjusting Focus and Brightness of the Viewfinder	29
Viewing a Still Picture	29
Picture Search	29

Contents (continued)

Advanced Recording

Setting a Function in CAMERAmode	30
Zooming In and Out	32
Digital Zoom	33
EiS (Electronic Image Stabilizer)	34
Program AE (Automatic Exposure)	35
Fade In and Out	36
Creative DSE (Digital Special Effects)	37
Setting and Recording a DATE/TIME	38
Selecting and Recording a TITLE	40
I-BLC/BLC (BLC for SCA30)	41
MF/AF (Manual Focus/Auto Focus)	42
Using the VIDEO LIGHT	43
Lighting Techniques	44

Playing back a Tape

To watch with viewfinder	45
To watch with TV monitor	45
Various Functions in PLAYER mode	46
Setting Audio in the PLAYER mode	47

Maintenance

Cleaning and Maintaining the Camcorder	48
■ Cleaning the Viewfinder	48
■ Cleaning the Video Heads	48
■ Storing the Camcorder	49

Using Your Camcorder Abroad

.....	49
-------	----

Troubleshooting

Self Diagnosis Display	50
Moisture Condensation	50
Troubleshooting	51

Specifications

.....	53
-------	----

Index

.....	54
-------	----

Warranty

.....	56
-------	----

Notices and Safety Instructions

Taking care of the battery pack

- ✦ Do not allow any metal objects to touch the terminals, as this can cause a short circuit and damage the battery pack.

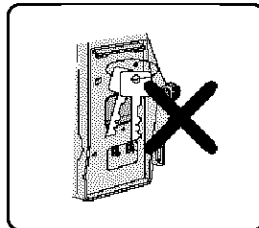

Keep the terminals clean.

- ✦ The camera, adapter or battery pack will not work properly if the terminals are dirty. Check them before use, and wipe them with a dry cloth or tissue if necessary.

Notices regarding electronic viewfinder

- 1) Do not place the camcorder so that the viewfinder is pointing towards the sun. Direct sunlight can damage the inside of the viewfinder. Be careful when placing the camcorder under sunlight or by a window.
- 2) Do not pick up the camcorder by the viewfinder.
- 3) Unintended rotation may cause damage to the viewfinder.

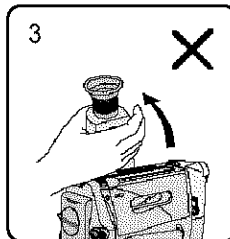
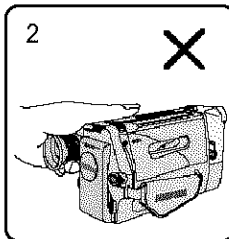
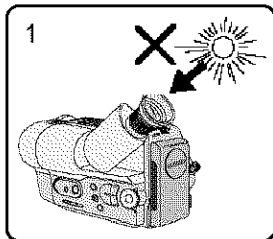

Notices and Safety Instructions

Notices regarding VIDEO LIGHT (SCA35/A85 only)

Danger:

- The video light can become extremely hot. Do not touch it during operation or after turning it off, otherwise serious injury may result.
It takes 5 minutes (approx.) for the light to cool down.
- Do not place the camcorder into the carrying case immediately after using the video light.
The video light will be hot. Please allow time for it to cool down.
- Do not use near flammable or explosive materials.
- It is recommended that you consult your nearest SAMSUNG dealer for replacement bulbs.

***DANGER** - NOT TO BE HANDLED BY CHILDREN.
EMITS INTENSE HEAT AND LIGHT.
USE WITH CAUTION TO REDUCE THE RISK OF FIRE OR INJURY TO PERSONS.
DO NOT DIRECT LIGHT AT PERSONS OR MATERIALS FROM LESS THAN FOUR FEET DURING USE AND UNTIL COOL.
DISCONNECT WHEN NOT IN USE.

***DANGER** - TO PREVENT POSSIBLE BURN HAZARD, DISCONNECT SUPPLY CORD AND ALLOW LAMP TO COOL BEFORE REPLACING.
REPLACE ONLY WITH JC6V-3W/G2.5, TO REDUCE THE RISK OF FIRE.

Notices regarding moisture condensation

1) A sudden rise in atmospheric temperature may cause condensation to form inside the camcorder.

for example:

- When you move the camcorder from cold outside to warm inside during the winter.
 - When you move the camcorder from cool inside to hot outside during the summer.
- 2) If the "DEW" protection feature is activated, leave the camcorder for at least two hours in a dry, warm room with the cassette compartment opened and the battery removed.
- 3) If the "DEW" protection feature is activated unexpectedly, and you want to override it, detach then reinstall the battery pack and lithium battery. (see page 20)
Please make sure that the condensation has disappeared completely.



Notices and Safety Instructions

Notices regarding the battery pack

- ✦ Make sure that the battery pack is charged before shooting outdoors.
- ✦ To preserve battery power, keep your camcorder turned off when you are not operating it.
- ✦ When your camcorder is in CAMERA mode, if it is left set to STANDBY for more than 5 minutes without operation, it will automatically turn off to protect against unexpected battery discharge.
- ✦ Make sure that the battery pack is fitted firmly into place.
Dropping the battery pack may damage it.

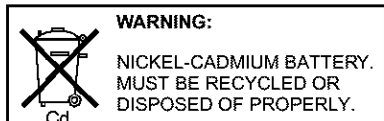
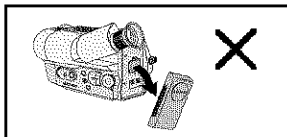

*When the battery reaches the end of its life please contact your local dealer. The batteries have to be dealt with as chemical waste.

Notices regarding the Lithium battery

Caution: Keep the LITHIUM BATTERY out of the reach of children.
Should the battery be swallowed, consult a doctor immediately.

- ✦ The lithium battery maintains the clock function, title and preset contents memory; even if the battery pack or AC power adaptor is removed.
- ✦ The lithium battery for the camcorder lasts for about 8~10 months under normal operation from time of installation.
- ✦ When the lithium battery becomes weak or dead, the date/time indicator flashes for about 5 seconds when you set the power switch to CAMERA. In this case, replace the lithium battery with type CR2025. (see page 20)

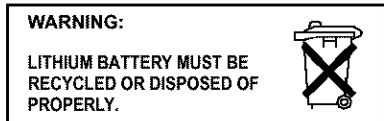

*When the lithium battery becomes weak or dead please contact your local dealer. The batteries have to be dealt with as chemical waste.

Notice regarding the LENS

- ✦ Do not record in direct sunlight with the LENS pointing toward the sun.
Direct sunlight can damage the CCD.

Notices and Safety Instructions

Notices regarding the hand strap

- ✦ It is very important to adjust the hand strap for better shooting. (see page 20)
- ✦ Do not insert your hand in the hand strap forcibly, the buckle may be damaged.

Note: Do not carry the camcorder by the handstrap only.

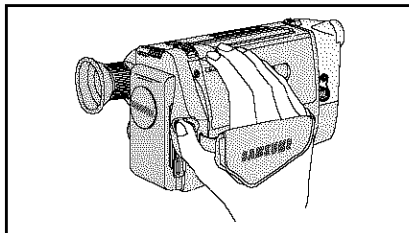

Notices regarding video head cleaning

- ✦ To ensure normal recording and clear picture, clean the video heads. When the playback pictures are noisy or hardly visible, the video heads may be dirty. If this happens, clean the video heads with a dry type cleaning cassette.
- ✦ Do not use a wet type cleaning cassette. It may damage the video heads. (see page 48)

5 minutes off timer in STBY mode

- ✦ To protect against tape and head-drum wear, your camcorder will automatically turn off if it is left in STBY mode without operation for more than 5 minutes.

Notices and Safety Instructions

Safety Instructions



CAUTION
RISK OF ELECTRIC SHOCK
DO NOT OPEN



CAUTION:
TO REDUCE THE RISK OF ELECTRIC SHOCK, DO NOT REMOVE COVER (OR BACK). NO USER SERVICEABLE PARTS INSIDE. REFER SERVICING TO QUALIFIED SERVICE PERSONNEL.



This symbol is intended to alert the user to the presence of uninsulated dangerous voltage within the product's enclosure that may be of sufficient magnitude to constitute a risk of fire or electric shock.



This symbol is intended to alert the user to the presence of important operating and maintenance instructions in the literature accompanying this product.

To prevent electric shock, match wide blade of plug to wide slot and fully insert.

1. READ INSTRUCTIONS:

All the safety and operating instructions should be read before the CAMCORDER is operated.

2. RETAIN INSTRUCTIONS:

The safety and operating instructions should be retained for future reference.

3. HEED WARNINGS:

All warnings on the CAMCORDER and in the operating instructions should be adhered to.

4. FOLLOW INSTRUCTIONS:

All operating and maintenance instructions should be followed.

5. CLEANING:

Unplug this CAMCORDER from the wall outlet before cleaning. Do not use liquid or aerosol cleaners. Use a dry cloth used for dusting cabinets.

6. ATTACHMENTS:

Do not use attachments not recommended by the CAMCORDER product manufacturer as they may be hazardous.

7. WATER AND MOISTURE:

Do not use this CAMCORDER near water; for example, near a bathtub, wash bowl, kitchen sink, laundry tub, in a wet basement, near a swimming pool or lake.

8. ACCESSORIES:

Do not place this CAMCORDER on an unstable cart, stand, tripod, bracket or table. The CAMCORDER may fall, causing serious injury to a child or adult, and serious damage to the unit. Use only with a cart, stand, tripod, bracket, or table recommended by the manufacturer or sold with the CAMCORDER. Any mounting of the unit should follow the manufacturer's instructions and should use a mounting accessory recommended by the manufacturer.

A. An appliance and cart combination should be moved with care.

Quick stops, excessive force and uneven surfaces may cause the appliance and cart combination to overturn.

PORTABLE CART WARNING
(Symbol provided by RETAC)



Notices and Safety Instructions

9. VENTILATION:

Slots and openings in the cabinet are provided for ventilation to ensure reliable operation of the CAMCORDER and to protect it from overheating. These openings must not be blocked or covered. Never place your CAMCORDER on a bed, sofa, rug, or other similar surface: on or near a radiator or heat register.

This CAMCORDER should not be placed in a built-in installation such as a bookcase or rack unless proper ventilation is provided or the manufacturer's instructions have been adhered to.

10. POWER SOURCES:

The CAMCORDER should be operated only from the type of power source indicated on the label.

If you are not sure of the type of power supply at your home, consult your appliance dealer or local power company.

A CAMCORDER is intended to be operated from battery power, or other sources, refer to the operating instructions.

11. GROUNDING OR POLARIZATION:

This CAMCORDER may be equipped with either a polarized 2-wire AC line plug (a plug having one blade wider than the other) or a 3-wire grounding type plug, a plug having a third (grounding) pin. If you are unable to insert the plug fully into the outlet, try reversing the plug. If the plug still fails to fit, contact your electrician to replace your outlet. Do not defeat the safety purpose of the polarized plug.

12. POWER-CORD PROTECTION:

Power-supply cords should be routed so that they are not likely to be walked on or pinched by items placed upon or against them, paying particular attention to cords or plugs, convenient receptacles, and the point where they exit from the unit.

13. OUTDOOR ANTENNA GROUNDING:

If an outside antenna or cable system is connected to the CAMCORDER, be sure the antenna or cable system is grounded to provide some protection against voltage surges and built-up static charges, Section 810 of the National Electrical Code, ANSI/NFPA No. 70-1984, provides information with respect to proper grounding of the mast and supporting structure, grounding of the lead-in wire and supporting structure, grounding of the mast and supporting structure, grounding of the lead-in wire to an antenna discharge unit, size of grounding to conductors, location of antenna-discharge unit, connection to grounding electrodes and requirements for the grounding electrode.

See figure below.

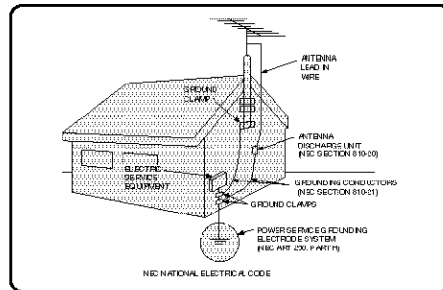

Notices and Safety Instructions

14. LIGHTNING:

For added protection of this CAMCORDER during a lightning storm or when it is left unattended and unused for long periods of time, unplug it from the wall outlet and disconnect the antenna or cable system.

This will prevent damage to the CAMCORDER due to lightning and power-line surges.

15. POWER LINES:

An outside antenna system should not be located in the vicinity of overhead power lines or other electric light or power circuits where it can fall into such power lines or circuits.

When installing an outside antenna system, extreme care should be taken to keep from touching such power lines or circuits as contact with them might be fatal.

16. OVERLOADING:

Do not overload wall outlets and extension cords as this can result in a risk of fire or electric shock.

17. OBJECTS AND LIQUIDS:

Never push objects of any kind into this CAMCORDER through openings as they may touch dangerous voltage points or short out a part that could result in a fire or electric shock.

Never spill liquids of any kind onto the CAMCORDER. Should spillage occur, unplug unit and have it checked by a technician before use.

18. SERVICING:

Do not attempt to service this CAMCORDER yourself. Opening or removing covers may expose you to dangerous voltage or other hazards. Refer all servicing to qualified service personnel.

19. DAMAGE REQUIRING SERVICE:

Unplug this CAMCORDER from the wall outlet and refer servicing to qualified service personnel under the following conditions:

- a. When the power-supply cord or plug is damaged.
- b. If any liquid has been spilled onto, or objects have fallen into the CAMCORDER.
- c. If the CAMCORDER has been exposed to rain or water.
- d. If the CAMCORDER does not operate normally by following the operating instructions, adjust only those controls that are covered by the operating instructions. Improper adjustment of other controls may result in damage and will often require extensive work by a qualified technician to restore the CAMCORDER to its normal operation.
- e. If the CAMCORDER has been dropped or the cabinet has been damaged.
- f. When the CAMCORDER exhibits a distinct change in performance, this indicates a need for service.

20. REPLACEMENT PARTS:

When replacement parts are required, be sure the service technician has used replacement parts specified by the manufacturer and having the same characteristics as the original part. Unauthorized substitutions may result in fire, electric shock or other hazards.

21. SAFETYCHECK:

Upon completion of any service or repairs to this CAMCORDER, ask the service technician to perform safety checks to determine that the CAMCORDER is in safe operating order.

Notices and Safety Instructions

NOTE TO CATV SYSTEM INSTALLER:

This reminder is provided to call the CATV system installer's attention to Article 820-40 of the NEC that provides guidelines for proper grounding and, in particular, specifies that the cable ground shall be connected to the grounding system of the building as close to the point of cable entry as practical.

USER INSTALLER CAUTION:

Your authority to operate this FCC certified equipment could be voided if you make changes or modifications not expressly approved by this party responsible for compliance to part 15 FCC rules.

Getting to Know Your Camcorder

Features

Your camcorder has many features for recording and playback.

I-BLC/BLC

■ I-BLC: Intelligent Back Light Compensation.

When you shoot a subject with the light source behind the subject or a subject with a light background, use the I-BLC/BLC function. (see page 41)

■ Models SCA33/A35/A80/A85 have I-BLC/BLC.

■ Model SCA30 has BLC.

DSE (Digital Special Effects)

The DSE enables you to give a creative look to your films by adding various special effects.(see page 37)

Program AE (Auto Exposure)

The Program AE enables you to adapt the shutter speed and aperture to the type of scene to be filmed.(see page 35)

EIS (Electronic Image Stabilizer, SCA35/A85 only)

To compensate for unstable images caused by hand shake, particularly at high magnification. (see page 34)

22x High ratio zoom lens (SCA35/A80/A85 only)

Zooming is a recording technique that lets you change the size of the subject in the scene.

For more professional recordings, use the zoom function. (see page 32)

Digital zoom

Zooming more than 22x (SCA35/A80/A85 only) zoom is achieved digitally. (see page 33)

Macro

The macro function allows you to shoot your subject at close range.

You have to adjust the zoom to full wide for macro shooting. (see page 32)

Getting to Know Your Camcorder

Front View

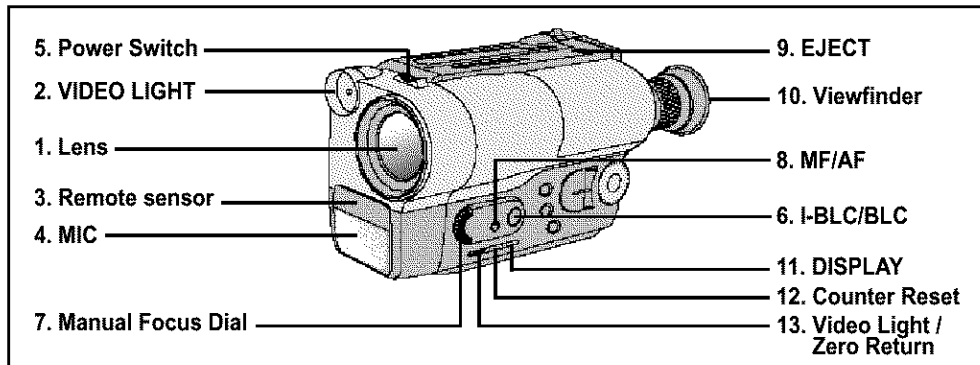

- | | |
|---|--|
| <p>5. Power Switch</p> <p>2. VIDEO LIGHT</p> <p>1. Lens</p> <p>3. Remote sensor</p> <p>4. MIC</p> <p>7. Manual Focus Dial</p> | <p>9. EJECT</p> <p>10. Viewfinder</p> <p>8. MF/AF</p> <p>6. I-BLC/BLC</p> <p>11. DISPLAY</p> <p>12. Counter Reset</p> <p>13. Video Light / Zero Return</p> |
|---|--|
-
- | | |
|---|---|
| <p>1. Lens (see page 53)</p> <p>2. VIDEO LIGHT (see page 43)
To brighten the scene when natural lighting is too dim. (SCA35/A85 only)</p> <p>3. Remote sensor (see page 19)
(not available on SCA30)</p> <p>4. MIC
- SCA30/A33/A35: Monaural
- SCA80/A85: Stereo</p> <p>5. Power Switch (see page 21)
- CAMERA: Select to record.
- OFF: Select to turn off the camcorder.
- PLAYER: Select to play back.</p> <p>6. I-BLC/BLC (see page 41)
I-BLC/BLC works in CAMERA mode.
(BLC for SCA30)</p> | <p>7. MANUAL FOCUS DIAL (see page 42)</p> <p>8. MF/AF (see page 42)
MF/AF works in CAMERA mode.</p> <p>9. EJECT (see page 25)
Use when ejecting the tape.</p> <p>10. Viewfinder (see page 27)
SCA33/A35/A80/A85 is color.
SCA30 is black & white.</p> <p>11. DISPLAY (see page 16)
Use to turn the OSD on or off.</p> <p>12. COUNTER RESET
Use to reset the tape counter.</p> <p>13. VIDEO LIGHT/ZERO RETURN
Video Light (SCA35/A85) works in CAMERA mode. Use to turn the video light on or off. (see page 43)
Zero return works in PLAYER mode. (see page 47)</p> |
|---|---|

Getting to Know Your Camcorder

Side View

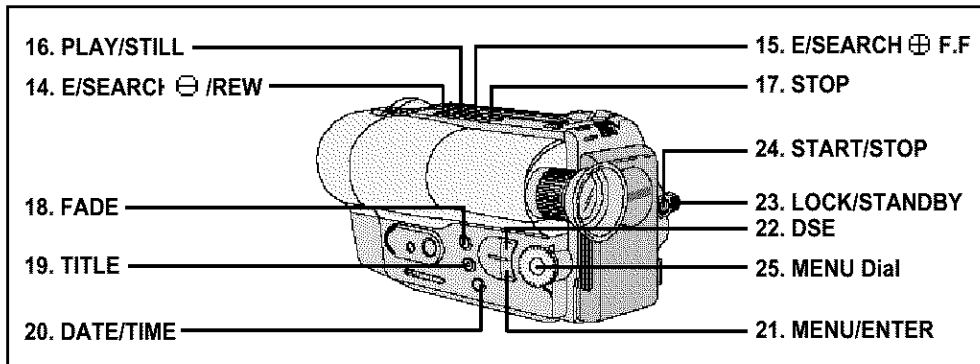

14. E/SEARCH ⊖ /REW (see page 26)

E/SEARCH ⊖ works in STANDBY mode.
REW works in PLAYER mode.

15. E/SEARCH ⊕ F.F (see page 26)

E/SEARCH ⊕ works in STANDBY mode.
F.F works in PLAYER mode.

16. PLAY/STILL

17. STOP

18. FADE (see page 36)

Fade works in CAMERA mode.

19. TITLE (see page 41)

TITLE works in CAMERA mode.

20. DATE/TIME (see page 38, 39)

DATE/TIME works in CAMERA mode.

21. MENU/ENTER (see page 30)

MENU/ENTER works in CAMERA and
PLAYER mode.
(PLAYER mode: SCA80/A85 only)

22. DSE (see page 37)

DSE (Digital Special Effects) works in
CAMERA mode.

23. LOCK/STANDBY (see page 21)

- LOCK: off
- STANDBY: CAMERA

24. START/STOP (see page 26)

START/STOP button works in
CAMERA mode.

25. MENU Dial

MENU Dial works in CAMERA and
PLAYER mode.

Getting to Know Your Camcorder

Rear View

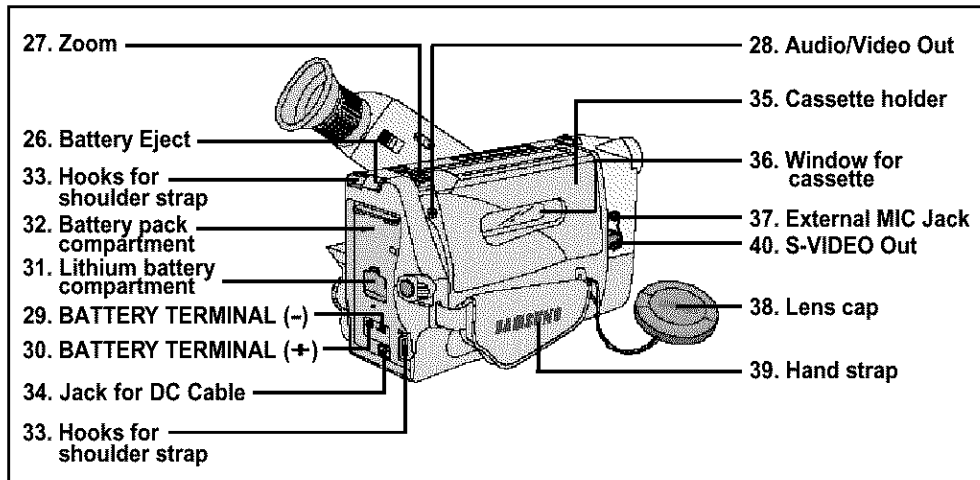

26. BATTERY EJECT (see page 22)

27. ZOOM (see page 32)
Zoom works in CAMERA mode.

28. AUDIO/VIDEO OUT
(see page 45)

29. BATTERY TERMINAL(-)

30. BATTERY TERMINAL(+)

31. Lithium battery compartment
(see page 20)

32. Battery pack compartment (see page 22)

33. Hooks for shoulder strap
(see page 20)

34. Jack for DC Cable (see page 21)

35. Cassette holder (see page 25)

36. Window for cassette (see page 25)

37. External MIC Jack (see page 53)

38. Lens cap (see page 27)
(SCA30/A33/A80 only)

39. Hand strap (see page 20)

40. S-VIDEO OUT (see page 45)
(SCA80/A85 only)

Getting to Know Your Camcorder

OSD (On Screen Display)

- ✦ The OSD on/off is switched by the DISPLAY button.
- ✦ The title and date/time functions can continue to function when the OSD is turned off.
- ✦ The OSD is displayed in the viewfinder and the monitor.

a.Zoom position (see page 33)

Indicates zoom position.

b.Battery level (see page 24)

Indicates the real time battery level.



c. Manual Focus (see page 42)

Indicates that the manual focus is working.

Auto Focus is not displayed.

d.I-BLC/BLC (see page 41)

Indicates the I-BLC/BLC is working.
(BLC for SCA30)

e.Program AE (see page 35)

Indicates the Program AE mode is working. ()

f. EIS (SCA35/A85 only)

(see page 34)

Indicates that the EIS is working.

g.Video light (SCA35/A85 only)

(see page 43)

Indicates that the Video Light is turned on.

OSD in CAMERA mode

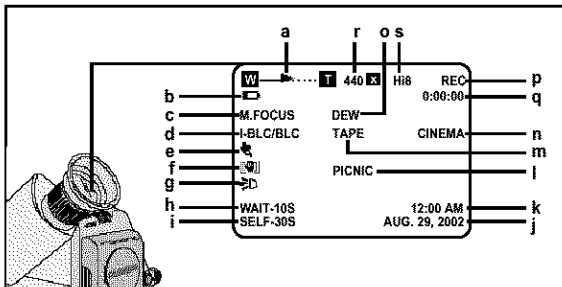

OSD in PLAYER mode

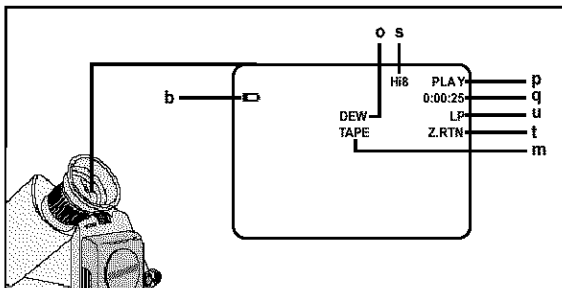

Getting to Know Your Camcorder

- h. Self record waiting timer (see page 19)**
Indicates 10 second timer.
- i. Self record recording timer (see page 19)**
(30 seconds and END).
- j. Date (see page 38, 39)**
Indicates the date you are recording.
- k. Time (see page 38, 39)**
Indicates the time you are recording.
- l. Title (see page 40, 41)**
Indicates the recorded title you have set.
It is superimposed on the scene.
- m. Self diagnosis (see page 50)**
Monitors self diagnosis (TAPE, TAPE END).
- n. DSE (Digital Special Effect) (see page 37)**
Indicates the DSE mode is working.
The operation modes are MAKE-UP, EMBOSS, WIDE(16:9), CINEMA, NEG., MIRROR, MOSAIC.
- o. DEW condensation (see page 50)**
Monitors the moisture condensation.
- p. Operation mode**
Indicates the operation mode.
The operation modes are STBY, REC, STOP, PLAY, FF, REW.
- q. Tape counter**
Indicates amount of tape used.
We recommend that you reset the tape counter with the COUNTER RESET button before you start shooting.
- r. Digital zoom (see page 33)**
Indicates that the digital zoom is working.
- s. Hi8 (SCA80/A85 only) (see page 25)**
Indicates that you are using Hi8 tape when recording or playing back.
- t. Zero return (see page 47)**
Indicates that the zero return is working.
- u. Playback speed**
Indicates the playback speed in PLAYER mode.
SP is not displayed.







Getting to Know Your Camcorder

Accessories Supplied with Camcorder

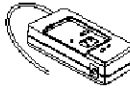
Make sure that the following basic accessories are supplied with your camcorder.





Basic Accessories

1. AC Power Adaptor. (see page 21)
2. DC Cable. (see page 21)
3. Battery Pack. (see page 22)
(NC-120 for SCA30)
4. Audio/Video Cable. (see page 45)
(SCA30/A33/A35: monaural
SCA80/A85: stereo)
5. Shoulder strap. (see page 20)
6. Instruction Book.
7. Lithium Battery for Clock
(TYPE: CR2025) (see page 20)

<p>1. AC Power Adaptor</p>  <p>AD44-00001A</p>	<p>2. DC Cable</p>  <p>AD39-60001A</p>	<p>3. Battery Pack</p>  <p>NC-120: AD59-10377A NH-180: AD43-00004A</p>
<p>4. AUDIO/VIDEO Cable</p>  <p>Monaural: AD39-40200A Stereo: AD39-00001A</p>	<p>5. Shoulder Strap</p>  <p>AD63-00007A</p>	<p>6. Instruction Book</p> 
<p>7. Lithium Battery</p>  <p>AD43-10130A</p>		

Optional Accessories

8. S-VIDEO cable. (SCA80/A85 only)
9. Cassette. (see page 25)
10. Carrying Case.
11. Remote Control. (see page 19)
(not available on SCA30)
12. Battery for Remote Control. (see page 19)
(not available on SCA30)

<p>8. S-VIDEO cable</p>  <p>AC39-42001Z</p>	<p>9. Cassette</p> 	<p>10. Carrying Case</p>  <p>AD69-00001A</p>
<p>11. Remote Control</p>  <p>AD59-10536B</p>	<p>12. Two R6 AA batteries</p> 	

Note: Optional accessories may be included with the camcorder, depending on the country in which it is purchased.

Getting to Know Your Camcorder

Remote Control (not available on SCA30)

Description of Parts

1. START/STOP (see page 26)
2. SELF TIMER
3. STILL (see page 46)
4. WIDE (see page 32)
5. TELE (see page 32)
6. DISPLAY (see page 16)
7. ► (Play) (see page 46)
8. ◀◀ (Rewind) (see page 46)
9. ■ (Stop) (see page 46)
10. ►► (Fast Forward) (see page 46)

If the camcorder's remote sensor is exposed to direct sunlight or strong artificial light, the camcorder may not respond to the Remote Control.

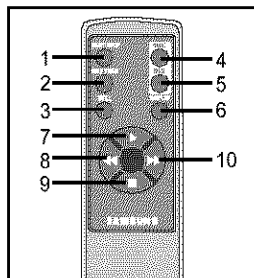

Remote Control Battery Installation

- ✦ You must insert or replace these batteries when:
 - You purchase the camcorder.
 - The remote control no longer works correctly.
- ✦ Insert two AA batteries, following the + and - markings.
- ✦ Be careful not to reverse the polarity of the battery.

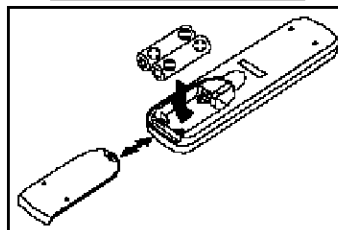

Self Record using the Remote Control

- ✦ The Self Timer function on the remote control enables you to start and stop recording automatically.

Example: Scene with all members of your family

- ✦ Two options are available
 - WAIT-10S/SELF-30S: 10 second wait, followed by 30 seconds of recording.
 - WAIT-10S/SELF-END: 10 second wait, followed by recording until you press the START/STOP button again.
1. Set the camcorder to STANDBY. (see page 21)
 2. Press the SELF TIMER button until the appropriate indicator is displayed in the viewfinder:
 - WAIT-10S/SELF-30S
 - WAIT-10S/SELF-END
 3. Press the START/STOP button to start the timer.
 - : After a 10 second wait, recording starts.
 - : If you have selected SELF-30S, recording stops automatically after 30 seconds.
 - : If you have selected SELF-END, press START/STOP again when you wish to stop recording.

Note: When recording with the timer, you can press START/STOP a second time to cancel the function.

Preparing

Adjusting the Hand Strap and Shoulder Strap

Hand Strap

- ✦ It is very important to adjust the hand strap for better shooting.
 - ✦ The hand strap enables you to:
 - Hold the camcorder in a stable, comfortable position.
 - Press the Zoom and red Record buttons without having to change the position of your hand.
1. Pull open the Hand Strap cover and release the Hand Strap, adjust its length and stick it back onto the Hand Strap cover.
 2. Close the Hand Strap cover back up again.

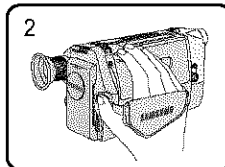
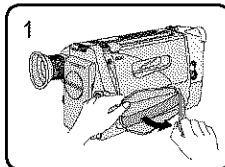

Shoulder Strap

- ✦ The Shoulder Strap enables you to carry your camcorder around in complete safety.
1. Insert each end into the shoulder strap hooks on the camcorder.
 2. Thread each end into the buckle, adjust the length of the strap and then pull it tight in the buckle.

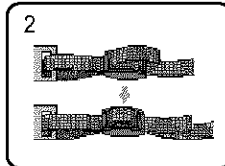
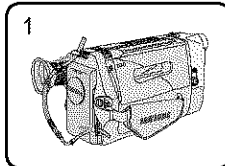

Lithium Battery Installation

- ✦ The lithium battery maintains the clock function, title and preset contents memory; even if the battery pack or AC power adaptor is removed.
- ✦ The lithium battery for the camcorder lasts for about 8~10 months under normal operation from time of installation.
- ✦ When the lithium battery becomes weak or dead, the date/time indicator flashes for about 5 seconds when you set the power switch to CAMERA. When this occurs, replace the lithium battery with type CR2025.

1. Open the lid of the LITHIUM BATTERY compartment.
2. If replacing, push the LITHIUM BATTERY down once and pull it out from the holder.
3. Install the LITHIUM BATTERY with the positive side facing out. Close the lid.

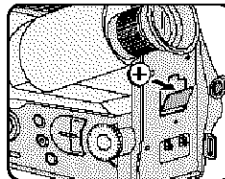
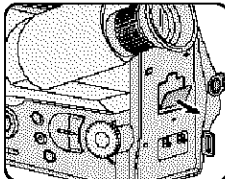

Caution: Keep the LITHIUM BATTERY out of the reach of children.
Should the battery be swallowed, consult a doctor immediately.

Preparing

Connecting the Power Source

- ✦ There are two ways to connect a power source.
 - Using the AC power adaptor and DC Cable: used for indoor recording.
 - Using the Battery Pack: used for outdoor recording.

To use the AC Power Adaptor and DC Cable

1. Connect the AC power adaptor to a wall socket.
- Note: The plug and wall socket type may be different from one country to another.
2. Connect the DC Cable to jack of the AC Power Adaptor.
3. Connect the other end of the DC Cable to the camcorder.

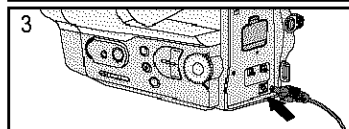
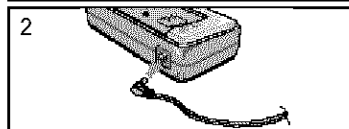
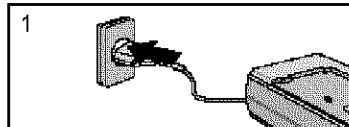

4. To set the camcorder to the CAMERAmode.
 - a. Hold down the tab of the switch and push the switch to the CAMERA position.
 - b. Set the LOCK/STANDBY switch to STANDBY.
 - c. Make sure that the Lens Cap is open. (On models SCA35/A85 the Lens Cap opens automatically when you set the power switch to the CAMERA position).
 - d. Make sure that the image appears in the viewfinder.

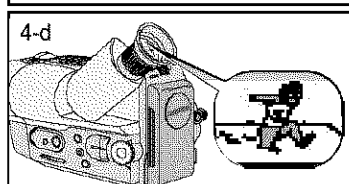
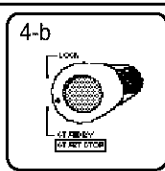
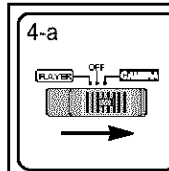

Note: If the adaptor is used next to a TV or the camcorder, it may cause the TV or camcorder to emit noise-move the adaptor away from the TV, camcorder or the antenna cable.

Preparing

To use the Battery Pack

- ✦ Amount of continuous recording time depends on:
 - Which model of battery pack you are using.
 - How much you use the Zoom function.

It is, therefore, recommended that you have several available.

◆ Charging the Battery Pack

1. Connect the AC power adaptor to a wall socket.
2. Attach the battery pack to the AC power adaptor by aligning it with the left of the AC power adaptor, pressing down on the battery and sliding it to the right.
 - The CHARGE/REFRESH indicator flashes red.
 - When the battery pack is fully charged, the red CHARGE indicator comes on (not flashing).

Note: If the DC Cable is plugged into the AC power adaptor, the battery will not be charged.

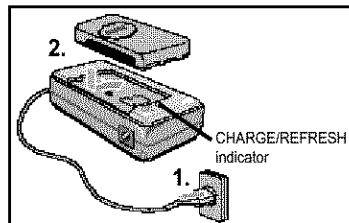

◆ Connect the Battery Pack to the camcorder

3. Once the battery pack has been completely charged, you can attach it to the camcorder.
 - Lift the viewfinder up so that it is not in the way.
 - Align the bottom of battery pack (end opposite the tab with the red dot) with the bottom of the battery compartment on the rear of the camcorder.
 - Push the top of the battery into the compartment until it clicks twice into place.
 - Make sure that the battery pack is fitted firmly into place to avoid damage by dropping.
4. To set the camcorder to the Camera mode.
 - a. Hold down the tab of the switch and push the switch to the CAMERAPosition.
 - b. Set the LOCK/STANDBY switch to STANDBY.
 - c. Make sure that the Lens Cap is open. (On models SCA35/A85 the Lens Cap opens automatically when you set the power switch to the CAMERAPosition)
 - d. Make sure that the image appears in the viewfinder.

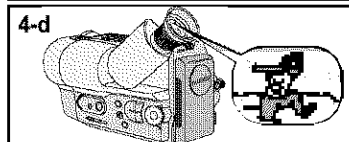
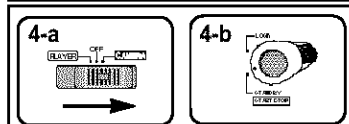
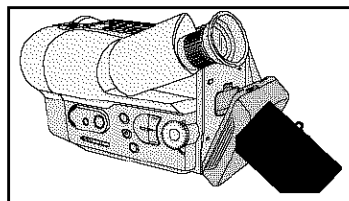

◆ Removal of the Battery Pack

1. Carefully supporting the battery pack, slide the BATT.EJECT button in the direction of the arrow, until the battery is released.
2. Pull out the battery pack carefully.

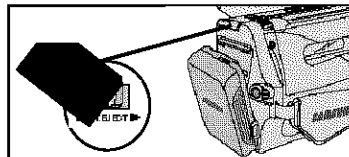

Preparing

Using the Battery Pack

Battery pack usage time may be shortened in the following cases:

- ✦ The first charging after purchase of the battery pack.
- ✦ When you charge a battery pack which has not been fully discharged.
- ✦ When the battery pack is not used for a long period of time.
When this occurs, the REFRESH (discharge) function should be used to increase the capacity of the battery pack.

Using the REFRESH (discharge) function

The REFRESH (discharge) function is designed to help the battery pack last longer by discharging it completely before it is recharged.

1. Connect the AC power adaptor to a wall socket.
Attach the battery pack to the AC power adaptor.
 - The CHARGE/REFRESH indicator flashes red.
2. Press the REFRESH button.
 - The CHARGE/REFRESH indicator flashes green.
 - Refreshing (discharging) time is different, depending on how much power remains in the battery pack.
 - After refreshing (discharging) the battery pack, the charge function starts automatically.
 - When you wish to stop discharging, remove the battery pack from the AC power adaptor and attach it again to AC power adaptor. The charge function starts when the CHARGE/REFRESH indicator flashes red.

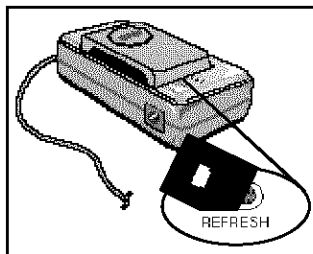

The time table of CHARGE, REFRESH and Continuous Recording time.

The recording time is affected by environmental temperatures and conditions.
The recording time becomes very short in a cold environment.

Battery Type	Charging		Continuous Recording Time		
	Not using REFRESH	Using REFRESH	SCA30	SCA33/A35	SCA80/A85
NC-120	Approx. 70 min.	Max. 6 hr.	95 min.	90 min.	80 min.
NH-170	Approx. 110 min.	Max. 9 hr.	140 min.	135 min.	125 min.
NH-180	Approx. 115 min.	Max. 9.5 hr.	145 min.	140 min.	130 min.
NC-240	Approx. 140 min.	Max. 12 hr.	190 min.	180 min.	160 min.
NH-340	Approx. 220 min.	Max. 18 hr.	280 min.	260 min.	240 min.

The battery pack supplied with the camcorder may be different depending on model number, region and retailer. (NC-120 for SCA30, NH-180 for SCA33/A35/A80/A85)

Preparing

Battery Level Display

✦ The battery level display indicates the amount of power remaining in the battery pack.

1. Fully charged
2. 10% consumed
3. 40% consumed
4. 80% consumed
(prepare a charged one)
5. 95% consumed
(change the battery)
6. 98% consumed
(camcorder will turn off soon, change the battery as soon as possible)

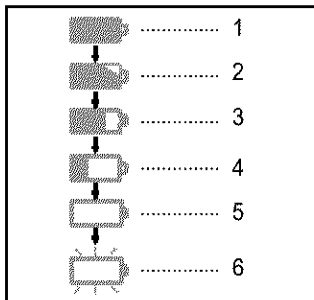

- ✦ The recording time of a fully charged battery is in the table on page 23.
- ✦ The recording time is affected by environmental temperature and conditions. The recording time becomes very short in a cold environment. The continuous recording time in the operating instructions is measured under the condition of using a fully charged battery pack at 77°F(25°C). As the environmental temperatures and conditions are different when you actually use the camcorder, the remaining battery time is not the same as the continuous recording time in the instructions.

Battery Charge Mark

A charge mark is provided on the battery pack to help you remember whether it has been charged or not.

Two colors are provided (red and black). You can select which one means charged and which means discharged.

Note: The charge mark does not affect the battery's charge status.

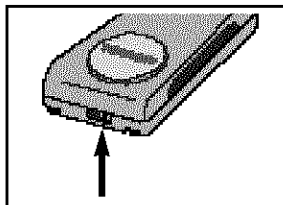

Preparing

Inserting and Ejecting a Cassette

- ✦ There are several cassette types, depending on the:
 - Color system used.
 - Recording/playback time.
 - Hi8/8mm (SCA80/A85: Hi8).

Inserting and Ejecting a Cassette

- ✦ Check that the battery pack is in place.
1. **Push the EJECT button.**
 - The compartment opens automatically.
 - Insert the cassette with the transparent window toward the outside and the protection tab toward the top.
 2. **Push the PUSH mark until the compartment clicks into place.**

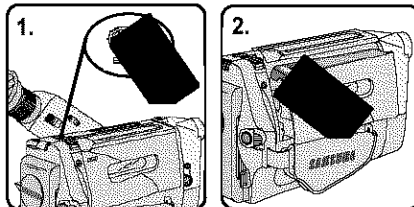

Note: When you have recorded a cassette that you wish to keep, you can protect it so that it will not be accidentally erased.

a. Recording Impossible (Protection):

Push the red tab on the cassette so that it covers up the opening.

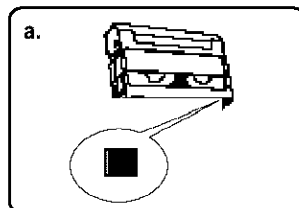

b. Recording possible:

If you no longer wish to keep the recording on the cassette, push the red tab back so that it no longer covers up the opening.

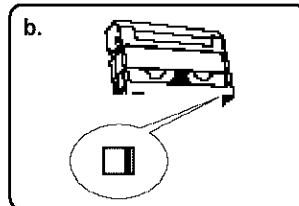

Basic Recording

Making your First Recording

Make sure that you make these preparations.

- Did you connect a power source? (Battery Pack or DC Cable) (see pages 21, 22)
- Did you set the POWER switch to the CAMERA position? (see page 21)
- Did you set the LOCK/STANDBY switch to STANDBY? (see page 21)
- Did you insert a cassette? (see page 25)
- Make sure that STBY is displayed in the OSD (if the red tab of the cassette is opened, STBY will not be displayed)
- Did you open the LENS CAP? (SCA30/A33/A80)
- The Lens Cap is opened automatically when you turn the Power switch to CAMERA position (SCA35/A85 only).
- Make sure the image you want to shoot appears in the viewfinder.
- Make sure the battery level indicates that there is enough remaining power for recording.

- a. To start recording, press the START/STOP button. Recording starts and REC is displayed on the viewfinder.

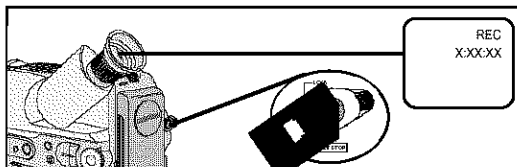

- b. To stop recording, press the START/STOP button again. Recording stops and STBY is displayed on the viewfinder.

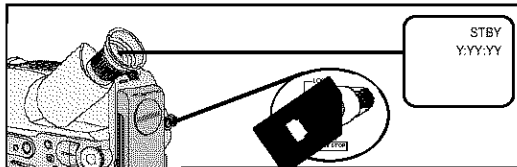

When a cassette is loaded and the camcorder is left in the STBY mode for over 5 minutes without being used, it will switch off automatically. To use it again, push the START/STOP button or set the POWER switch to OFF and then back to CAMERA. This Auto Power Off feature is designed to save battery power.

Edit Search

- ✦ You can view a recorded scene with E/SEARCH \oplus \ominus function in STBY mode. E/SEARCH \ominus enables you to reverse and E/SEARCH \oplus enables you to forward, for as long as you keep pressing.
- ✦ If you press and release the E/SEARCH \ominus button quickly in STBY mode, your camcorder will play back in reverse for 3 seconds and return to the original position automatically.

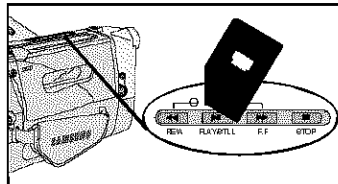

Basic Recording

Hints for Stable Image Recording

- ✦ While recording, it is very important to hold the camcorder correctly.
- ✦ If you're using model(s) SCA30/A33/A80, fix the LENS cap firmly by clipping it on the hand strap. (refer to figure)

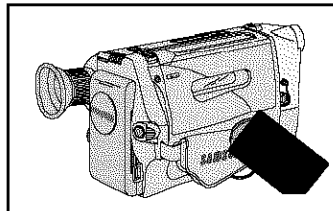

Recording with Viewfinder

1. Hold the camcorder firmly with the hand strap. (see page 20)
2. Place your right elbow against your side.
3. Place your left hand under the camcorder to support it. Be sure not to touch the built in microphone.
4. Choose a comfortable, stable position for the shots that you are taking. You can lean against a wall or on a table for greater stability. Do not forget to breathe gently.
5. Place your eye firmly against the viewfinder eyecup.
6. Use the viewfinder frame as a guide to determine the horizontal plane.
7. Whenever possible, use a tripod.

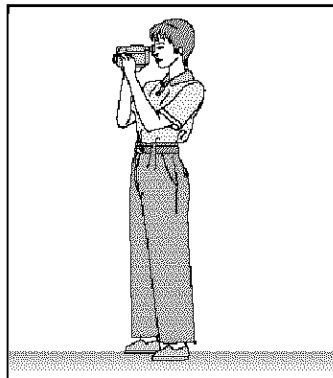

Basic Recording

Playing back a tape you have recorded on the Viewfinder

- ✦ You can monitor the playback picture on the viewfinder.
 - ✦ Make sure that the battery pack is in place.
1. While pressing the small red button on the POWER switch, set it to PLAYER position.
 2. Insert a tape you have just recorded.
 3. Make sure that STOP is displayed in the OSD.
 4. Press the ◀◀ (REW) button to rewind the tape to the start point.
 - To stop REWIND, press the ■ (STOP) button.
 - Camcorder changes to STOP mode automatically when the tape has reached it's end position after rewinding.
 5. Press the ▶▶ (PLAY/STILL) button to start playback.
 - To stop the PLAY operation, press the ■ (STOP) button.

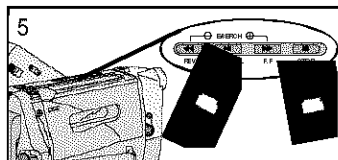
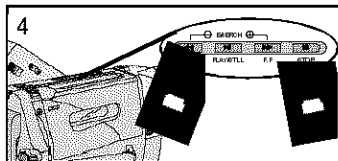
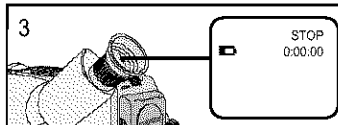
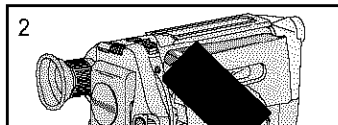
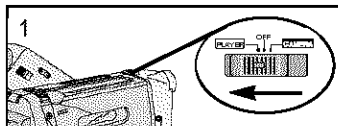

Note: You can also monitor the picture on a TV screen, after connecting the camcorder to a TV or VCR. (see page 45)

Basic Recording

Adjusting Focus and Brightness of the VIEWFINDER

Focus:

Turn the focus ring until the indicators displayed on the VIEWFINDER screen come into sharp focus.

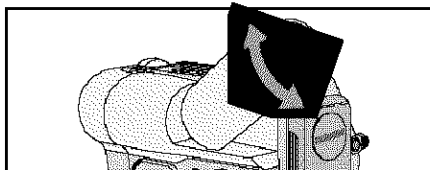

Brightness:

The VIEWFINDER brightness has been factory set. You can, however, alter this setting by using a small screwdriver to adjust the screw on the inner side of the VIEWFINDER.

If you experience problems adjusting the brightness, contact your local service center.

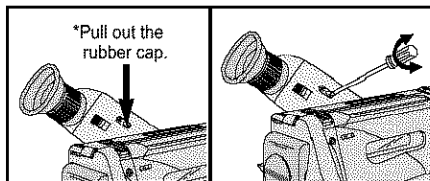

Viewing a Still Picture

- Press **▶||** (PLAY/STILL) button during playback.
- To resume playback, press the **▶||** (PLAY/STILL) button again.

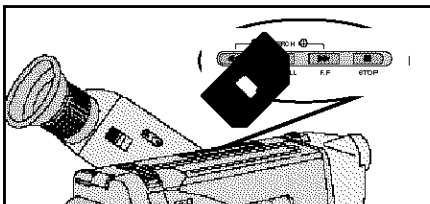

Picture Search

- Keep pressing **▶▶** (FF) or **◀◀** (REW) button during playback.
- To resume normal playback, release the button.

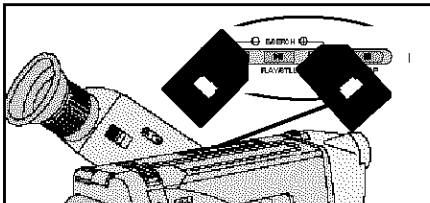

Advanced Recording

Setting a Function in CAMERA mode

- ✦ You can set the EIS ON/OFF, DEMO ON/OFF, DIGITAL ZOOM ON/OFF, PROGRAM AE, DSE, TITLE and CLOCK in CAMERA mode.

Setting the EIS ON/OFF

- ✦ The EIS feature is explained on page 34.
1. Set the camcorder to CAMERA mode. (see page 21)
 2. Press the MENU/ENTER button.
 - The MENU OSD is displayed.
 - The cursor shows the feature you can set.
 3. Rotate the MENU Dial to place the cursor over EIS ON/OFF.
 4. Press the MENU/ENTER button again.
 - You can change the setting.
 5. If you have finished the EIS setting.
 - Rotate the MENU Dial to place the cursor over EXIT.
 - Press the MENU/ENTER button again.
The MENU OSD is turned off.

Setting the DEMO ON/OFF

- ✦ You can view a demonstration of the main camcorder features using the DEMO function.
- ✦ The DEMO function is only available in CAMERA mode when you are not recording.

Note: If you press the START/STOP or MENU/ENTER button, the DEMO mode is turned off.

1. Set the camcorder to CAMERA mode. (see page 21)
2. Press the MENU/ENTER button.
3. Rotate the MENU Dial so as to place the cursor over DEMO ON/OFF.
4. Press the MENU/ENTER button again.
 - You can turn on the DEMO mode.
 - The DEMONSTRATION starts.
5. If you want to finish the DEMO mode, press the MENU/ENTER button again.
The DEMONSTRATION will stop.

Advanced Recording

Setting the DIGITAL ZOOM ON/OFF

- ✦ The DIGITAL ZOOM feature is explained on page 33.
- 1. Set the camcorder to CAMERA mode. (see page 21)
- 2. Press the MENU/ENTER button.
- 3. Rotate the MENU Dial so as to place the cursor over DIGITAL ZOOM ON/OFF.
- 4. Press the MENU/ENTER button again.
 - You can change the setting.
- 5. If you want to finish the DIGITAL ZOOM setting:
 - Rotate the MENU Dial to place the cursor over EXIT.
 - Press the MENU/ENTER button again. The MENU OSD is turned off.

Setting the Audio (SCA80/A85 only)

- ✦ The AUDIO STEREO/MONO function works in PLAYER mode only.
- ✦ This function enables you to select the audio output of your camcorder according to your TV system.
 - If you have a TV with stereo audio, set the AUDIO to STEREO.
 - If you have a TV with monaural audio, set the AUDIO to MONO.
- 1. Set the camcorder to STOP in PLAYER mode.
- 2. Press the MENU/ENTER button.
- 3. Rotate the MENU Dial to place the cursor over AUDIO STEREO/MONO.
- 4. Press the MENU/ENTER button again to change the setting as you want.
- 5. If you want to finish the function setting, place the cursor over EXIT and press the MENU/ENTER button.

DSE SELECT is explained on page 37.

TITLE SETTING is explained on pages 40, 41.

CLOCK SETTING is explained on pages 38, 39.

PROGRAM AE is explained on page 35.

Advanced Recording

Zooming In and Out

- ✦ Zoom works in CAMERA mode only.
- ✦ Zooming is a recording technique that lets you change the size of subject in the scene. For more professional looking recordings, use the zoom function sparingly.
- ✦ You can also select one of two zoom speeds according to your requirements:
 - Gradual zoom (9~12 seconds from TELE/WIDE to WIDE/TELE)
 - High-Speed zoom (3~6 seconds from TELE/WIDE to WIDE/TELE)
- ✦ Use these features to vary your shots; note, however, that too much zooming in and out tends to look unprofessional during playback and reduces the usage time of the battery pack.

1. Move the zoom lever a little for a gradual zoom, move it further for a high-speed zoom. Your zooming is monitored in the OSD.



2. **T(Telephoto) side:**
Subject appears closer.

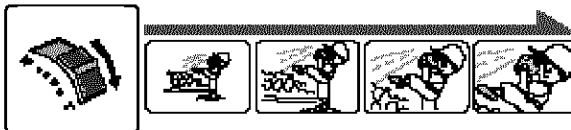

3. **W(Wide angle) side:**
Subject appears farther away.



Note: MACRO

If you cannot get a sharp focus while in extreme telephoto zoom, move the lever to the "W" side until the focus is sharp.

You can shoot a subject that is at least 1 mm away from the lens surface in the wide angle position.

Advanced Recording

Digital Zoom

- ✦ Zoom works in CAMERA mode only.
- ✦ Zooms more than 22x (SCA30/A33: 16x) are performed digitally.
- ✦ The picture quality deteriorates as you go toward the "T" side.
- ✦ We recommend that you use the EIS (SCA35/A85) feature with the DIGITAL ZOOM for picture stability. (see page 34)

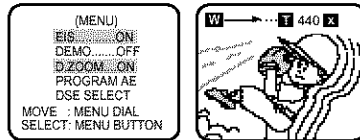

1. Set the camcorder to CAMERAmode. (see page 21)

2. Make sure that the DIGITAL ZOOM feature is set to on. (see page 31)

- SCA35/A80/A85: 440 x
- SCA30/A33: 320 x

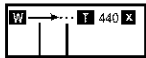
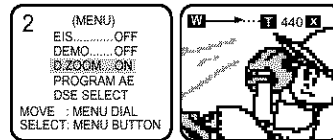

shows the digital zoom area
shows the optical zoom area

3. Move the ZOOM LEVER to the "T" side again.
The Digital zoom will operate.

4. If you do not want to use the digital zoom,
set the DIGITAL ZOOM function to OFF in the
MENU. (see page 31)

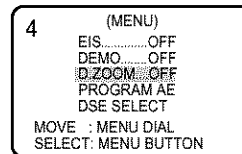

Advanced Recording

EIS (Electronic Image Stabilizer, SCA35/A85 only)

- ✦ The EIS function works in CAMERA mode only.
- ✦ The handshake compensation function, called EIS (Electronic image stabilizer) compensates for any slight shaking (within reasonable limits).
- ✦ It provides more stable pictures when:
 - Recording in the Zoom In mode
 - Recording a small object close-up
 - Recording and walking at the same time
 - Recording through the window of a vehicle

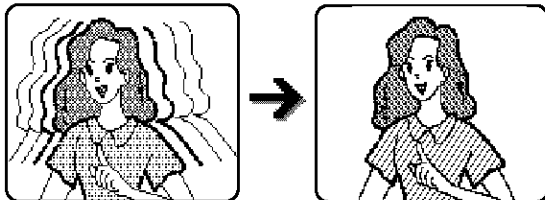





1. Set the camcorder to CAMERA mode. (See page 21)
2. Make sure that the EIS function is set to on. (see page 30)
If the EIS is set already, the EIS mark () is displayed in the OSD.
3. If you do not want to use the EIS function, set the EIS function to off in the MENU. (see page 30)

Note: It is recommended you deactivate the handshake compensation function when using a tripod.

Advanced Recording

PROGRAM AE (Automatic Exposure)

- ✦ The PROGRAM AE function works in CAMERA mode only.
 - ✦ The PROGRAM AE modes enable you to adapt the shutter speed and aperture to the type of scene to be shot. They give you creative control over the depth of field.
 - ✦ There are 6 automatic exposure modes.
- a. AUTO mode**
- Auto balancing between the subject and the background.
 - To be used in normal conditions.
 - The shutter speed automatically varies from 1/60 to 1/250 second, depending on the scene.
- b. SPORTS mode ()**
- For recording people or objects moving quickly; you will be able to play back the picture in slow motion on an 8 mm VCR or stop on a given image with very little blur.
- C. PORTRAIT mode ()**
- For focusing on the foreground subject, the background being out of focus.
The PORTRAIT mode is most effective when used outdoors.
 - The shutter speed automatically varies from 1/60 to 1/1000 second, depending on the scene.
- d. SPOTLIGHT mode ()**
- To shoot correctly when there is only light on the subject and not the rest of the scene.
 - The shutter speed is 1/60 second.
- e. SAND/SNOW mode ()**
- For shooting when the people or objects are darker than the background because of reflected light from sand or snow.
 - The shutter speed automatically varies from 1/60 to 1/250 second, depending on the scene.
- f. HSS (High Speed Shutter) mode ()**
- For shooting fast-moving subjects such as the players in golf or tennis games.
 - The shutter speed is fixed to 1/10,000 second.
 - You may need to light the shooting area.

Setting the PROGRAM AE

1. Set the camcorder to CAMERA mode. (see page 21)
2. Press the MENU/ENTER button.
3. Rotate the MENU Dial so as to place the cursor over PROGRAM AE.
4. Press the MENU/ENTER button again.
 - PROGRAM AE modes are displayed.
5. Rotate the MENU Dial to change the PROGRAM AE mode.
6. Press the MENU/ENTER button again.
 - A PROGRAM AE mode you had selected is displayed.
7. If you want to finish the PROGRAM AE setting:
 - Rotate the MENU Dial to place the cursor over EXIT.
 - Press the MENU/ENTER button again. The MENU OSD is turned off.

Advanced Recording

Fade In and Out

- ✦ The FADE function works in CAMERA mode only.
- ✦ To give a professional look to your films, you can use a few special effects, such as fading in and out at beginning or end of a sequence.

Starting Recording

1. Before recording, hold down the FADE button.
The picture and sound gradually disappear (fade out).
2. Press the START/STOP button and at the same time release the FADE button.
Recording starts and the picture and sound gradually appear (fade in).

Stopping Recording (use FADE IN → FADE OUT)

3. When you wish to stop recording, hold down the FADE button.
The picture and sound gradually disappear (fade out).
4. When the picture has disappeared, press the START/STOP button to stop recording.

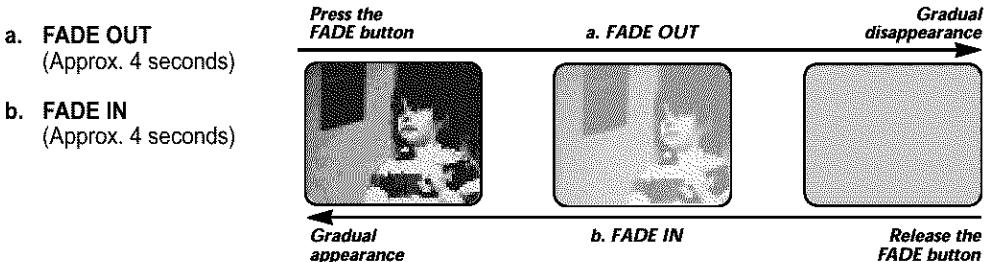
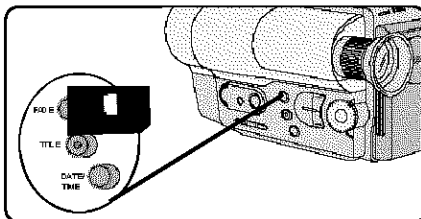

Advanced Recording

Creative DSE (Digital Special Effects)

- ✦ The digital effects enable you to give a creative look to your recordings by adding various special effects.
- ✦ Select the appropriate digital effect for the type of scene that you wish to shoot and the effect that you wish to give.
- ✦ There are 7 DSE modes.

1. Normal picture
2. MAKE-UP
3. EMBOSS
4. WIDE (16:9)
5. CINEMA
6. NEG. (Negative)
7. MIRROR
8. MOSAIC

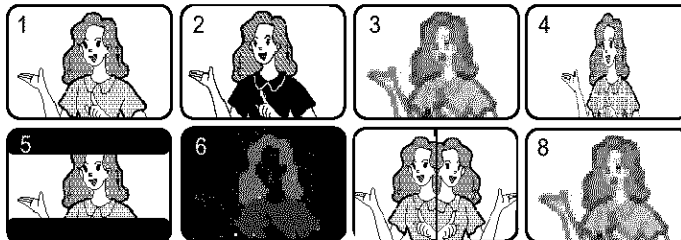

Selecting an effect

1. Set the camcorder to the CAMERA mode. (see page 21)
2. Press the MENU/ENTER button.
3. Rotate MENU Dial so as to place the cursor in the DSE SELECT.
4. Press the MENU/ENTER button.
 - DSE modes will be displayed.
5. Rotate MENU Dial to select an effect.

Example: The MAKE-UP mode enables you to give a cosmetic effect to the scene.

- If you select MAKE-UP, you must select a color mode. (modes are RED, YELLOW, GREEN, BLUE)
6. Press the MENU/ENTER button.
 7. If you want to finish the DSE SELECT.
 - Rotate MENU Dia to place the cursor over EXIT.
 - Press the MENU/ENTER button.

Recording a DSE in CAMERA mode

1. Set the camcorder to STANDBY in CAMERA mode. (see page 21)
2. Press the START/STOP button.
 - Recording will start.
3. Press the DSE button during recording to record an effect you have selected.
 - The effect you have selected appears.
4. To return to normal, press the DSE button again.

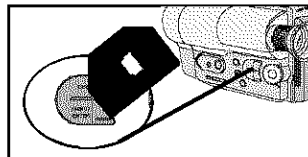

Note: If you use the WIDE or MIRROR features, the EIS feature will not work.

Advanced Recording

Setting and Recording a DATE/TIME

- ✦ Setting and recording the date/time feature works in CAMERAmode only.
- ✦ You can record the date/time on the tapes that you make, so that when you view the tape at a later date, you will be reminded of when it was made. The date and time are recorded whenever they are displayed in the viewfinder.

Setting a DATE/TIME

- ✦ Setting a date/time works in STANDBY of CAMERA mode only.
1. Make sure that you have installed the LITHIUM BATTERY. (see page 20)
The LITHIUM BATTERY is needed to maintain the clock. (see page 22)
 2. Set the camcorder to STANDBY in CAMERA mode. (see page 21)

3. Press the MENU/ENTER button.
 - The MENU OSD is displayed.
 - The cursor shows the feature you can set.
4. Rotate the MENU Dial so as to place the cursor over CLOCK SETTING.
5. Press the MENU/ENTER button again.
 - The current setting is displayed and the year flashes.
 - Rotate the MENU Dial to change the year setting.
6. Press the MENU/ENTER button when the correct year is set.
 - The month flashes.
 - Rotate the MENU Dial to change the month setting as you desire.

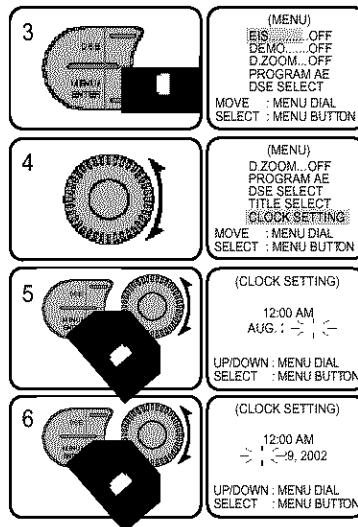

Advanced Recording

7. Press the MENU/ENTER button when the correct month is set.
- The day flashes.
 - Rotate the MENU Dial to change the day setting.



8. Enter the hour and minute in the same way.

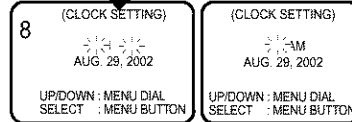

9. To finish Date/Time setting, press the MENU/ENTER button after setting the minute.



Recording a DATE/TIME

1. Make sure that you have set the DATE/TIME. (see page 38)
2. Set the camcorder to STANDBY in CAMERA mode. (see page 21)
3. Press the DATE/TIME button.
 - To record the date only, press the DATE/TIME button once.
 - To record the date and time, press the DATE/TIME button twice.
4. Press the START/STOP button to record date/time with your scene.

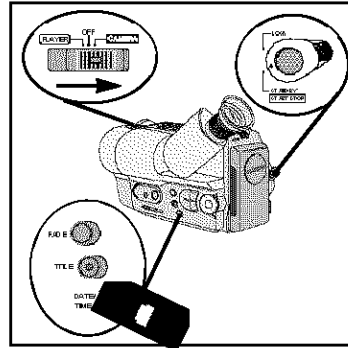

Note:

- If your date and time settings are not maintained in camcorder, it means the installed LITHIUM BATTERY is discharged. (see page 20)
- You cannot conceal the recorded date or time during playback.

Advanced Recording

Selecting and Recording a Title

- ✦ Selecting and recording a TITLE works in CAMERA mode only.
- ✦ The TITLE generation feature enables you to select a preset title stored in the camcorder's memory.
- ✦ You can also select the language of the titles.

Selecting a Language

- ✦ Selecting a language works in STANDBY in CAMERA mode only.
 - ✦ The factory default language is ENGLISH.
You can change the language.
1. Make sure that you have installed the LITHIUM BATTERY. (see page 20)
 2. Set the camcorder to STANDBY in CAMERA mode. (see page 21)
 3. Press the MENU/ENTER button.
 - The MENU OSD is displayed.
 - Rotate the MENU Dial so as to place the cursor over TITLE SELECT.
 4. Press the MENU/ENTER button.
 - Rotate the MENU Dial so as to place the cursor over LANGUAGE SELECT.
 5. Press the MENU/ENTER button.
 - The languages you can select are displayed.
 - ENGLISH
 - FRENCH
 - GERMAN
 - ITALIAN
 - SPANISH
 - RUSSIAN
 - Rotate the MENU Dial to select the language you want.
 - Press the MENU/ENTER button.

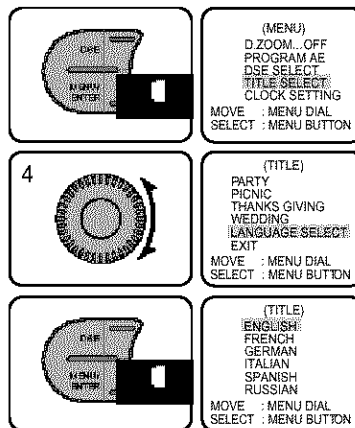

Advanced Recording

Selecting a Title

6. Rotate the MENU Dial to select the desired item.

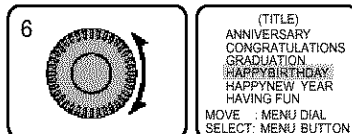

7. Press the MENU/ENTER button.

- The MENU disappears and the title you have selected is displayed.

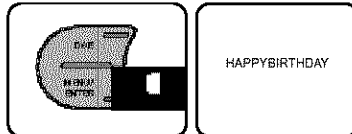

Recording a Title

1. Make sure that you have selected a TITLE.
2. Set the camcorder to STANDBY in CAMERAmode. (see page 21)
3. Press the TITLE button.
 - The title you selected is displayed.
4. Press the START/STOP button to record the title with your scene.
5. Press the title button again if you do not want to record the title.

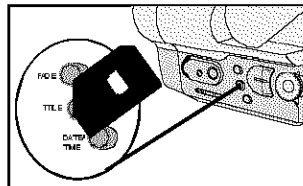

Note: The title moves horizontally from the right side to the left side 10 seconds after you start recording.

I-BLC/BLC (BLC for SCA30)

I-BLC or BLC works in CAMERA mode.

Back lighting exists when the subject is darker than the background:

- The subject is placed in front of a window.
- The person to be recorded is wearing white or shiny clothes and is placed against a bright background; the person's face is too dark to distinguish their features.
- The subject is outdoors and the background is an overcast sky.
- The light sources are too bright.
- The subject is against a snowy background.

1. Set the camcorder to CAMERA mode. (see page 21)
2. Press the I-BLC/BLC(BLC for SCA30) button.
 - Normal - I-BLC - BLC - Normal
 - Normal - BLC - Normal (SCA30)
 - I-BLC enhances the subject and background.
 - BLC enhances only the subject.

* I-BLC or BLC off

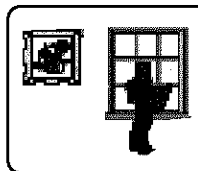

* I-BLC or BLC on

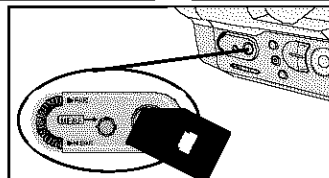

Note: If you set a PROGRAM AE besides AUTO, the I-BLC/BLC will not work.

Advanced Recording

MF/AF (Manual Focus/Auto Focus)

- ✦ The MF/AF function works in CAMERA mode only.
- ✦ In most situations, it is better to use the Automatic Focus feature, as it enables you to concentrate on the creative side of your recording.
- ✦ Manual focusing is made necessary by certain conditions, for which automatic focusing is inadequate.

Auto Focusing

- ✦ The AF (Auto Focus) mode is set automatically when you switch on the camcorder.
- ✦ If you are inexperienced with camcorders, we recommend that you use the Auto Focus mode.

Manual Focusing

- ✦ In the following situations you should obtain better results by adjusting the focus manually.

- a. A picture containing several objects, some close to the camcorder, others further away.
- b. A person enveloped in fog or surrounded by snow.
- c. A person behind a window.
- d. Very shiny or glossy surfaces like a car.
- e. Conditions in which there is a strong contrast between the right and left-hand parts of the picture.
- f. People or objects moving constantly or quickly like an athlete or crowd.



1. Set the camcorder to CAMERA mode. (see page 21)
2. Press the MF/AF button.
3. Zoom In the subject to be shot by pushing the ZOOM tab to the "T" side.
4. Turn the manual focus dial in the appropriate direction until the subject comes into sharp focus.
5. You will obtain a sharp picture after you zoom out.
6. To return to AF(Auto Focus), press the MF/AF button again.

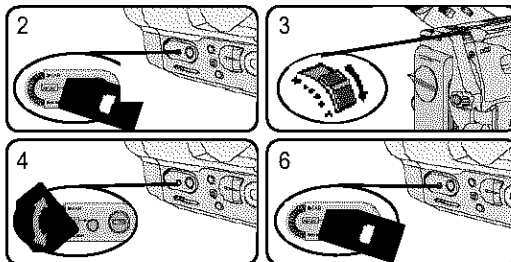

Advanced Recording

Using the VIDEO LIGHT (SCA35/A85 only)

- ✦ The VIDEO LIGHT works in CAMERAmode only.
- ✦ To brighten the scene when natural lighting is too dim.

Danger:

- The video light can become extremely hot. Do not touch it either while in operation or soon after turning it off, otherwise serious injury may result.
- Do not place the camcorder into the carrying case immediately after using the video light, since it can remain extremely hot for some time.
- Do not use near flammable or explosive materials.
- It is recommended that you consult your nearest SAMSUNG dealer for bulb replacement.

1. Set the camcorder to CAMERAmode.
2. Press the VIDEO LIGHT button.
 - The LIGHT display () appears in the monitor, and the light is turned on.
3. If you wish to turn off the LIGHT, press the VIDEO LIGHT button again.

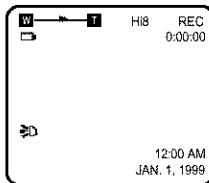
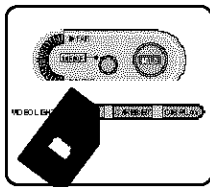

Notes:

- The LIGHT is turned off automatically during EJECTING or TAPE INSERTING.
 - Even if the battery indicator () does not blink when the battery pack's charge is low, the camcorder may turn off automatically when you turn on the LIGHT, or when you start recording with LIGHT turned on.
 - The built-in light is used as a subsidiary light, it may not be powerful enough for outdoor lighting.
- ✦ The life of the bulb is approximately 50 hours.
- The life of the bulb is shortened when you use the VIDEO LIGHT with AC Power Adaptor as an indoor power source.
(AC Power Adaptor: 7V approx., Battery Pack: 6V approx.)

Advanced Recording

Lighting Techniques

- ✦ When you use your camcorder, there are two main situations.
 - You will be shooting outdoors (Normal recording or use of a ND(Neutral Density) filter).
 - You will be shooting indoors (Video light recommended or required).
- ✦ The single greatest influence on picture quality is the level of brightness, measured in lux.
- ✦ The following table lists a few common situations, the corresponding level of brightness and any associated recommendations.

Situations	Brightness (lux)	Recommendations
<ul style="list-style-type: none"> ◆ Snow-covered mountains or fields. ◆ Sandy beach on a hot summer's day. 	100,000	ND filter recommended.
<ul style="list-style-type: none"> ◆ Sunny around midday. ◆ Sunny day in the middle of the afternoon. ◆ Overcast day around midday. ◆ Overcast day one hour after sunrise. ◆ Office with fluorescent lighting near to a window. ◆ Sunny day one hour before sunset. ◆ Department store counter. ◆ Station ticket counter. 	100,000 35,000 32,000 2,000 1,000 1,000 500 to 700 650	Normal recording.
<ul style="list-style-type: none"> ◆ Office with fluorescent lighting. ◆ Room lit by two 30W fluorescent lights. 	400 to 500 300	Video light recommended.
<ul style="list-style-type: none"> ◆ Arcade at night. ◆ Theater (theatre) lobby. ◆ Candle light. 	150 to 200 15 to 30 10 to 15	Video light required.

After recording

1. Eject a tape you have recorded. (see page 25)
2. If you want to protect accidental erasure of a tape you have recorded, push the red tab on the cassette.
3. Set the POWER switch to OFF.
 - The LENS cover automatically closes when the camcorder turns OFF. (SCA35/A85)
4. Close the LENS cover. (SCA30/A33/A80)
5. Remove the BATTERY PACK from the camcorder.

Playing back a Tape

- ✦ To watch a tape you recorded.
- ✦ Playback function works in PLAYER mode only.
- ✦ There are two ways to watch a tape;
 - To watch with viewfinder: recommended for outdoor use.
 - To watch with TV monitor: recommended for indoor use.

To watch with viewfinder

- ✦ It is practical to view a tape using the viewfinder in a car or outdoors.

To watch with TV monitor

- ✦ It is practical to view a tape using a TV monitor while indoors.
- ✦ To play a tape back, the TV must feature a compatible color system.
- ✦ We recommend that you use an AC power adaptor for the power source of the camcorder.

Connecting to a TV which has an Audio and Video input jack

- ✦ Use the Audio/Video cable supplied with your camcorder.
 - The yellow plug: Video
 - The white plug: Audio(L)
 - The red plug: Audio(R) (STEREO only)
(SCA30/A33/A35: Monaural, SCA80/A85: Stereo)

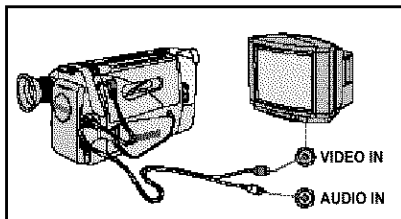

Connecting to a TV which has no Audio and Video input jack

- ✦ You can connect your camcorder to a TV through a VCR.
 - The yellow plug: Video
 - The white plug: Audio(L)
 - The red plug: Audio(R) (STEREO only)
(SCA30/A33/A35: Monaural, SCA80/A85: Stereo)
- ✦ To view the cassette on the television screen, select the channel reserved for your VCR on the television. (Refer to your VCR or television instruction book.)

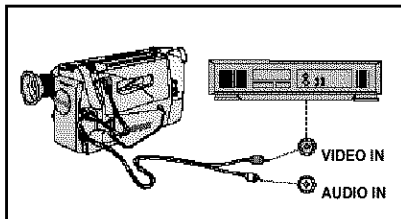

Notes:

- SCA30/A33/A35 feature a monaural audio system.
If your TV or VCR features a stereo audio system, connect the audio cable to input "L" of your TV or VCR.
- If you have SCA80/A85, you can use the S-VIDEO cable (supplied with the SCA80/A85) to obtain better quality pictures if you have a S-VIDEO connector on your TV.

Playing back a Tape

Playing Back the Camcorder

1. Use the TV/VIDEO button to select VIDEO on your TV.
2. Connect a power source (battery or AC power adaptor) to the camcorder.
Set the POWER switch to PLAYER.
3. Insert a tape you want to see.
 - Make sure that STOP is displayed.
4. Press the ►|| (PLAY/STILL) button.
 - The picture you recorded appears on the TV after 2 to 3 seconds.
 - If the tape reaches its end during playback, the tape will rewind automatically.

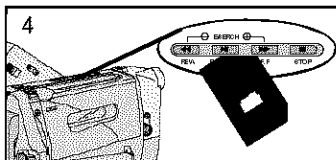
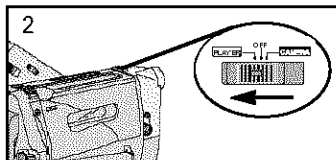

- Note:**
- The play back mode (SP/LP) and system (Hi8/8mm) are selected automatically, depending on the tape format.
 - SCA80/A85 can play back both Hi8 and 8mm.

Various Functions in PLAYER mode

To view a STILL picture (Playback pause)

- Press ►|| (PLAY/STILL) button during playback.
- To resume playback, press ►|| (PLAY/STILL) button again.

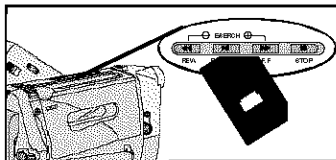

- Note:** To prevent tape and head-drum wear, your camcorder will automatically STOP if it is left for more than 5 minutes in STILL mode without operation.

To locate a scene (picture search)

- Press ►► (FF) or ◀◀ (REW) buttons during playback. To resume normal playback, release the buttons.

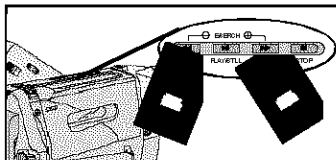

Playing back a Tape

Zero Return

- ✦ The ZERO RETURN function works in STOP of PLAYER mode.
- ✦ You can Fast Forward or Rewind to 0:00:00 on the TAPE COUNTER automatically.

1. Set the POWER switch to PLAYER.
 - Make sure that STOP is displayed.
2. Press the ZERO RETURN button.
 - Z.RTN is displayed.
 - FF or REW starts automatically and stops at 0:00:00.

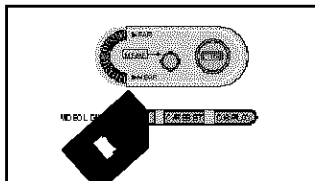

Note: The Z.RTN button does not work when the TAPE COUNTER reads 0:00:00.

- Note:**
- Press the C/RESET button to set the TAPE COUNTER to 0:00:00 at the start of the cassette or the required sequence.
 - When you wish to find the 0:00:00 point on the tape again, press Z.RTN button when playback is stopped.

Setting Audio in the PLAYER mode (SCA80/85 only)

1. Set the camcorder to STOP in PLAYER mode.
2. Press the MENU/ENTER button.
3. Rotate MENU Dial to place the cursor in the function you want to set.
4. Press the MENU/ENTER button to set the function.
5. If you want to finish the function setting, rotate MENU Dial so as to the cursor over EXIT and press the MENU/ENTER button.

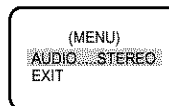

SCA80/A85

Maintenance

Cleaning and Maintaining the Camcorder

Cleaning the Viewfinder

◆ Releasing the Eyecup

1. While sliding the RELEASE knob, turn the eyecup in the direction of the arrow and pull it out.
2. Clean the eyecup and viewfinder screen with a soft cloth and a cotton tipped stick or a blower.

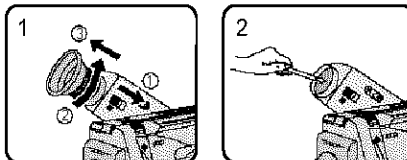

◆ Reattaching the Eyecup

3. Align the groove on the eyecup with the (↻) mark on the barrel.
4. Turn the eyecup in the direction of the arrow until it clicks into place.

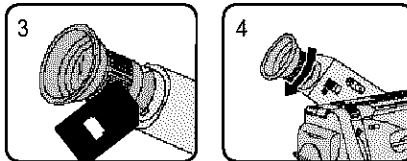

Cleaning the Video Heads

- ◆ To ensure normal recording and clear pictures, clean the video heads.
- ◆ When the playback pictures are noisy or hardly visible, the video heads may be dirty.

- a. Normal Picture
- b. Noisy Picture
If this happens, clean the video heads with a dry type cleaning tape.

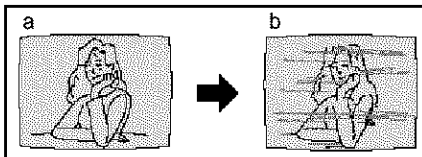

1. Set the POWER switch to PLAYER.
2. Insert a cleaning tape.
3. Press the ►|| (PLAY/STILL) button.
4. Press the ■ (STOP) button after about 30 seconds.

Check the quality of the picture using a video cassette. If it is still poor, repeat the operation. If the problem continues, contact your local authorized service center.

Maintenance

Storing the Camcorder

1. You must detach the BATTERY PACK from the camcorder when storing.
2. Keep the camcorder in a ventilated, dry and warm place.
3. Do not keep the camcorder in a place where the temperature varies greatly, such as in a car.
4. Keep the camcorder in a stable place.

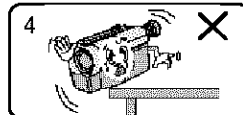
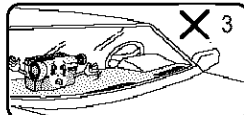
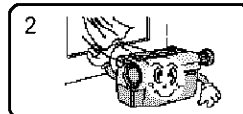
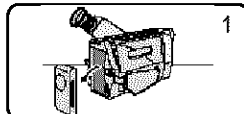

Using Your Camcorder Abroad

- ✦ Each country or area has its own electric and TV color system.
- ✦ Before using your camcorder abroad, check the following points.

Power sources

- You can use your camcorder in any country or area with the supplied AC power adaptor within 100V to 240V, 50/60 Hz.
- Use a commercially available AC plug adaptor, if necessary, depending on the design of the local wall outlet.

Color system

- You can view your recording in the viewfinder. However, to view it on a television or copy it to a video cassette recorder, the television or VCR must be NTSC-compatible and have the appropriate audio/video jacks. Otherwise, you may need to use a transcoder.

✦ PAL-compatible area

Australia, Austria, Belgium, Bulgaria, China, CIS, Czech Republic, Denmark, Egypt, Finland, France, Germany, Greece, Great Britain, Holland, Hong Kong, Hungary, India, Iran, Iraq, Kuwait, Libya, Malaysia, Mauritius, Rumania, Saudi Arabia, Singapore, Slovak Republic, Spain, Sweden, Switzerland, Syria, Thailand, Tunisia, etc.

✦ NTSC-compatible area



Bahamas, Canada, Central America, Japan, Mexico, Philippines, Korea, Taiwan, United States of America, etc.

Note: You can make recordings with your camcorder anywhere in the world.

Troubleshooting

- ✦ Before contacting a service center, perform the following simple checks. They may save you the time and expense of an unnecessary call.

Self Diagnosis Display

Display	Blinking	Inform that...	Action
	slow	the battery pack is almost discharged	Change to a charged one.
	fast	the battery pack is fully discharged.	Change to a charged battery.
TAPE	slow	the tape has almost reached its end.	Prepare a new one.
TAPE END	no	the tape reached its end	Change to a new one.
TAPE	slow	there is no tape in camcorder.	Insert a tape.
TAPE	slow	the tape is protected to record.	If you want to record, release the protection.
D.EMG C.EMG R.EMG L.EMG	slow	the camcorder has some mechanical fault.	1. Eject the tape. 2. Set to OFF. 3. Detach the battery. 4. Reattach the battery. * If repeated contact local service.
DEW	slow	moisture condensation has formed in the camcorder.	see below.

Moisture Condensation

- ✦ If the camcorder is brought directly from a cold place to a warm place, moisture may condense inside the camcorder, on the surface of the tape, or on the lens. In this condition, the tape may stick to the head drum and be damaged or the unit may not operate correctly.
To prevent possible damage under these circumstances, the camcorder is furnished with moisture sensor.
- ✦ If there is moisture inside the camcorder, "DEW" is displayed.
If this happens, none of the functions except cassette ejection will work.
Open the cassette compartment and remove the battery. Leave the camcorder in a dry, warm room for at least two hours.
- ✦ If the DEW protection is activated unexpectedly, see page 5.

Troubleshooting

Troubleshooting

- ✦ If you run into any problem using the camcorder, use the following table to troubleshoot the problem.
- ✦ If these instructions do not allow you to solve the problem, take a note of:
 - The model and serial number marked on the bottom of the camcorder.
 - Your warranty, if applicable.
- ✦ Then contact your nearest authorized service center.

Symptom	Explanation/Solution
You cannot switch the camcorder on.	<ul style="list-style-type: none"> • Check the battery pack (see page 22) or the AC power adaptor. (see page 21)
Start/Stop does not operate while shooting	<ul style="list-style-type: none"> • Check the POWER and LOCK/STANDBY switches, set to CAMERA and STANDBY. • You have reached the end of the cassette. • Check the record protection tab on the cassette. (see page 25)
The camcorder goes off automatically.	<ul style="list-style-type: none"> • You have left the camcorder set to STANDBY for more than 5 minutes without using it. (see page 7) • The battery pack is fully exhausted. (see page 24)
The battery pack is quickly exhausted.	<ul style="list-style-type: none"> • The atmospheric temperature is too low. (see page 24) • The battery pack has not been charged fully. (see page 23) • The battery pack is completely dead, and cannot be recharged. Use another battery pack.
You cannot eject the cassette from the compartment.	<ul style="list-style-type: none"> • The battery pack is exhausted fully. • A mechanical fault may have occurred. (see page 50)
The DATE/TIME indicator flashes more than 2 times when you set the camcorder to CAMERA.	<ul style="list-style-type: none"> • The lithium battery is not installed or exhausted fully. (see page 20)
The playback picture is of poor quality.	<ul style="list-style-type: none"> • The video heads may be dirty. (see page 48)
You can do nothing with the camcorder.	<ul style="list-style-type: none"> • A mechanical fault may have occurred. (see page 50)

Troubleshooting

Symptom	Explanation/Solution
A vertical strip appears when you shoot a bright subject against a dark background (candle flame, for example)	<ul style="list-style-type: none">• The contrast between the subject and the background is too great for the camcorder to operate normally. Make the background bright to reduce the contrast or use the I-BLC/BLC function while you are shooting. (see page 41)
The image in the viewfinder is blurred.	<ul style="list-style-type: none">• The viewfinder lens has not been adjusted. Turn the viewfinder focus ring until the indicators displayed on the viewfinder screen come into sharp focus.
The tape does not move when you press the Play, Fast Forward or Rewind buttons.	<ul style="list-style-type: none">• Set the POWER switch to PLAYER.• You have reached the beginning or end of the cassette.
The Date/Time or Title disappeared even though they were set.	<ul style="list-style-type: none">• The lithium battery is not installed or is exhausted fully. (see page 20)

Specifications

Specifications

- ✦ The technical specifications and design may be changed without notice.

System	SCA30/A33/A35/A80/A85
Recording system	Video: 2 rotary heads helical scanning FM Audio: FM monaural system (SCA80/A85: FM stereo)
Video signal	NTSC color, EIA standard
Usable cassette	SCA30/A33/A35: 8 mm SCA80/A85: Hi8 or 8 mm
Tape speed	SP: approx. 14.345 mm/sec
Speed mode	Record: SP only Playback: SP and LP
Recording time	P6-120: 120 min
FF or REW time	P6-120: approx. 6.5 min.
Image device	CCD (Charge Coupled Device)
Optical zoom ratio	SCA30/A33: 16X SCA35/A80/A85: 22X
Focal length: f	SCA30/A33: 3.9~62.6 mm SCA35/A80/A85: 4.0~88.0 mm
F	SCA30/A33: 1.4 SCA35/A80/A85: 1.6
Filter diameter	46 mm
Focus system	Inner
Macro	Auto wide macro
Min. Illumination	0.3 lux (visible)
Connectors	
Video out	Mini jack, 1 Vp-p, 75 ohms Unbalanced
Audio out	Mini jack, 7.7 dBs, Monaural (SCA80/A85: stereo) imp.: less than 2.2 kohms
External mic	Monaural (SCA80/A85: stereo), Ø3.5
General	
Power requirement	6.0~7.2 V DC
Power consumption	SCA30: 3.9 W SCA33: 4.1 W SCA35: 4.2 W SCA80: 4.7 W SCA85: 4.8 W
Built-in mic	Condenser mic, omni-directional
Operating temperature	0°C to 40°C (32°F to 104°F)
Dimensions (W*H*D)	SCA35/A80/A85 : 105.7*104.5*210 (41.6*41.1*82.7 inch) SCA30/A33 : 105.7*104.5*201 (41.6*41.1*79.1 inch)
Weight	SCA35/A80/A85: 760 g (1.672 lbs) SCA30/A33: 740g (1.628 lbs)

Index

- A -

ABROAD	49
AC POWER ADAPTOR	21
ADJUSTING	29
AF	42
AUDIO	45
AUTO FOCUSING	42
AUTO MODE	35
AUTO POWER OFF	26

- B -

BATTERY	22
BATTERY EJECT	22
BATTERY LEVEL	24
BATTERY PACK	22
BLC	41
BRIGHTNESS	29

- C -

CAMERA	21
CASSETTE	25
CASSETTE HOLDER	15
CHARGING	22
CLEANING	48
COMPENSATION	41
CONTENTS	2, 3
COUNTER	13, 17

- D -

DATE	38
DATE/TIME	38
DC CABLE	21
DEMO	30
DEW	5, 50
DIGITAL ZOOM	33
DIMENSIONS	53
DISCHARGE	23
DISPLAY	16
DSE	37

- E -

E/SEARCH	26
EIS	34
EJECT	25
EMBOSS	37
ENTER	30
EXIT	35
EXTERNALMIC	53
EYECUP	48

- F -

FADE IN	36
FADE OUT	36
FF (FAST FORWARD)	46
FILTER DIAMETER	53
FOCALLENGTH	53

- H -

HAND STRAP	20
Hi8	25

- I -

I-BLC	41
IMAGE DEVICE	52

- L -

LENS	53
LENS CAP	27
LIGHTING	43
LITHIUM BATTERY	20
LOCK	21

- M -

MACRO	12, 32
MAINTAINING	48
MAKE-UP	37
MENU	30
MF(MANUAL FOCUS)	42
MIC	53
MIRROR	37

Index

MOISTURE	5, 50	SPECIFICATIONS	53
MONAURALAUDIO	53	SPORTS MODE	35
MOSAIC	37	SPOTLIGHT MODE	35
- N -			
ND FILTER	44	STANDBY	26
NEG.	37	START/STOP	26
NTSC	49	STILL	46
- O -			
OPERATION MODE	17	STOP	26
OSD	16	SYSTEM	53
- P -			
PAL	49	- T -	
PICTURE SEARCH	46	TAPE COUNTER	47
PLAY	46	TAPE EJECT	25
PLAYER	46	TAPE END	50
PLAYING BACK	46	TIME	38, 39
PORTRAIT MODE	35	TITLE	40
POWER CONSUMPTION	53	TROUBLESHOOTING	51, 52
POWER REQUIREMENT	53	TV MONITOR	45
POWER SWITCH	28	- U -	
PROGRAM AE	35	USABLE CASSETTE	53
- R -			
RECORDING	26	- V -	
RECORDING TIME	23	VIDEO	45
REFRESH	23	VIDEO HEAD	48
REMOTE CONTROL	19	VIDEO LIGHT	43
REW (REWIND)	46	VIEWFINDER	28
- S -			
SAFETYINSTRUCTIONS	4	- W -	
SAND/SNOW MODE	35	WAIT-10S	19
SELF-30S	19	WEIGHT	53
SELF-END	19	WIDE (16:9)	37
SELF DIAGNOSIS	50	WINDOW	25
SELF RECORD	19	- Z -	
SELF TIMER	19	ZERO RETURN	47
SHOULDER STRAP	20	ZOOM	32

Warranty

SAMSUNG LIMITED WARRANTY

SAMSUNG Electronics America Inc. (SEA), warrants that this product is free from defective material and workmanship.

SEA further warrants that if product fails to operate properly within the specified warranty period and the failure is due to improper workmanship or defective material, SEA will repair or replace the product at its option.

All warranty repairs must be performed by a SEA authorized service center. The name and address of the location nearest you can be obtained by calling toll free: 1-800 SAMSUNG (1-800-726-7864).

Labor

90 days carry-in

Parts

1 year

On carry-in models, transportation to and from the service center is the customer's responsibility.

The original dated sales receipt must be retained by the customer and is the only acceptable proof of purchase. It must be presented to the authorized service center.

EXCLUSIONS (WHAT IS NOT COVERED)

This warranty does not cover damage due to accident, fire, flood and/or other acts of God; misuse, incorrect line voltage, improper installation, improper or unauthorized repairs, commercial use, or damage that occurs in shipping.

Exterior and interior finish, lamps, and glass are not covered under this warranty.

Customer adjustments which are explained in the instruction manual are not covered under the terms of this warranty. This warranty will automatically be voided for any unit found with a missing or altered serial number. This warranty is valid only on products purchased in the United States and Puerto Rico.

Some States do not allow the exclusions or limitations of incidental or consequential damages, or allow limitations on how long an implied warranty lasts, so the above limitations or exclusions may not apply to you. This warranty gives you specific legal rights, and you may also have other rights which vary from State to State.

THIS CAMCORDER IS MANUFACTURED BY:

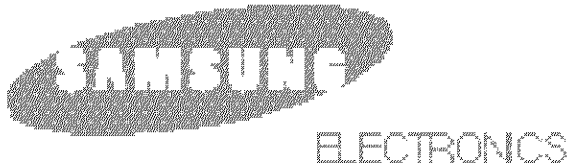

SAMSUNG Electronics America Inc.
105 Challenger Road Ridgefield Park N.J 07660-0511
Tel: 1-800-SAMSUNG
(1-800-726-7864)

*Samsung Electronics'Internet Home Page
<http://www.sosimple.com>

AD68-00012C