

KOHLER® Command PRO

CH245, CH255, CH260, CH270, CH395,
CH395DF, CH395TF, CH440, CH440DF

Owner's Manual

EN
ESS
FRC
ID
KO
ZH

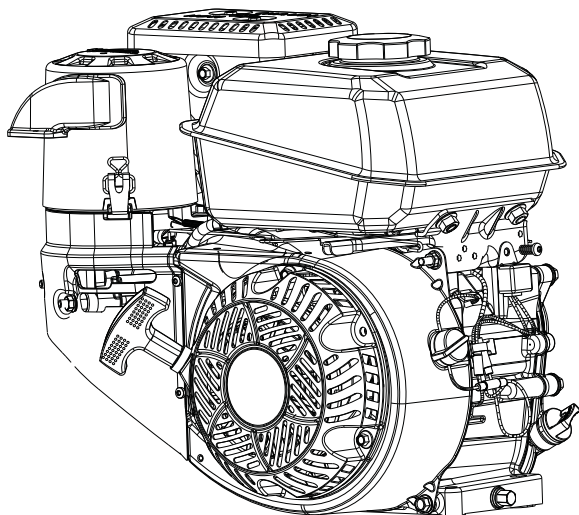

IMPORTANT:

Read all safety precautions and instructions carefully before operating equipment. Refer to operating instruction of equipment that this engine powers.

Ensure engine is stopped and level before performing any maintenance or service.

Warranty coverage as outlined in the warranty card and on KohlerEngines.com. Please review carefully as it provides your specific rights and obligations.

To maintain compliance with applicable emission regulations, exhaust system backpressure may not exceed limits which can be found on KohlerEngines.com. Search by Model No., then select Specs tab.

Kohler Engines has published CO₂ values on KohlerEngines.com website.

Record engine information to reference when ordering parts or obtaining warranty coverage.

Engine Model _____

Specification _____

Serial Number _____

Purchase Date _____

Safety Precautions

▲ WARNING: A hazard that could result in death, serious injury, or substantial property damage.

▲ CAUTION: A hazard that could result in minor personal injury or property damage.

NOTE: is used to notify people of important installation, operation, or maintenance information.

	<p>▲ WARNING</p> <p>Explosive Fuel can cause fires and severe burns.</p>
	<p>Do not fill fuel tank while engine is hot or running.</p>
<p>Gasoline is extremely flammable and its vapors can explode if ignited. Store gasoline only in approved containers, in well ventilated, unoccupied buildings, away from sparks or flames. Spilled fuel could ignite if it comes in contact with hot parts or sparks from ignition. Never use gasoline as a cleaning agent.</p>	

	<p>▲ WARNING</p> <p>Carbon Monoxide can cause severe nausea, fainting or death.</p>
	<p>Avoid inhaling exhaust fumes. Never run engine indoors or in enclosed spaces.</p>
<p>Engine exhaust gases contain poisonous carbon monoxide. Carbon monoxide is odorless, colorless, and can cause death if inhaled.</p>	

	<p>▲ WARNING</p> <p>Accidental Starts can cause severe injury or death.</p>
	<p>Disconnect and ground spark plug lead(s) before servicing.</p>
<p>Before working on engine or equipment, disable engine as follows: 1) Disconnect spark plug lead(s). 2) Disconnect negative (-) battery cable from battery.</p>	







	<p>▲ WARNING</p> <p>Rotating Parts can cause severe injury.</p>
	<p>Stay away while engine is in operation.</p>
<p>Keep hands, feet, hair, and clothing away from all moving parts to prevent injury. Never operate engine with covers, shrouds, or guards removed.</p>	

	<p>▲ CAUTION</p> <p>Electrical Shock can cause injury.</p>
	<p>Do not touch wires while engine is running.</p>

	<p>▲ WARNING</p> <p>Hot Parts can cause severe burns.</p>
	<p>Do not touch engine while operating or just after stopping.</p>
<p>Never operate engine with heat shields or guards removed.</p>	

<p>▲ WARNING: This product can expose you to chemicals including carbon monoxide and benzene, which are known to the State of California to cause cancer and birth defects or other reproductive harm. For more information go to www.P65Warnings.ca.gov.</p>
--

Symbols

					
Fuel	Off	On	Choke	Fast	Slow

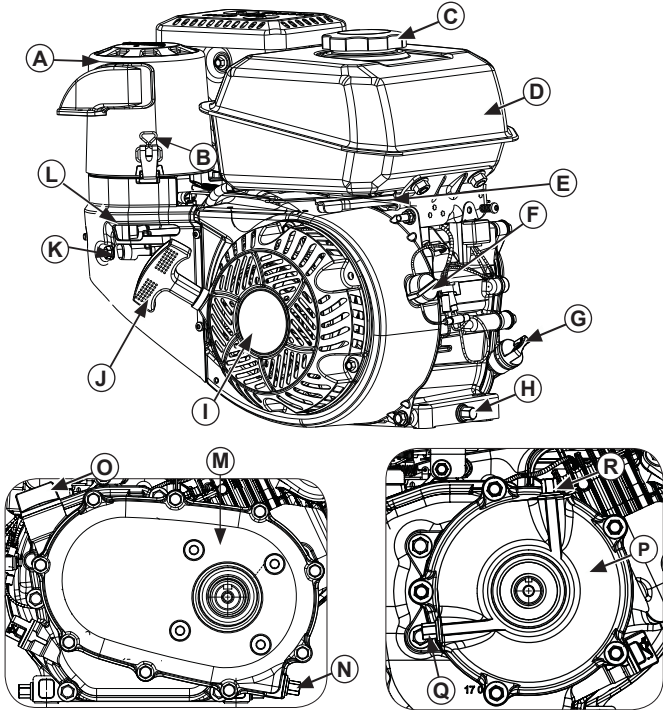

A	Air Cleaner Cover	B	Bail	C	Fuel Cap	D	Fuel Tank
E	Throttle Lever	F	On/Off Switch (if equipped)	G	Dipstick/Oil Fill Plug	H	Oil Drain Plug
I	Retractable Starter	J	Starter Handle	K	Fuel Shut-Off (and Ignition, if equipped)	L	Choke Lever
M	2:1 with Clutch Reduction System (CH245, CH270, CH395, CH440)	N	Drain Plug	O	Gear Box Dipstick	P	6:1 Reduction System (CH245, CH270)
Q	Oil Level/Drain Plug	R	Oil Fill Plug				

See next page for exploded view of air cleaner systems.

Visit KohlerEngines.com for service parts information and purchasing options.

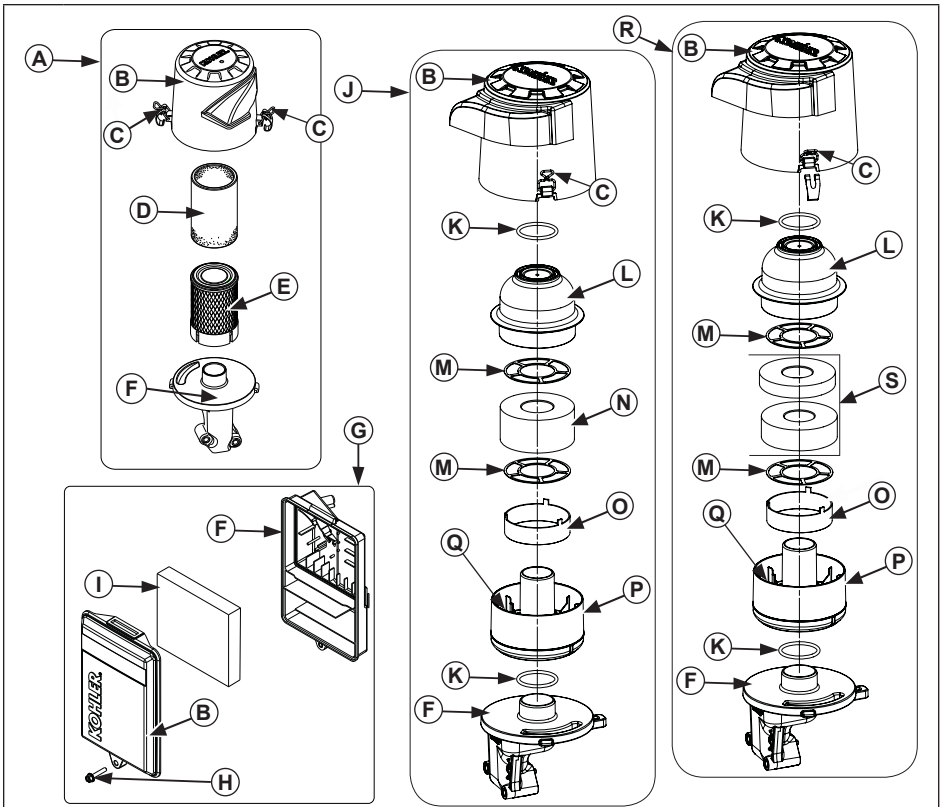





A	Quad-Clean™ Air Cleaner	B	Air Cleaner Cover	C	Bail	D	Precleaner
E	Paper Element	F	Air Cleaner Base	G	Low-Profile Air Cleaner	H	Screw
I	Foam Element	J	CH270 Oil Bath Air Cleaner	K	O-Ring	L	Foam Filter Cover
M	Foam Filter Support Plate	N	Foam Filter	O	Oil Retainer Ring	P	Oil Reservoir Cup
Q	Oil Level Mark	R	CH395/CH440 Oil Bath Air Cleaner	S	Foam Element Kit		

Pre-Start Checklist

1. Check oil level. Add oil if low. Do not overfill.
2. Check fuel level. Add fuel if low. Check fuel system components and lines for leaks.
3. Check and clean cooling areas, air intake areas and external surfaces of engine (particularly after storage).
4. Check that air cleaner components and all shrouds, equipment covers, and guards are in place and securely fastened.
5. Check spark arrestor (if equipped).
6. If equipped with oil bath air cleaner, check oil level in oil reservoir cup; add oil if below oil level mark; do not overfill; inspect for leaks. See Oil Bath Air Cleaner.

Starting

	 WARNING
	Carbon Monoxide can cause severe nausea, fainting or death. Avoid inhaling exhaust fumes. Never run engine indoors or in enclosed spaces.
Engine exhaust gases contain poisonous carbon monoxide. Carbon monoxide is odorless, colorless, and can cause death if inhaled.	

	 WARNING
	Rotating Parts can cause severe injury. Stay away while engine is in operation.
Keep hands, feet, hair, and clothing away from all moving parts to prevent injury. Never operate engine with covers, shrouds, or guards removed.	

NOTE: Choke position for starting may vary depending upon temperature and other factors. Once engine is running and warm, turn choke to OFF position.

NOTE: Extend starter cord periodically to check its condition. If cord is frayed have it replaced immediately by a Kohler authorized dealer.

NOTE: Do not crank engine continuously for more than 10 seconds. Allow a 60 second cool down period between starting attempts. Failure to follow these guidelines can burn out starter motor.

NOTE: If engine develops sufficient speed to disengage starter but does not keep running (a false start), engine rotation must be allowed to come to a complete stop before attempting to restart engine. If starter is engaged while flywheel is rotating, starter pinion and flywheel ring gear may clash, resulting in damage to starter.

1. Turn fuel shut-off valve to ON position (if equipped).
2. Turn engine on/off switch to ON position (if equipped).
3. Start engine as follows:

Cold engine: Place throttle control midway between SLOW and FAST positions. Place choke control into ON position.

Warm engine: Place throttle control midway between SLOW and FAST positions. Return choke to OFF position as soon as engine starts. A warm engine usually does not require choke on.

4. Retractable Start: Slowly pull starter handle until just past compression-STOP! Return starter handle; firmly pull straight out to avoid excessive rope wear from starter rope guide.

Electric Start: Activate starter switch. Release switch as soon as engine starts. If starter does not turn engine over, shut off starter immediately. Do not make further attempts to start engine until condition is corrected. Do not jump start. See your Kohler authorized dealer for trouble analysis.

5. Gradually return choke control to OFF position after engine starts and warms up. Engine/equipment may be operated during warm up period, but it may be necessary to leave choke partially on until engine warms up.

Cold Weather Starting Hints

1. Use proper oil for temperature expected.
2. Disengage all possible external loads.
3. Use fresh winter grade fuel. Winter grade fuel has higher volatility to improve starting.

Stopping

1. If possible, remove load by disengaging all PTO driven attachments.
2. If equipped, move throttle control to slow or idle position; stop engine.
3. If equipped, close fuel shut-off valve.

Angle of Operation

Refer to operating instructions of equipment this engine powers. Do not operate this engine exceeding maximum angle of operation; see specification table. Engine damage could result from insufficient lubrication.

Engine Speed

NOTE: Do not tamper with governor setting to increase maximum engine speed. Overspeed is hazardous and will void warranty.

High Altitude Operation

If this engine is operated at an altitude of 4000 ft. (1219 meters) or above, a high altitude carburetor kit is required. To obtain high altitude carburetor kit information or to find a Kohler authorized dealer, visit KohlerEngines.com or call 1-800-544-2444 (U.S. and Canada).

This engine should be operated in its original configuration below 4000 ft. (1219 meters).

Operating this engine with the wrong engine configuration at a given altitude may increase its emissions, decrease fuel efficiency and performance, and result in damage to the engine.

Carburetor Icing



NOTE: Running engine with cover positioned for cold weather operation in normal conditions can damage engine.

Carburetor icing can take place when certain combinations of temperature and humidity exist. Result of carburetor icing is rough running at idle or low speed as well as black or white smoke.

To reduce likelihood of carburetor icing, air cleaner cover can be rotated to draw warmer air from muffler side. For cold weather operation, position air cleaner cover with snowflake decal out.

For normal operation, position air cleaner cover with sun decal out.

Maintenance Instructions

	 WARNING	Before working on engine or equipment, disable engine as follows: 1) Disconnect spark plug lead(s). 2) Disconnect negative (-) battery cable from battery.
	Accidental Starts can cause severe injury or death. Disconnect and ground spark plug lead(s) before servicing.	

Normal maintenance, replacement or repair of emission control devices and systems may be performed by any repair establishment or individual; however, warranty repairs must be performed by a Kohler authorized dealer found at KohlerEngines.com or 1-800-544-2444 (U.S. and Canada).

Maintenance Schedule

After first 5 Hours

- Change engine oil (NOT required if using KOHLER PRO 10W-50 full-synthetic oil).

Every 8 Hours

- Check oil bath air cleaner oil level in oil reservoir cup (if equipped).

Every 50 Hours

- Change oil in 2:1 with Clutch Reduction System (CH245, CH255, CH270, CH395, CH440).

Every 50 Hours¹

- Service/replace oil bath air cleaner foam filter or foam elements (if equipped).

Every 50 Hours or Annually (whichever comes first)

- Service/replace Quad-Clean[™] precleaner.

Every 100 Hours or Annually¹ (whichever comes first)

- Clean low-profile air cleaner element.
- Change engine oil.
- Clean cooling areas.

Every 200 Hours

- Replace Quad-Clean[™] air cleaner element.

Every 300 Hours

- Replace low-profile air cleaner element.
- Check fuel filters (tank outlet filter and in-line filter) and clean or replace if needed (if equipped).
- Change oil in 6:1 Reduction System (CH245, CH255, CH270).

Every 300 Hours²

- Check and adjust valve clearance when engine is cold.

Every 300 Hours³

- Change engine oil (KOHLER PRO 10W-50 oil only).

Every 500 Hours or Annually¹ (whichever comes first)

- Replace spark plug and set gap.

¹ Perform these procedures more frequently under severe, dusty, dirty conditions.

² Have a Kohler authorized dealer perform this service.

³ Option only if using KOHLER[®] PRO oil.

Oil Recommendations

All-season KOHLER[®] PRO 10W-50 Synthetic Oil is the ideal oil for KOHLER engines. It is specifically formulated to extend the oil change interval to 300 Hours. Contact your Kohler authorized dealer for availability.

300-Hour oil change intervals are exclusive to and only authorized on KOHLER engines that utilize the KOHLER PRO 10W-50 Synthetic Oil. Alternative engine oils may be used with KOHLER engines but require 100-Hour oil change intervals for proper maintenance. Oil must be API (American Petroleum Institute) service class SJ or higher. Select viscosity based on air temperature at time of operation as shown below.

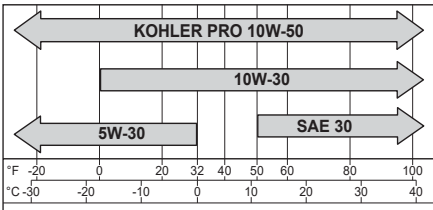

Check Oil Level

NOTE: To prevent extensive engine wear or damage, never run engine with oil level below or above operating range indicator on dipstick.

Ensure engine is cool and level. Clean oil fill/dipstick areas of any debris.

- Remove dipstick; wipe oil off.
- Reinsert dipstick into tube; rest on oil fill neck; turn counterclockwise until cap drops down to lowest point of thread leads; do not thread cap onto tube.
 - Remove dipstick; check oil level.

For CH260/CH270 engines, oil level should be at middle of indicator on dipstick.

For all other models, oil level should be at top of indicator on dipstick.

or
 - Remove oil fill plug.

For CH260/CH270 engines, oil level should be to middle of filler neck threads.

For all other models, oil level should be up to point of overflowing filler neck.
- If oil is low, add oil to specified level on dipstick or filler neck threads for engine being serviced. See step 2.
- Reinstall dipstick or oil fill plug and tighten securely.

Change Oil

Change oil while engine is warm.

- Clean area around oil fill cap/dipstick and drain plug.
- Remove drain plug and oil fill cap/dipstick. Drain oil completely.
- Reinstall drain plug. Torque to 13 ft. lb. (17.6 N·m).
- Fill crankcase with new oil to specified level on dipstick or filler neck threads for engine being serviced. See Check Oil Level.
- Reinstall oil fill cap/dipstick and tighten securely.
- Dispose of used oil in accordance with local ordinances.

Oil Sentry™ (if equipped)

This switch is designed to prevent engine from starting in a low oil or no oil condition. Oil Sentry™ may not shut down a running engine before damage occurs. In some applications this switch may activate a warning signal. Read your equipment manuals for more information.

Reduction Systems (if equipped)

Some engines are equipped with a gear reduction system. Follow maintenance and oil change information specified in this section and maintenance schedule.

2:1 Reduction System (CH270)

This reduction system is lubricated by engine crankcase oil. No special maintenance or service is necessary. Check and maintain engine oil level as outlined in Check Oil Level.

2:1 with Clutch Reduction System (CH245, CH255, CH270, CH395, CH440)

NOTE: Engines with this reduction system must be operated at 2400 RPM or higher under load, when full gear box engagement occurs. Operating engine under heavy loads below 2400 RPM, could result in clutch/gear box failure from disc slippage/overheating and insufficient engine cooling, not covered under normal warranty.

This reduction system uses a clutch assembly and chain and sprocket drive system, independent of, and separated from main crankcase lubrication. Check and maintain oil level using dipstick in gear box case. Change reduction system oil at interval in maintenance schedule. Use 20W-40 or 20W-50 oil in this gear box case. Oil capacity of this gear box is 0.5 L (0.52 U.S. qt.).

- Drain old oil out through oil drain plug of gear box cover, tip engine as required. Reinstall drain plug and tighten securely.

2. Engine must be level. Add new 20W-40 or 20W-50 oil through oil dipstick hole on top of gear box case until oil level is up to bottom of the mark on the oil dipstick in gear box case. Reinstall dipstick securely into gear box cover.

6:1 Reduction System (CH245, CH255, CH270)

This reduction system uses an internal pinion and ring gear system, independent of, and separated from main crankcase lubrication. Check and maintain oil level using oil level/drain plug hole in gear box case. Change reduction system oil at interval in maintenance schedule. Oil capacity of this gear box is 0.12 L (0.13 U.S. qt.).

1. Drain old oil out through oil level/drain plug, tip engine as required.
2. Engine must be level. Add new oil through oil fill plug hole on top until oil level is up to bottom of oil level/drain plug hole. Reinstall both plugs and tighten securely.

6:1 Reduction System (CH395, CH440)

This reduction system is lubricated by engine crankcase oil. No special maintenance or service is necessary. Check and maintain engine oil level as outlined in Check Oil Level.

Fuel Recommendations

	WARNING
	Explosive Fuel can cause fires and severe burns. Do not fill fuel tank while engine is hot or running.
Gasoline is extremely flammable and its vapors can explode if ignited. Store gasoline only in approved containers, in well ventilated, unoccupied buildings, away from sparks or flames. Spilled fuel could ignite if it comes in contact with hot parts or sparks from ignition. Never use gasoline as a cleaning agent.	

NOTE: E15, E20 and E85 are NOT approved and should NOT be used; effects of old, stale or contaminated fuel are not warrantable.

Fuel must meet these requirements:

- Clean, fresh, unleaded gasoline.
- Octane rating of 87 (R+M)/2 or higher.
- Research Octane Number (RON) 90 octane minimum.
- Gasoline up to 10% ethyl alcohol, 90% unleaded is acceptable.
- Methyl Tertiary Butyl Ether (MTBE) and unleaded gasoline blend (max 15% MTBE by volume) are approved.
- Do not add oil to gasoline.
- Do not overfill fuel tank.

- Do not use gasoline older than 30 days.

Add Fuel

	WARNING
	Explosive Fuel can cause fires and severe burns. Do not fill fuel tank while engine is hot or running.
Gasoline is extremely flammable and its vapors can explode if ignited. Store gasoline only in approved containers, in well ventilated, unoccupied buildings, away from sparks or flames. Spilled fuel could ignite if it comes in contact with hot parts or sparks from ignition. Never use gasoline as a cleaning agent.	

Nominal Fuel Tank Volume

CH245, CH255	2.75 qt. (2.6 L)
CH260, CH270	4.02 qt. (3.8 L)
CH395, CH440	7.19 qt. (6.8 L)

Ensure engine is cool.

1. Clean area around fuel cap.
2. Remove fuel cap. Fill to base of filler neck. Do not overfill fuel tank. Leave room for fuel to expand.
3. Reinstall fuel cap and tighten securely.

Fuel Line

Low permeation fuel line must be installed on carbureted Kohler Co. engines to maintain EPA and CARB regulatory compliance.

Fuel Valve

Engines are equipped with a fuel valve and integral screen filter located at inlet of carburetor. It controls and filters fuel flow from tank to carburetor. Clean fuel valve cup of debris.

1. Remove two nuts, two screws, and carburetor cover panel.
2. Turn fuel valve lever to OFF position.
3. Remove fuel valve cup. Remove O-ring and filter screen.
4. Clean screen and fuel valve cup with solvent and wipe it off.
5. Check screen and O-ring, replace if damaged.
6. Reinstall O-ring followed by fuel valve cup. Rotate fuel valve cup until it is finger tight. Turn with a wrench 1/2 to 3/4 full turn.
7. Turn fuel valve to ON position and check for leaks. If fuel valve leaks repeat steps 5 & 6.
8. Tighten fuel cap securely.

- Reinstall carburetor cover panel securing with hardware removed in step 1.

Spark Plugs

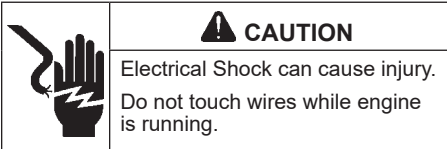

Clean out spark plug recess. Remove plug and replace.

- Check gap using wire feeler gauge. Adjust gap, see specification table for adjustment.
- Install plug into cylinder head.
- Torque plug to 20 ft. lb. (27 N·m).

Air Cleaner

NOTE: Running engine with cover positioned for cold weather operation in normal conditions can damage engine.

NOTE: Operating engine with loose or damaged air cleaner components could cause premature wear and failure. Replace all bent or damaged components.

NOTE: Paper element cannot be blown out with compressed air.

Quad-Clean™

Move bails on air cleaner cover down; remove latches from under tabs on base; remove cover.

or

Turn air cleaner cover (counterclockwise) to release tabs inside cover from base; remove cover.

Pre-cleaner:

- Remove pre-cleaner from paper element.
- Replace or wash pre-cleaner in warm water with detergent. Rinse and allow to air dry.
- Lightly oil pre-cleaner with new engine oil; squeeze out excess oil.
- Reinstall pre-cleaner over paper element.

Paper Element:

- Separate pre-cleaner from element; service pre-cleaner and replace paper element.
- Install new paper element on base; install pre-cleaner over paper element.

Position air cleaner cover for normal operation (sun decal out) or cold weather operation (snowflake decal out).

Place latches under tabs on base; lift up bails to secure cover.

or

Turn air cleaner cover (clockwise) to secure tabs inside cover in base.

Low-Profile

- Remove screw and air cleaner cover.
- Remove foam element from base.
- Wash foam element in warm water with detergent. Rinse and allow to air dry.
- Lightly oil foam element with new engine oil; squeeze out excess oil.
- Reinstall foam element into base.
- Reinstall cover and secure with screw.

Oil Bath

Some engines are equipped with an oil bath air cleaner. Follow maintenance and oil change information specified in this section and in Maintenance Schedule.

Move bails on air cleaner cover down; remove latches from under tabs on base; remove cover.

- Remove foam filter cover from oil reservoir cup. Remove foam filter support plate and foam filter or foam elements.
- CH270 engines: Replace or wash foam filter in warm water with detergent. Rinse and allow to air dry.
CH395/CH440 engines: Replace or wash foam elements in warm water with detergent. Rinse and allow to air dry.
- Lightly oil foam filter or foam elements with new engine oil; squeeze out excess oil.
- Remove foam filter support plate and oil retainer ring from oil reservoir cup.
- Remove oil reservoir cup from base. Empty oil from cup and wash cup in warm water with detergent. Rinse and dry cup.
- Make sure O-ring is in place on air cleaner base. Set oil reservoir cup on base.
- Fill oil reservoir cup up to oil level mark with same grade of oil as in crankcase. See Oil Recommendations.

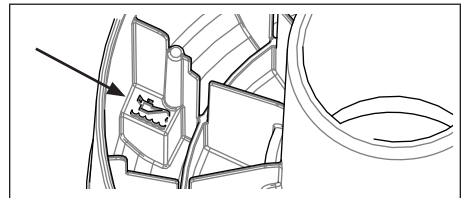

- Reinstall oil retainer ring and foam filter support plate in oil reservoir cup.

9. CH270 engines: Reinstall foam filter on oil reservoir cup. Place foam filter support plate on filter. Reinstall foam filter cover. Make sure O-ring is in place on top of filter cover.

CH395/CH440 engines: Reinstall taller foam element first, then shorter foam element on oil reservoir cup. Place foam filter support plate on elements. Reinstall foam filter cover. Make sure O-ring is in place on top of filter cover.

Position air cleaner cover for normal operation (sun decal out) or cold weather operation (snowflake decal out). Place latches under tabs on base; lift up bails to secure cover.

Breather Tube

Ensure both ends of breather tube are properly connected.

Air Cooling

	WARNING
	Hot Parts can cause severe burns. Do not touch engine while operating or just after stopping.
Never operate engine with heat shields or guards removed.	

Proper cooling is essential. To prevent over heating, clean screens, cooling fins, and other external surfaces of engine. Avoid spraying water at wiring harness or any electrical components. See Maintenance Schedule.

Repairs/Service Parts

We recommend that you use a Kohler authorized dealer for all maintenance, service, and replacement parts for engine. To find a Kohler authorized dealer visit KohlerEngines.com or call 1-800-544-2444 (U.S. and Canada).

Storage

If engine will be out of service for 2 months or more follow procedure below.

1. Add Kohler PRO Series fuel treatment or equivalent to fuel tank. Run engine 2-3 minutes to get stabilized fuel into fuel system (failures due to untreated fuel are not warrantable).
2. Change oil while engine is still warm from operation (NOT required if using KOHLER PRO 10W-50 full-synthetic oil). Remove spark plug(s) and pour about 1 oz. of engine oil into cylinder(s). Replace spark plug(s) and crank engine slowly to distribute oil.
3. If engine is equipped with oil bath air cleaner, clean and oil foam filter or foam elements and replace oil in oil reservoir cup. See Oil Bath Air Cleaner.
4. Disconnect negative (-) battery cable.
5. Store engine in a clean, dry place.

Troubleshooting

Do not attempt to service or replace major engine components, or any items that require special timing or adjustment procedures. This work should be performed by a Kohler authorized dealer.

Problem	Possible Cause							
	No Fuel	Improper Fuel	Dirt In Fuel Line	Dirty Debris Screen	Incorrect Oil Level	Engine Overloaded	Dirty Air Cleaner	Faulty Spark Plug
Will Not Start	•	•	•		•	•	•	•
Hard Starting		•	•		•	•	•	•
Stops Suddenly	•		•	•	•	•	•	•
Lacks Power		•	•	•	•	•	•	•
Operates Erratically		•	•	•		•	•	•
Knocks or Pings		•		•		•		•
Skips or Misfires		•	•	•			•	•
Backfires		•	•			•	•	•
Overheats		•	•	•	•	•	•	
High Fuel Consumption						•	•	•

Engine Specifications

Model	Bore	Stroke	Displacement	Oil Capacity (Refill)	Spark Plug Gap	Maximum Angle of Operation (@ full oil level)*
CH245	2.7 in. (68 mm)	1.9 in. (49 mm)	10.8 cu. in. (177 cc)	0.63 U.S. qt. (0.60 L)	0.030 in. (0.76 mm)	25°
CH255						
CH260	2.8 in. (70 mm)	2.1 in. (54 mm)	12.7 cu. in. (208 cc)			
CH270						
CH395, CH395DF, CH395TF	3.1 in. (78 mm)	2.3 in. (58 mm)	16.9 cu. in. (277 cc)	1.16 U.S. qt. (1.1 L)		
CH440, CH440DF	3.5 in. (89 mm)	2.7 in. (69 mm)	26.2 cu. in. (429 cc)			

*Exceeding maximum angle of operation may cause engine damage from insufficient lubrication.

Additional specification information can be found in service manual at KohlerEngines.com.

Any and all horsepower (hp) references by Kohler are Certified Power Ratings and per SAE J1940 & J1995 hp standards. Details on Certified Power Ratings can be found at KohlerEngines.com.

Emission Control System

Exhaust Emission Control System for models CH245, CH255, CH260, CH270, CH395, CH395DF, CH395TF, CH440, CH440DF is EM for U.S. EPA, California, and Europe. This engine is certified to operate on gasoline.

NOTE: Tampering with the engine and its emission control system voids the EPA Certificate of Conformity, ARB Executive Order, and EU type-approval.