



Russell Hobbs



COMPACT KITCHEN TOASTER OVEN

2 YEAR WARRANTY

RHTOV2HP

RHTOV2HP_IB&RB_FA_201216 Part No. T22-5003610

INSTRUCTIONS & WARRANTY



IMPORTANT SAFEGUARDS

When using this appliance, basic safety precautions should always be followed, including the following: Read all instructions before, and follow whilst using this appliance.

1. To protect against electrical hazards do not immerse the power cord, plug or toaster oven in water or any other liquid.
2. Do not use in the bathroom or near any source of water. 
3. Do not use outdoors.
4. The surfaces of the appliance will get hot.
5. The temperature of accessible surfaces/parts may become very hot when the appliance is operating and may remain hot for some time after the appliance has been switched off.
6. This appliance is not intended for use by persons (including children) with reduced physical, sensory or mental capabilities, or lack of experience and knowledge, unless they have been given supervision or instruction concerning use of the appliance by a person responsible for their safety.
7. Keep the oven and the power cord away from the edge of table or countertops and out of reach of children and persons with reduced physical, sensory or mental capabilities.
8. This appliance is not a toy. Children should be supervised to ensure they do not play with the appliance.
9. Do not leave this appliance unattended when in use.
10. Always switch off and unplug from the power outlet when not in use.
11. Always switch off and unplug from the power outlet and allow the oven to cool before cleaning.
12. To disconnect, set controls to OFF. Switch off the wall power outlet, then grasp the plug and remove from wall power socket. Never pull by the cord.
13. Do not operate this appliance with a damaged cord/plug or after the appliance has malfunctioned, or been dropped or damaged in any manner. Contact Customer Service for replacement, examination, repair or adjustment.
14. There are no user serviceable parts. If power cord or appliance is damaged, it must be replaced by the manufacturer or similarly qualified person in order to avoid a hazard.
15. Do not use on an inclined plane or unstable surface.
16. Do not move the oven while it is switched on.
17. Do not cover the oven when in use.
18. Oven gloves should be used when removing food items.
19. Always take care when removing hot food items from the oven.
20. Food may burn. Always monitor when using this appliance.
21. Do not use the oven near or below any curtains or other combustible materials.
22. Do not cook food items too large for the oven.
23. Do not cook food wrapped in plastic film or polythene bags. It will cause a fire hazard.
24. Do not place on or near any heat sources.
25. Do not clean with metal scouring pads. Pieces can break off the pad and touch electrical parts, creating a risk of electric shock.
26. Follow the instructions when cleaning this appliance.

27. Do not use appliance for anything other than its intended purpose.
28. Do not store any material, other than manufacturer's recommended accessories, in this oven when not in use.
29. Do not place any of the following materials in the oven: paper, cardboard, plastic, and the like.
30. Clean the oven and crumb tray regularly. Failure to do so may cause a fire hazard.
31. Do not cover crumb tray or any part of this oven with metal foil. This will cause overheating of the oven.
32. This appliance is not intended to be operated by means of an external timer or separate remote control system.
33. For added safety, electrical appliances should be connected to a power outlet that is protected by a residual current device (RCD), also often referred to as a 'Safety Switch'. Your switchboard may already incorporate an RCD. If unsure, call an electrician for verification and fitting if necessary.
34. This appliance is intended to be used in household and similar applications such as:
 - Staff kitchen areas in shops, offices and other working environments;
 - Farm houses;
 - By clients in hotels, motels, and other residential type environments;
 - Bed & breakfast type environments.

SAVE THESE INSTRUCTIONS.

Spectrum Brands Australia Pty Ltd

Locked Bag 3004 Braeside
Victoria 3195 Australia

Customer Service in Australia

TollFree: 1800 623 118
Email: info@spectrumbrands.com.au
Website: www.spectrumbrands.com.au

Spectrum Brands New Zealand Ltd

PO Box 9817 Newmarket
Auckland 1149 New Zealand

Customer Service in New Zealand

TollFree: 0800 736 776
Email: service@spectrumbrands.co.nz
Website: www.spectrumbrands.co.nz

Spectrum Brands Australia Pty Ltd and Spectrum Brands New Zealand Ltd Warranty Against Defects

In this warranty:

Australian Consumer Law means the Australian consumer law set out in Schedule 2 to the Competition and Consumer Act 2010;

CGA means the New Zealand Consumer Guarantees Act 1993;

Goods means the product or equipment which was accompanied by this warranty and purchased in Australia or New Zealand, as the case may be;

Manufacturer, We or **us** means:

1. for Goods purchased in Australia, Spectrum Brands Australia Pty Ltd ABN, 78 007 070 573;
or
2. for Goods purchased in New Zealand, Spectrum Brands New Zealand Ltd, as the case may be, contact details as set out at the end of this warranty;

Supplier means the authorised distributor or retailer of the Goods that sold you the Goods in Australia or in New Zealand; and

You means you, the original end-user purchaser of the Goods.

1. Our goods come with guarantees that cannot be excluded under the Australian Consumer Law, or the CGA. You are entitled to a replacement or refund for a major failure and compensation for any other reasonably foreseeable loss or damage. You are also entitled to have the goods repaired or replaced if the goods fail to be of acceptable quality and the failure does not amount to a major failure.
2. The benefits provided by this Warranty are in addition to all other rights and remedies in respect of the Goods which the consumer has under either the Australian Consumer Law or the CGA. The original purchaser of the Goods is provided with the following Warranty subject to the Warranty Conditions:
3. We warrant the Goods for all parts defective in workmanship or materials for the period of 2 years from the date of purchase. **(Warranty Period)**

If the Goods prove defective within the Warranty Period by reason of improper workmanship or material, we may, at our own discretion, repair or replace the Goods without charge.

Warranty Conditions

4. The Goods must be used in accordance with the manufacturer's instructions. This Warranty does not apply should the defect in or failure of the Goods be attributable to misuse, abuse, accident or non-observance of manufacturer's instructions on the part of the user. As far as the law permits, the manufacturer does not accept liability for any direct or consequential loss, damage or other expense caused by or arising out of any failure to use the Goods in accordance with the manufacturer's instructions.
 5. Exhaustible components (such as batteries, filters and brushes) of the Goods are included under this Warranty only where there is a defect in workmanship or materials used.
 6. The warranty granted under clause 3 is limited to repair or replacement only.
 7. Any parts of the Goods replaced during repairs or any product replaced remain the property of the manufacturer. In the event of the Goods being replaced during the Warranty Period, the warranty on the replacement Goods will expire on the same date as for the Warranty Period on the original Goods which are replaced.
 8. In order to claim under the warranty granted under clause 3 you must:
 - (a) Retain this warranty with your receipt/proof of purchase; and
 - (b) Return the Goods to us at the relevant address or to the Supplier by prepaid freight within the Warranty Period accompanied with (i) the legible and unmodified original proof of purchase, which clearly indicates the name and address of the Supplier, the date and place of purchase, the product name or other product serial number and (ii) this warranty.
 9. This warranty is immediately void if:
 - (a) Any serial number or appliance plate is removed or defaced;
 - (b) The Goods have been serviced or otherwise repaired by a person not authorised to do so by us or where non approved replaced parts are used.
 10. The Goods are designed for domestic use only. The Goods must be connected to the electrical voltage requirements as specified in the ratings label located on the Goods.
 11. This warranty does not cover the cost of claiming under the warranty or transport of the Goods to and from the Supplier or us.
 12. This warranty is only valid and enforceable in Australia against Spectrum Brands Australia Pty Ltd and in New Zealand against Spectrum Brands New Zealand Ltd.
- Contact us or the Supplier for further details.

Register your product online

If you live in Australia please visit: www.spectrumbrands.com.au/warranty

If you live in New Zealand Please visit: www.spectrumbrands.co.nz/warranty

Registration of your warranty is not compulsory, it gives us a record of your purchase AND entitles you to receive these benefits: Product information; Hints and tips; Recipes and news; Information on special price offers and promotions.

Any questions? Please contact Customer Service for advice.

Congratulations on the purchase of your new Russell Hobbs appliance. Each unit is manufactured to ensure safety and reliability.

Before using the appliance for the first time, please read this instruction booklet carefully and keep it for future reference. Pass it on if you pass on the appliance.

When using this appliance, basic safety precautions should always be followed.

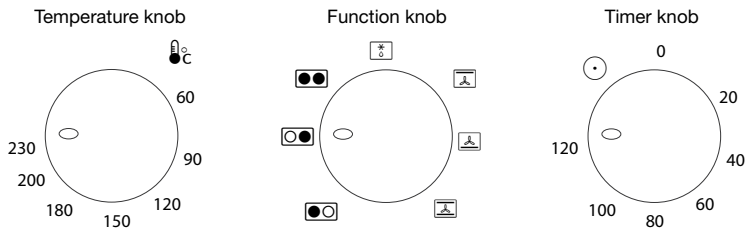
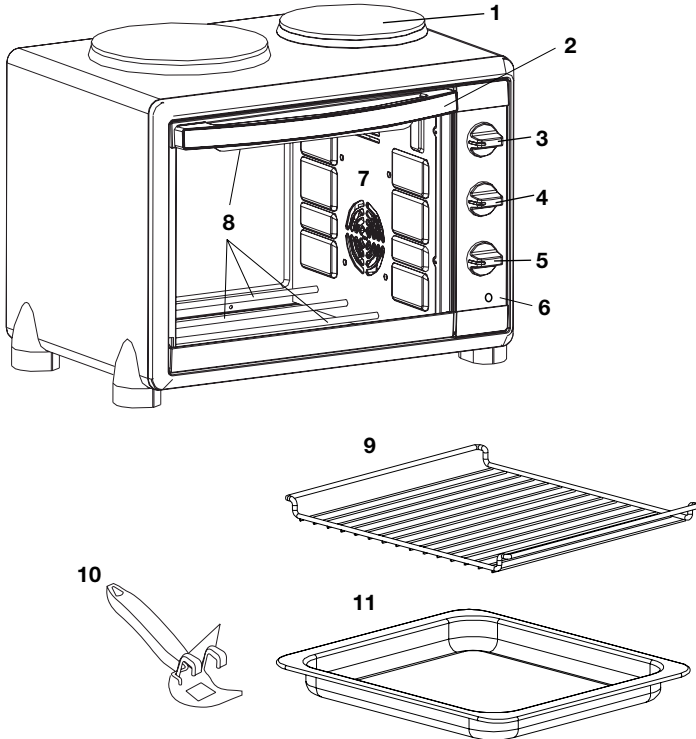



- | | |
|---------------------------|---------------------|
| 1. Hotplates | 7. Fan |
| 2. Door handle | 8. Heating elements |
| 3. Temperature knob | 9. Rack |
| 4. Function knob | 10. Tray handle |
| 5. Timer knob | 11. Tray |
| 6. Power indication light | |

PREPARATION

Sit the appliance on a stable, level, heat-resistant surface away from curtains and other flammable items.

BEFORE USING FOR THE FIRST TIME – CURE THE ELEMENTS

The following process will cure the new elements and burn off any dust, residues, etc., which may have accumulated on the elements. The new elements may give off an odour and a small amount of vapour whilst burning in; this is normal.

1. Check that there is no packaging left inside the oven, or wedged round the elements.
2. Open the kitchen windows, and make sure the room is adequately ventilated.
3. Close the toaster oven door.
4. Plug the toaster oven into a power outlet and switch the outlet on.
5. To turn the hotplates on: Turn the function knob to  and turn the timer to 20. After the timer returns to 0, and the bell sounds, leave the hotplates to cool down.
6. Then turn the function knob to . Turn the oven temperature knob  to 230 and turn the timer to 20, after the timer returns to 0, and the bell sounds, leave the oven to cool down.
7. When all elements have cooled down, the toaster oven is ready to use.

OPERATING YOUR OVEN

NOTE: The combination of oven and hotplates cannot be used at the same time.

TEMPERATURE KNOB



Turn the oven temperature knob to the cooking temperature you need.

FUNCTIONS:



COOKING	To use for oven cooking with both heating elements, turn the temperature knob to the cooking temperature you need.
GRILL	To grill, using only the top element, turn the temperature knob to 230, and leave the door open, to prevent the thermostat operating.
KEEP WARM	If you are using the bottom element to keep food warm after it has been thoroughly cooked, turn the temperature knob down to 100, and keep the door closed.
FAN	The fan will operate with any element combination

FUNCTION KNOB



OVEN FUNCTIONS:

-  Top element – for grilling.
-  Bottom element – for keeping food warm.
-  Both elements – for oven cooking.



HOTPLATE FUNCTIONS:

-  Operates the big hotplate.
-  Operates the small hotplate.
-  Operates both hotplates.

DEFROST FUNCTION

- Turn the function knob to , turn the timer anti clockwise to .
- This function enables you to defrost most foods without heat faster than some conventional methods as the oven fan circulates air around the food.
- It is particularly suitable for delicate frozen foods which are to be served cold e.g. cream filled gateaux, cakes covered with icings or frostings, cheesecakes, biscuits, scones etc.
- Defrosting time will vary greatly depending on the size and amount of food being defrosted.
- Ensure all meat and poultry has thoroughly defrosted before cooking.
- Always cook food straight after defrosting, do not re-freeze or store in the fridge.
- Care must always be taken when handling raw food.
- Always follow the basic rules of food hygiene to prevent bacterial growth and cross contamination when defrosting.

THE DOOR – OPEN OR CLOSED?

- Keep the door open when using the top element as a grill , to prevent the thermostat operating.
- Keep the door closed when using the bottom element  or both the top and bottom elements  together, to let the thermostat operate normally.
- The door gets hot. Even though you're using the handle, wear oven gloves.

MANUAL OPERATION OF YOUR OVEN

- Turn the timer anti-clockwise to  to turn the oven or hotplates on without using the timer.
- Turn the function knob to the desired function.
- After use turn timer knob to 0.

TIMER KNOB

- Turn the timer clockwise to set the time – you can set the time up to 120 minutes.
- When the timer ends, it sounds a bell, and turns the oven off.
- To turn the toaster oven off manually, turn the timer knob to 0.

INDICATION LIGHT

- The light will stay on when the toaster oven is in use.

COOKING TEMPERATURES

- Oven temperatures are comparable with those of a standard electric oven.
- As the oven is small, cooking times will generally be slightly shorter than with a large conventional oven.

- These temperatures are for guidance only.
- They are for fresh or fully defrosted food, using both elements, with the door closed.
- Check food is cooked through before serving. If in doubt, cook it a bit more.
- Cook meat, poultry, and any derivatives (mince, burgers, etc.) till the juices run clear.
- Cook fish till the flesh is opaque throughout.
- When cooking pre-packed foods, follow any guidelines on the package or label.

FOOD SETTING (°C)	
beef	190-210
bread	200-220
casseroles	140-160
chicken	190-210
fish	170-190
lamb	190-210
meringue	90-110
milk pudding	140-160

FOOD SETTING (°C)	
pastry	190-210
pork	190-210
quiche/flan	160-180
rich fruit cake	140-160
scones	190-220
sponge cake	160-180
Yorkshire pudding	200-220

Celsius	Fahrenheit	Gas Mark	Description
50	122	-	for plate warming
100	212	¼	extremely cool
130	250	½	very cool
140	275	1	very cool
150	300	2	cool
160-170	325	3	warm
180	350	4	moderate
190	375	5	fairly hot
200	400	6	fairly hot
210-220	425	7	hot
230	450	8	very hot

IMPORTANT INFORMATION ABOUT YOUR OVEN

PREHEATING

To preheat the oven, you'll find that setting the timer to 15 is usually sufficient.

THE RACK AND TRAY

NOTE: Use oven gloves to open and close the door, and when handling the rack and tray.

- The rack and tray slide on the shelf supports at the sides of the oven. Use the lower supports for baking and roasting.
- Use the upper supports for grilling, toasting, and browning toppings.
- If you are not cooking on the tray, put it on the bottom shelf support, to catch drips.

THE HANDLE

To fit the tray handle:

- a) Catch the hooks on the top of the tray.
- b) Lower the handle till the bottom catches the underside of the tray.
- c) Lift the handle, and the tray comes with it.

GRILLING AND SPITTING

- When grilling, or cooking anything that comes close to the top element, keep an eye on the food, to avoid fat or juices spitting on the top element.
- If you see spitting, move the food down, away from the top element.
- You may have to extend the cooking time slightly, to make up for the extra distance
- Spitting will make cleaning difficult.
- Residues burned on to the top element may shorten its life.
- Burned residues falling back into the food may affect the look of the food.
- In sufficient quantities, they might even affect its taste.

COOKING POTS AND PANS

- Use good quality, flat-bottomed pans that make good contact with the hotplate.
- The base of the pan should be the same size as the hotplate or slightly wider.
 - a) with too small a base, you will lose heat and overheat the pan sides and handle.
 - b) if it's too big, the pan may distort, the hotplate may overheat.
 - c) if it covers both hotplates (like a catering pan), it'll overheat the toaster oven.
 - d) these may all cause damage to the toaster oven.

DISCOLOURATION

Over time, heat will cause discolouration of the surfaces. This is unavoidable, but it will not affect the functionality of the toaster oven.

CARE AND MAINTENANCE

Important: Before cleaning any part, be sure the oven is off, unplugged, and cool.

- Wipe up all spillages on surface, to avoid discolouring the surfaces and corroding the hotplates.
- Clean the glass door with a sponge, soft cloth, or nylon pad and warm, soapy water. Do not use a spray cleaner.
- To remove the rack and tray, open the door, pull them forward and out.
- Wash the rack by hand in soapy water. To remove stubborn spots, use a polyester or nylon pad.



Russell Hobbs



RECIPE BOOK

COMPACT KITCHEN TOASTER OVEN

RHTOV2HP

INSTRUCTIONS & WARRANTY

SMOKED SALMON BAGELS

Serves 2

Preparation time: 10 minutes

Cooking time: 10 minutes

INGREDIENTS

2 fresh store-bought bagels

100g spreadable cream cheese

2 teaspoons finely chopped red onion

1 teaspoon baby capers, rinsed & roughly chopped

1 teaspoon lemon juice

½ teaspoon chopped dill (optional)

Cracked black pepper, to taste

100g smoked salmon slices

Soft green lettuce leaves, to serve

1. Insert a wire rack on the top oven shelf. Select the GRILL FUNCTION (top element only), set the TEMPERATURE to 230°C, and the TIMER for 20 minutes.
2. Slice the bagels in half diagonally, and place cut side up on the wire rack. Grill with the oven door open until lightly golden; about 5 minutes. Flip the bagels and toast for a further 3-4 minutes.
3. Meanwhile, in a bowl combine the cream cheese, onion, capers, lemon juice and dill (if using). Season well with cracked black pepper.
4. Spread the freshly toasted bagels with the cream cheese mixture, top with smoked salmon slices and lettuce leaves. Serve.

www.russellhobbs.com.au

www.russellhobbs.co.nz

RUSSELL HOBBS® and logo are Trade Marks of Spectrum Brands, Inc., or one of its subsidiaries.
©2016 Spectrum Brands, Inc.

Recipes are to be used in conjunction with the RHTOV2H Compact Kitchen Toaster Oven by Russell Hobbs. All rights reserved. No part of this publication may be reproduced, stored in a retrieval system or transmitted in any form or by any means, electronic, mechanical, photocopying, recording or otherwise, without prior permission of the copyright owner.

CROQUE MONSIEUR SANDWICH

Serves 2

Preparation time: 10 minutes

Cooking time: 9 minutes

INGREDIENTS

4 slices good-quality
sourdough bread

20g salted butter, softened

2 Tablespoons Dijon mustard

150g good-quality thick cut
ham

60g Gruyère or vintage
cheddar cheese, finely sliced

½ cup pre-made béchamel
sauce, chilled

2 Tablespoons finely grated
parmesan cheese

Cracked black pepper, to serve

1. Select the GRILL FUNCTION (top element only), set the TEMPERATURE to 230°C, and TIMER for 40 minutes.
2. Butter the bread slices and place on a foil-lined oven tray. Insert the tray on the top oven shelf. Grill with the oven door open until lightly golden and toasted; 5 minutes.
3. Flip the bread slices and spread the other side with mustard. Set 2 slices aside. Top the other 2 slices with the ham and cheese. Insert the tray on the second oven shelf and grill with the oven door open, until the cheese melts; 5 minutes.
4. Place the other bread slices on top, mustard side down. Carefully spread béchamel over each sandwich and top with grated parmesan. Return the tray to the second oven shelf. Grill with the oven door open, until the tops are bubbling and golden; about 5 minutes. Serve warm, with a good grinding of black pepper.

BÉCHAMEL SAUCE

Makes 1 cup

Preparation time: 5 minutes

Cooking time: 5 minutes

INGREDIENTS

30g salted butter

30g plain flour

300ml full-fat milk

Salt and cracked black pepper,
to taste

1. Select the LARGE HOTPLATE FUNCTION and set the TIMER for 20 minutes. Melt the butter in a medium saucepan over the hob. Add the flour and stir for 1 minute.
2. Add the milk and whisk continuously using a balloon whisk, until the sauce thickens enough to coat the back of a spoon. Season with salt and pepper. Cool.

GREEK SPINACH FILO PIE

Serves 6

Preparation time: 15 minutes

Cooking time: 25 minutes

INGREDIENTS

500g frozen spinach, defrosted

½ bunch spring onions, white & green ends chopped

200g crumbled feta cheese

60g finely grated parmesan cheese

2 eggs, lightly beaten

¼ cup finely chopped fresh mint leaves

1 Tablespoon finely chopped fresh dill

Freshly grated nutmeg, to taste

50g butter, melted

¼ cup extra virgin olive oil

12 sheets good-quality Greek filo pastry

1. Insert a wire rack on third oven shelf. Select the OVEN FUNCTION (top & bottom elements), set the TEMPERATURE to 190°C, and TIMER for 10 minutes; a beep will sound once the oven is preheated.
2. Place the spinach in a fine sieve and press to remove any excess liquid. Transfer the strained spinach to a large bowl with the spring onion, cheeses, eggs, chopped herbs and nutmeg. Mix thoroughly, and set aside.
3. Combine the butter and oil, and grease the inside of a 30cm diameter pie tin. Lay one sheet of filo inside the tin and brush with butter mixture. Lay another sheet diagonally across the first and brush again. Repeat, using 9 sheets of filo (reserving 3 sheets for the top of the pie).
4. Spoon the filling mixture into the tin. Top with remaining filo sheets (brushing and layering, as with the previous sheets). Fold in the overhanging filo to enclose the filling. Brush the top with remaining butter.
5. Once preheated, reset the TIMER for 30 minutes. Place the pie on the wire rack and bake until the pastry is crisp and golden brown. Serve with a green salad.

CHOCOLATE BROWNIES

Makes 12

Preparation time: 15 minutes

Cooking time: 35 minutes

INGREDIENTS

250g unsalted butter

300g light brown sugar

3 medium eggs

250g dark chocolate, melted

75g self-raising flour

75g cocoa powder, extra for dusting

¼ tsp salt flakes

75g pecans or walnuts, roughly chopped

1. Grease and line a 16 x 26 cm rectangle baking tin.
2. Select the **SMALL HOTPLATE FUNCTION** and set the **TIMER** for 10 minutes. Melt the chocolate in a small saucepan on the hotplate, stirring constantly with a spatula until just melted. Set aside to cool.
3. Insert a wire rack on the third oven shelf. Select the **OVEN FUNCION** (top & bottom elements), set the **TEMPERATURE** to 180°C, and **TIMER** for 10 minutes; a beep will sound once the oven is preheated.
4. Meanwhile cream the butter and sugar in the bowl of an electric mixer until pale and creamy; about 5 minutes. Add the eggs, one at a time, beating well between each addition. Fold in the melted chocolate.
5. Sift the flour and cocoa. Fold into the chocolate mixture with the salt and nuts. Pour the batter into the prepared cake tin.
6. Once preheated, place the cake tin on the wire rack and set the **TIMER** for 30 minutes; the brownie should crack slightly at the edges, but still be soft in the center. (It will set once cooled). Cool the brownie in the tin completely before slicing.

TIP: brownie will store well in the refrigerator for 3-4 days.

CINNAMON BUNS

Makes 6

Preparation time: 75 minutes

Cooking time: 25 minutes

INGREDIENTS

Cinnamon filling

80g pecans, chopped

80g dark brown sugar

1 Tablespoon ground
cinnamon

1 teaspoon corn flour

500g strong white bread flour

7g sachet dried yeast

½ teaspoon salt

115g unsalted butter, softened
(+ extra to grease tin)

275ml luke warm milk

1 egg, lightly beaten

25g demerara sugar

1. Grease an 18 x 28cm baking tin with butter. Combine the cinnamon filling ingredients and set aside.
2. Select the SMALL HOTPLATE FUNCTION and set the TIMER for 10 minutes. Melt the butter in a saucepan over the hob, add the milk, and heat until luke warm. Remove from the heat and beat in the egg.
3. In a large bowl combine the flour, yeast and salt. Make a well in the center, add the milk mixture and stir until the dough just comes together. Turn out onto a lightly floured surface and knead for 5 minutes, or until the dough is smooth and elastic.
4. Roll the dough into a 30 x 40cm rectangle. Spread with the remaining softened butter, and sprinkle with the cinnamon filling.
5. Starting from the long side, roll the dough tightly into a Swiss roll shape. Trim the ends, then cut into 6 x 6cm thick slices. Place the slices cut side down into the prepared baking tin, pressing gently. Leave in a warm place for 1 hour to rise.
6. Insert a wire rack on the third oven shelf. Select the OVEN FUNCION (top & bottom elements), set the TEMPERATURE to 180°C, and TIMER for 10 minutes; a beep will sound once the oven has preheated.
7. Reset the TIMER for 20 minutes, sprinkle the risen buns with demerara sugar. Place the tin on the wire rack and bake until buns are golden brown. Serve warm.

MEDITERRANEAN VEGETABLE GRATIN

Serves 6

Preparation time: 15 minutes

Cooking time: 70 minutes

INGREDIENTS

2 medium zucchini, cut into
3mm thick slices

1 medium eggplant, cut into
3mm thick slices

1 medium red capsicum, seeds
removed & thinly sliced

1 clove garlic, crushed

2 Tablespoons extra virgin
olive oil

1 teaspoon freshly picked
thyme leaves (optional)

salt flakes & cracked black
pepper, to taste

500ml good-quality tomato
sugo

200g fresh mozzarella cheese,
sliced

50g fresh breadcrumbs

15g finely grated parmesan
cheese

handful fresh basil leaves, to
serve

1. Toss the zucchini, eggplant and capsicum in a bowl with the garlic, half the oil and thyme (if using). Season with salt and pepper.
2. Layer the vegetables in a 20 x 30cm baking dish with the tomato sugo. Top with mozzarella slices. Cover the dish tightly with foil.
3. Insert a wire rack on the third oven shelf. Select the OVEN FUNCTION (top & bottom elements) set the TEMPERATURE to 200°C, and TIMER for 60 minutes. Place the dish on the wire rack and bake until the vegetables are tender.
4. Meanwhile combine the breadcrumbs, parmesan and remaining thyme. Set aside.
5. When the timer sounds, remove the foil from the dish and sprinkle the breadcrumbs on top. Select the GRILL FUNCTION (top element only), set the TEMPERATURE to 230°C, and TIMER for 10 minutes. Grill with the oven door open, until the breadcrumbs are golden brown. Scatter with basil leaves to serve.

ZA'ATAR SPICED PITA CHIPS

Serves 4 (as a snack)

Preparation time: 5 minutes

Cooking time: 15 minutes

INGREDIENTS

2 wholemeal pita breads

Olive oil spray

2 teaspoons za'atar spice mix

1 teaspoon smoked paprika

Salt flakes and cracked black pepper, to taste

1. Separate each pita into two (the top from the bottom). Stack the rounds, cut them in half and then into wedges; this should make around 24 pita pieces.
2. Select the OVEN FUNCTION (top & bottom elements), set the TEMPERATURE to 200°C, and TIMER for 30 minutes. Spread half the pita triangles over the wire rack. Spray with olive oil, then sprinkle with half the za'atar and paprika, salt and pepper.
3. Insert a wire rack on the second oven shelf and bake 5 minutes, or until the pita pieces are golden brown and crisp. Using the oven handle or an oven mitt, safely transfer the pita chips to a plate. Repeat with remaining pita bread and seasoning.

Serve with your favourite dip, or as a crunchy addition to a salad.

TIP: Pita chips will keep in an airtight container for up to one week.

SOURDOUGH CROUTONS

Serves 4

Preparation time: 10 minutes

Cooking time: 15 minutes

INGREDIENTS

200g day-old sourdough bread slices

2 cloves garlic

2 Tablespoons olive oil

Salt flakes

1. Select the OVEN FUNCTION (top & bottom elements), set the TEMPERATURE to 200°C, and the TIMER for 20 minutes.
2. Cut the garlic cloves in half and rub the cut side over the bread. Remove the crusts from the bread, cut or tear into 2cm pieces, then toss in a bowl with the olive oil. Spread in a single layer over the baking tray, and sprinkle with salt flakes.
3. Insert the tray on the second oven shelf and bake for 5 minutes, or until the croutons are lightly crisp and golden.

RUSTIC ITALIAN TOMATO SALAD

Serves 4

Preparation time: 5 minutes

INGREDIENTS

¼ cup extra virgin olive oil

1½ Tablespoons red wine vinegar

Salt and cracked black pepper

1kg vine-ripened tomatoes, roughly chopped

½ red onion, finely sliced

1 Tablespoon salted capers, rinsed well & roughly chopped

Large handful basil and parsley leaves, roughly chopped

200g sourdough croutons (recipe above)

1. Combine the oil and vinegar in a large bowl, seasoning with salt and pepper to taste. Add the remaining ingredients, and toss well. Serve.