



DRAPER
Expert

30, 40, 50 TONNE PNEUMATIC JACKS

02078 / 02079 / 02080 / 02081



IMPORTANT: Please read these instructions carefully to ensure the safe and effective use of this product and save these instructions for future reference. This manual has been compiled by Draper Tools and is an integrated part of the product with which it is enclosed and should be kept with it for future references.

This manual describes the purpose for which the product has been designed and contains all the necessary information to ensure its correct and safe use. We recommend that this manual is read before any operation or, before performing any kind of adjustment to the product and prior to any maintenance tasks. By following all the general safety instructions contained in this manual, it will ensure both product and operator safety, together with longer life of the product itself.

All photographs and drawings in this manual are supplied by Draper Tools to help illustrate the operation of the product.

Whilst every effort has been made to ensure accuracy of information contained in this manual, the Draper Tools policy of continuous improvement determines the right to make modifications without prior warning.

1. TITLE PAGE

1.1 INTRODUCTION:

USER MANUAL FOR: 30, 40 & 50 TONNE PNEUMATIC JACKS
Stock No's. 02078 / 02079 / 02080 / 02081
Part No's. PJ30HL / PJ40SC / PJ40LC / PJ50

1.2 REVISIONS:

Date first published July 2018.

As our user manuals are continually updated, users should make sure that they use the very latest version.

Downloads are available from: <http://drapertools.com/manuals>

Draper Tools Limited
Hursley Road
Chandler's Ford
Eastleigh
Hampshire
SO53 1YF
UK

Website: drapertools.com

Product Helpline: +44 (0) 23 8049 4344

General Fax: +44 (0) 23 8026 0784

1.3 UNDERSTANDING THIS MANUALS SAFETY CONTENT:

WARNING! – Information that draws attention to the risk of injury or death.

CAUTION! – Information that draws attention to the risk of damage to the product or surroundings.

1.4 COPYRIGHT © NOTICE:

Copyright © Draper Tools Limited.

Permission is granted to reproduce this publication for personal and educational use only. Commercial copying, redistribution, hiring or lending is prohibited.

No part of this publication may be stored in a retrieval system or transmitted in any other form or means without written permission from Draper Tools Limited.

In all cases this copyright notice must remain intact.

2. CONTENTS

2.1 CONTENTS

Page content	Page
1 TITLE PAGE	
1.1 INTRODUCTION	2
1.2 REVISION HISTORY	2
1.3 UNDERSTANDING THIS MANUAL	2
1.4 COPYRIGHT NOTICE	2
2 CONTENTS	
2.1 CONTENTS	3
3 GUARANTEE	
3.1 GUARANTEE	4
4 INTRODUCTION	
4.1 SCOPE	5
4.2 SPECIFICATION	5
4.3 HANDLING & STORAGE	5
5 HEALTH & SAFETY INFORMATION	
5.1 SAFETY PRECAUTIONS	7
6 OPERATING INSTRUCTIONS	
6.1 HANDLE ASSEMBLY	8
6.2 CONNECT AN AIR SUPPLY TO THE JACK CONNECTOR	8
6.3 OPERATION	9
7 MAINTENANCE	
7.1 MAINTENANCE	10
8 DISPOSAL	
8.1 DISPOSAL	11
DECLARATION OF CONFORMITY	ENCLOSED

3. GUARANTEE

3.1 GUARANTEE

Draper tools have been carefully tested and inspected before shipment and are guaranteed to be free from defective materials and workmanship.

Should the tool develop a fault, please return the complete tool to your nearest distributor or contact:

Draper Tools Limited, Chandler's Ford, Eastleigh, Hampshire, SO53 1YF. England.

Telephone Sales Desk: (023) 8049 4333 or:

Product Helpline (023) 8049 4344.

A proof of purchase must be provided.

If upon inspection it is found that the fault occurring is due to defective materials or workmanship, repairs will be carried out free of charge. This guarantee period covering parts/labour is 12 months from the date of purchase except where tools are hired out when the guarantee period is 90 days from the date of purchase. This guarantee does not apply to any consumable parts, any type of battery or normal wear and tear, nor does it cover any damage caused by misuse, careless or unsafe handling, alterations, accidents, or repairs attempted or made by any personnel other than the authorised Draper warranty repair agent.

Note: If the tool is found not to be within the terms of warranty, repairs and carriage charges will be quoted and made accordingly.

This guarantee applies in lieu of any other guarantee expressed or implied and variations of its terms are not authorised.

Your Draper guarantee is not effective unless you can produce upon request a dated receipt or invoice to verify your proof of purchase within the guarantee period.

Please note that this guarantee is an additional benefit and does not affect your statutory rights.

Draper Tools Limited.

4. INTRODUCTION

4.1 SCOPE

This jack is designed to lift vehicles to the maximum stated weight limit and height, it is for lifting only and axle stands must be used to support load..

4.2 SPECIFICATION

Stock No:	02078	02079	02080	02081
Part No:	PJ30HL	PJ40SC	PJ40LC	PJ50
Max. Capacity:.....	30 Tonne	40 Tonne.....	40 Tonne	50 Tonne
Min. Height (approx.):.....	360mm	150mm	125mm	215mm
Maximum height (inc. extensions)/capacity:				
Stage 1 (mm/tonne).....	772/30	343/40	302/40.....	450/50
Stage 2 (mm/tonne).....	—	409/20	347/20.....	564/25
Stage 3 (mm/tonne).....	—	—	396/10.....	—
Extensions (approx.)	45/100mm	45/75mm	45/75mm.....	45/75mm
Chassis length (approx.)	840mm	480mm	830mm	805mm
Handle length (approx.).....	1380mm	1300mm.....	1380mm	1380mm
Chassis width (approx.).....	215mm	186mm	179mm	200mm
Air consumption (approx.) ..	11.5cfm	11.5cfm.....	11.5cfm	11.5cfm
Operating air pressure:.....	130-174psi.....	130-174psi.....	130-174psi	130-174psi
Nett weight (approx.)	90kg.....	49kg	50kg	84kg

EXTREMELY IMPORTANT: Read these safety instructions carefully in addition to the instructions for use, operation and maintenance. Keep these instructions sheet in an easy to find place as you may need to use it again.

This jack has been designed for use in the elevation of vehicles.

Any other application, beyond the conditions established for use of this jack will be considered inappropriate.

Handle the jack correctly and ensure that all parts are in good condition prior to its use.

Only authorised persons should operate the jack having read carefully and understood the contents of this manual.

Do not modify the jack in any way.

Non-compliance with these rules may result in injury or damage to the user, the jack or the vehicle to be lifted.

The manufacturer accepts no responsibility for the improper use of the jack.

4.3 HANDLING AND STORAGE

Care must still be taken when handling and lifting. Dropping this jack will have an effect on the jack and may also result in personal injury. This jack is not a toy and must be respected.

The environment will have a negative result on its operation if you are not careful. If the air is damp, components will rust. If the jack is unprotected from dust and debris; components will become clogged: and if not cleaned and maintained correctly or regularly the jack will not perform at its best.

5. HEALTH & SAFETY INFORMATION

1 - BEFORE POSITIONING THE JACK, YOU SHOULD ENSURE THE FOLLOWING:

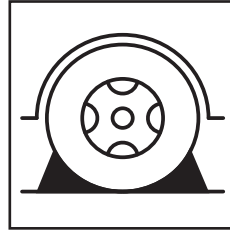
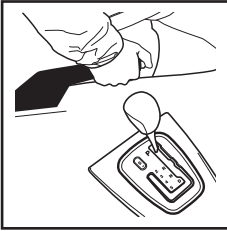

- i. Vehicle should be clear of all passengers. Transmission should be in gear (or 'Park' for automatic transmissions) and the handbrake applied.
- ii. To prevent vehicle from movement, wheels should be securely blocked with wheel chocks (Draper Stock No.54500).

2 - CORRECT POSITIONING:

The jack should be positioned under the approved lifting points for the vehicle. Since these points may vary with each vehicle, it is important to refer to the vehicle manufacturer's or Haynes workshop manuals.

3 - TERRAIN:

The jack should be operated on a hard and level surface as the location will permit, concrete is preferred.

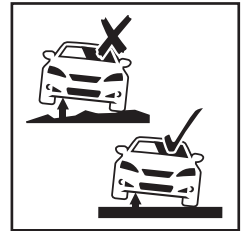

4 - NEVER EXCEED THE JACK'S RATED CAPACITY.

NEVER work under a vehicle without axle stands correctly supporting the vehicle weight.

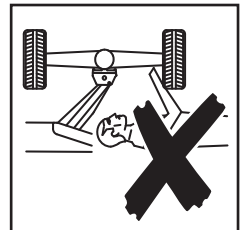

5. HEALTH & SAFETY INFORMATION

5 - WORKING UNDER THE VEHICLE:

It is extremely important, when working under the vehicle, to ensure axle stands are always used.

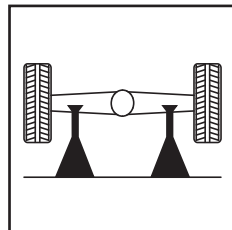

5.1 SAFETY PRECAUTIONS

1. The vehicle to be lifted should never exceed the rated capacity of the jack.
2. The maximum stroke of the jack indicated on the label should never be exceeded.
3. The jack should be supported on a solid, level and horizontal surface which is well illuminated and free of obstructions. Never stand the jack on a surface which may sink.
4. Ensure that there are no persons inside the vehicle to be lifted. Switch off the engine and apply the brake. Ensure the vehicle or element to be lifted against any type of sliding. Use chocks if appropriate (1). Do not enter the vehicle or start the engine whilst it is supported on the jack or appropriate stands. The jack is a lifting device only and should never be used to move the vehicle.
5. Position the jack under the manufacturer's recommended lifting point for the vehicle and ensure that it is not corroded, dirty or greasy. This point should remain centred over the jack saddle. All off-centred loads can slip and accidents may result.
6. During raising and lowering of the load, all precautions should be taken to avoid movement of the vehicle load. Traffic may cause the raised vehicle to rock during roadside use of the jack.
7. The jack should be positioned so as to avoid the need for the user to introduce any part of his/her body underneath the vehicle. Never work under a raised vehicle without supporting it with axle stands (5) or other appropriate methods. Never position any part of your body near the movable elements of the jack.
8. It is necessary for the operator to be able to observe the lifting device and the load during all movements. In the presence of dangerous conditions, such as movement of the vehicle, etc, the lifting process must be interrupted.
9. Ensure that there are no persons or obstructions underneath the vehicle prior to lowering.
10. As an additional safety measure against overload, the jack is fitted with an overload valve set at the factory and which should not be adjusted under any circumstances. If the capacity of the jack is exceeded, the overload valve will stop the lifting operation.

CAUTION:

- Use only on a firm, level surface, concrete is preferred.
- Do not exceed the rated capacity of this jack.
- This is a lifting device only ... do not work under the vehicle without proper support devices, such as axle stands.
- Make sure that the lifting point is stable and correctly centred on the jack saddle.
- Familiarize yourself thoroughly with this manual before operating to prevent damage to the jack, property, or personal injury.

6. OPERATING INSTRUCTIONS

6.1 HANDLE ASSEMBLY FIG 1 & 2.

1. Remove the circlip ① from the handle securing pin and slide the pin out.
2. Insert the handle into the jack body ensuring the handle is in the upright position.
3. Re-fit the handle securing pin through the jack frame & handle. Ensure circlip is re-attached to the end of the pin.
4. Loop the black air hose around the handle securing pin then fully push the hose into the connector (fig.2).
5. Follow above procedure for transparent hose (as label diagram ②).

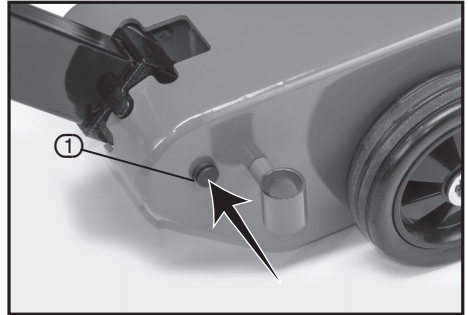

FIG.1

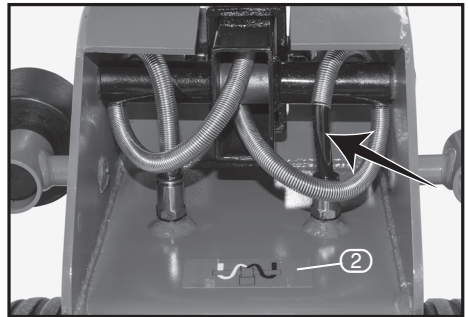

FIG.2

6.2 BLEEDING AIR FROM THE SYSTEM

Prior to operating the jack, the hydraulic circuit must be purged to expel any accumulated air from the system.

1. Push the lever to the down position. Hold the lever in this position for a few seconds.
2. Without any load, continue to operate the jack. Ensuring the jack reaches the highest point and returned to the lowest.
3. Repeat last step until the movement of the piston is smooth & consistent before using with any load applied.

6. OPERATING INSTRUCTIONS

6.3 OPERATION

1. **IMPORTANT:** Prior to lifting the load, ensure that all of the afore mentioned safety instructions are followed.
2. The wheels of the jacks should always rotate freely.
3. For lifting, use the handle to position jack saddle pad into position below approved vehicle lifting point (check correct position with vehicle manufacturer before lifting) once jack contacts lift point, move the control lever to the 'up' position. Secure the lifted load as an essential safety measure with appropriate axle stands.
4. Before lowering, lift the vehicle to remove the axle stands, ensuring that there are no persons or obstacles under the vehicle to be lowered. Carefully move the control lever to the 'down' position to gently lower the load.
5. Once finished, the air supply can be disconnected and the jack can be stored accordingly.

7. MAINTENANCE

7.1 MAINTENANCE

1. **IMPORTANT:** Both the maintenance and repair of the jack may only be performed by qualified persons, who have sufficient knowledge of the hydraulic systems used in these devices as a result of their training and experience.
2. Keep the jack clean and lubricate all moving parts at regular intervals, which must be clean and protected from aggressive conditions at all times.
3. Only original spare parts should be used.
4. Prior to each use, check for bent, broken, cracked or loose parts. Do not use if any defects are present. If it is suspected that the jack has been subjected to abnormal loads or has suffered any knocks, withdraw it from service until the problem has been rectified.
5. If the oil level needs to be checked or refilled, with the piston fully retracted, remove the filler plug and drain its contents into a container. With the jack in a horizontal position, proceed to introduce the necessary volume of oil required.
6. Make sure that no dirt enters with the new oil. Ensure the air filter is free from dirt.
7. Following a period of prolonged intensive use, it is recommendable to change the oil in order to extend the useful life of the jack.
8. **IMPORTANT:** An excess of oil to the volume required may render the jack inoperative.
9. Only use suitable hydraulic oil. Never use brake fluid.
10. When the jack is not in use, make sure the lifting arm is fully retracted to avoid corrosion. Apply an anti-corrosion product to the pistons, if appropriate.
11. Keep the jack in a clean, dry place and out of children's reach. Remove the operating handle.
12. At the end of the useful life of the jack, drain off the oil and hand it over to an authorised agent and dispose of the jack in accordance with local regulations.

8. DISPOSAL

8.1 DISPOSAL

At the end of the machine's working life, or when it can no longer be repaired, ensure that it is disposed of according to national regulations.

Contact your local authority for details of collection schemes in your area.

In all circumstances:

- Do not dispose of tools with domestic waste.
- Do not incinerate.
- Do not abandon in the environment.
- Remove oil from the jack so it can be recycled.

CONTACT US

Draper Tools Limited, Hursley Road,
Chandler's Ford, Eastleigh, Hampshire. SO53 1YF. U.K.

Helpline: +44 (0) 23 8049 4344

Sales Desk: +44 (0) 23 8049 4333

Internet: www.drapertools.com

E-mail: sales@drapertools.com

General Enquiries: (023) 8026 6355

Service/Warranty Repair Agent:

For aftersales servicing or warranty repairs, please contact the
Draper Tools Helpline for details of an agent in your local area.

YOUR DRAPER STOCKIST

MSMC0718

©Published by Draper Tools Limited.

No part of this publication may be reproduced, stored in a retrieval system or transmitted in any form or by any means, electronic, mechanical photocopying, recording or otherwise without prior permission in writing from Draper Tools Ltd.