



TB6B

Multifunction Balance Charger
Product Manual

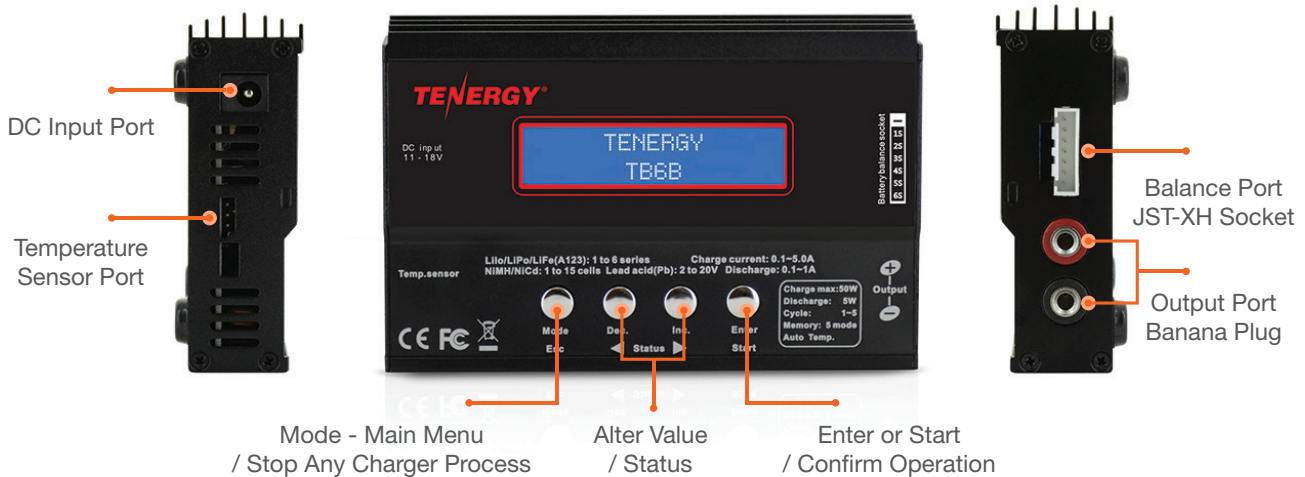

Table of Content

Introduction	2
Specifications	3
Key Features	4
Operating Instructions	6
Lithium Batteries (Li-Ion/LiPo/LiFe) 12	
NiMH/NiCd Batteries 14	
Pb Battery 15	
Save and Load Profiles 16	
Warning and Error Messages	17
Safety Message	18
Warranty	18

Introduction

Thank you for purchasing the TB6B Balance Charger. This product is a rapid charger with a high performance microprocessor and operating software. Please be sure to read this entire operating manual completely before you use this product for the first time, as it covers a wide range of information on operation and safety. It can be dangerous when batteries or chargers are mishandled. There are always risks of batteries catching fire and exploding when they are subjected to improper charging.



Specifications

Input Voltage Range	DC 10.5 – 18.0V
Display	Blue Backlight LCD
Controls	Four Buttons
Charge Current Range	0.1 – 5.0A
Discharge Current Range	0.1 – 1.0A
Charge Power Limited	Max. 50W
Discharge Power Limited	Max. 5W
Balance Current	Max. 250mA
Balance Tolerance	±0.01V
Battery Types/Cells	LiPo/Li-ion/LiFe: 1-6 cells NiMH/NiCd: 1-15 cells Pb (Lead Acid): 2-20V, 1-10 cells
Weight	260g
Dimension	130 x 85 x 26 mm

Key Features

Optimized Operating Software

When charging or discharging, TB6B has an 'AUTO' function that sets the feeding current or the cell count of the battery automatically. Especially for Li-ion/Li-Polymer batteries, it can prevent the over-charging which can lead to an explosion if improperly used. Every program in the unit is controlled with mutual links and communication for possible errors so it introduces maximum safety which can be set by the user.

Individual Voltage Balancer for Li-ion/Li-Polymer Batteries

TB6B has an individual-cell-voltage balancer inside, so it does not need a separate balancer when charging Li-ion/Li-Polymer batteries (Lilo/LiPo/LiFe).

Balance Individual Cells on Discharge

TB6B can also monitor and balance individual cells of the battery pack during the discharge process. If the voltage of any one cell varies abnormally, the process will be stopped and an error message will appear.

Accepts Various Battery Types

TB6B can accept three types of batteries - Lilo, LiPo, LiFe, NiCd, NiMH, and Pb. Please select the correct one before starting the process.

Battery 'Fast' and 'Storage' mode

Li-Ion/Li-Polymer batteries can be charged for special purposes. 'Fast' charge reduces the charging time of the battery and 'Storage' mode controls the final voltage of the battery, suitable for long term storage.

Data Store/Load

For your convenience, the device can store data for up to 5 different types of batteries. You can set the data to charge or discharge continually. This data can be selected at any time and the process can be executed without the use of a specific program setting.

Cyclic Charging/Discharging

Continually perform 1 to 5 cycles of charge $\leftarrow \rightarrow$ discharge for battery refreshing and balancing.

Robust Outer Aluminum Case

High-quality aluminum case is durable and very efficient at cooling down any internal heat.

Operating Instructions

Main Menu

When charger TB6B first powers up, the LCD screen will display the name of the charger for 2 seconds. To select the desired program, press the “Mode/Esc” button, and cycle through the options.

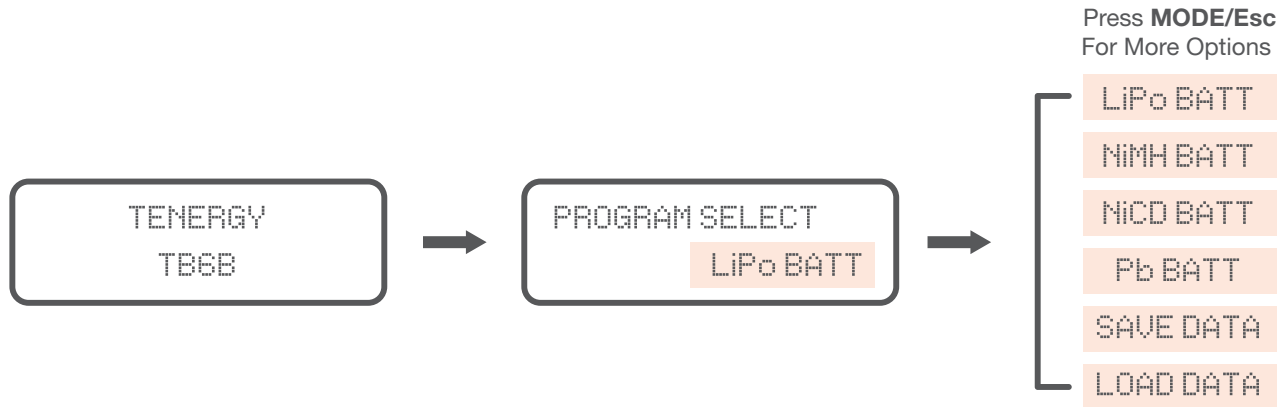

Initial Parameter Setup

Once the desired program is selected, hit the “Enter/Start” button to enter the submenu.
Once in the submenu, you can then hit “Enter/Start” to make the parameter numbers blink, and cycle through the options using the left (Dec.) and right (Inc.) “Status” keys.

*****Please be sure to select the correct type of Lithium battery (refer to table A on Page 11).
Misuse can lead to a fire or explosion*****

LiPo/Li-ion/LiFe Check Time

Normally, the charger can determine the cell count of the battery at the beginning of the charge/discharge process. However, when the battery is significantly discharged, the device may not correctly determine the cell count. When this happens, set the “check time” to 10 minutes, which should be enough for the device to then correctly determine the cell count.

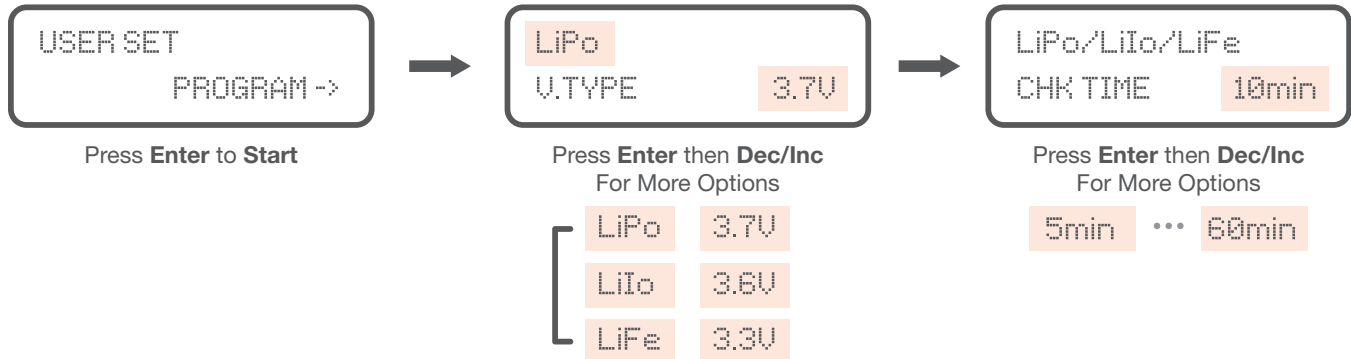

NiMH/NiCd Sensitivity

Delta Peak shows the trigger voltage for automatic charge termination of NiMH and NiCd batteries. D. Peak default setting is 12mV for NiCd and 7mV for NiMH. Please refer to the battery's technical specifications for the ideal value.

USB/Temp Select

For the optional thermometer attachment, this setting lets you change the temperature cut off.

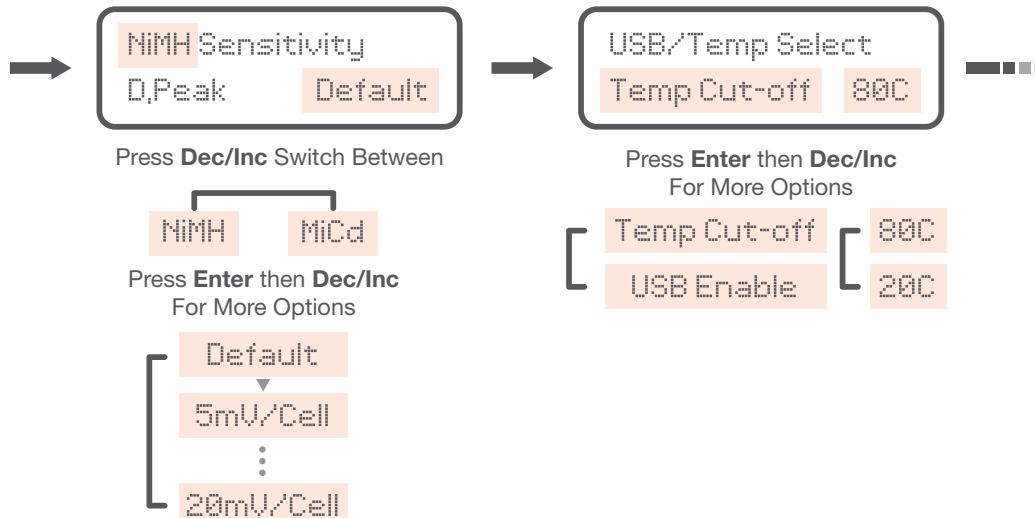

Waste Time

The cooling period between cycle charging and discharging.
Set more than 10 minutes to allow your battery time to cool-down between cycles.

Safety Timer

The back up alarm to ensure you don't overcharge your batteries.
You can turn this feature off or extend the timer.

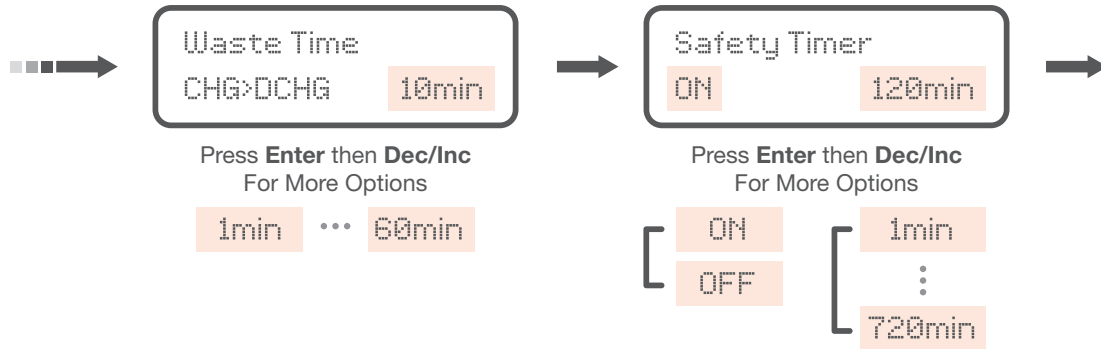

Capacity Cut-Off

An additional safety feature to prevent overcharging.
Set the max amount the charger can charge before shutting down.

Key Beep & Buzzer

Key Beep - Enable or Disable sound when pressing the buttons.
Buzzer - Enable or Disable alarm.

Input Power Low

The charger stops charging if the input voltage goes below this value.

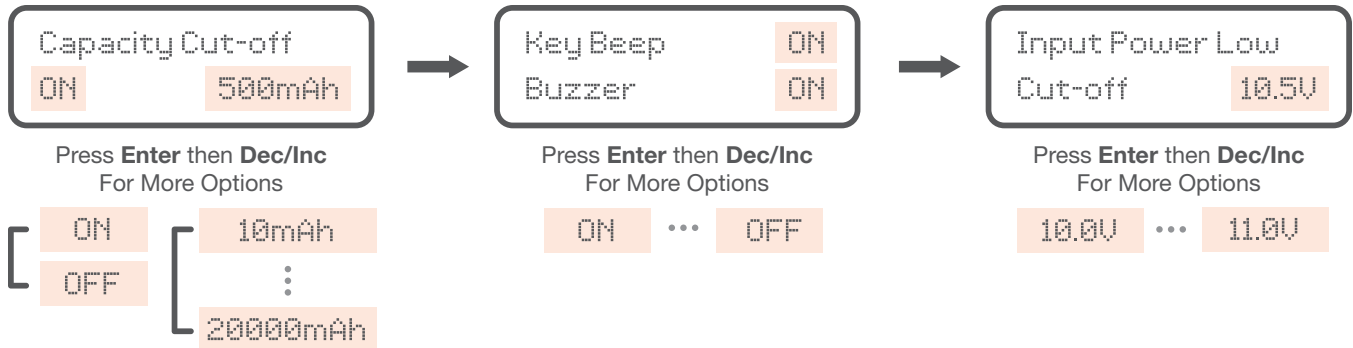

Table A

Battery Types	Li-Po	Li-Io	Li-Fe	NiMH	NiCd	Pd
Standard Voltage (V/cell)	3.70	3.60	3.30	1.20	1.20	2.00
Max. Charge Voltage (V/cell)	4.20	4.10	3.60	1.60	1.60	2.45
Maximum Charge Current	1C	1C	1C	1C	1C	0.2C
Min. Discharge Voltage (V/cell)	3.00	3.00	2.00	1.00	0.85	1.75

How to connect the wires



Auto charging mode



Balance charging / storage
/ discharge mode

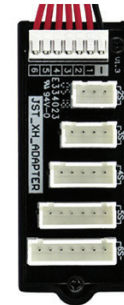

Individual cell
connection diagram

Lithium Batteries (Li-Ion/LiPo/LiFe)

Please follow the main instructions to select the correct type of battery and parameter value for your desired application.

CHARGE – This is for individual batteries and some special battery packs that do not have a balance port or cell count. The left side of the screen shows you the battery and the current you selected. The right side shows the mode and the cell count of the battery selected.

BALANCE – This is for 2-6 cell Lithium batteries with a balance port. The battery's individual cell balance connector should be inserted into the balance board connected to the right side of the charger.

FAST CHARGE – This is for rapid charging of your batteries. The final charge capacity will be slightly reduced, but the charging time will also be shortened.

STORAGE – This is for charging/discharging a battery which will not be used for some time. This will keep the battery at 40% of its normal capacity so as not to waste a full charge over time.

DISCHARGE – Although Lithium batteries do not need to be discharged, this function allows for a discharge of over 90%.

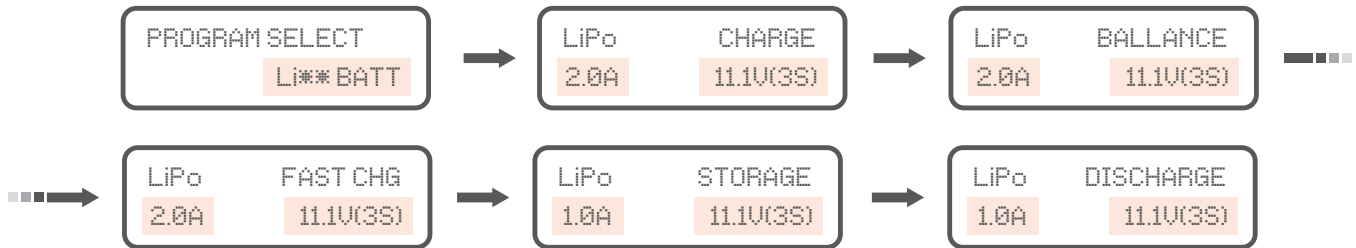

Selecting the Correct Cell Count

Once the type of battery and cell count is selected, press and hold the “**Enter/Start**” button for **2 sec**. This will take you to a screen to double check the cell count. “**R**” shows the number or cells found by the charger and “**S**” shows the number of cells the user selected. If they match, please continue by pressing the “**Enter**” button. If not, press “**Mode**” return to the previous screen, double check the battery’s specifications, and repeat the step.



Checking the Individual Voltage and Capacity

You will need to connect the balance plug. By using the “**Status**” buttons, you can check the safety capacity cut-off, safety timer, safety temperature, and the present voltage. You can also check the individual voltages of each battery while it is charging.

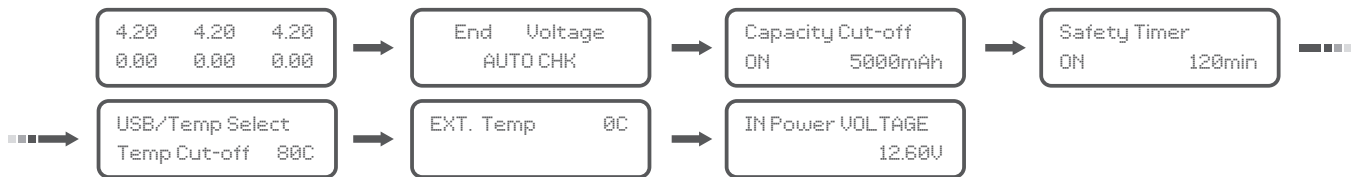

NiMH/NiCd Battery Program

Just as in the main screen, use the “**Mode**” and “**Status**” buttons to cycle through the options.

Charge mode – The default is “AUT” In this mode, the user needs to select the upper limit of the charge current to avoid issues. In “MAN” mode, the device will charge the battery at the current you previously set. To switch between AUT and MAN mode, press the ◀(left arrow) and ▶(right arrow) buttons on the charger simultaneously at the NiMH Charge Current setting screen.

Discharge mode – The recommended voltage of NiMH batteries is 1.0V/cell and NiCd is 0.85V/cell. Otherwise, please refer to the manufacturer’s recommendation for your battery.

Cycle mode – This mode will perform 1-5 cycles of Discharging/Charging the battery. Please use this mode for new NI batteries or long-term placement NI batteries. Only use this option if you are sure your battery needs it.

Once all of the steps above have been completed and verified, please press “**Enter/Start**” to begin the process.

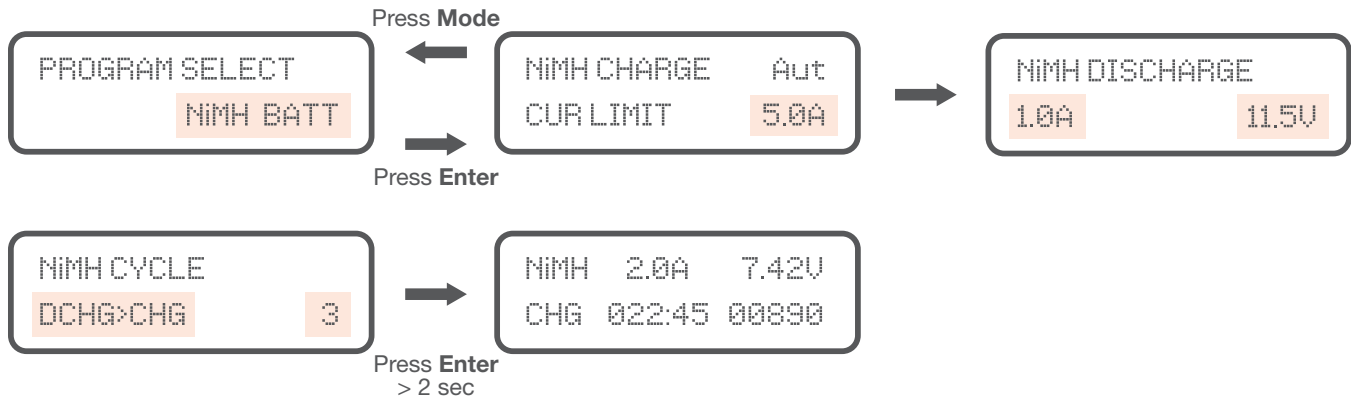

Pb Battery Program

Use this program for Pb batteries with voltages between 2 and 20V.
Please do not use rapid charging for Pb batteries.

Charging a Pb Battery

The left side of the screen will show the Amp of the battery, while the right side will show the voltage of the battery. After verifying that the voltage on the screen matches the voltage required by your batteries manufacturer, press and hold the “**Enter**” button for 2 seconds, and the process will start.

The charge can be stopped at any time by pressing the “**Mode/Esc**” button once.

Discharging a Pb Battery

Set the discharge current on the left side of the screen and final voltage desired on the right side. Then press and hold “**Enter**” to begin the process.

The charge can be stopped at any time by pressing the “**Mode/Esc**” button once.

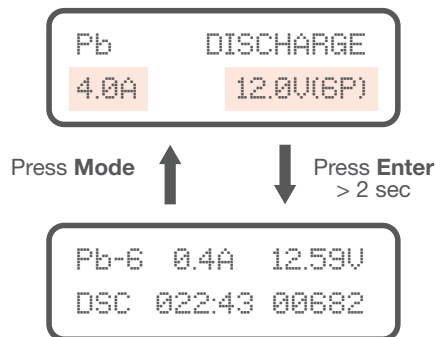
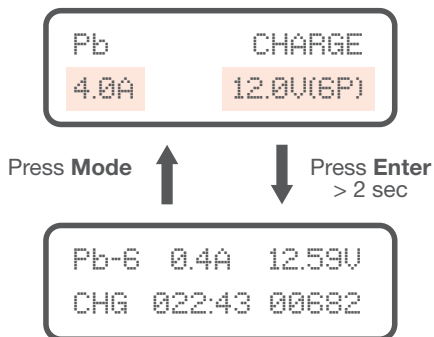

Save and Load Data Program

The charger can store data for up to 5 batteries.

Once set, you can automatically start the process without having to set it up every time.

Save Data

Press the “**Mode**” button until Save Data is selected on the screen, then press “**Enter**” to enter into the sub-menu. The blinking number shows you which data slot the saved profile will be in. This can be changed by pressing the left and right arrows, and selecting it by pressing “**Enter**” again.

Continue by selecting the type of battery, voltage, capacity, etc. and set the data by pressing the “**Enter**” button each time. Once completed, press and hold the “**Enter**” button to save the data.

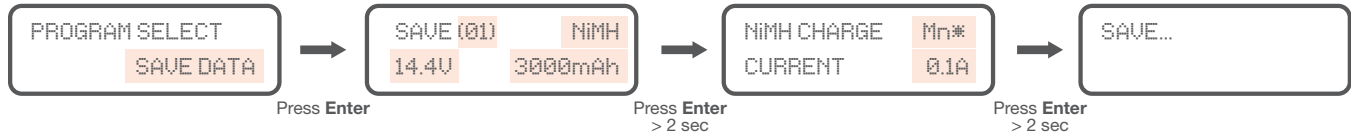

Load Data

Using the same process as the main menu, select the Load Data screen from the main menu. Then use the left and right arrow buttons to select the data you want to load.

Once selected, press and hold the “**Enter**” button for 2sec.

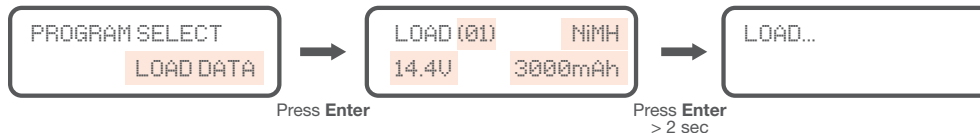

Warning and Error Messages

REVERSE POLARITY	The output cable is connected to a battery with incorrect polarity.
CONNECTION BREAK	Displayed when detecting an interruption in the connection between the battery and the output, or when voluntarily disconnecting the charge lead during operation.
SHORT ERR	A short-circuit occurred, please check the charging leads.
INPUT VOL ERR	The input voltage dropped below the limit.
VOL SELECT ERR	The voltage of the battery pack was selected incorrectly. Please verify and restart the process.
BREAK DOWN	A malfunction of the charger circuit has occurred.
BATTERY CHECK LOW VOLTAGE	The device detects a lower voltage than which was set. Please verify the cell count and restart the process.
BATTERY CHECK HIGH VOLTAGE	The device detects a high voltage then was set. Please verify the cell count and restart the process.
BATTERY VOLTAGE CELL LOW VOL	The voltage of one of the cells in the battery pack is too low. Please verify and restart the process.
BATTERY VOLTAGE CELL HIGH VOL	The voltage of one of the cells in the battery pack is too high. Please verify and restart the process.
BATTERY VOL ERR CELL CONNECT	There is a bad connection. Please check the connector cables.
TEMP OVER ERR	The internal temperature is too high. Please allow it some time to cool down.
CONTROL FAILURE	The unit needs to be repaired.

Safety Message

Prolong the life of the charger and keep it working properly, by following these safety tips.

- When the charger is running, please keep the device uncovered and in a well-ventilated area so it does not get too warm. This is especially true if you're discharging a battery.
- Do not store or use in an environment colder than 41°F (5°C) or hotter than 122°F (50°C).
- Do not store or use in a wet or corrosive environment.
- Keep all flammable and volatile materials away from the device.
- Take care of the charger by not letting it fall or get shaken.
- Do not attempt to use voltage higher than recommended by the battery manufacturer.
- Ensure that the type and voltage of the battery is properly selected. Do not charge different batteries at the same time.
- This device is made for charging one battery pack. Please purchase separate accessories for multiple battery packs.
- Do not attempt to use this device on a non-rechargeable or damaged battery.
- Keep the charger away from pets and children at all times. Never leave this device unsupervised when connected to a power supply.

Warranty

Thank you for purchasing the TB6B balance charger. We guarantee this product to be free of manufacturing and assembly defects for a period of one year from the date of purchase. During that period, we will repair or replace free of service charges for products deemed defective due to manufacturing or assembly causes.

For any repair or replacement service, please first contact the reseller you purchased the product from. If the product was purchased directly from Tenergy, please contact us at service@tenergy.com. This warranty is not valid for any damages or subsequent damage arising from misuse, modification, or as a result of failure to observe the procedures outlined in this manual.

TENERGY[®]



© 2019 Tenergy Corporation