

BISSELL®

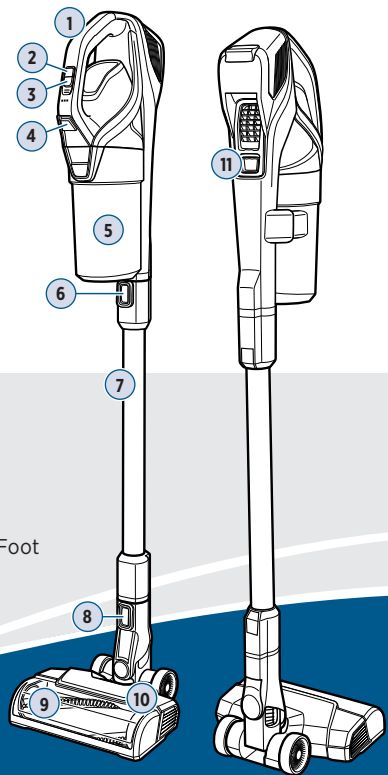

PET HAIR ERASER® SLIM CORDLESS MODEL 2907F

What's in the Box?.....	3
Assembly	3
Installing the Wall Storage & Charging Station	4
Charging the Battery	5
Using the Vacuum.....	6
Attaching Tools for Hand Vac Use	6
Emptying the Dirt Tank.....	7
Cleaning & Replacing the Filters.....	8
Maintaining the Brush Roll.....	9
Troubleshooting	10
Warranty	11



Product Overview

- | | |
|-------------------------------|-----------------------------------|
| 1. Hand Vacuum | 7. Extension Wand |
| 2. Power Button | 8. Foot Release Button |
| 3. Cleaning Mode Button | 9. Tangle-Free Brush Roll |
| 4. Tank Release Button | 10. Motorised Floor Cleaning Foot |
| 5. Dirt Tank | 11. Charging Port |
| 6. Hand Vacuum Release Button | |



Go online for a comprehensive walkthrough of your product!

This guide has everything you need to get ready for first use, including setting up, using and maintaining your machine, but online you'll find additional resources like tips and troubleshooting, videos, product registration, parts, and more. Go to **global.BISSELL.com**.

IMPORTANT SAFETY INSTRUCTIONS

READ ALL INSTRUCTIONS BEFORE USING YOUR APPLIANCE.

When using an electrical appliance, basic precautions should be observed, including the following:



WARNING

TO REDUCE THE RISK OF FIRE, ELECTRIC SHOCK OR INJURY:

- This appliance can be used by children aged from 8 years and above and persons with reduced physical, sensory or mental capabilities or lack of experience and knowledge if they have been given supervision or instruction concerning use of the appliance in a safe way and understand the hazards involved. Cleaning and user maintenance shall not be made by children without supervision.
- Children should be supervised to ensure that they do not play with the appliance.
- Keep hair, loose clothing, fingers, and all parts of body away from openings and moving parts of the appliance and its accessories.
- Do not use with damaged cord or plug.
- If the charger supply cord is damaged, it must be replaced by the manufacturer, its service agent or similarly qualified person in order to avoid a hazard.
- Do not incinerate the appliance even if it is severely damaged. The batteries can explode in a fire.
- The battery is to be disposed of safely.
- This appliance contains batteries that are only replaceable by skilled persons.
- Under abusive conditions, liquid may be ejected from the battery; avoid contact. If contact accidentally occurs, flush with water. If liquid contacts eyes, additionally seek medical help. Liquid ejected from the battery may cause irritation or burns.
- Recharge only with the charger specified by the manufacturer. A charger that is suitable for one type of battery pack may create a risk of fire when used with another battery pack.
- Use only with charger provided by manufacturer Mass Power, Model S018-1B262060HA.
- Unplug charger from electrical socket when not in use, before cleaning, maintaining or servicing the appliance, and if your appliance has an accessory tool with a moving brush, before connecting or disconnecting the tool.
- This appliance contains batteries that are non-user replaceable.
- Do not use with damaged cord or charger. If appliance is not working as it should, has been dropped, damaged, left outdoors, or dropped into water, return it to a service center.
- The battery must be removed from the appliance before it is scrapped.
- Do not immerse in water or liquid.
- Turn OFF all controls before unplugging.
- Do not pull or carry charger by cord, use cord as a handle, close door on cord, or pull cord around sharp edges or corners.
- Keep charger cord away from heated surfaces.
- To unplug, grasp the charger plug, not the cord.
- Do not handle charger plug or appliance with wet hands.
- Battery pack and charger base output terminals are not to be short-circuited.
- Do not charge the appliance outdoors.
- The appliance must be disconnected from the supply mains when removing the battery.
- Do not recharge, disassemble, heat above 60° C, or incinerate.
- Keep batteries out of reach of children.
- Dispose of used batteries promptly.
- Never put batteries in mouth. If swallowed, contact your physician or local poison control.
- Prevent unintentional starting. Ensure the switch is in the OFF-position before picking up or carrying the appliance. Carrying the appliance with your finger on the switch or energising appliance that have the switch on invites accidents.
- Do not use appliance that is damaged or modified. Damaged or modified batteries may exhibit unpredictable behavior resulting in fire, explosion or risk of injury.
- Do not expose appliance to fire or excessive temperature. Exposure to fire or temperature above 130° C may cause explosion.
- Follow all charging instructions and do not charge the appliance outside of the temperature range specified in the instructions. Charging improperly or at temperatures outside of the specified range may damage the battery and increase the risk of fire.
- Have servicing performed by a qualified repair person using only identical replacement parts. This will ensure that the safety of the product is maintained.
- Do not modify or attempt to repair the appliance except as indicated in the instructions for use and care.
- Keep the temperature range of between 4-30° C when charging battery, storing appliance or during use.
- Plastic film can be dangerous. To avoid danger of suffocation, keep away from children.
- Use only as described in this user guide.
- Use only manufacturer's recommended attachments.
- If appliance is not working as it should, has been dropped, damaged, left outdoors, or dropped into water; do not attempt to operate it and have it repaired at an authorised service center.
- Do not put any object into openings.
- Do not use with any opening blocked; keep free of dust, lint, hair, and anything that may reduce air flow.
- Use extra care when cleaning on stairs.
- Do not use to pick up flammable or combustible liquids, such as petroleum, or use in areas where they may be present.
- Do not pick up toxic material (chlorine bleach, ammonia, drain cleaner, etc.).
- Do not use appliance in an enclosed space filled with vapours given off by oil-based paint, paint thinner, some moth-proofing substances, flammable dust, or other explosive or toxic vapours.
- Do not pick up anything that is burning or smoking, such as cigarettes, matches or hot ashes.
- Do not use without filters in place.
- Do not use on wet surfaces. Do not expose to rain. Store indoors.



SAVE THESE INSTRUCTIONS

ORIGINAL INSTRUCTIONS. FOR OPERATION ON A 220-240 VOLT A.C. 50-60 HZ POWER SUPPLY ONLY.

THIS MODEL IS FOR HOUSEHOLD USE ONLY.

What's in the Box?

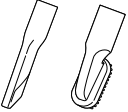

Standard accessories may vary by model. To identify what should be included with your purchase, please refer to the "Carton Contents" list located on the underside of the insert inside the carton.

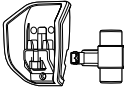
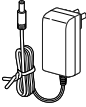
			
Hand Vacuum	Extension Wand	Foot	Crevice Tool & Dusting Brush

		
Optional Scented Filter	Wall Storage & Charging Station (Includes 3 Screws & Anchors)	Charger

Assembly

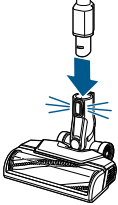
▶ Go to global.BISSELL.com for assembly videos.

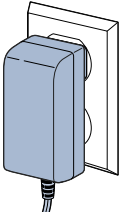
		
1. Connect the extension wand to foot. You'll hear a "click" when they're connected.	2. Connect the hand vacuum to the extension wand. You'll hear a "click" when they're connected.	3. Make sure to charge your stick vacuum before first use. Refer to page 5, "Charging the Battery" for instructions.

Installing the Wall Storage & Charging Station

▶ Go to global.BISSELL.com for more tips and video instructions.

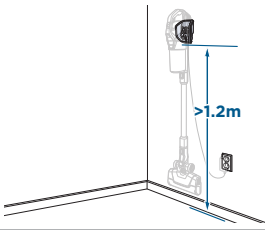

1. Install your Wall Storage & Charging Station at least 1.2 metres to allow the machine to hang comfortably.

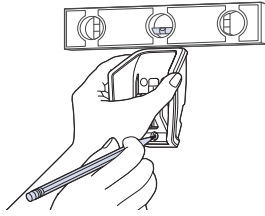

2. Using a level, mark the screw hole locations on the wall with a pencil.

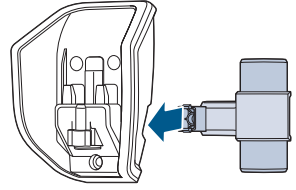

3. Insert tool holder on the side of the wall mount.

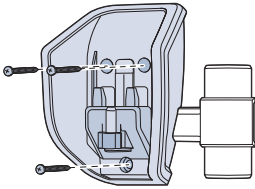

4. Screw the wall mount into a wall. Ensure the mount is high enough up off the ground for the vacuum to hang comfortably. Screwing into a wall stud will provide best support.

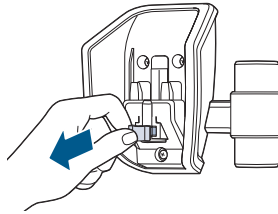

5. To install the charging cable, remove the power cable clip from the Wall Storage & Charging Station.

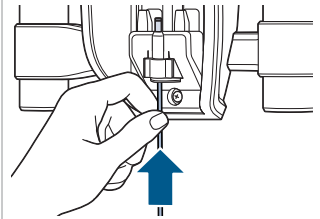

6. Insert the charging cable.

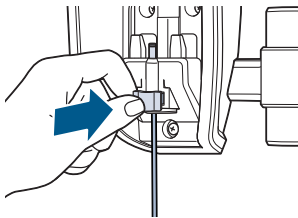

7. Secure the cable with the charging cable clip.



8. Hang the vacuum on the center storage piece and insert tools on the tool holder provided. Plug the power adapter into the wall and place the machine on the wall mount for charging.

Charging the Battery

▶ Go to global.BISSELL.com for additional how-to videos.

Charging the Hand Vacuum

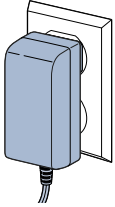
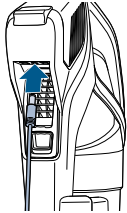
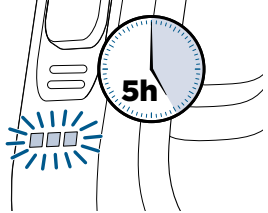
		
<p>1. Before first use, make sure to fully charge your stick vacuum. Plug the battery charger into the wall.</p>	<p>2. Plug the charger into the charging port on the back of the hand vacuum.</p>	<p>3. Let the hand vacuum charge for 5 hours or until all three sections of the battery charge icon are illuminated and flashing.</p>

Charging with the Wall Storage & Charging Station

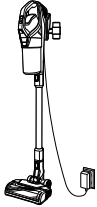
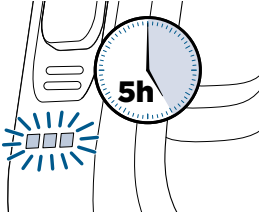
	
<p>1. Follow instructions for installing the Wall Storage & Charging Station. Once installed, hang the machine onto the station.</p>	<p>2. Let the hand vacuum charge for 5 hours or until all three sections of the battery charge icon are illuminated and flashing.</p>

Using the Vacuum

🔗 Looking for more guidance? Go to global.BISSELL.com for tips and 24-7 support.

Pet Hair Eraser® Slim Cordless can be used as a stick vacuum, hand vacuum or for extended reach with the hand vacuum and extension wand.

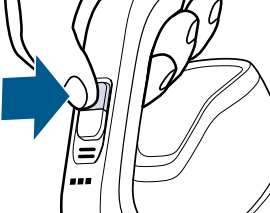
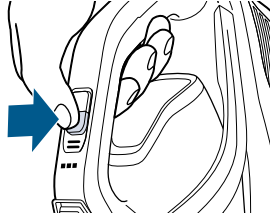
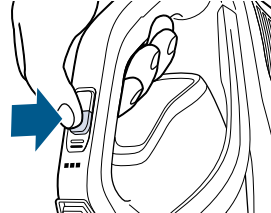
 A line drawing of the vacuum's handle. A blue arrow points to a circular power button on the left side of the handle.	 A line drawing of the vacuum's handle. A blue arrow points to a rectangular button with a double-hamburger icon on the right side of the handle.	 A line drawing of the vacuum's handle. A blue arrow points to the same rectangular button as in the previous diagram.
<p>1. Press the power button to begin cleaning and to turn OFF the machine when finished cleaning.</p>	<p>2. With the machine powered ON, press the cleaning mode button to toggle between the two modes:</p> <p>≡ Carpet Cleaning Mode Recommended for maximum suction providing the most powerful clean for your carpets. This is the default mode when the vacuum is turned ON.</p> <p>≡ Hard Floor Mode Recommended to achieve the longest run time. It's great for hard floors, low pile carpets and area rugs.</p>	

Attaching Tools for Hand Vac Use

🔗 Go to global.BISSELL.com for tips on above floor cleaning tools.

Clean stairs or furniture easily with the tools provided. Pair your desired tool with the hand vacuum or extension wand. **Note:** Ensure the vacuum is OFF when connecting tools.

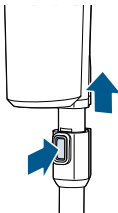
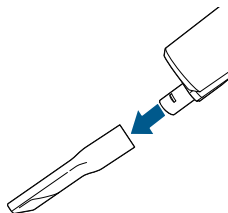
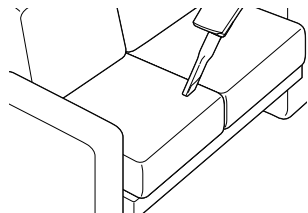
 A line drawing of the vacuum's handle. A blue arrow points to a small rectangular button on the side of the handle.	 A line drawing of a long, thin tool being inserted into the top of the vacuum's handle. A blue arrow points to the tool's tip.	 A line drawing of a corner of a piece of furniture or a staircase. A blue arrow points to the tool being used to clean the corner.
<p>1. To use as a hand vacuum, press the release button to disconnect it from the extension wand.</p>	<p>2. Attach your chosen tool.</p>	<p>3. Use the tool to clean furniture, stairs or other surfaces in your home.</p>

⚠️ WARNING Do not use your vacuum until you are familiar with all instructions and operating procedures.

Emptying the Dirt Tank

▶ More of a video person? Go to global.BISSELL.com for additional how-to videos.

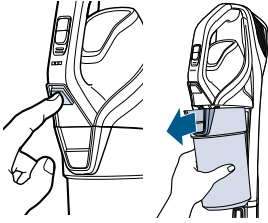

1. Turn OFF your machine. Remove the dirt tank from the hand vacuum by pressing the tank release button on the front of the tank.

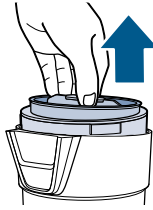

2. Grab the middle grip of the filter and pull up. This will activate a wiping feature to remove debris from the mesh filter screen. Twisting the grip will remove the filter only.

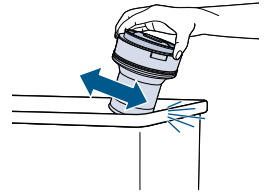

3. Fully remove the separator from the tank and tap the mesh screen on the side of the trash bin.

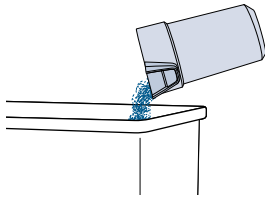

4. Dump dirt from the tank into the trash bin.

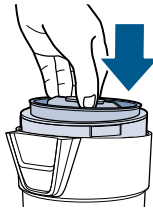

5. Slide the separator back into the tank, ensuring the notch is seated into the tank correctly.

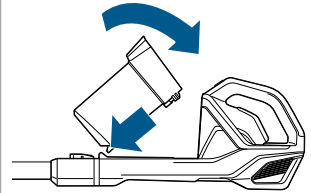

6. Reattach tank by guiding the bottom into the hook on the hand vacuum. Push into place.

⚠ WARNING Before using your vacuum, make sure that the dirt tank is in locked position and that the filter is in place. DO NOT operate your vacuum without the filter.

Cleaning & Replacing the Filters

Go to global.BISSELL.com for tips on maintaining and replacing your vacuum filter.

Pre-Motor Filter

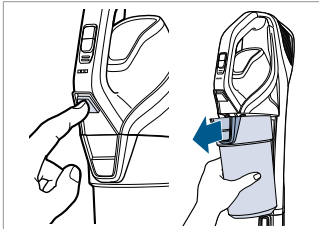

1. For best cleaning performance, always clean your filter after each use. Turn machine OFF. Remove dirt tank by pressing the tank release button and sliding the tank out.

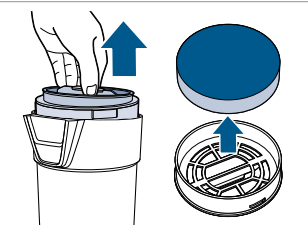

2. Twist top to remove filter frame from the separator. Remove the filter from the filter frame housing. Tap the filter against the side of a trash bin to remove dust and debris.



3. Rinse under warm water and squeeze to remove dirt. Lay out for 24 hours until completely dry. Reinsert filter into the frame with the tag side touching the frame.

Post-Motor Filter

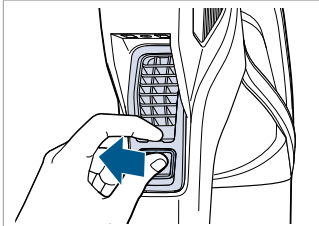

4. To clean the post-motor filter located on the back of the hand vac, turn OFF machine. Pinch the latch on the filter cover to remove.

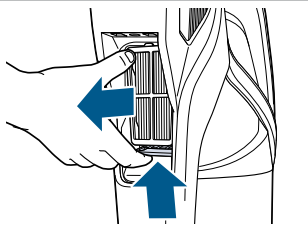

5. Press up on the bottom tab to pull filter out.



6. If there's debris on the filter, tap it on a trash bin and rinse under warm water. Let dry for at least 24 hours before putting it back in the vacuum and replacing the filter cover.

⚠ WARNING Before using your vacuum, make sure that the dirt tank is in locked position and that the filter is in place. DO NOT operate your vacuum without the filter.

Maintaining the Brush Roll

Go to [global.BISSELL.com](https://www.global.BISSELL.com) for tips on maintaining and replacing your vacuum.

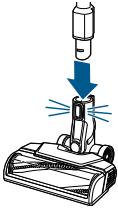

1. Turn the machine OFF and press the foot release button to disconnect the motorised cleaning foot.

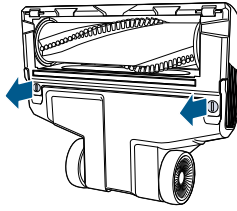

2. Use a flathead screwdriver or coin to twist the bottom screws counter-clockwise and release the brush roll side covers.

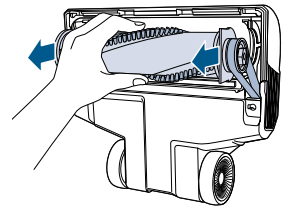

3. Remove the brush and clear any debris from brush, brush housing and the air suction channel.

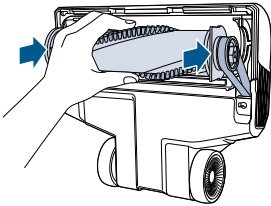

4. Reattach brush roll by inserting into the belt and pressing in to place.

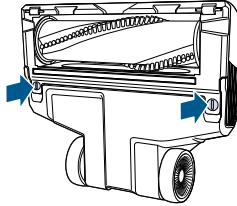





5. Attach and secure brush roll cover by using flathead screwdriver to twist the screws clockwise.

Troubleshooting

Below are some of the issues you may run into. If you don't see the issue you're experiencing below, visit global.BISSELL.com.

Problem	Possible Cause	Remedies
Vacuum won't pick up dirt	Filters are dirty.	Remove and rinse pre- and post-motor filters. Allow enough time for them to dry completely before reinserting.
	There is a clog in the vacuum.	Remove the foot and extension wand from the hand vacuum. Check for debris buildup or clogs in each of these sections. Clear any debris or clogs before reassembling.
	Dirt tank is not seated correctly.	Remove the tank and reseal properly.
Dirt is escaping from the vacuum	Dirt tank is full.	Empty the tank.
	Filters are missing or dirty.	Check to see if the pre- and post-motor filters are in place and clean. Clean filters if necessary.
	There is a clog in the vacuum.	Remove the foot and extension wand from the hand vacuum. Check for debris buildup or clogs in each of these sections. Clear any debris or clogs before reassembling.
Vacuum won't charge	Wrong charger is being used.	Use only the charger that comes with the machine.
	Charger is not plugged into the machine properly.	Remove the charger and reinstall to the hand vacuum.

Errors

			
<p>Behavior: 3 flashes, then solid.</p> <p>Cause: Suction motor fault.</p> <p>Remedy: Turn machine OFF. Check and clean filters. Check for and clear any clogs.</p>	<p>Behavior: 3 flashes, then solid.</p> <p>Cause: Brush roll stall.</p> <p>Remedy: Turn machine OFF. Check and clean filters. Clear debris or clogs from brush roll.</p>	<p>Behavior: Flashing.</p> <p>Cause: Charger issue.</p> <p>Remedy: Turn machine OFF. Unplug the charging cable from the wall and check for cable damage. If charging cable is damaged please contact Consumer Care.</p>	<p>Behavior: 3 flashes, then solid.</p> <p>Cause: Battery issue.</p> <p>Remedy: Turn machine OFF and remove the charger. Contact Consumer Care.</p>

If the remedies do not solve the problems, contact Consumer Care.

⚠️ WARNING To reduce the risk of fire, electric shock or injury, turn power OFF and disconnect plug from electrical outlet before performing maintenance or troubleshooting. Other maintenance or service not included in the manual should be performed by an authorized service representative.

Warranty

This warranty gives you specific legal rights, in addition to rights you may have under the *Australian Consumer Law*. If you need additional instruction regarding this warranty or have questions regarding what it may cover, please contact your local BISSELL® Consumer Care on the details set out below.

It may be necessary to obtain some of your personal information, such as a mailing address, to fulfill terms of this warranty. Any personal data will be handled pursuant to BISSELL's Privacy Policy, which can be found at global.BISSELL.com/privacy-policy.

BISSELL® Two-Year Warranty

Subject to the *conditions identified below, BISSELL will repair or replace (with new, refurbished, lightly used, or remanufactured components or products), at BISSELL's option, free of charge from the date of purchase by the original purchaser, for two years any defective or malfunctioning part due to manufacturer defect. This warranty applies to product used for personal purposes, and not commercial or rental service. This warranty does not apply to fans or routine maintenance or consumable components such as filters, belts, brush rolls, etc., damage or malfunction caused by negligence, abuse, neglect, unauthorised repair, or any other use not in accordance with the user guide. BISSELL recommends that the original packaging be kept for the duration of the warranty period in case such need arises within the warranty period that the item needs repacking and transportation.

*Conditions of Warranty

Subject to whether such loss is reasonably foreseeable, BISSELL and its in-country distributors are not liable for incidental or consequential damages of any nature associated with the use of this product.

This warranty is in addition to other rights or remedies under law. Nothing in this warranty excludes, limits or modifies any liability of BISSELL which is imposed by law, or limits or modifies any remedy available to the consumer which is granted by law. To make a claim under this warranty contact BISSELL Australia PTY LTD (details below). Contact BISSELL prior to returning any goods. Where agreed, BISSELL will reimburse reasonable postage / handling costs (if any) for returning goods to BISSELL. To claim expenses incurred in making a claim under this warranty please provide BISSELL with a copy of the receipt of the expenses by email or post.

For Australian Consumers Only: Our goods come with guarantees that cannot be excluded under the *Australian Consumer Law*. You are entitled to a replacement or refund for a major failure and compensation for any other reasonably foreseeable loss or damage. You are also entitled to have the goods repaired or replaced if the goods fail to be of acceptable quality and the failure does not amount to a major failure.

Consumer Care

Australia

Telephone: 1300 247 735

Website: www.BISSELL.com.au

New Zealand

Telephone: 0800 247 735

Website: www.BISSELL.co.nz

But wait, there's more!

Join us online for a complete guide to your new product, including troubleshooting, parts and more. **Go to [global.BISSELL.com](https://www.global.bissell.com).**



INFO



VIDEOS



PARTS



©2021 BISSELL Inc. All rights reserved.
Part Number 1624201 01/21 RevC