

Commercial Electric Water Heater Installation & Service Manual Models: CHV and CHH 0150 - 1000

⚠WARNING: If the information in this manual is not followed exactly, a fire or explosion may result causing property damage, personal injury, or loss of life.



⚠WARNING

This manual must only be used by a qualified heating installer /service technician. Read all instructions, including this manual, before installing. Perform steps in the order given. Failure to comply could result in severe personal injury, death, or substantial property damage.



Save this manual for future reference.

Contents

HAZARD DEFINITIONS	2	7. CONTROL SYSTEM OPERATION	
PLEASE READ BEFORE PROCEEDING	3	Heating Banks Operation	21
INTRODUCTION	4	Control System Features	21
RATINGS	5	Control System Navigation.....	21
1. FEATURES AND COMPONENTS		The Display Screen.....	21
CHV Models (Vertical Water Heater)	6	Control System Operation Tables	22-23
CHH Models (Horizontal Water Heater).....	7	Temperatures Menu	24
Dimensions and Capacities Data	8-9	Temperature Screens	25
2. DETERMINE WATER HEATER LOCATION		Water Heater Status Menu	26
Facts to Consider About the Location.....	10-11	Economy Mode Setup Menu.....	27
3. INSTALLATION		Economy Mode Settings Tables	28-30
Mixing Valve Usage	12	Alarm Output Setup Menu	31
Chemical Vapor Corrosion	12	Display Settings Menu	31
Circulating Pump	12	Heater Information Menu	32
Insulation Blankets	12	Current Fault / Alert Menu.....	32
Temperature - Pressure Relief Valve.....	12-13	Fault History Menu	32
Closed Water Systems.....	13	Fault Occurrence Menu.....	33
Thermal Expansion	13	Restore Factory Defaults Menu	34
4. ELECTRICAL		8. MAINTENANCE	
General.....	14	General.....	35
Branch Circuit.....	14	Anode Rod Inspection.....	35
Heater Circuits.....	14	Flushing the Water Heater	35
Power Circuit.....	14	Sediment Removal.....	36
Amp Chart	15-16	Lime Scale Removal	36
Electrical and Recoveries Data	17-18	9. TROUBLESHOOTING	
5. OPERATION		Checklist.....	37
General.....	19	10. DIAGRAMS	
Filling the Water Heater	19	Wiring Diagram	38-39
Initial Start-up	19	Revision Notes	Back Cover
Draining the Water Heater	19		
6. TEMPERATURE REGULATION			
High Temperature Limit Controls (ECO).....	20		
Thermostat Controls.....	20		
Temperature Adjustment.....	20		

Hazard definitions

The following defined terms are used throughout this manual to bring attention to the presence of hazards of various risk levels or to important information concerning the life of the product.

⚠ DANGER

DANGER indicates an imminently hazardous situation which, if not avoided, will result in death or serious injury.

⚠ WARNING

WARNING indicates a potentially hazardous situation which, if not avoided, could result in death or serious injury.

⚠ CAUTION

CAUTION indicates a potentially hazardous situation which, if not avoided, may result in minor or moderate injury.

CAUTION

CAUTION used without the safety alert symbol indicates a potentially hazardous situation which, if not avoided, may result in property damage.

NOTICE

NOTICE indicates special instructions on installation, operation, or maintenance that are important but not related to personal injury or property damage.

Please read before proceeding

⚠ WARNING

Installer – Read all instructions before installing. Perform steps in the order given.

Have this water heater serviced/inspected by a qualified service technician, at least annually.

Failure to comply with the above could result in severe personal injury, death, or substantial property damage.

NOTICE

When calling or writing about the water heater – Please have the water heater model and serial number from the water heater rating plate.

Consider piping and installation when determining water heater location.

Any claims for damage or shortage in shipment must be filed immediately against the transportation company by the consignee.

Factory warranty (shipped with unit) does not apply to units improperly installed or improperly operated.

⚠ WARNING

Failure to adhere to the guidelines on this page can result in severe personal injury, death, or substantial property damage.

⚠ WARNING

If the information in this manual is not followed exactly, a fire or explosion may result causing property damage, personal injury, or loss of life.

⚠ WARNING

The California Safe Drinking Water and Toxic Enforcement Act requires the Governor of California to publish a list of substances known to the State of California to cause cancer, birth defects, or other reproductive harm, and requires businesses to warn of potential exposure to such substances.

This product contains a chemical known to the State of California to cause cancer, birth defects, or other reproductive harm. This water heater can cause low level exposure to some of the substances listed in the Act.

When servicing the water heater –

- To avoid electric shock, disconnect electrical supply before performing maintenance.
- To avoid severe burns, allow the water heater to cool before performing maintenance.
- Do not use this water heater if any part has been under water. The possible damage to a flooded appliance can be extensive and present numerous safety hazards. Any appliance that has been under water must be replaced.

Grounding Instructions –

- This water heater must be grounded in accordance with the National Electrical Code and/or local codes. These must be followed in all cases. Failure to ground this water heater properly may also cause erratic control system operation on ELECTRONIC CONTROL models.
- This water heater must be connected to a grounded metal, permanent wiring system, or an equipment grounding conductor must be run with the circuit conductors and connected to the equipment grounding terminal or lead on the water heater.

Hydrogen Gas (Flammable) –

Hydrogen gas can be produced in a hot water system, served by this heater, that has not been used for a long period of time (generally two weeks or more). Hydrogen gas is extremely flammable. To reduce the risk of injury, it is recommended that the hot water faucet be opened for several minutes at the kitchen sink before using any electrical appliance connected to the hot water system. If hydrogen is present, there will probably be an unusual sound, such as air escaping through the pipe as water begins to flow.

⚠ WARNING

There should be no smoking or open flame near the faucet at the time it is open.

⚠ WARNING

Flammable hydrogen gases may be present.

⚠ WARNING

Keep all ignition sources away from faucet when turning on hot water.

Introduction

Thank you for purchasing this water heater. Properly installed and maintained, it should give you years of trouble-free service.

Abbreviations Used

Abbreviations found in this instruction manual include:

- ANSI - American National Standards Institute
- ASME - American Society of Mechanical Engineers
- NEC - National Electrical Code
- NFPA - National Fire Protection Association
- UL - Underwriters Laboratory
- CSA - Canadian Standards Association
- AHRI - Air Conditioning, Heating, & Refrigeration Institute

Preparing for the Installation

⚠ WARNING

Before removing any access panels or servicing the water heater, make sure the electrical supply to the water heater is turned OFF. Failure to do this could result in death, serious bodily injury, or property damage.

Read the *Please read before proceeding...* section of this manual first, then read the entire manual carefully. If you don't follow the safety rules, the water heater may not operate safely, which could result in death, serious bodily injury, and/or property damage.

This manual contains instructions for the installation, operation, and maintenance of the water heater. It also contains warnings throughout the manual that you must read and be aware of. All warnings and all instructions are essential to the proper operation of the water heater and your safety. Read the entire manual before attempting to install or operate the water heater.

General outline diagrams are in this manual. These diagrams will serve to provide the installer with a reference for basic installation of this product. It is necessary that all water piping and electrical wiring be installed and connected as shown in the diagrams.

Be sure to turn power OFF when working on or near the electrical system of the water heater. Never touch electrical components with wet hands or when standing in water. When replacing fuses always use the correct size for the circuit. Use the same size and type of fuse when replacing.

Detailed installation diagrams are in this manual. These diagrams will serve to provide the installer with a reference for the materials and method of piping suggested. It is necessary that all water piping and electrical wiring be installed and connected as shown in the diagrams.

The principle components of the heater are identified on pages 6 and 7. The model and rating plate on page 5 interprets certain markings into useful information. Both of these references should be used to identify the heater, its components, and optional equipment.

The installation must conform with these instructions and the local code authority having jurisdiction and the requirements of the power company. In the absence of local codes, the installation must comply with the current editions of the National Electrical Code, NFPA 70 or the Canadian Electrical Code, CSA C22.1. The National Electrical Code may be ordered from: National Fire Protection Association, 1 Batterymarch Park, Quincy, MA 02269. The Canadian Electrical Code is available from the Canadian Standards Association, 8501 East Pleasant Valley Road, Cleveland, OH 44131.

If after reading this manual you have any questions or do not understand any portion of the instructions, call the telephone number on the back cover for further assistance. Please have the model and serial number of the unit available for the technician.

Carefully plan your intended placement of the water heater. Examine the location to ensure the water heater complies with the *Determine Water Heater Location* section in the manual.

Clearance must be maintained so that the heating elements may be removed for servicing after installation.

Installation and service of this water heater requires ability equivalent to that of a licensed tradesman or qualified agency in the field involved. Plumbing and electrical work are required.

For installation in California, this water heater must be braced or anchored to avoid falling or moving during an earthquake. See instructions for correct installation procedures. Instructions may be obtained from the California Office of the State Architect, 1102 Q Street, Suite 5100, Sacramento, CA 95811.



Massachusetts Code requires this water heater to be installed in accordance with Massachusetts 248-CMR 2.00: State Plumbing Code and 248-CMR 5.00.



Ratings



All models are listed by Underwriters Laboratories Inc.

Rating & Model Plate

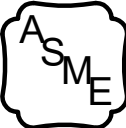
 LOW LEAD CONTENT		ELECTRIC STORAGE TANK WATER HEATER				 LISTED 932N	
MODEL NUMBER		SERIAL NUMBER			ITEM ID/PART NUMBER		
VOLTS, AC	PHASE	KILOWATTS UPPER	KILOWATTS LOWER	TOTAL KW CONNECTED	CAPACITY US GALLONS	MAX WORKING PRESSURE	
VOLTS, AC	KILOWATTS UPPER	KILOWATTS LOWER	TOTAL KW CONNECTED		CIRCUIT		
<div style="border: 1px solid black; width: 60%; margin: 0 auto; padding: 10px;">ADDRESS</div>							
<div style="border: 1px solid black; width: 80%; margin: 0 auto; padding: 5px;">MODEL NUMBER BARCODE</div>				<div style="border: 1px solid black; width: 80%; margin: 0 auto; padding: 5px;">SERIAL NUMBER BARCODE</div>			
<small>MODEL NUMBER XXXXXXXX</small>				<small>SERIAL NUMBER 123456789</small>			
L							

	 123456
HLW	CERTIFIED BY LC
	MAWP XXX PSI
	MAX ALLOWABLE INPUT
	XXXXXXXXXX BTU/HR
	S/N 123456789
	YEAR BUILT YYWW
	CRN XXXXXXXXXXXXXXXXXXXX



1 Features and Components

CHV Models (Vertical Water Heater)

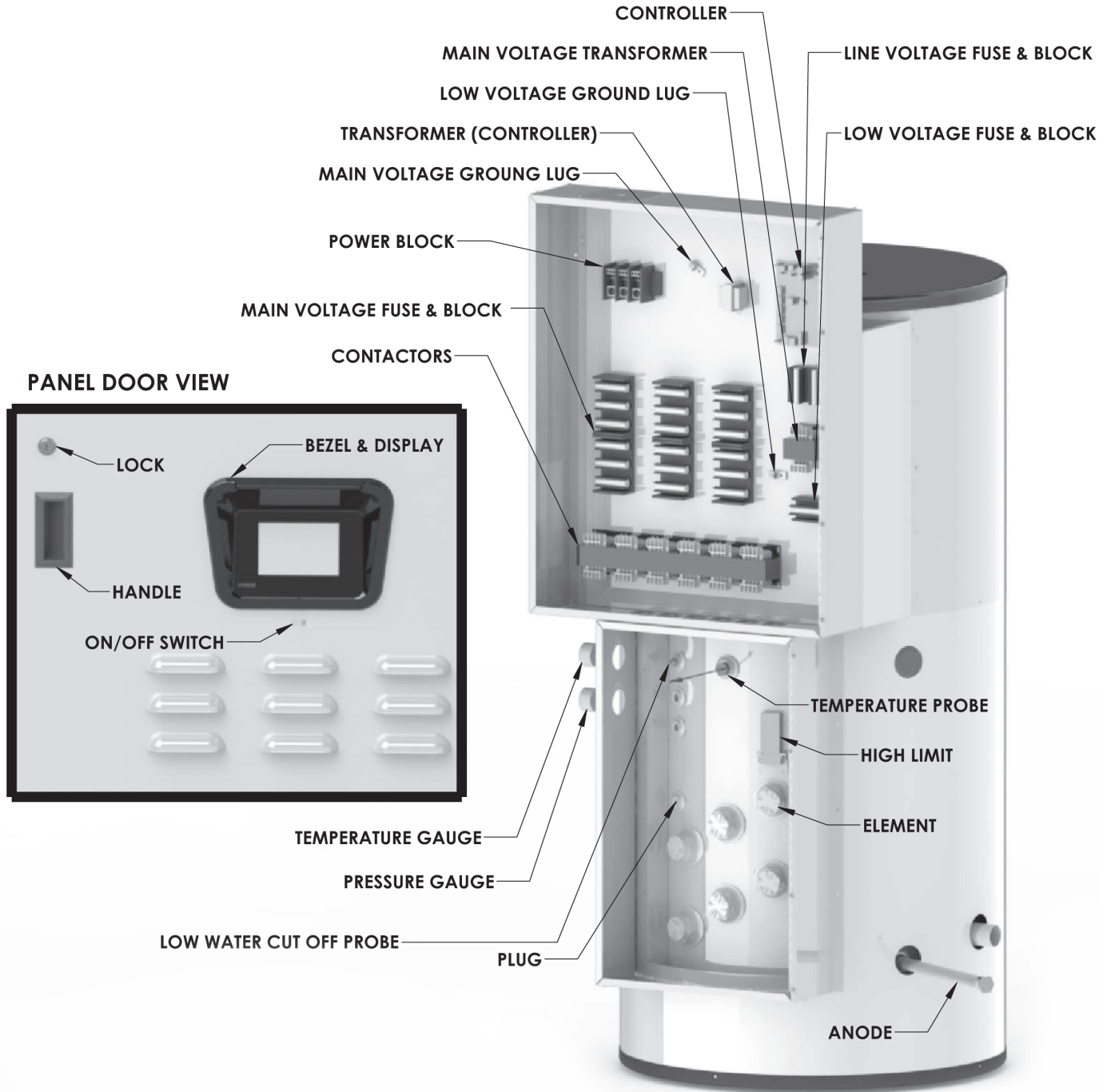

Note: Model shown for illustration purposes only. Actual configurations may vary.

1 Features and Components

CHH Models (Horizontal Water Heater)

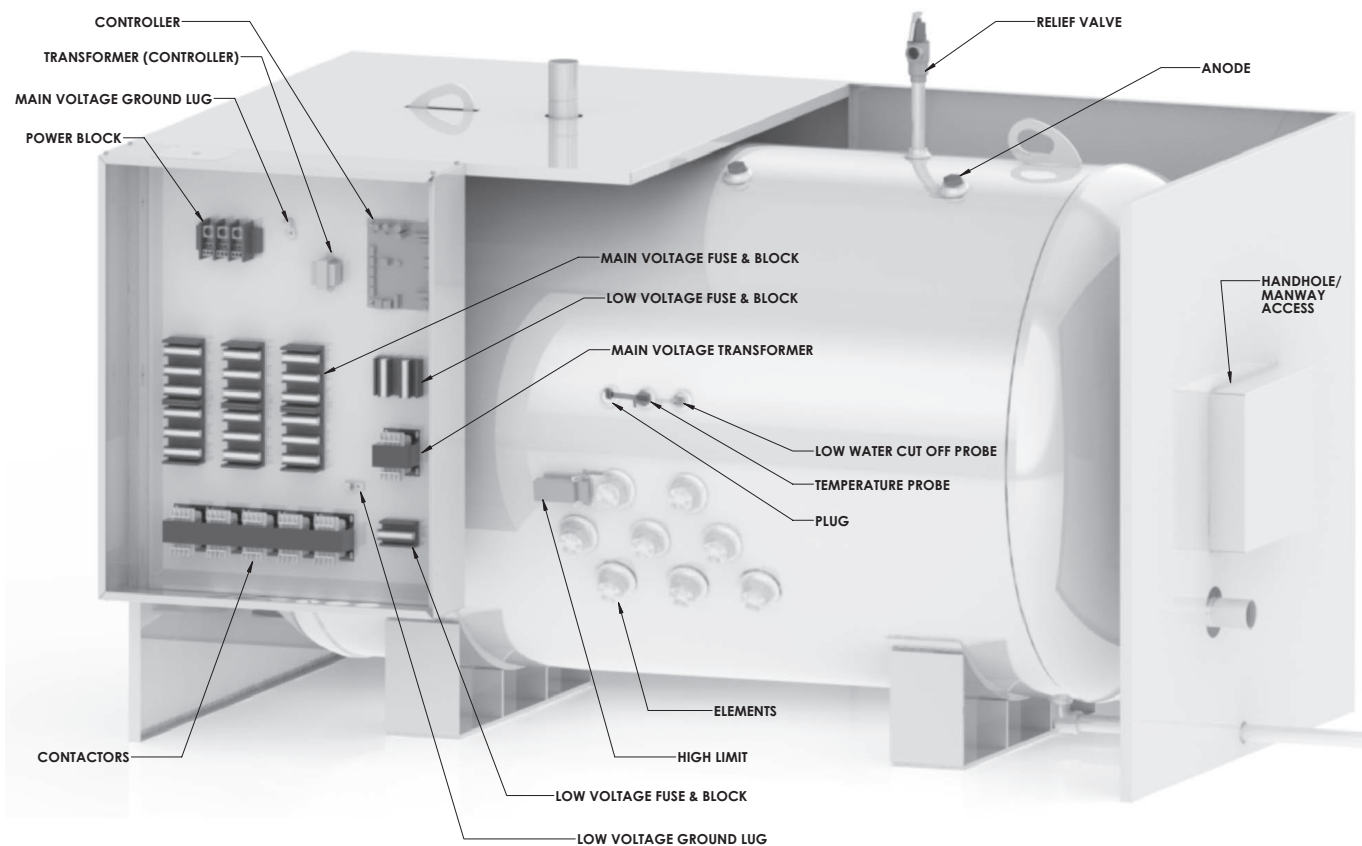

Note: Model shown for illustration purposes only. Actual configurations may vary.

1 Features and Components *(continued)*

Specifications Data

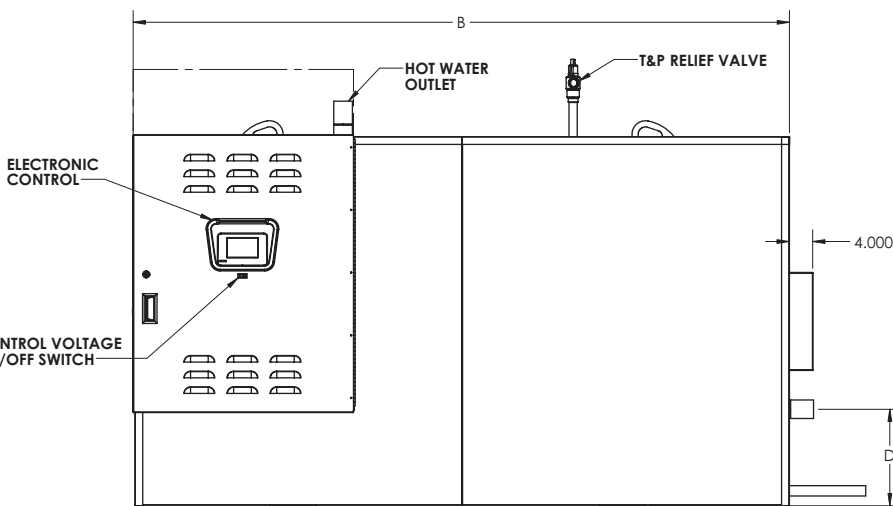
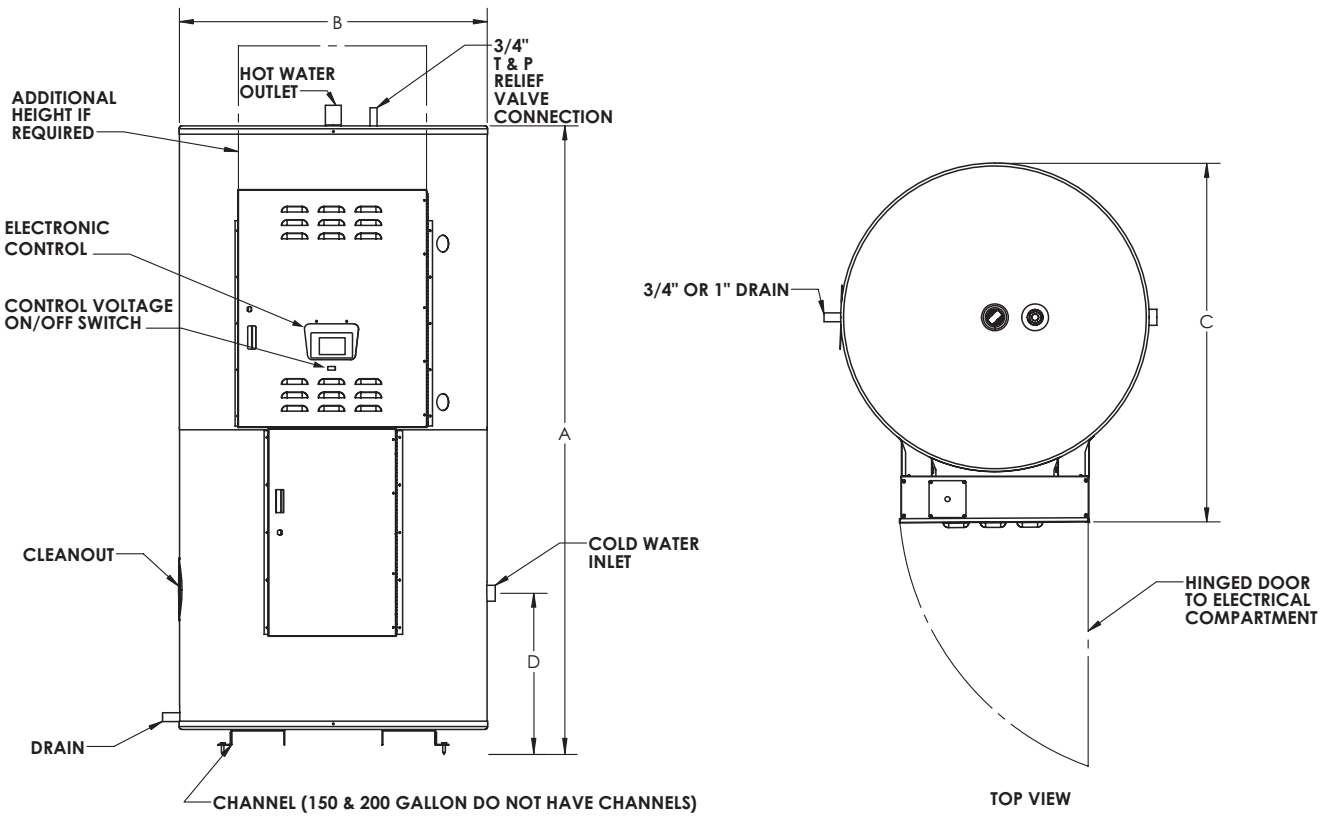

A & D ELEVATION FROM FINISHED FLOOR

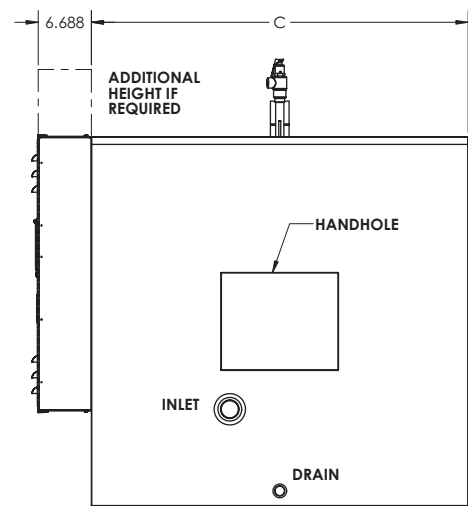

EXTRA PANEL BOX MAY BE NECESSARY FOR INPUTS HIGHER THAN 72KW. CONSULT FACTORY.

1 Features and Components *(continued)*

Specifications Data *(continued)*

Model*	Maximum KW Input	Height A	Width (Length) B	Depth C	D	Inlet Water Connection	Outlet Water Connection	Shipping Weight (lbs)
VERTICAL ROUND ELECTRIC STORAGE HEATER								
CHV0150	162	65 1/2"	32"	38 3/4"	8 1/4"	1 1/2"	1 1/2"	650
CHV0200	216	78"	32"	38 3/4"	8 1/4"	1 1/2"	1 1/2"	750
CHV0250	270	91 3/8"	34"	40 3/4"	19 1/4"	1 1/2"	1 1/2"	1,165
CHV0300	162	80"	40"	46 3/4"	20 3/4"	2"	2"	1,350
CHV0400	162	80"	46"	52 3/4"	22 1/4"	2"	2"	1,590
CHV0500	270	91 3/8"	46"	52 3/4"	22 1/4"	2"	2"	1,700
CHV0600	270	92 5/8"	52"	58 3/4"	24 1/4"	2 1/2"	2 1/2"	2,010
CHV0800	432	104"	52"	58 3/4"	24 1/4"	2 1/2"	2 1/2"	2,450
CHV1000	486	128"	52"	58 3/4"	24 1/4"	2 1/2"	2 1/2"	3,160
VERTICAL SQUARE ELECTRIC STORAGE HEATER								
CHV1250	648	132 1/2"	64 1/2"	64 1/2"	23 1/4"	3"	3"	3,560
CHV1500	918	128 1/2"	70 1/2"	70 1/2"	25 1/4"	3"	3"	4,120
CHV2000	918	140 1/2"	76 1/2"	76 1/2"	27 1/4"	3"	3"	4,350
CHV2500	918	146 1/2"	82 1/2"	82 1/2"	29"	3"	3"	5,750
HORIZONTAL SQUARE ELECTRIC STORAGE HEATER								
CHH0150	162	37"	68 1/2"	34 1/4"	12"	2"	2"	1,180
CHH0200	198	37"	78"	34 1/4"	12"	2"	2"	1,370
CHH0250	240	39"	90 1/4"	36 1/4"	13"	2"	2"	1,450
CHH0300	300	45"	78 1/4"	42 1/4"	14 3/4"	2"	2"	1,530
CHH0400	324	52"	78 1/4"	48 1/4"	16"	2"	2"	1,750
CHH0500	432	52"	90 3/4"	48 1/4"	16"	2"	2"	1,860
CHH0600	414	58"	90 3/4"	54 1/4"	13 1/2"	2 1/2"	2"	2,340
CHH0800	468	58"	102 1/4"	54 1/4"	13 1/2"	2 1/2"	2"	2,850
CHH1000	648	58"	126 1/4"	54 1/4"	13 1/2"	2 1/2"	2"	3,040
CHH1250	648	64"	130 1/4"	60 1/4"	15"	3"	3"	3,750
CHH1500	918	70"	126 1/4"	66 1/4"	16"	3"	3"	4,340
CHH2000	918	76"	137 1/4"	72 1/4"	17 1/2"	3"	3"	4,580
CHH2500	918	82"	144 1/4"	78 1/4"	16 1/2"	3"	3"	6,060

**FOR EASE IN ORDERING
BY MODEL NUMBER**

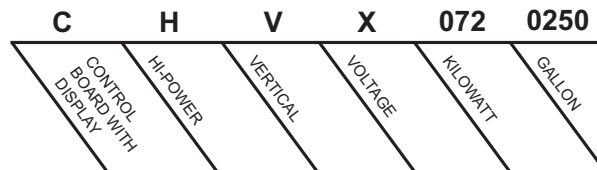

This unit is a Control Board with Display, Hi-Power, Vertical, 480 Volt, Three Phase, 72 Kilowatt, 250 Gallon Water Heater.



2 Determine Water Heater Location

Determine Water Heater Location

CAUTION

All water heaters eventually leak. Do not install without adequate drainage.

Carefully choose a location for the new water heater. The placement is a very important consideration for the safety of the occupants in the building and for the most economical use of the appliance.

Whether replacing an old water heater or putting the water heater in a new location, the following critical points must be observed. The water heater must be located:

1. On a level surface. Shim the channel-type skid base as necessary if leveling is required.
2. Near a floor drain. The heater should be located in an area where leakage of the tank or connections will not result in damage to the area adjacent to the heater or to lower floors of the structure. When such locations cannot be avoided, a suitable drain pan should be installed under the heater. The pan should be at least 2 inches deep, have a minimum length and width of at least 2 inches greater than the dimensions of the water heater, and should be piped to an adequate drain. The discharge opening of the relief valve should always be piped to an open drain.
3. Close to the point of major hot water usage and the power supply.

Hot water piping and branch circuit wiring should be as short as possible. Insulate hot and cold water piping where heat loss and condensation may be a problem.

Heater construction permits installation, maintenance, and service work to be performed through the element box door and control box door.

Suggested clearances from adjacent surfaces are 12 inches on top, 30 inches in front of access doors, 24 inches for cleanout/handhole/manway side, and 6 inches on the inlet water piping side.

The heater may be installed on or against combustible surfaces. The back may be placed flush against adjacent surfaces. Be sure to place the cover plates over the rear crating couplings before locating vertical model heaters that were shipped laying down. The heater may be installed in a confined space if adequate ventilation is provided.

The temperature of the space in which the water heater is installed must not go below 32°F or above 122°F.

2 Determine Water Heater Location *(continued)*

Figure 2-1 Clearances from Combustible Construction

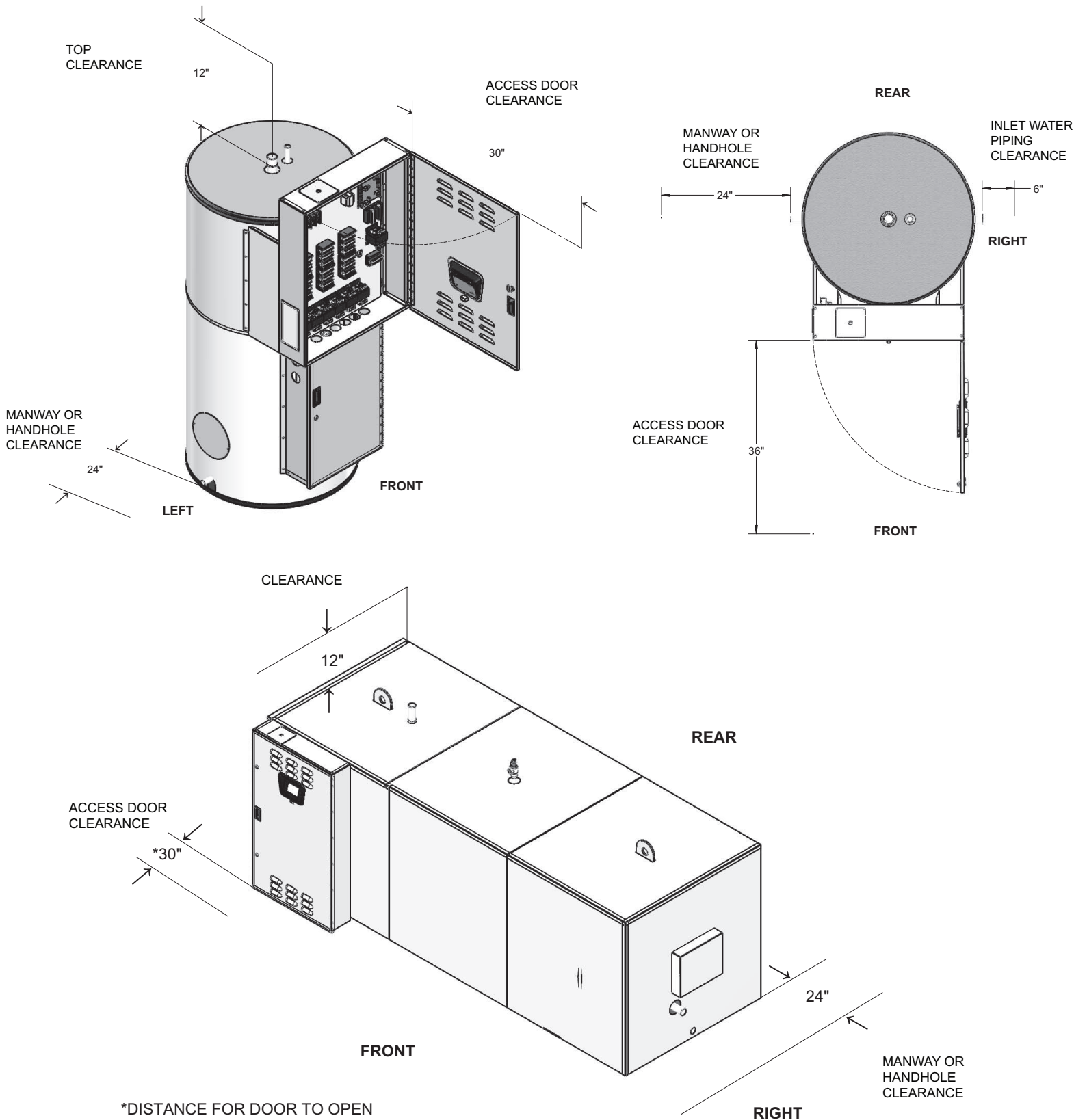

3 Installation

The installation must conform to these instructions and local code authority having jurisdiction. Grounding and electrical wiring connected to the water heater must also conform to the National Electrical Code, NFPA 70. This publication is available from The National Fire Protection Association, 1 Batterymarch Park, Quincy, MA 02269.

CAUTION

Do NOT test electrical system before heater is filled with water. Follow the *Start-up* procedure in the *Operation* section of this manual.

The principle components of the heater are identified in the *Features and Components* illustration on pages 6 and 7.

⚠ DANGER

Water temperature over 125°F (52°C) can cause severe burns instantly resulting in severe injury or death. Children, the elderly, and the physically or mentally disabled are at highest risk for scald injury. Feel water before bathing or showering. Temperature limiting devices, such as mixing valves, must be installed when required by code and to ensure safe temperatures at fixtures.

Mixing Valve Usage

Water heaters are intended to produce hot water. Water heated to a temperature which will satisfy clothes washing, dish washing, cleaning, and other sanitizing needs can scald and permanently injure you upon contact. Some people are more likely to be permanently injured by hot water than others. These include the elderly, children, the infirm, or the physically or developmentally disabled. If anyone using hot water in your home fits into one of these groups, or if there is a local code or state law requiring a maximum water temperature at the hot water tap, then you must take special precautions. In addition to using the lowest possible temperature setting that satisfies your hot water needs, a means such as a mixing valve, should be used at the hot water taps or at the water heater.

Mixing valves for reducing point-of-use temperature are available. Consult a qualified installer or service agency. Follow all manufacturer's instructions for installation of mixing valves. Before changing the factory setting on the thermostat, read the *Temperature Regulation* section in this manual.

⚠ WARNING

Toxic chemical hazard: Do not connect to non-potable water system.

Chemical Vapor Corrosion

This water heater shall not be connected to any heating system(s) or component(s) used with a non-potable water heating appliance. Toxic chemicals, such as those used for boiler treatment, shall not be introduced into this system. Water heater corrosion and component failure can be caused by the heating and breakdown of airborne chemical vapors. Spray can propellants, cleaning solvents, refrigerator and air conditioning refrigerants, swimming pool chemicals, water softener chemicals, calcium and sodium chloride, waxes, and process chemicals are typical

compounds which are potentially corrosive. These materials are corrosive at very low concentration levels with little or no odor to reveal their presence. Products of this sort should not be stored near the heater. Also, air which is brought in contact with the water heater should not contain any of these chemicals. If necessary, uncontaminated air should be obtained from remote or outside sources.

Insulation Blankets

Insulation blankets are available to the general public for external use on electric water heaters, but are not necessary with this product. The purpose of an insulation blanket is to reduce the standby heat loss encountered with storage tank heaters. Your water heater meets or exceeds the EPACT and ASHRAE/IES 90.1 standards with respect to insulation and standby loss requirements, making an insulation blanket unnecessary.

Should you choose to apply an insulation blanket to this heater, you should follow the instructions below. Failure to follow these instructions can result in fire, serious personal injury, or death.

- Do NOT cover the temperature and pressure relief (T & P) valve with an insulation blanket.
- Do NOT cover the instruction manual. Keep it on the side of the water heater or nearby for future reference.
- DO obtain new warning and instruction labels for placement on the blanket directly over the existing labels.

Temperature - Pressure Relief Valve

⚠ WARNING

The temperature and pressure relief valve must comply with ANSI Z21.22 and ASME code. A properly sized temperature and pressure relief valve must be installed in the opening provided. Failure to install a relief valve can result in overheating and excessive tank pressure. Failure to follow these instructions can cause serious injury or death.

This water heater is provided with a properly rated/sized and certified combination temperature-pressure relief valve by the manufacturer. The valve is certified by a nationally recognized testing laboratory that maintains periodic inspection of production of listed equipment of materials as meeting the requirements for Relief Valves for Hot Water Supply Systems, ANSI Z21.22 • CSA 4.4, and the code requirements of ASME.

NOTICE

The water inlet and outlet threaded connections are steel. When connecting the unit to piping made of a different material, use of a dielectric fitting or a dielectric union conforming to ASSE 1079 is recommended to prevent corrosion and potential subsequent water leaks at or near the connection. Dielectric fittings may be required by local plumbing codes.

3 Installation *(continued)*

If replaced, the new valve must meet the requirements of local codes, but not less than a combination temperature and pressure relief valve rated/sized and certified as indicated in the above paragraph. The new valve must be marked with a maximum set pressure not to exceed the marked hydrostatic working pressure of the water heater (150 psi = 1,035 kPa) and a discharge capacity not less than the water heater Btu/hr or KW input rate as shown on the water heater's model rating plate.

For safe operation of the water heater, the temperature and pressure relief valve must not be removed from its designated opening nor plugged. The temperature-pressure relief valve must be installed directly into the fitting of the water heater designed for the relief valve. Install discharge piping so that any discharge will exit only within 6 inches (15.2 cm) above, or external to the structure. Do not pipe the discharge to a crawl space. Be certain that no contact is made with any live electrical part. The discharge opening must not be blocked or reduced in size under any circumstances. Excessive length, over 30 feet (9.14 m), or use of more than four elbows can cause restriction and reduce the discharge capacity of the valve.

No valve or other obstruction is to be placed between the relief valve and the tank. Do NOT connect discharge piping directly to the drain unless a 6" (15.2 cm) air gap is provided. To prevent bodily injury, hazard to life, or property damage, the relief valve must be allowed to discharge water in adequate quantities, should circumstances demand. If the discharge pipe is not connected to a drain or other suitable means, the water flow may cause property damage.

The discharge pipe:

- Shall NOT be smaller in size than the outlet pipe size of the valve or have any reducing couplings or other restrictions.
- Shall NOT be plugged or blocked.
- Shall NOT be exposed to freezing temperatures.
- Shall be of material listed for hot water distribution.
- Shall be installed in such a way that allows complete drainage of both the temperature-pressure relief valve and the discharge pipe.
- Must terminate a maximum of six inches above a floor drain or external to the building. In cold climates, it is recommended that the discharge pipe be terminated at an adequate drain inside the building.
- Shall NOT have any valve or other obstruction between the relief valve and the drain.

CAUTION

The temperature-pressure relief valve discharge pipe must terminate at adequate drain.

The temperature-pressure relief valve must be manually operated at least once a year. Caution should be taken to ensure that no one is in front of or around the outlet of the temperature-pressure relief valve discharge line, and that the water manually discharged will not cause any bodily injury or property damage because the water may be extremely hot. If after manually operating the valve, it fails to completely reset and continues to release water, immediately close the cold water inlet to the water heater, follow the draining instructions in this manual, and replace the temperature-pressure relief valve with a properly rated/sized new one.

If you do not understand these instructions or have any questions regarding the temperature-pressure relief valve, call the telephone number listed on the back cover of this manual for technical assistance.

DANGER

Water temperature over 125°F (52°C) can cause severe burns instantly resulting in severe injury or death. Children, the elderly, and the physically or mentally disabled are at highest risk for scald injury. Feel water before bathing or showering. Temperature limiting devices, such as mixing valves, must be installed when required by code and to ensure safe temperatures at fixtures. Read instruction manual for safe temperature setting.

Closed Water Systems

Water supply systems may, because of code requirements or such conditions as high line pressure, among others, have installed devices such as pressure reducing valves, check valves, and back flow preventers. Devices such as these cause the water system to be a closed system.

Thermal Expansion

As water is heated, it expands (thermal expansion). In a closed system, the volume of water will grow when it is heated. As the volume of water grows, there will be a corresponding increase in water pressure due to thermal expansion. Thermal expansion can cause premature tank failure (leakage). This type of failure is not covered under the limited warranty. Thermal expansion can also cause intermittent temperature-pressure relief valve operation, water discharged from the valve due to excessive pressure build-up. This condition is not covered under the limited warranty. The temperature-pressure relief valve is not intended for the constant relief of thermal expansion.

A properly sized thermal expansion tank must be installed on all closed systems to control the harmful effects of thermal expansion. Contact a local plumbing service agency to have a thermal expansion tank installed.

4 Electrical

General

Check the water heater model and rating plate information against the characteristics of the branch circuit electrical supply. Do NOT connect the heater to an improper source of electricity.

Voltage applied to the heater should not vary more than +5% to -10% of the model and rating plate marking for satisfactory operation.

The factory wiring is attached to a terminal block on the unit. The branch circuit is connected to the block through an opening provided on the heater. The factory terminal block has 500 MCM maximum copper wire size capacity in each opening. If apparent field wire size is over 500 MCM, multiple terminal blocks will be furnished. If other opening sizes are desired, they should be specified when the unit is ordered.

The installation must conform with these instructions and the local code authority having jurisdiction and the requirements of the power company. In the absence of local codes, the installation must comply with the current editions of the National Electrical Code, NFPA 70, or the Canadian Electrical Code CSA C22.1.

Branch Circuit

The branch circuit wire size should be established through reference to the NEC (National Electrical Code) or other locally approved sources in conjunction with the water heater amperage rating. Wire rated at 75°C should be used. Please see Table 4-1 for additional information. It is suggested that the electrician size the branch circuit at 125% of the heater rating and further increase wire size as necessary to compensate for voltage drop in long runs. Voltage drop should not exceed 3% at the water heater.

Heater Circuits

The water heater's electrical components are pictured and identified by the *Features and Components* illustrations on pages 6 and 7. The model and rating plate illustration identifies the heater electrical characteristics. The heater has two electrical circuits.

- **Control Circuit:** 120V circuit containing all safety and control devices. The control circuit operates the contactors in the power circuit.
- **Power Circuit:** High voltage, single or three-phase circuit that carries the heating element load.

The following section and pages describe the water heater circuits. See pages 38 - 39 for the wiring diagram.

Power Circuit

Power circuit wiring is type THHN (or equivalent) rated 600 volts, 105°C, sized as necessary.

The wiring diagrams at the end of this manual are included to show typical arrangements of electrical components in the control and power circuits by voltage and phase characteristics. They are to be used as a reference by the installer or servicer in performing their work. An actual diagram of the water heater wiring is furnished with the heater.

4 Electrical (continued)

Table 4-1 Amp Chart

Total Ele.				Total AMPS		Main Line Fuse		Field Wire Per Leg	
KW	KW	Qty	Volt	10	30	10	30	10	30
15	15	1	208	73	42	110	60	3	6
			240	63	36	110	50	4	8
			380	**	23	**	30	**	10
			400	**	22	**	30	**	10
			415	**	21	**	30	**	10
			480	**	18	**	25	**	10
600	**	14	**	20	**	12			
18	18	1	208	87	50	110	70	2	4
			240	75	44	110	60	3	6
			380	**	27	**	35	**	8
			400	**	26	**	35	**	8
			415	**	25	**	35	**	8
			480	**	22	**	30	**	10
600	**	17	**	25	**	12			
24	12	2	208	115	67	150	90	0	3
			240	100	58	150	80	0	4
			380	**	36	**	50	**	6
			400	**	35	**	50	**	6
			415	**	33	**	50	**	6
			480	**	29	**	40	**	8
600	**	23	**	30	**	10			
30	15	2	208	145	83	200	110	3/0	2
			240	125	72	175	100	2/0	2
			380	**	46	**	60	**	6
			400	**	43	**	60	**	6
			415	**	42	**	60	**	6
			480	**	36	**	50	**	6
600	**	29	**	40	**	8			
36	18	2	208	174	100	225	150	4/0	0
			240	150	87	200	110	3/0	2
			380	**	55	**	70	**	4
			400	**	52	**	70	**	4
			415	**	50	**	70	**	4
			480	**	43	**	60	**	6
600	**	35	**	45	**	8			
45	15	3	208	217	125	300	175	300	3/0
			240	188	108	250	150	250	2/0
			380	**	68	**	90	**	3
			400	**	65	**	90	**	3
			415	**	63	**	80	**	4
			480	**	54	**	70	**	4
600	**	43	**	60	**	6			
54	18	3	208	260	150	350	200	400	4/0
			240	225	130	300	175	350	3/0
			380	**	82	**	110	**	2
			400	**	78	**	100	**	2
			415	**	75	**	100	**	2
			480	**	65	**	90	**	3
600	**	52	**	70	**	4			
60	15	4	208	289	167	400	225	500	4/0
			240	250	144	350	200	400	4/0
			380	**	91	**	125	**	1
			400	**	87	**	110	**	1
			415	**	83	**	110	**	2
			480	**	72	**	100	**	2
600	**	58	**	80	**	4			
72	18	4	208	**	200	**	250	**	250
			240	**	173	**	225	**	4/0
			380	**	109	**	150	**	0
			400	**	104	**	150	**	0
			415	**	100	**	125	**	1
			480	**	87	**	110	**	2
600	**	69	**	90	**	3			
90	15	6	208	**	250	**	350	**	500
			240	**	217	**	300	**	350
			380	**	137	**	175	**	3/0
			400	**	130	**	175	**	3/0
			415	**	125	**	175	**	3/0
			480	**	108	**	150	**	2/0
600	**	87	**	110	**	2			
108	18	6	208	**	300	**	400	**	(2) 3/0
			240	**	260	**	350	**	500
			380	**	164	**	225	**	4/0
			400	**	156	**	200	**	4/0
			415	**	150	**	200	**	3/0
			480	**	130	**	175	**	2/0
600	**	104	**	150	**	0			
120	15	8	208	**	333	**	450	**	(2) 4/0
			240	**	289	**	400	**	(2) 3/0
			380	**	182	**	250	**	250
			400	**	173	**	225	**	250
			415	**	167	**	225	**	4/0
			480	**	144	**	200	**	3/0
600	**	115	**	150	**	0			
135	15	9	208	**	375	**	500	**	(2) 250
			240	**	325	**	450	**	(2) 4/0
			380	**	205	**	300	**	350
			400	**	195	**	250	**	350
			415	**	188	**	250	**	250
			480	**	162	**	225	**	4/0
600	**	130	**	175	**	2/0			
144	18	8	208	**	400	**	500	**	(2) 250
			240	**	346	**	450	**	(2) 4/0
			380	**	219	**	300	**	350
			400	**	208	**	300	**	300
			415	**	200	**	250	**	250
			480	**	173	**	225	**	4/0
600	**	139	**	175	**	2/0			
162	18	9	208	**	450	**	600	**	(2) 350
			240	**	390	**	500	**	(2) 250
			380	**	246	**	350	**	500
			400	**	234	**	300	**	350
			415	**	225	**	300	**	350
			480	**	195	**	250	**	250
600	**	156	**	200	**	3/0			
180	18	10	208	**	500	**	700	**	(2) 500
			240	**	433	**	600	**	(2) 350
			380	**	273	**	350	**	500
			400	**	260	**	350	**	500
			415	**	250	**	350	**	500
			480	**	217	**	300	**	350
600	**	173	**	225	**	4/0			



4 Electrical

Table 4-1 Amp Chart (continued)

Total Ele.				Total AMPS		Main Line Fuse		Field Wire Per Leg		Total Ele.				Total AMPS		Main Line Fuse		Field Wire Per Leg	
KW	KW	Qty	Volt	10	30	10	30	10	30	KW	KW	Qty	Volt	10	30	10	30	10	30
216	18	12	208	**	600	**	800	**	(3) 300	360	18	20	208	**	999	**	1600	**	(5) 400
			240	**	520	**	700	**	(2) 500				240	**	866	**	1200	**	(4) 350
			380	**	328	**	450	**	(2) 4/0				380	**	547	**	700	**	(2) 500
			400	**	312	**	400	**	(2) 3/0				400	**	520	**	700	**	(2) 500
			415	**	301	**	400	**	(2) 3/0				415	**	501	**	700	**	(2) 500
			480	**	260	**	350	**	500				480	**	433	**	600	**	(2) 350
			600	**	208	**	300	**	350				600	**	346	**	450	**	(2) 4/0
234	18	13	208	**	650	**	1000	**	(2) 400	378	18	21	208	**	1049	**	1600	**	(5) 400
			240	**	563	**	800	**	(2) 300				240	**	909	**	1200	**	(4) 350
			380	**	356	**	500	**	(2) 250				380	**	574	**	800	**	(3) 300
			400	**	338	**	450	**	(2) 4/0				400	**	546	**	700	**	(2) 500
			415	**	326	**	450	**	(2) 4/0				415	**	526	**	700	**	(2) 500
			480	**	281	**	400	**	(2) 3/0				480	**	455	**	600	**	(2) 350
			600	**	225	**	300	**	350				600	**	364	**	500	**	(2) 250
252	18	14	208	**	694	**	1000	**	(3) 400	396	18	22	208	**	1099	**	1600	**	(5) 400
			240	**	606	**	800	**	(3) 300				240	**	953	**	1200	**	(4) 350
			380	**	383	**	500	**	(2) 250				380	**	602	**	800	**	(3) 300
			400	**	364	**	500	**	(2) 4/0				400	**	572	**	800	**	(2) 500
			415	**	351	**	450	**	(2) 4/0				415	**	551	**	700	**	(2) 500
			480	**	303	**	400	**	(2) 3/0				480	**	476	**	600	**	(2) 350
			600	**	242	**	350	**	500				600	**	381	**	500	**	(2) 250
270	18	15	208	**	749	**	1000	**	(3) 400	414	18	23	208	**	1149	**	1600	**	(5) 400
			240	**	650	**	1000	**	(3) 400				240	**	996	**	1600	**	(5) 400
			380	**	410	**	600	**	(2) 350				380	**	629	**	800	**	(3) 300
			400	**	390	**	500	**	(2) 250				400	**	598	**	800	**	(3) 300
			415	**	376	**	500	**	(2) 250				415	**	576	**	800	**	(3) 300
			480	**	325	**	450	**	(2) 4/0				480	**	498	**	700	**	(2) 500
			600	**	260	**	350	**	500				600	**	398	**	500	**	(2) 250
288	18	16	208	**	799	**	1000	**	(3) 400	432	18	24	208	**	1199	**	1600	**	(5) 400
			240	**	693	**	1000	**	(3) 400				240	**	1039	**	1600	**	(5) 400
			380	**	438	**	600	**	(2) 350				380	**	656	**	1000	**	(3) 400
			400	**	416	**	600	**	(2) 350				400	**	624	**	800	**	(3) 300
			415	**	401	**	600	**	(2) 350				415	**	601	**	800	**	(3) 300
			480	**	346	**	450	**	(2) 4/0				480	**	520	**	700	**	(2) 500
			600	**	277	**	350	**	500				600	**	416	**	600	**	(2) 350
306	18	17	208	**	849	**	1200	**	(4) 350	*CONSULT FACTORY FOR 432 KW AND HIGHER.									
			240	**	736	**	1000	**	(3) 400										
			380	**	465	**	600	**	(2) 350										
			400	**	442	**	600	**	(2) 350										
			415	**	426	**	600	**	(2) 350										
			480	**	368	**	500	**	(2) 250										
			600	**	294	**	400	**	(2) 3/0										
324	18	18	208	**	899	**	1200	**	(4) 350	*CONSULT FACTORY FOR 432 KW AND HIGHER.									
			240	**	779	**	1000	**	(3) 400										
			380	**	492	**	700	**	(2) 500										
			400	**	468	**	600	**	(2) 350										
			415	**	451	**	600	**	(2) 350										
			480	**	390	**	500	**	(2) 250										
			600	**	312	**	400	**	(2) 3/0										
342	18	19	208	**	949	**	1200	**	(4) 350	*CONSULT FACTORY FOR 432 KW AND HIGHER.									
			240	**	823	**	1200	**	(4) 350										
			380	**	520	**	700	**	(2) 500										
			400	**	494	**	700	**	(2) 350										
			415	**	476	**	600	**	(2) 350										
			480	**	411	**	600	**	(2) 350										
			600	**	329	**	450	**	(2) 4/2										

4 Electrical *(continued)*

Table 4-2_Electrical and Recoveries Data

Standard KW Ratings	KW of Element	Maximum Number of Elements	Number of Elements per Bank	Number of Banks	Number of Control Boards	BTU Input	GPH Recovery	Number of Contactors		
								208V/240V 1Ø	208V/240V 3Ø	480V/600V 3Ø
15	15	1	1	1	1	51,180	61	1	1	1
18	18	1	1	1	1	61,416	74	2	2	1
24	12	2	1	2	1	81,888	98	2	2	2
30	15	2	1	2	1	102,360	123	2	2	2
36	12	3	1	3	1	122,832	147	3	3	3
36	18	2	1	2	1	122,832	147	4	4	2
45	15	3	1	3	1	153,540	184	3	3	3
48	12	4	1	4	1	163,776	197	4	4	4
54	18	3	1	3	1	184,248	221	6	6	3
60	12	5	1	5	1	204,720	246	5	5	5
60	15	4	1	4	1	204,720	246	4	4	4
72	12	6	2	3	1	245,664	295		6	6
72	18	4	1	4	1	245,664	295		8	4
75	15	5	5	1	1	255,900	307		5	5
90	15	6	2	3	1	307,080	369		6	3
90	18	5	1	5	1	307,080	369		10	5
96	12	8	2	4	1	327,552	393		8	4
108	12	9	3	3	1	368,496	442		9	6
108	18	6	2	3	1	368,496	442		12	6
120	12	10	2	5	1	409,440	492		10	5
120	15	8	2	4	1	409,440	492		8	8
135	15	9	3	3	1	460,620	553		9	6
144	18	8	2	4	1	491,328	590		16	8
150	15	10	2	5	1	511,800	614		10	5
162	18	9	3	3	1	552,744	664		18	9
180	12	15	3	5	1	614,160	737		15	10
180	15	12	3	4	1	614,160	737		12	12
180	18	10	2	5	1	614,160	737		20	10
192	12	16	2	8	2	655,104	786		16	8
210	15	14	2	7	2	716,520	860		14	14
216	12	18	3	6	2	736,992	885		18	9
216	18	12	3	4	1	736,992	885		24	8
225	15	15	3	5	1	767,700	922		15	10
240	12	20	2	10	3	818,880	983		20	10
240	15	16	2	8	2	818,880	983		16	16
252	18	14	2	7	2	859,824	1,032		28	14
270	15	18	3	6	2	921,240	1,106		18	12
270	18	15	3	5	1	921,240	1,106		30	10
288	12	24	3	8	2	982,656	1,180		24	12
288	18	16	2	8	2	982,656	1,180		32	16
300	15	20	2	10	3	1,023,600	1,229		20	20



4 Electrical

Table 4-2_Electrical and Recoveries Data (continued)

Standard KW Ratings	KW of Element	Maximum Number of Elements	Number of Elements per Bank	Number of Banks	Number of Control Boards	BTU Input	GPH Recovery	Number of Contactors		
								208V/240V 1Ø	208V/240V 3Ø	480V/600V 3Ø
315	15	21	3	7	2	1,074,780	1,290		21	14
324	12	27	3	9	2	1,105,488	1,327		27	18
324	18	18	3	6	2	1,105,488	1,327		36	12
360	15	24	3	8	2	1,228,320	1,475		24	16
360	18	20	2	10	3	1,228,320	1,475		40	20
378	18	21	3	7	2	1,289,736	1,548		42	21
390	15	26	2	13	3	1,330,680	1,597		26	26
396	18	22	2	11	3	1,351,152	1,622		44	22
405	15	27	3	9	2	1,381,860	1,659		27	18
420	15	28	2	14	3	1,433,040	1,720		28	28
432	18	24	3	8	2	1,473,984	1,769		48	16



5 Operation

General

Refer to the *Features and Components* section of this manual for the location of components mentioned in the instructions that follow.

NEVER operate the heating elements without being certain the water heater is filled with water and a temperature and pressure relief valve is installed in the relief valve opening on top of the heater.

A low water cutoff is provided on all heaters as standard equipment. The water probe is installed near the top of the tank to monitor the presence of water. The control circuit is opened if the water level is below this point.

The pilot switch (power on/off toggle switch) on the cabinet front permits the heater to be turned on and off without having to operate the electrical disconnect switch.

⚠ DANGER Full power is present whenever the cabinet door is opened, even with the pilot switch turned off.

Optional manual override switches on the cabinet front allow elements to be manually de-energized if full capacity is not needed.

Filling the Water Heater

CAUTION In order to avoid heating element damage, fill the tank with water before operating.

To fill the water heater with water:

1. Turn OFF the electrical disconnect switch.
2. Turn OFF the ON/OFF switch.
3. Close the heater drain valve.
4. Open a nearby hot water faucet to allow the air in the system to escape.
5. Fully open the cold water inlet valve, filling the heater and piping.
6. Close the hot water faucet when the water starts to flow from the faucet. Leave the cold water inlet valve fully open. The heater is now ready for start-up and temperature regulation.
7. Close the cabinet door and perform the start-up checks listed below before turning on the electricity.

Initial Start-up

The following checks should be made by the installer when the water heater is placed into operation for the first time:

1. Check all factory and field-made water and electrical connections for tightness. Also check connections on top of the heater. Repair water leaks and tighten electrical connections as necessary.
2. Turn on the electrical disconnect switch and pilot toggle switch. The pilot toggle switch is located on the cabinet.
3. Observe the operation of the electrical components during the first heating cycle. Exercise care as the electrical circuits are energized.

Temperature control and contactor operation should be checked by allowing the heater to come up to temperature and shut off automatically. Exercise care as the electrical circuits are energized.

Draining the Water Heater

The water heater must be drained if it is to be shut down and/or exposed to freezing temperatures. Maintenance and service procedures may also require draining the heater.

1. Turn OFF the electrical disconnect switch.
2. Turn OFF the ON/OFF switch.
3. Close the cold water inlet valve to heater.
4. Open a nearby hot water faucet to vent the system.
5. Open the drain valve.
6. If the heater is being drained for an extended shutdown, it is suggested that the drain valve be left open during this period.

Follow *Filling the water heater* instructions when restoring hot water service. See the list above.

⚠ DANGER Burn hazard. Keep clear of drain valve discharge outlet.

6 Temperature Regulation

High Temperature Limit Controls (ECO)

If a dry bulb style high limit is used in place of a surface mount in the limit, it should not be set above 190°F/88°C.

When the high limit switch contacts open, the electronic control system locks out and displays a fault message. Voltage to the contactor coils and heating elements is terminated to prevent further heating operation. Once the water temperature has cooled below this point, press the manual reset button. Then the power supply to the water heater must be turned off and then back on to reset the control system.

⚠ DANGER Water temperature over 125°F (52°C) can cause severe burns instantly resulting in severe injury or death. Children, the elderly, and the physically or mentally disabled are at highest risk for scald injury. Feel water before bathing or showering. Temperature limiting devices such as mixing valves must be installed when required by codes and to ensure safe temperatures at fixtures. Read the instruction manual for safe temperature setting.

Thermostat Controls

The water heaters covered in this instruction manual are equipped with adjustable thermostat controls to control water temperature. Hot water temperatures required for automatic dishwasher and laundry use can cause scald burns resulting in serious personal injury and/or death. The temperature at which injury occurs varies with the person's age and duration of exposure. The slower response time of children, the elderly, or disabled persons increases the hazards to them. Never allow small children to use a hot water tap or draw their own bath water. Never leave a child or disabled person unattended in a bathtub or shower. The water heater should be located in an area where the general public does not have access to set temperatures.

Setting the water heater temperatures at 120°F will reduce the risk of scalds. Some states require settings at specific lower temperatures.

Temperature Adjustment

⚠ DANGER Full power is present whenever the cabinet door is opened, even with the ON/OFF switch turned off.

The water heaters covered in this instruction manual are equipped with an electronic control system. The control system senses temperature from a factory-installed immersion temperature probe. See the *Features and Components* illustrations at the beginning of this manual for location. The Operating Set Point is adjusted to control water temperature. This is an adjustable user setting in the control system's Temperature Menu. This and all control system menus are accessed through the UIM (User Interface Module) located on the front panel of the water heater. (FIG. 6-1).

The operating set point is adjustable from 90°F/42°C to 190°F/88°C. The factory setting is 120°F/49°C. See the *Control System Operation* section of this manual for instructions on how to adjust the Operating Set Point and other user settings.

Set the Operating Set Point at the lowest setting which produces an acceptable hot water supply. This will always give the most energy efficient operation.

Figure 6-1_UIM (User Interface Module)

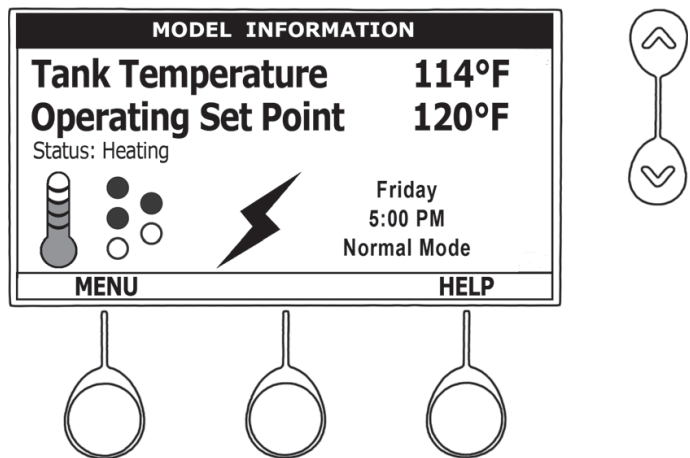

Table 6-1_Approximate time to burn normal adult skin

Water Temperature °F	Time for 1st Degree Burn (Less Severe Burns)	Time for Permanent Burns 2nd & 3rd Degree (Most Severe Burns)
110	(normal shower temp.)	
116	(pain threshold)	
116	35 minutes	45 minutes
122	1 minute	5 minutes
131	5 seconds	25 seconds
140	2 seconds	5 seconds
149	1 second	2 seconds
154	Instantaneous	1 second

(U.S. Government Memorandum, C.P.S.C., Peter L. Armstrong, Sept. 15, 1978)

7 Control System Operation

Heating Banks Operation

Progressive Sequencing: Banks are energized and de-energized according to adjustable (1 to 20°F) differential set points for each bank. The first bank on is rotated with each successive call for heat (bank rotation). The first heating bank energized at the beginning of a heating cycle is the first bank de-energized at the end of the heating cycle (First on/first off). Successive heating cycles would progress as follows on a model equipped with three (3) heating bank:

- First heating cycle: Banks come on [1, 2, 3] and cycle off [1, 2, 3]
- Second heating cycle: Banks come on [2, 3, 1] and cycle off [2, 3, 1]
- Third heating cycle: Banks come on [3, 1, 2] and cycle off [3, 1, 2]
- Fourth heating cycle: Pattern repeats - same as first heating cycle

Control System Features

Advanced Diagnostics

Plain English text and animated icons display detailed operational and diagnostic information. The LCD screen on the front of the water heater displays the sequence of operation in real time. Fault or alert messages are displayed when operational problems occur. The Advanced Service Menu displays a list of possible causes for current fault and alert conditions to aid in servicing.

Economy Mode Operation

The control system automatically lowers the Operating Set Point by a programmed value during user defined time periods. This helps reduce operating costs during unoccupied or peak demand periods.

Control System Navigation

The UIM (User Interface Module) is located on the front cabinet of the water heater. All operational information and user settings are displayed and accessed using the UIM. The UIM includes five (5) snap-acting (momentary) user input buttons; an UP, DOWN, and three (3) operational buttons (FIG 7-1).

Figure 7-1_Control System Navigation

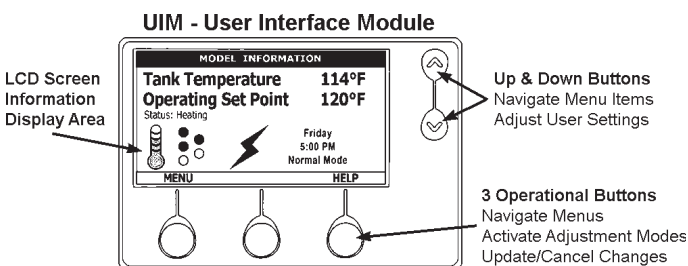

Up & down Buttons

These buttons are used to navigate (up and down) and to select (highlight) menu items. They are also used to adjust or change (increase/decrease, on/off, set time) various user settings.

Operational Buttons

The three (3) operational buttons are multifunctional. Their current function is defined by the text that appears directly above each button on the LCD screen. The function will change depending on what menu is currently displayed or what menu item is selected. When no text appears on the LCD screen above an operational button, there is no function assigned.

The Display Screen

The illustration below shows the control system display screen. This is the default screen. If there are no active fault or alert conditions and no user input for approximately 10 minutes the control system will return to this screen automatically.

- **Model Information:** Model information and menu titles are shown in the black bar at the top of the display screen.
- **Tank Temperature:** Current water temperature as sensed from the immersion temperature probe.
- **Operating Set Point:** Temperature at which the control system will maintain tank (water) temperature in the normal mode. This line of text will read ECONOMY SET POINT whenever the control system is operating in the Economy Mode.
- **Status:** The operating state of the control system is displayed beneath the operating set point.

Figure 7-2_The Display Screen

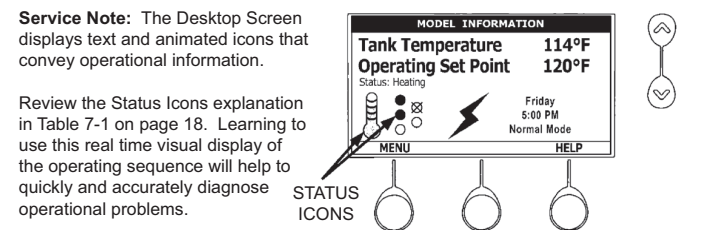

- **Menu:** The left operational button is pressed to enter the main menu where all control system menus are accessed. See Table 7-3 for a list of control system menus.
- **Help:** The right operational button is pressed to access instructions and explanations for user settings, operating states, status icons, manufacturer's web address, technical support phone number, and service agent contact information.



7 Control System Operation

- Day/Time/Operating Mode:** The current time and day are also displayed on the display screen. CLOCK NOT SET will be displayed until the time clock has been initially set. Day and time are adjusted in the Economy Mode Setup Menu. The current operating mode, either Normal Mode or Economy Mode, is displayed beneath the day and time.
- Discreet Menu Contact Information:** From the display screen, press and hold down the middle (unmarked) operational button for 30 seconds, then release it. This will launch a discreet menu where personalized contact information can be entered. Installing contractors and/or service agents can enter their company name and telephone number. This contact information will be displayed with all fault and alert messages.

Table 7-1_Status Icons







ICON	DESCRIPTION
	Water temperature in the tank has fallen. Shaded area of the animated thermometer icon will rise and fall in response to water temperature in the storage tank as sensed from the immersion Temperature Probe.
	Water temperature in the tank has reached the Operating Set Point. Shaded area of the animated thermometer icon will rise and fall in response to water temperature in the storage tank as sensed from the immersion Temperature Probe.
	The control is unable to initiate a heating cycle. This will happen whenever a Fault condition is detected by the control system or when either of the two Enable/Disable circuits are open circuits.
	The control system is in Heating Mode and has energized the electromagnetic contactor coils for at least one heating bank. This animated icon DOES NOT indicate current has been sensed from the heating banks, only that there is a call for heat present and the control system has initiated heating bank operation.
	The control has detected/declared a Fault Condition. Fault message details can be viewed in the Current Fault menu. Heating operation is discontinued (locked out) until the condition that caused the fault is corrected. Power to the water heater must be cycled off and on to reset the control system. Note; cycling power will not reset the control system if the condition that caused the fault has not been corrected.
	The control has detected/declared an Alert Condition. The water heater will continue to operate during an Alert Condition but there is an operational condition that requires the attention of a Qualified Service Agent. Alert message details can be viewed in the Current Alert menu.

Table 7-2_Operating States

STATE	DESCRIPTION
Standby	The water heater is not in an active heating cycle. This usually indicates the temperature in the tank has reached the Operating Set Point and the control system has terminated the heating cycle.
Heating	The control system is in the Heating Mode. At least one heating bank has been energized.
Alert	The control system has detected/declared an Alert Condition. The controls system will continue heating operation. However, a Qualified Service Agent should be contacted to check/service the water heater.
Fault	The control system has detected/declared a Fault Condition. The control system will discontinue heating operation and "lock out." Power to the water heater must be cycled off and on to reset the control system. Note; cycling power will not reset the control system until the condition that caused the fault has been corrected.

7 Control System Operation *(continued)*

Table 7-3_Control System Menus

MENUS	DESCRIPTION
Temperatures	Operating Set Point, Differential settings, Tank Temperature and Tank Probe Offset are located in this menu.
Heater Status	Current Operating State/Mode (heating/standby etc) and status (open/closed - on/off - yes/no) of monitored water heater functions and components are displayed in this menu.
Economy Mode Setup	Seven day 24 hour time clock with temperature set back capability to reduce operating costs during unoccupied or reduced demand periods.
Alarm Output Setup	The control system's CCB (Central Control Board - see wiring diagram) features on board SPDT (single pole double throw) relay contacts for building EMS (Energy Management System) notification of operational conditions such as Fault Conditions and heating mode status. This menu features a list of user definable conditions for relay activation.
Display Settings	Temperature units (°F or °C), appearance (brightness contrast) and backlight delay user adjustable settings are located in this menu.
Heater Information	Elapsed time of operation, total heating cycle time, heating cycle count, heating bank(s) cycle count and on time along with UIM and CCB software revisions can be viewed in this menu.
Current Fault/Alert	Displays any current Alert or Fault messages.
Fault History	Retains 9 event history of Fault/Alert messages with time stamp. The Fault History is useful when dealing with intermittent operational problems or when the customer has reset the control system prior to a service agent's arrival.
Fault Occurrence	Total accumulated number each individual Fault condition has occurred is displayed in this menu. This running total of Fault Occurrences can be useful in determining which (if any) operational problems have been persistent.
Restore Factory Defaults	This control system feature allows the user to restore control system user settings to their factory default settings. Alarm Output Setup and Display Settings menu items ARE NOT changed when factory defaults are restored.
Help Menu	Accessible by pressing the corresponding Operational Button from most menus and screen displays. This menu provides access to instructions and explanations for user settings, Operating States, Status Icons, manufacturer's web address, technical support phone number and service agent contact information.

7 Control System Operation

Temperatures Menu

Operating Set Point

User adjustable setting 90°F to 190°F range; factory default is 120°F. When the water temperature sensed by the control system from the immersion temperature probe reaches the operating set point the control system will end the heating cycle. A call for heat will be activated again when the water temperature drops below the operating set point minus the first differential setting.

Example: Operating set point is 120°F, the first differential setting is 2°F (factory default). A call for heat will be activated when the sensed water temperature drops to 118°F.

Figure 7-3_ Operating Set Point

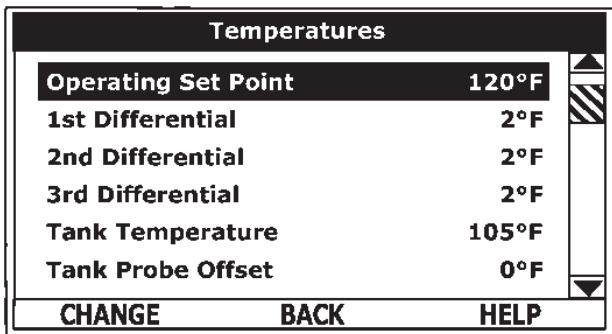

Differential Settings

Adjustable user setting(s) 1°F to 20°F range; factory default is 2°F. The water heaters covered in this manual will have between one (1) and five (5) heating banks per control board. There is at least one differential setting on all models. There will be additional differential settings for each additional heating bank installed.

Operating Sequence Example

On a water heater equipped with three (3) heating banks, with an operating set point of 120°F, and all differential settings at 2°F, the on/off sequencing of heating banks would be as follows in Table 7-4.

Table 7-4_ Sequencing of Heating Banks

BANK NUMBER	DIFFERENTIAL SETTING	TURN ON TEMP	TURN OFF TEMP
Bank 1	2°F	118°F	120°F
Bank 2	2°F	116°F	118°F
Bank 3	2°F	114°F	116°F

Tank Temperature

Non-adjustable information display. Current water temperature as sensed by the control system from the immersion temperature probe.

Tank Probe Offset

User adjustable setting -5°F to +5°F range; factory default is 0°F. If the current tank temperature is sensed from the immersion temperature probe at 120°F and the offset is adjusted to -5°F, the control system would calibrate, or offset, the tank temperature to 115°F. Heating cycles would then start and stop based on the calibrated tank temperature.

Used to calibrate for slight differences in control system temperature sensing. This can improve the precision of temperature control in the storage tank and at points of use. This feature can also be used to compensate for building recirculation loops (hot water returning to the storage tank) that may cause the heating cycle to terminate prematurely.

Temperature Settings

The Operating Set Point and the Differential Settings are adjusted in the Temperatures Menu. The following instructions, on page 25, explain how to adjust these user settings and navigate the control system menus.



7 Control System Operation *(continued)*

Table 7-5_Temperature Screens

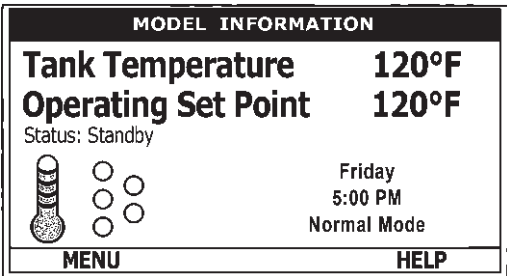
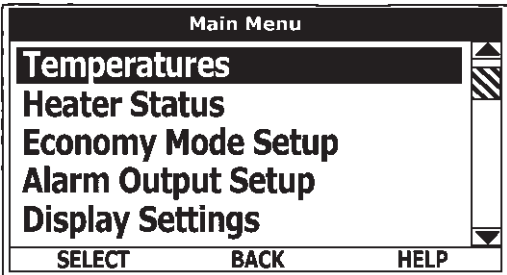
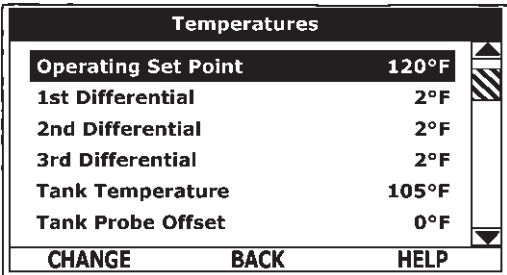
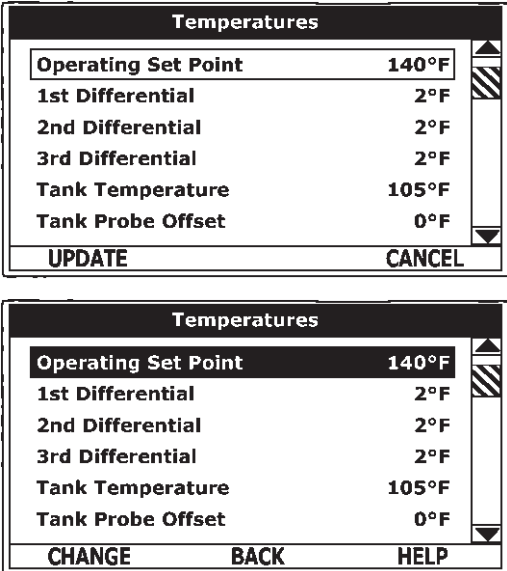
ACTION	DISPLAY
<p>From the Desktop Screen, press the Operational Button underneath "MENU" to enter the Main Menu.</p> <p>Notice how the text above the Operational Buttons on the display changes as you navigate through the various menus and screens.</p>	
<p>With Temperatures selected (highlight in black) in the Main Menu, press the Operational Button underneath "SELECT" to enter the Temperature Menu.</p> <p>If Temperatures is not selected use the Up and Down buttons to select this menu item.</p>	
<p>With the Operating Set Point selected (highlighted in black) in the Temperatures Menu, press the Operational Button underneath "CHANGE" to activate the adjustment mode for this menu item.</p>	
<p>Press the Up and Down buttons to adjust the Operating Set Point to the desired setting.</p> <p>Press the Operational Button underneath "UPDATE" to confirm the new setting. Press the Operational Button underneath "CANCEL" to discard the new setting and retain the previous setting.</p> <p>The new Operating Set Point value should now be displayed as the current value.</p> <p>NOTE: Use this same procedure to adjust the Differential settings and the Tank Probe Offset in the Temperatures Menu.</p> <p>This same procedure is used to change user settings in other control system menus.</p>	



7 Control System Operation

Water Heater Status Menu

This menu displays non-adjustable operational information. Use the up and down buttons to navigate to the bottom of this menu.

Figure 7-4_ Status Menu Screens

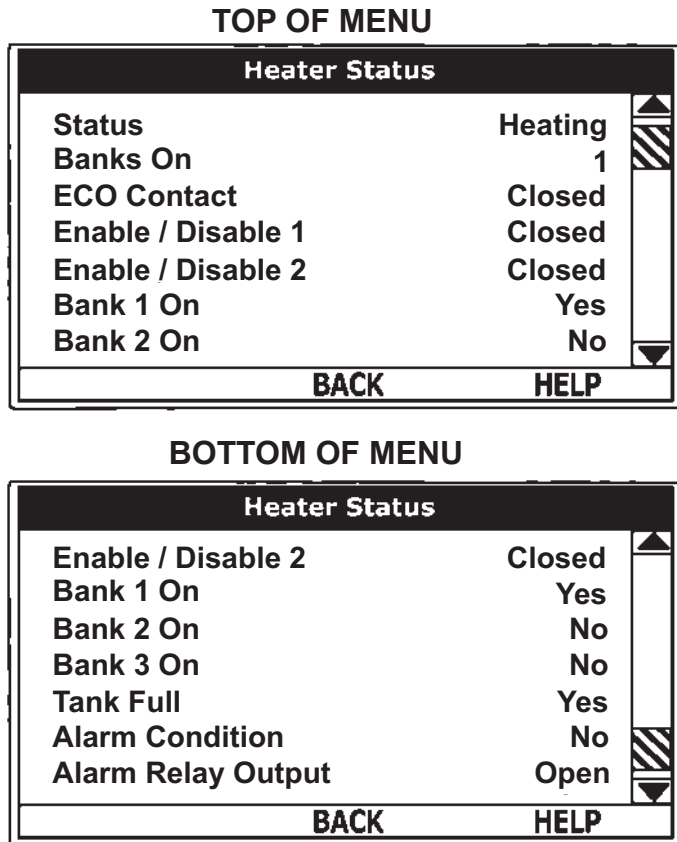

Status

Displays the current operating state of the control system, such as heating, standby, and fault.

Banks On

Displays the number of heating elements the control system has energized.

ECO Contact

Displays the current state of the ECO high temperature limit switch contacts.

Enable / Disable 1 & 2

Displays the current state, open or closed, of the two enable/disable circuits (J7 socket on the CCB - see wiring diagrams) provided for external supervisory controls such as building EMS (Energy Management System). Both of these enable/disable circuits must be closed to enable heating operation. If either enable/disable circuit is open for any reason, heating operation will be disabled. There is a plug with two jumper wires installed from the factory in the CCB J7 socket to enable heating operation when external controls are not in use.

NOTE: If a supervisory control is used to enable or disable heating operation, install field wiring between the J7 socket on the CCB and a set of dry contacts on the external control per all applicable building codes. This is a switching circuit only. DO NOT apply any external voltage or connect any load (i.e., relay coil) to either circuit.

Element # On

Displays the on/off status of each heating bank. Yes = On, No = Off.

Tank Full

Displays the status of the LWCO (Low Water Cut Off) device. Yes = water level is acceptable, No = water level is low.

Alarm Condition

Displays the status of the user definable alarm output function - see alarm output setup menu. Yes = alarm condition has been met, No = alarm condition has not been met.

Alarm Relay Output

Displays the state of the normally open contacts of the alarm output relay. This relay (J3 contacts on the CCB - see wiring diagrams) is used for building EMS (Energy Management System) notification of operational conditions such as fault conditions.

7 Control System Operation *(continued)*

Economy Mode Setup Menu

This menu contains settings used to establish an economy set point and economy mode operating periods, or night setback. This control system feature can help reduce operating costs during unoccupied, low load, or peak demand periods.

Figure 7-5_Economy Mode Screens

DISPLAY SCREEN DURING ECONOMY MODE

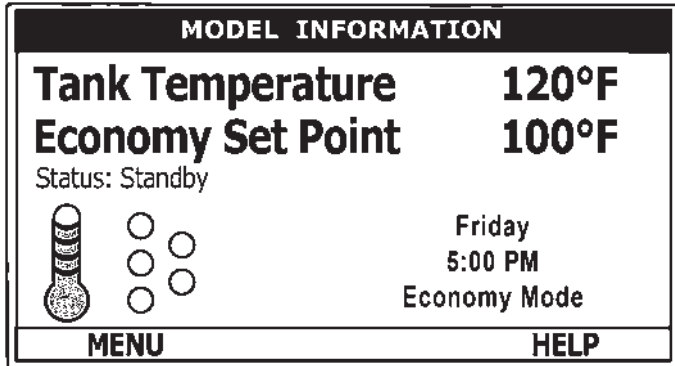

ECONOMY MODE SETUP MENU

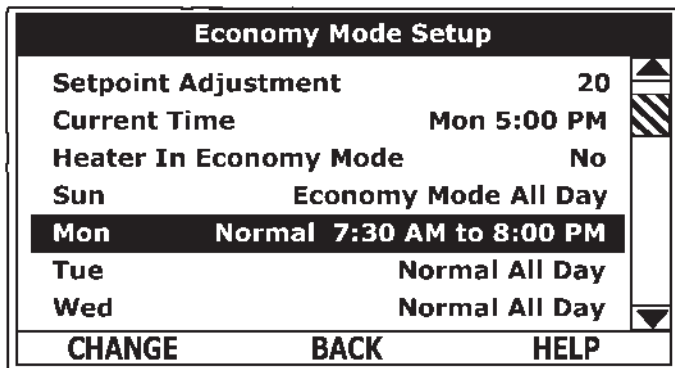

Set Point Adjustment

Adjustable user setting (2°F to 50°F - factory default is 20°F) the control system uses to calculate the Economy Set Point. The Economy Set Point is the normal operating set point minus the programmed set point adjustment value.

The Economy Set Point is the water temperature that the control system maintains during programmed economy mode time periods. ECONOMY SET POINT is displayed instead of OPERATING SET POINT, and ECONOMY MODE appears beneath the current time on the display screen during economy mode time periods.

Current Time

Seven Day 24 hr clock. Use this menu item to set the current time and day of the week. Current day and time are not set from the factory. CLOCK NOT SET will be displayed on the display until the time/day has been initially set. **NOTE:** The time will not self adjust for Daylight Savings Time.

Daily Operating Mode (Sun - Mon - Tue - Wed - Thu - Fri - Sat)

Seven daily sub menus are listed at the bottom of the Economy Mode Setup menu. There are 3 Operating Modes in each sub menu. *Normal Operation All Day*, *Economy Mode All Day*, and *Normal Operation Between*. Only one Operating Mode can be active. The factory default is *Normal Operation All Day*.

Normal Operation All Day: When this operating mode is active, the normal Operating Set Point is used for the entire day.

Economy Mode All Day: When this operating mode is active the Economy Set Point is used for the entire day.

Normal Operation Between: When this operating mode is active, there will also be start and stop times to program. The normal Operating Set Point is used between the programmed start and stop times, and the Economy Set Point will be in effect during the rest of the day. There is one start time and one stop time event per day.



7 Control System Operation

Table 7-6 Economy Mode Settings - Setpoint Adjustment Value

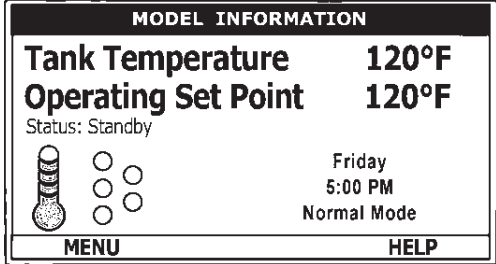
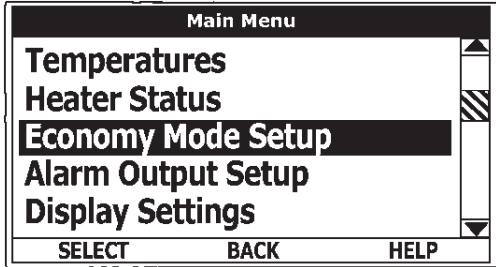
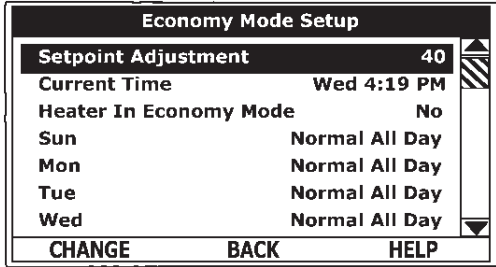
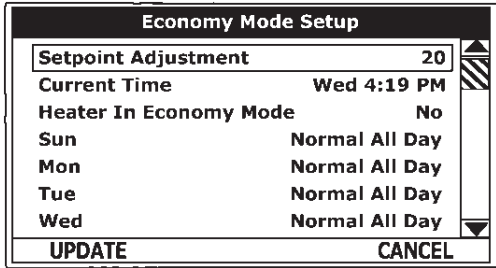
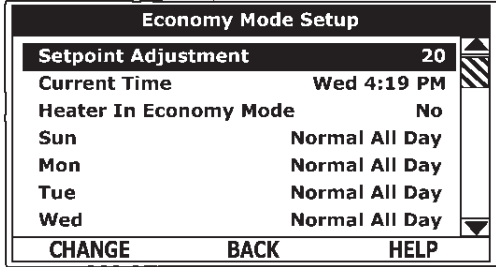
ACTION	DISPLAY
<p>From the Display Screen, press the Operational Button underneath "MENU" to enter the Main Menu.</p> <p>Notice how the text above the Operational Buttons on the display changes as you navigate through the various menus and screens.</p>	
<p>Use the Up/Down buttons to select (highlight in black) the Economy Mode Setup menu from the Main Menu. Press the Operational Button underneath "SELECT" to enter the Economy Mode Setup menu.</p>	
<p>Use the Up/Down buttons to select (highlight in black) Setpoint Adjustment. Press the Operational Button underneath "CHANGE" to activate the adjustment mode for the Setpoint Adjustment value.</p>	
<p>Use the Up/Down buttons to change the Setpoint Adjustment to the desired value. The Setpoint Adjustment value is adjustable from 2°F to 50°F. The factory default is 20°F.</p> <p>Notice how the text above the Operational Buttons on the display changes to "UPDATE" & "CANCEL" when the adjustment mode is activated and how the current value is outlined rather than highlighted in black.</p> <p>Press the Operational Button underneath "UPDATE" to enter and confirm the new value. Pressing the Operational Button underneath "CANCEL" would discard the new value and retain the previous value.</p>	
<p>The new Setpoint Adjustment value should now be displayed as the current value.</p>	



7 Control System Operation *(continued)*

Table 7-7_Economy Mode Settings - Time Clock Settings

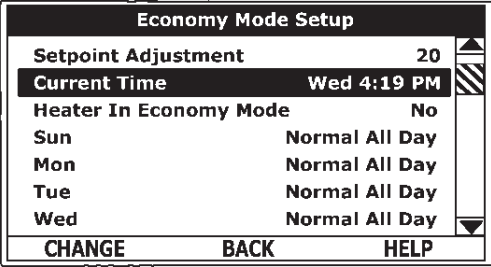
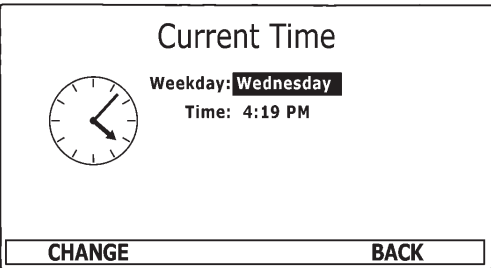
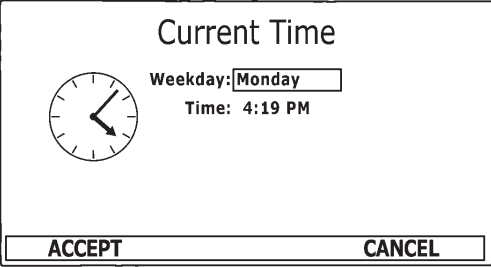
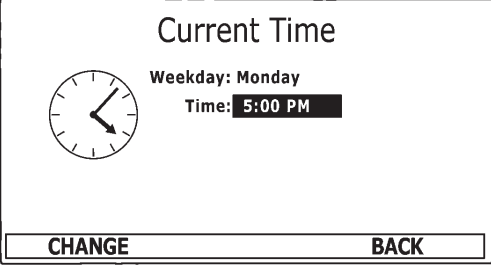
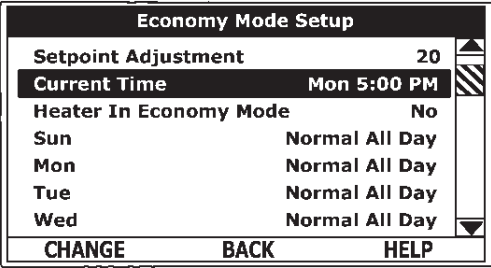
ACTION	DISPLAY
<p>Use the Up/Down buttons to select (highlight in black) Current Time sub menu. Press the Operational Button underneath "CHANGE" to enter the Current Time sub menu.</p>	
<p>Use the Up/Down buttons to select the "Weekday" setting.</p> <p>Press the Operational Button underneath "CHANGE" to activate the adjustment mode for this setting.</p>	
<p>Press the Up/Down buttons to adjust the Weekday setting to the current day.</p> <p>Notice how the text above the Operational Buttons on the display changes to "ACCEPT" & "CANCEL" when the adjustment mode is activated and how the current setting is outlined rather than highlighted in black.</p> <p>Press the Operational Button underneath "ACCEPT" to enter and confirm the new setting. Pressing the Operational Button underneath "CANCEL" would discard the new setting and retain the previous setting.</p>	
<p>Use the Up/Down and the CHANGE/ACCEPT Operational Buttons to individually select and change the remaining time settings (Hour, Minutes, AM/PM) to the current time in the same way as outlined above.</p> <p>When finished making changes press the Operational Button underneath "BACK" to confirm all new settings and update the control system. The display will automatically return to the Economy Mode Setup menu.</p>	
<p>The new settings should be displayed as the Current Time.</p>	



7 Control System Operation

Table 7-8_Economy Mode Settings - Daily Operating Mode Settings

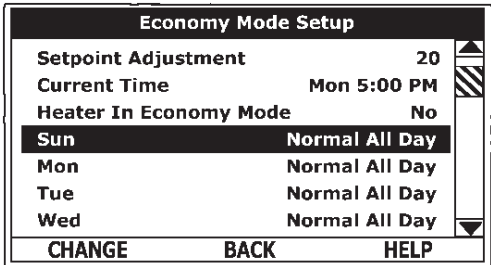
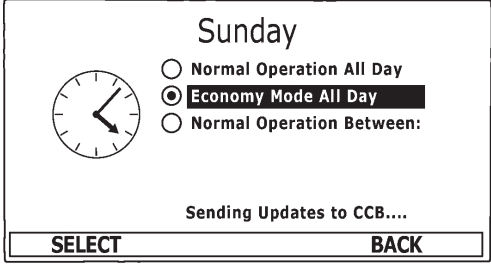
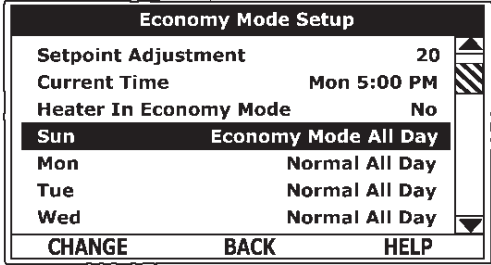
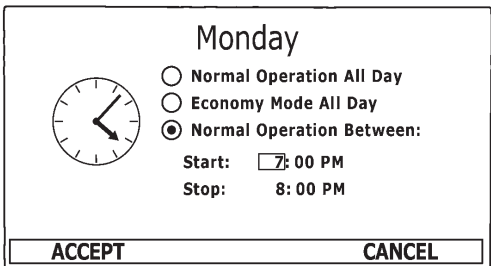
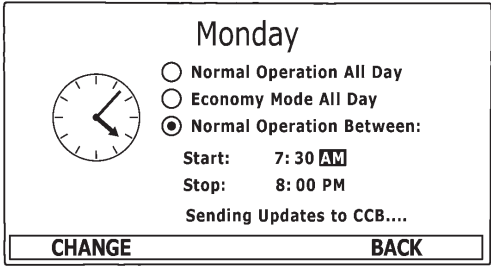
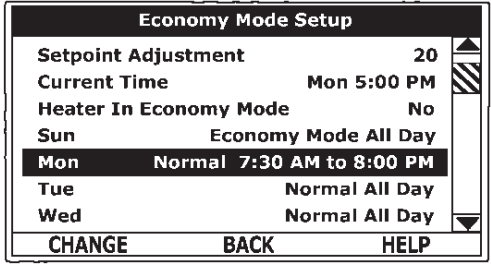
ACTION	DISPLAY
<p>Economy Mode All Day:</p> <p>From the Economy Mode Setup menu use the Up/Down buttons to select (highlight in black) the Daily sub menu for "Sun." Press the Operational Button underneath "CHANGE" to enter this menu.</p>	 <p>Economy Mode Setup</p> <p>Setpoint Adjustment 20</p> <p>Current Time Mon 5:00 PM</p> <p>Heater In Economy Mode No</p> <p>Sun Normal All Day</p> <p>Mon Normal All Day</p> <p>Tue Normal All Day</p> <p>Wed Normal All Day</p> <p>CHANGE BACK HELP</p>
<p>Use the Up/Down buttons to select (highlight in black) the "Economy Mode All Day" setting.</p> <p>Press the Operational Button underneath "SELECT" to change from the factory default Normal Operation All Day setting to the Economy Mode All Day setting.</p> <p>Press the Operational Button underneath "BACK" to confirm the new setting and update the control system. You will be returned to the Economy Mode Setup menu. The new setting should now be displayed for Sun.</p>	 <p>Sunday</p> <p><input type="radio"/> Normal Operation All Day</p> <p><input checked="" type="radio"/> Economy Mode All Day</p> <p><input type="radio"/> Normal Operation Between:</p> <p>Sending Updates to CCB....</p> <p>SELECT BACK</p>  <p>Economy Mode Setup</p> <p>Setpoint Adjustment 20</p> <p>Current Time Mon 5:00 PM</p> <p>Heater In Economy Mode No</p> <p>Sun Economy Mode All Day</p> <p>Mon Normal All Day</p> <p>Tue Normal All Day</p> <p>Wed Normal All Day</p> <p>CHANGE BACK HELP</p>
<p>Normal Operation Between:</p> <p>From the Economy Mode Setup menu Use the Up/Down and CHANGE buttons to enter the Mon sub menu as described above.</p> <p>Use the Up/Down buttons to select (highlight in black) the "Normal Operation Between" setting. Press the Operational Button underneath "SELECT" to change the operating mode for Monday to Normal Operation Between. Note that when this setting is selected Start and Stop time user settings appear on the display.</p> <p>Use the Up/Down buttons to navigate between the Start and Stop time Hour, Minutes and AM/PM settings.</p> <p>With each item selected press the Operational Button underneath "CHANGE" to activate the adjustment mode for each setting. Use the Up/Down buttons to change the value to the desired setting.</p> <p>Press the Operational Button underneath "ACCEPT" to enter the new setting or "CANCEL" to discard the new setting and retain the previous setting.</p> <p>Press the Operational Button underneath "BACK" when finished to confirm the new settings and update the control system. The display will return to the Economy Mode Setup menu with the new settings shown for Mon.</p>	 <p>Monday</p> <p><input type="radio"/> Normal Operation All Day</p> <p><input type="radio"/> Economy Mode All Day</p> <p><input checked="" type="radio"/> Normal Operation Between:</p> <p>Start: 7:00 PM</p> <p>Stop: 8:00 PM</p> <p>ACCEPT CANCEL</p>  <p>Monday</p> <p><input type="radio"/> Normal Operation All Day</p> <p><input type="radio"/> Economy Mode All Day</p> <p><input checked="" type="radio"/> Normal Operation Between:</p> <p>Start: 7:30 AM</p> <p>Stop: 8:00 PM</p> <p>Sending Updates to CCB....</p> <p>CHANGE BACK</p>  <p>Economy Mode Setup</p> <p>Setpoint Adjustment 20</p> <p>Current Time Mon 5:00 PM</p> <p>Heater In Economy Mode No</p> <p>Sun Economy Mode All Day</p> <p>Mon Normal 7:30 AM to 8:00 PM</p> <p>Tue Normal All Day</p> <p>Wed Normal All Day</p> <p>CHANGE BACK HELP</p>

7 Control System Operation *(continued)*

Alarm Output Setup Menu

This menu permits the user to set the condition (from a list of options) for when the CCB's integral alarm output relay will be energized. Alarm relay connections (common, normally open, and normally closed) are located on the J3 terminal strip on the CCB - see wiring diagrams. Alarm output relay contacts are capable of switching 1 amp maximum at 120 VAC.

Figure 7-6 Alarm Output Setup Menu

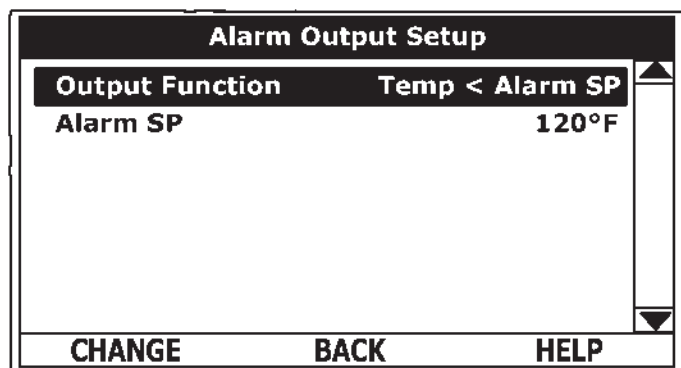
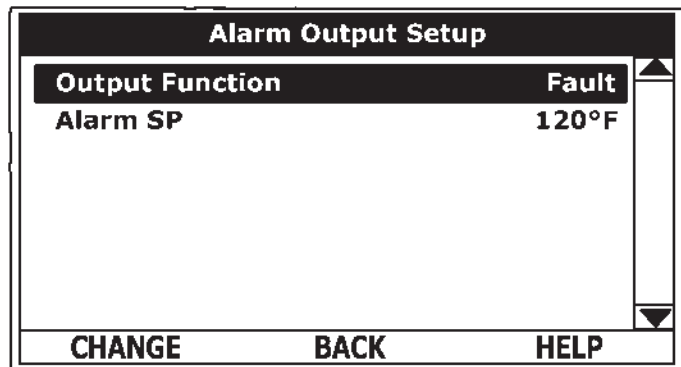

The alarm relay operates in the background according to the settings in this menu, and it is not capable of disabling water heater operation. The alarm relay is used for external notification/verification of various operational conditions such as fault conditions and heating mode status. This relay can be used with Building Management Systems and other external supervisory controls.

Output Function

Adjustable user setting. Available options for the alarm output function setting are:

Heating Mode: Used for heating mode on/off status notification.

Enable / Disable Closed: Used for notification and/or verification of the enable/disable circuits open/closed status. There are two enable/disable circuits available for external supervisory control(s) at the J7 socket on the CCB - see wiring diagrams. Enable/disable circuit(s) status can be viewed in the Heater Status Menu.

Temp < Heater SP: Used for external notification when current tank temperature drops below Operating Set Point.

Temp < Alarm SP: Used for external notification when current tank temperature drops below programmable Alarm SP.

Fault or Alert: Used for external notification whenever a fault or alert condition is active.

Fault: Used for notification whenever a fault condition is active.

Disabled: Disables the Alarm Relay Output function.

Alarm SP

Adjustable user setting (90°F to 190°F) the control system uses for the *Temp < Alarm SP* function described above. This setting has no effect with any other Alarm Output functions.

Alarm Output Settings

Changing the user settings in this menu is done using the same methods for changing the Operating Set Point.

NOTE: Adjustable user settings in the Alarm Output Setup menu are unaffected by Restore Factory Defaults.

Display Settings Menu

This menu permits the user to set display options for viewing information on the UIM's LCD screen.

Figure 7-7 Display Settings Menu

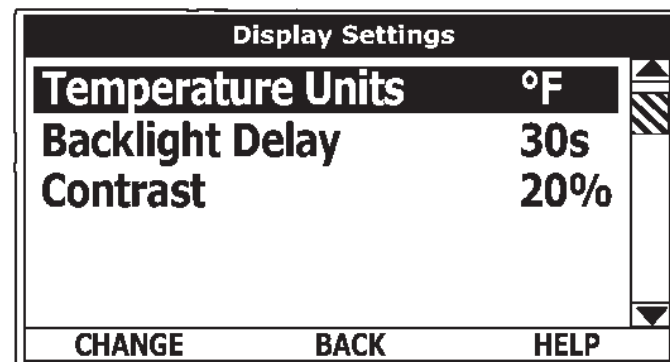

Temperature Units

Adjustable user setting that changes the temperature units display to Celsius °C or Fahrenheit °F.

Backlight Delay

Adjustable user setting that determines how long the UIM's LCD backlight remains illuminated after a key has been pressed. Available settings are: Always Off, 10, 30, or 60 seconds, and Always On.

Contrast

Adjustable user setting to adjust the UIM's LCD screen contrast between text and background.

7 Control System Operation

Display Settings

Changing the user settings in this menu is done using the same methods for changing the Operating Set Point.

NOTE: Adjustable user settings in the Display Settings menu are unaffected by Restore Factory Defaults.

Heater Information Menu

This menu displays non-adjustable operational information.

Figure 7-8_Heater Information Menu

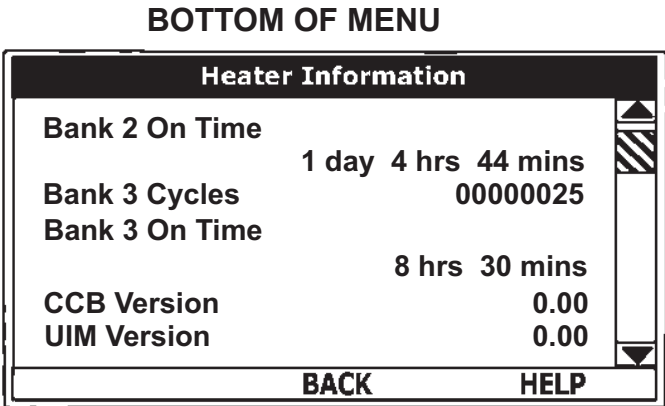
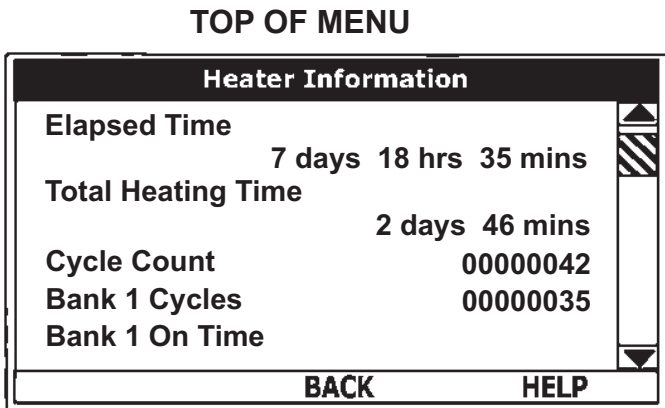

Elapsed Time

Total accumulated time the control system (water heater) has been energized.

Total Heating Time

Total accumulated time the control system has been in the heating mode (i.e., any heating elements have been energized).

Bank # Cycles

Total accumulated count of heating cycles for each heating bank.

Bank # On Time

Total accumulated heating on time for each heating bank.

CCB Version

Software version for Central Control Board.

UIM Version

Software version for User Interface Module.

Current Fault / Alert Menu

This menu displays non-adjustable operation information. With the Fault History sub menu selected in Main Menu, press the Operational button underneath SELECT to display the current fault or alert message. If there is not a fault or alert condition currently active NONE is displayed to the right of this menu.

Figure 7-9_Main Menu - Current Fault Selected

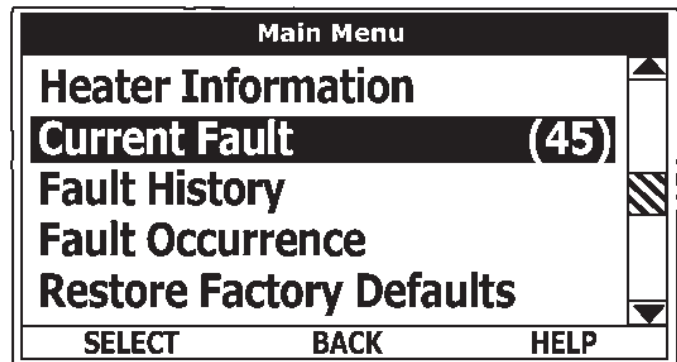

Fault History Menu

This menu displays non-adjustable operational information. The control system records and stores the last nine (9) fault and alert messages in chronological order and displays them in this menu. The most recent message will be at the top of the list. A time stamp is displayed below each listed fault and alert message showing when the fault or alert condition occurred.

The Fault History is useful when dealing with intermittent operation problems or when the customer has reset the control system prior to a service agent's arrival.

With a fault or alert item selected, press the Operational Button underneath VIEW to display the details for the fault or alert message. The Fault/Alert message screen displays a brief description of the condition, contact information, and access to the Advanced Service Information sub menu.

7 Control System Operation *(continued)*

Figure 7-10_Fault History Screens

FAULT HISTORY MENU

Fault History	
1:	No Current Detected (40D) 1 days 5 hrs 45 mins ago
2:	Energy Cut Out (ECO) (A5) 1 days 6 hrs 20 mins ago
3:	Temp Probe Short (45) 2 days 1 hrs 10 mins ago
4:	No Current Detected (40D)
VIEW BACK HELP	

CURRENT / HISTORY FAULT MESSAGE

Temp Probe Short

Fault occurred 14 mins ago

There is a problem with the temperature probe.

Call a service professional:
Paul Stewart
(XXX) XXX - XXXX

(press [DOWN] for more.....)

BACK ADVANCED

Fault Occurrence Menu

This menu displays the total accumulated number of times each individual fault condition has occurred. This running total of fault occurrences can be useful in determining which, if any, operational problems have been persistent.

Figure 7-11_Fault Occurrence Menu

Fault Occurrence	
ECO	1
No Current Detected	3
LWCO	2
Tank Temp Probe	1
Powered Anode Fail	1
CCB Hardware	0
Model Faults	0
BACK HELP	



7 Control System Operation

Restore Factory Defaults Menu

This control system menu allows the user to restore most of the control system's user settings to their factory default settings. User settings in the Alarm Output Setup and Display Settings menus are unaffected by executing Restore Factory Defaults.

Table 7-9 Restore Factory Defaults

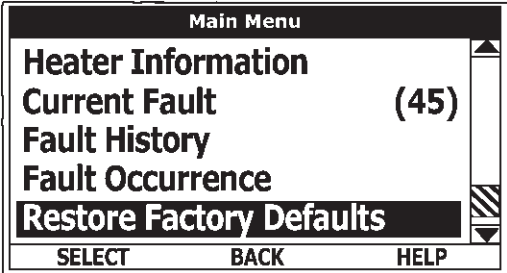
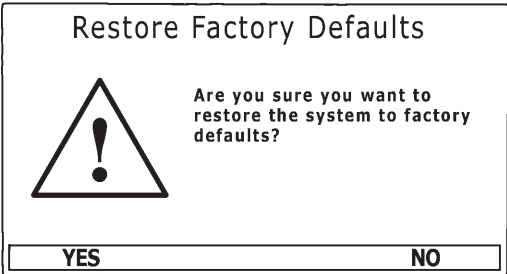
ACTION	DISPLAY
<p>From the Main Menu use the Up/Down buttons to select (highlight in black) the "Restore Factory Defaults" menu.</p> <p>Press the Operational Button underneath "SELECT." The Restore Factory Defaults menu will be displayed.</p>	 <p>The screenshot shows a 'Main Menu' with the following options: 'Heater Information', 'Current Fault (45)', 'Fault History', 'Fault Occurrence', and 'Restore Factory Defaults'. The 'Restore Factory Defaults' option is highlighted with a black background. At the bottom of the screen are three buttons: 'SELECT', 'BACK', and 'HELP'.</p>
<p>From the Restore Factory Defaults menu press the Operational Button underneath "YES." The display will show text confirming the factory default settings have been restored.</p> <p>Press the Operational Button underneath "BACK" to exit the Restore Factory Defaults menu.</p>	 <p>The screenshot shows a confirmation screen titled 'Restore Factory Defaults'. It features a warning triangle icon with an exclamation mark. To the right of the icon, the text reads: 'Are you sure you want to restore the system to factory defaults?'. At the bottom of the screen are two buttons: 'YES' and 'NO'.</p>

8 Maintenance

General

⚠ DANGER

Burn hazard. Keep clear of drain valve discharge outlet.

Periodically, the drain valve should be opened and the water allowed to run until it flows clean. This will help to prevent sediment buildup in the tank bottom.

Periodically check the temperature and pressure relief valve to ensure that it is in operating condition. Lift the lever at the top of the valve several times until the valve seats properly and operates freely.

Water heater maintenance includes periodic tank flushing and cleaning and removal of lime scale from the heating element.

The heater tank is equipped with an anode rod to aid in corrosion control and should be inspected periodically (see *Anode Rod Inspection*).

Anode Rod Inspection

CAUTION

All water heaters eventually leak. Do not install without adequate drainage.

Each water heater contains at least one (1) anode rod, which will slowly deplete, due to electrolysis, prolonging the life of the water heater by protecting the glass-lined tank from corrosion. Adverse water quality, hotter water temperatures, high hot water usage, hydronic heating devices, and water softening methods can increase the rate of anode rod depletion. Once the anode rod is depleted, the tank will start to corrode, eventually developing a leak.

Artificially softened water is exceedingly corrosive because the process substitutes sodium ions for magnesium and calcium ions.

The use of a water softener may decrease the life of the water heater tank.

The anode rod should be inspected after a maximum of three (3) years and annually thereafter until the condition of the anode rod dictates its replacement.

NOTE: Artificially softened water requires the anode rod to be inspected annually.

The following are typical, but not all, signs of a depleted anode rod:

- The majority of the rods diameter is less than 3/8".
- Significant sections of the support wire (approximately 1/3 or more of the anode rod's length) are visible.

If the anode rod shows signs of either or both, it should be replaced. **NOTE:** Whether re-installing or replacing the anode rod, check for any leaks and immediately correct if found.

To replace the anode:

1. Turn OFF electric supply to the water heater.
2. Shut OFF the water supply and open a nearby hot water faucet to depressurize the water tank.
3. Drain the tank. Refer to *Draining and Flushing* for proper procedures. Close the drain valve.
4. Remove the old anode rod.
5. Use Teflon® tape or approved pipe sealant on threads, and install a new anode rod.
6. Turn ON water supply and open a nearby hot water faucet to purge air from the water system. Check for any leaks and immediately correct any if found.
7. Restart the water heater as directed in this manual. See the *Features and Components* illustrations for anode rod location.

Flushing the Water Heater

1. Turn OFF the electrical supply to the water heater at the breaker or disconnect switch.
2. Ensure the cold water inlet valve is open.
3. Open a nearby hot water faucet and let the water run until the water is no longer hot, then close the hot water faucet.
4. Connect a hose to the water heater drain valve and terminate it to an adequate drain.
5. Ensure that the drain hose is secured before and during the entire flushing procedure. Flushing is performed with system water pressure applied to the water heater.
6. Open the water heater drain valve to flush the storage tank.
7. Flush the water heater storage tank to remove sediment and allow the water to flow until it runs clean.
8. Close the water heater drain valve when flushing is completed.
9. Remove the drain hose.
10. Fill the water heater (see the *Filling the Water Heater* section in this manual).
11. Turn ON the electrical supply to the water heater.
12. Place the water heater back in operation. Allow the water heater to complete several heating cycles to ensure it is operating properly.

8 Maintenance

Sediment Removal

Water borne impurities consist of fine particles of soil and sand, which settle out and form a layer of sediment on the bottom of the tank. In time, if not removed, the level of sediment might reach the heating banks and cause their failure.

For convenience, sediment removal and bank lime scale removal should be performed at the same time as follows in this chapter.

Lime Scale Removal

Lime scale accumulations on the heating banks is a normal condition, common to all immersion-type banks. Factors which affect the amounts of this formation are:

1. The amount of hot water used. As the volume of water heated increases, more scale results.
2. Water temperature. As the temperature of the water is increased, more scale is deposited on the banks.
3. Characteristics of water supply.

Regardless of water treatment, it is recommended that the banks be inspected periodically. This can be completed by viewing the element through the cleanout, optional 4"x 6" handhole, 12"x 16" manway, ore removing the element.

Lime scale accumulations may cause noises to occur during operation.

It is recommended that a heating bank be removed periodically for examination. If it is scaled, all of the banks should be removed and cleaned. If the tank bottom has an accumulation of sediment, it should be removed.

Lime scale should be removed by dissolving the accumulation in delimer. Do NOT use muriatic or hydrochloric acid based deliming solutions to remove lime scale from the banks.

The process for lime scale removal is as follows:

1. Turn OFF electrical disconnect switch.
2. Drain the heater following *Draining* instructions.
3. Open front panel.
4. Disconnect the bank wiring. Try not to disturb the wiring unnecessarily and reconnection will be easier.
5. Unscrew each bank.
6. Remove the banks and gaskets from the openings. Use a twisting, pulling action to remove banks scaled beyond the size of the tank openings. Brush loose scale from the banks.
7. Remove lime scale by placing the limed ends of the heating banks into delimer and allow scale to dissolve. Do NOT permit delimer or water to contact the heating bank electrical terminals. Silicates, sulfates, and aluminates must be removed by scraping or other mechanical means. Lime scale dissolvents will not remove these types of scale which are occasionally encountered.

Other Scale Removal:

1. Flush cleaned ends of banks with water when deliming or cleaning is completed.
2. Remove sediment and scale from the tank bottom through the access provided by the bank openings or drain valve opening. The cold water inlet valve and drain valve may be opened to aid the clean-out process.
3. Clean remaining gasket material from the tank and bank flanges. Do NOT reuse original bank gaskets.
4. Put new gaskets on each bank and install into tank openings. Uniformly tighten bank bolts. Torque to approximately 32 ft./lbs.
5. Attach bank wires to the connection points from which they were removed.
6. Follow *Filling* instructions to restore hot water service. Check for water leaks around the banks, and check for proper operation when the heater is filled. Close the front panel.

9 Troubleshooting

Checklist

Before calling for service, check the following points to see if the cause of trouble can be identified and corrected. Reviewing this checklist may eliminate the need of a service call and quickly restore hot water service.

WARNING

Before removing any access panels or servicing the water heater, make sure the electrical supply to the water heater is turned OFF. Failure to do this could result in death, serious bodily injury, or property damage.

Not Enough or No Hot Water

1. Be certain the electrical disconnect switch serving the water heater is in the ON position. The pilot toggle switch on the cabinet should be ON.

In some areas, water heater electrical service may be limited by the power company. If the heater operates on a controlled circuit, heater recovery may be affected.

The optional manual override switches on the cabinet front may be turned off, de-energizing the elements.

2. Check the fuses. The electrical disconnect switch usually contains fuses. The water heater has fuses located behind the cabinet front door (see the *Features and Components* section of this manual for their location).
3. If the water was excessively hot, and is now cold, the ECO high limit switch may have activated. See the *Temperature Regulation* section of this manual for more information on how to reset the ECO high limit controls. Repeated activation of the ECO high limit switch should be investigated by a qualified service agent.
4. The storage capacity and/or recovery rate of the water heater may have been exceeded by a large demand for hot water. Large demands require a recovery period to restore water temperature.
5. Cold incoming water temperature will lengthen the time required to heat water to the desired temperature. If the heater was installed when incoming water temperature was warm, colder water creates the effect of less hot water.
6. Sediment or lime scale may be affecting water heater operation.

Water is Too Hot

Refer to the *Temperature Regulation* section of this manual.

Water Heater Makes Strange Sounds

1. Sediment or lime scale accumulations on the elements causes sizzling and hissing noises when the heater is operating. The sounds are normal, however, the tank bottom and elements should be cleaned. Refer to the *Maintenance* section of this manual for details.
2. Some of the electrical components of the water heater make sounds which are normal (i.e., contactors will “click” or snap as the heater starts and stops).

Leakage Checkpoints

1. Check to see if the drain valve is tightly closed.
2. The apparent leakage may be condensation which forms on cool surfaces of the heater and piping.
3. If the outlet of the relief valve is leaking it may represent excessive water pressure, excessive water temperature, or a faulty temperature and pressure relief valve.

Excessive water pressure is the most common cause of relief valve leakage. Water supply systems may, because of code requirements or such conditions as high line pressure, among others, have installed devices such as pressure reducing valves, check valves, and back flow preventers. Devices such as these cause the water system to be a closed system.

As water is heated, it expands (thermal expansion). In a closed system the volume of water will grow when it is heated. As the volume of water grows, there will be a corresponding increase in water pressure due to thermal expansion. Thermal expansion can cause intermittent temperature-pressure relief valve operation, or water discharged from the valve due to excessive pressure build-up. This condition is not covered under the limited warranty. The temperature-pressure relief valve is not intended for the constant relief of thermal expansion.

A properly sized thermal expansion tank should be installed on all closed systems to control the harmful effects of thermal expansion. Contact a local qualified service agency to have a thermal expansion tank installed.

4. Examine the flange area of the elements for gasket leakage. Tighten the bolts or, if necessary, follow the *Water and Lime Scale Removal* procedure in the *Maintenance* section of this manual to replace the gaskets.

If You Cannot Identify or Correct the Source of Malfunction:

1. Place the water heater electrical disconnect switch in the OFF position.
2. Close the cold water inlet valve to the heater.
3. Contact a Qualified Service Agency in your area.

Replacement Parts

Call the telephone number listed on this manual for assistance in locating replacement parts. When ordering parts, specify complete model number, serial number (see rating plate), quantity, and name of part desired. Standard hardware items should be purchased locally.

10 Diagrams

Figure 10-1 Wiring Diagram

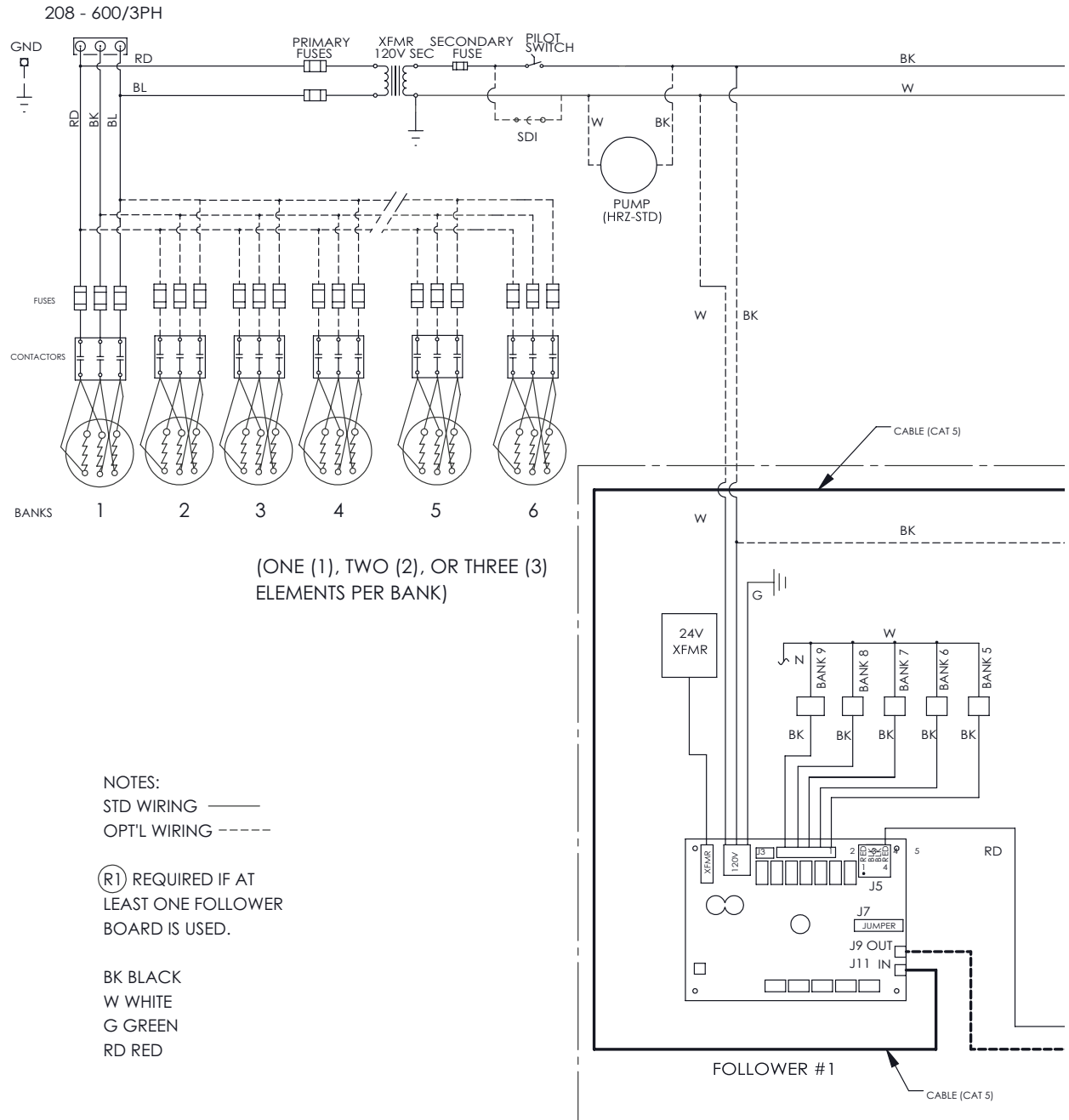

10 Diagrams *(continued)*

Figure 10-1 Wiring Diagram *(continued)*

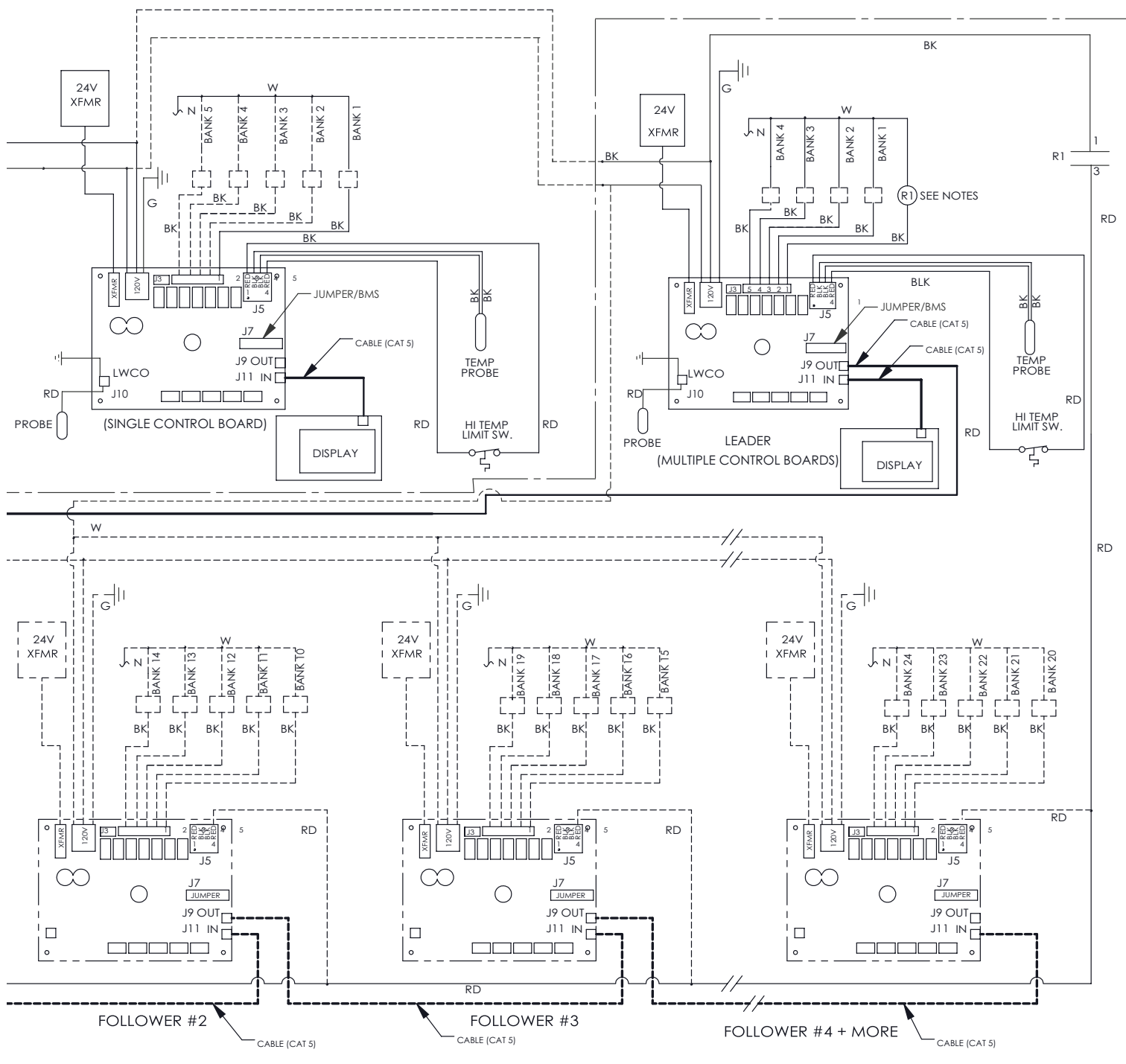

Revision Notes: *Revision A (PCP# 3000005344 / CN# 500005576) initial release.*

Revision B (PCP #3000054496 / CN #500041133) reflects the removal of the "circulating pump" paragraph on page 12.

Revision C (PCP #3000060820 / CN #500046810) reflects the addition of a dielectric notice on page 12.