

# CleanShot™

# 2050 PSI

*Owner's Manual / Manual del Propietario*

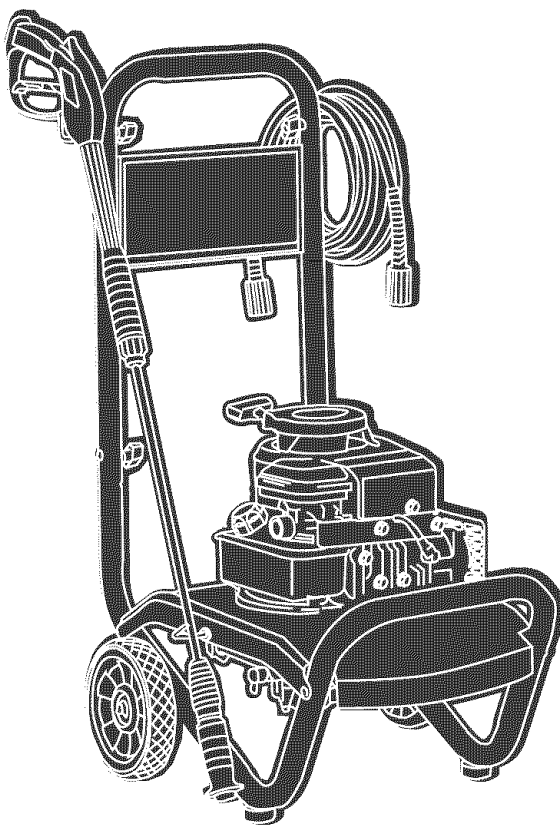

Questions? Help is just a moment away!  
Preguntas? La ayuda es justa un momento lejos!  
Call: **Pressure Washer Helpline**

Llame: **Línea Directa del Lavador a Presión - 1-800-743-4115** M-F 8-5 CT

CleanShot™ is a trademark of Briggs & Stratton Power Products.

CleanShot™ es una marca registrada de Briggs & Stratton Power Products.

**BRIGGS & STRATTON POWER PRODUCTS GROUP, LLC**  
**JEFFERSON, WISCONSIN, U.S.A.**



Model No. 020244-0 (2050 PSI Pressure Washer) Manual No. 195950GS Revision 0 (10/08/2004)



## TABLE OF CONTENTS

Safety Rules . . . . . 2-4  
 Know Your Pressure Washer . . . . . 5  
 Assembly . . . . . 6-7  
 Operation . . . . . 8-11  
 Product Specifications . . . . . 12  
 Maintenance . . . . . 12-14  
 Storage . . . . . 15  
 Troubleshooting . . . . . 16  
 Warranty . . . . . 17

## EQUIPMENT DESCRIPTION

 **Read this manual carefully and become familiar with your pressure washer. Know its applications, its limitations and any hazards involved.**

This manual contains information for a pressure washer that operates at 2,050 PSI at a flow rate of 1.9 gallons per minute. This high quality residential system features 7" wheels, axial cam pump with stainless steel pistons, automatic cool down system, chemical injection system, adjustable spray nozzle. Includes safety goggles, heavy duty 25' hose, and more.

Every effort has been made to ensure that information in this manual is accurate and current. However, we reserve the right to change, alter or otherwise improve the product and this document at any time without prior notice.











## SAFETY RULES

 **This is the safety alert symbol. It is used to alert you to potential personal injury hazards. Obey all safety messages that follow this symbol to avoid possible injury or death.**

The safety alert symbol () is used with a signal word (DANGER, CAUTION, WARNING), a pictorial and/or a safety message to alert you to hazards. **DANGER** indicates a hazard which, if not avoided, will result in death or serious injury. **WARNING** indicates a hazard which, if not avoided, could result in death or serious injury. **CAUTION** indicates a hazard which, if not avoided, might result in minor or moderate injury. **CAUTION**, when used **without** the alert symbol, indicates a situation that could result in equipment damage. Follow safety messages to avoid or reduce the risk of injury or death.

 <b>WARNING</b>
<b>The engine exhaust from this product contains chemicals known to the State of California to cause cancer, birth defects, or other reproductive harm.</b>

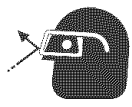
## Hazard Symbols and Meanings

		
Toxic Fumes	Electrical Shock	
		
Slippery Surface	Fall	Fluid Injection
		
Fire	Explosion	Hot Surface
		
Moving Parts	Flying Objects	Kickback









**⚠ WARNING**

 Running engines produce heat. Temperature of muffler and nearby areas can reach or exceed 150°F (65°C).

 Severe burns can occur on contact. Combustible debris, such as leaves, grass, brush, etc. can catch fire.

- DO NOT touch hot surfaces.
- Allow equipment to cool before touching.
- The pressure washer must be at least 5 feet from structures having combustible walls and/or other combustible materials.
- Keep at least 3 feet of clearance on all sides of pressure washer for adequate cooling, maintenance and servicing.
- In the State of California a spark arrester is required by law (Section 4442 of the California Public Resources Code). Other states may have similar laws. Federal laws apply on federal lands. If you equip the muffler with a spark arrester, it must be maintained in effective working order.

**⚠ WARNING**

 Starter and other rotating parts can entangle hands, hair, clothing, or accessories.

- DO NOT wear loose clothing, jewelry or anything that may be caught in the starter or other rotating parts.
- Tie up long hair and remove jewelry.

**⚠ WARNING**

 High pressure spray can cause paint chips or other particles to become airborne.

- Always wear eye protection when using this equipment or in vicinity of where equipment is in use.

**⚠ WARNING**

 Unintentional sparking can result in fire or electric shock.



**WHEN ADJUSTING OR MAKING REPAIRS TO YOUR PRESSURE WASHER**

- Disconnect spark plug wire from spark plug and place wire where it cannot contact spark plug.

**⚠ CAUTION**

Excessively high or low operating speeds increase risk of injury and damage to pressure washer.

- DO NOT tamper with governed speed.
- DO NOT operate pressure washer above rated pressure.

**⚠ CAUTION**

A pressure washer produces a high pressure spray which increases risk of injury and damage to unit.

- DO NOT secure spray gun in open position.
- DO NOT leave spray gun unattended while machine is running.
- NEVER use a spray gun which does not have a trigger lock or trigger guard in place and in working order.
- Always be certain spray gun, nozzles and accessories are correctly attached.

**CAUTION**

High pressure spray may damage fragile items including glass.

- DO NOT point spray gun at glass when in jet spray mode.
- NEVER aim spray gun at plants.

**CAUTION**

Improper treatment of pressure washer can damage it and shorten its life.

- If you have questions about intended use, ask dealer or contact Briggs & Stratton Power Products.
- NEVER operate units with broken or missing parts, or without protective housing or covers.
- DO NOT by-pass any safety device on this machine.
- Before starting pressure washer in cold weather, check all parts of the equipment to be sure ice has not formed there.
- NEVER move machine by pulling on high pressure hose. Use handle provided on unit.
- Check fuel system for leaks or signs of deterioration, such as chafed or spongy hose, loose or missing clamps, or damaged tank or cap. Correct all defects before operating pressure washer.
- This equipment is designed to be used with Briggs & Stratton Power Products authorized parts **ONLY**. If equipment is used with parts that DO NOT comply with minimum specifications, user assumes all risks and liabilities.



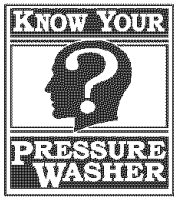

## KNOW YOUR PRESSURE WASHER

Read this owner's manual and safety rules before operating your pressure washer.

Compare the illustrations with your pressure washer to familiarize yourself with the locations of various controls and adjustments. Save this manual for future reference.

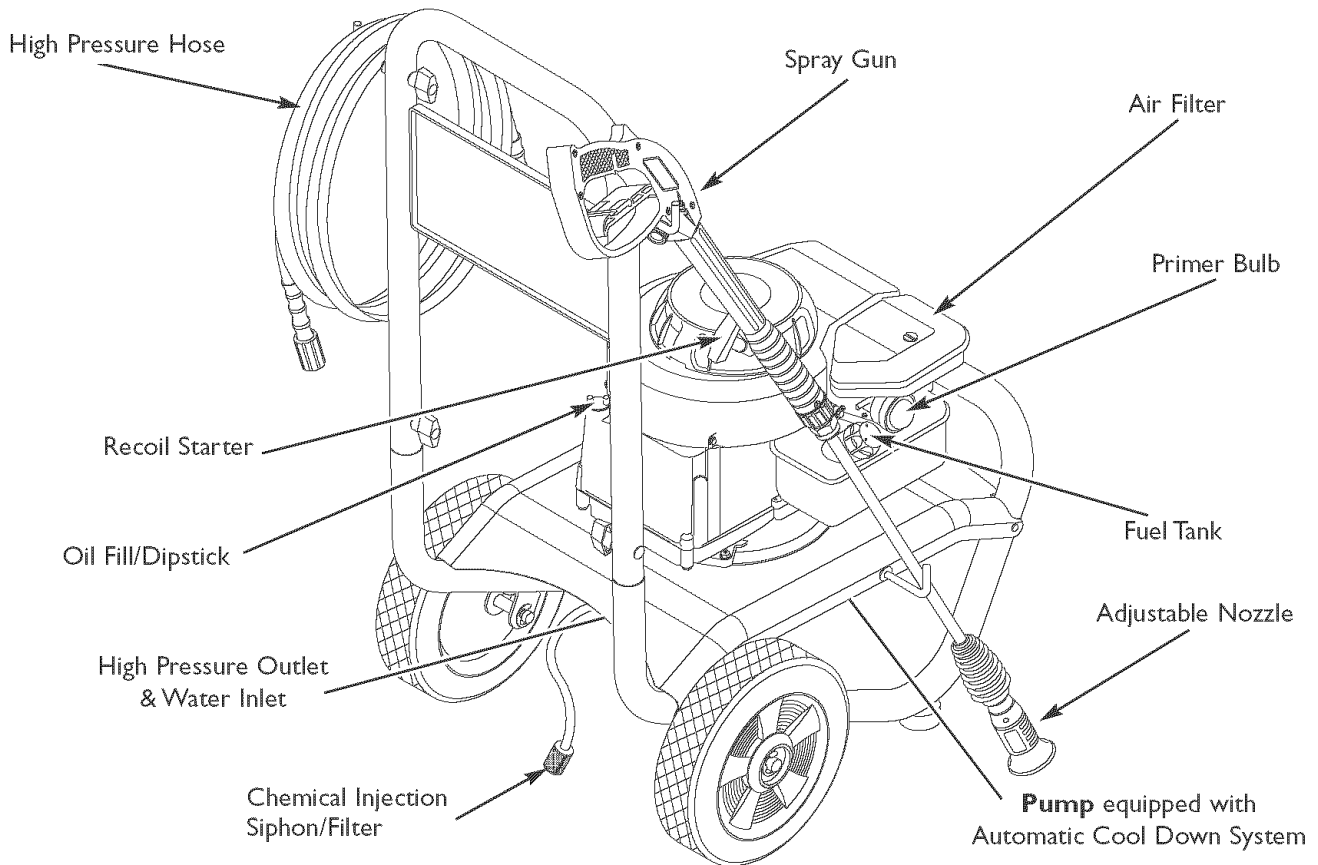

**Adjustable Nozzle** — Always attached to nozzle extension. Adjustable nozzle allows you to adjust spray pressure and spray pattern.

**Air Filter** — Protects engine by filtering dust and debris out of intake air.

**Automatic Cool Down System** — Cycles water through pump when water reaches 125°-155°F. Warm water will discharge from pump onto ground. This system prevents internal pump damage.

**Chemical Injection Siphon/Filter** — Use to siphon detergent or other pressure washer chemicals into the low pressure stream.

**High Pressure Hose** — Connect one end to water pump and the other end to spray gun.

**High Pressure Outlet** — Connection for high pressure hose.

**Data Tag (not shown, near rear of base plate)** — Provides model and serial number of pressure washer. Please have these readily available if calling for assistance.

**Oil Fill/Dipstick** — Check and fill with oil here.

**Primer Bulb** — Prepares a cold engine for starting.

**Pump** — Develops high pressure.

**Recoil Starter** — Used for starting the engine manually.

**Spray Gun** — Controls the application of water onto cleaning surface with trigger device. Includes trigger lock.

**Water Inlet** — Connection for garden hose.

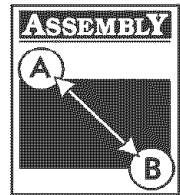

## ASSEMBLY

**IMPORTANT:** Read entire owner's manual before you attempt to assemble or operate your new pressure washer.

### Remove Pressure Washer From Carton

1. Remove the parts bag, accessories, and inserts included with pressure washer.
2. Slice two corners at the end of carton from top to bottom so the panel can be folded down flat.
3. Remove pressure washer from carton.

### Carton Contents

Items in the carton include:

- Main Unit
- Handle
- High Pressure Hose
- Spray Gun
- Adjustable Nozzle Extension
- Safety Goggles
- Oil Bottle
- Parts Bag (which includes the following):
  - Owner's Manual
  - Engine Manual
  - Owner's Registration Card
  - Handle Fastening Hardware Kit (which includes):
    - Carriage Bolts (2)
    - "L" Hooks (2)
    - Plastic Knobs (4)

## PREPARING PRESSURE WASHER FOR USE

If you have any problems with the assembly of your pressure washer or if parts are missing or damaged, call the pressure washer helpline at **1-800-743-4115**. If calling for assistance, please have the model, revision, and serial number from the data tag available.

**To prepare your pressure washer for operation, you will need to perform these tasks:**

1. Fill out and send in registration card.
2. Attach handle to main unit.
3. Add oil to engine crankcase.
4. Add fuel to fuel tank.

5. Connect high pressure hose to spray gun and pump.
6. Connect water supply to pump.
7. Attach nozzle extension to spray gun.

### Attach Handle

1. Place handle assembly onto handle supports connected to main unit. Make sure holes in handle align with holes on handle supports (Figure 1).

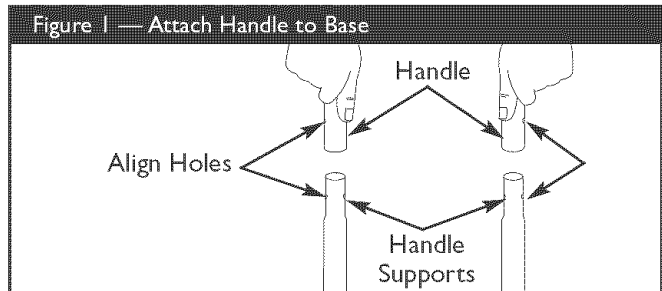

**NOTE:** It may be necessary to move the handle supports from side to side in order to align the handle so it will slide over the handle supports.

2. Insert carriage bolts through holes from outside of unit and attach a plastic knob from inside of unit (Figure 2). Tighten by hand.

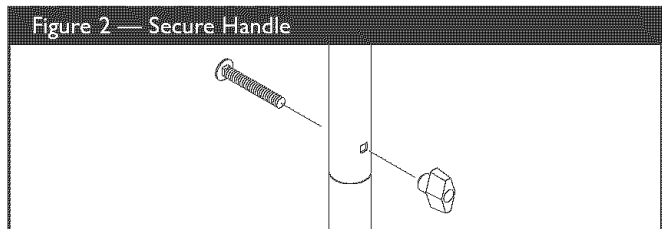

3. Insert one "L" hook through hole just above billboard on left side of handle (viewing from rear of unit). Hold hook in place and attach a plastic knob from inside of unit (Figure 3). Tighten by hand.

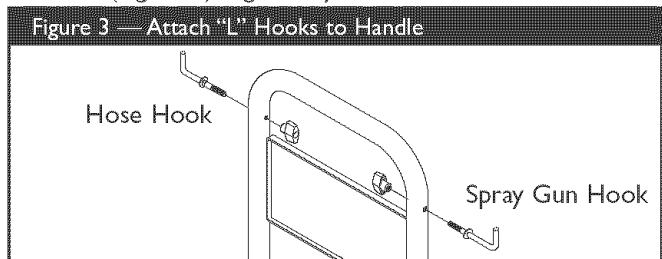

4. Insert other "L" hook through hole just above billboard on right side of handle (viewing from rear of unit). Hold hook in place and attach a plastic knob from inside of unit (Figure 3). Tighten by hand.











## Pressure Washer Rinsing

### For Rinsing:

1. Slide the nozzle backward to high pressure, press the trigger and wait for the detergent to clear.

**NOTE:** You can also stop detergent from flowing by simply removing chemical injection hose from bottle.

2. Keep the spray gun a safe distance from the area you plan to spray.

### **WARNING**



High pressure spray could cause you to fall if you are too close to the cleaning surface.

- Keep spray nozzle between 8 to 24 inches away from cleaning surface.
- Operate this unit on a stable surface.
- Be extremely careful if you must use the pressure washer from a ladder, scaffolding or any other relatively unstable location.
- Firmly grasp spray gun with both hands when using high pressure spray to avoid injury if gun kicks back.

3. Apply a high pressure spray to a small area, then check the surface for damage. Adjust spray pattern or move spray nozzle further away from cleaning surface, if necessary.
4. Start at the top of the area to be rinsed, working down with same overlapping strokes as you used for washing and applying detergent.

## Cleaning Chemical Injection Hose

If you used the chemical injection hose, you must flush it with clean water before stopping the engine.

1. Place chemical injection hose in a bucket full of clean water.
2. Slide adjustable nozzle forward to low pressure position. Flush for 1-2 minutes.

## Automatic Cool Down System (Thermal Relief)

If you run the engine on your pressure washer for 3-5 minutes without pressing the trigger on the spray gun, circulating water in the pump can reach temperatures above 125°F. The system engages to cool the pump by **discharging the warm water onto the ground.**





## Check In-Line Filter

Refer to Figure 13 and service the in-line filter if it becomes clogged, as follows:

Figure 13 — Clean In-Line Filter

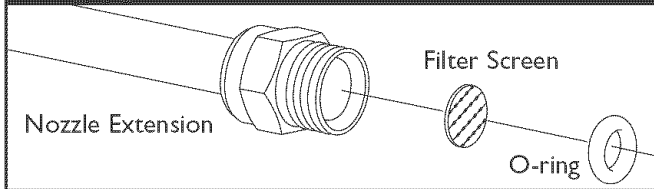

1. Detach spray gun and nozzle extension from high pressure hose. Detach nozzle extension from spray gun and remove o-ring and screen from nozzle extension. Flush screen, spray gun, and adjustable nozzle extension with clean water to clear debris.
2. Place in-line filter screen into threaded end of nozzle extension. Direction does not matter. Push screen in with eraser end of pencil until it rests flat at bottom of opening. Take care not to bend the screen.
3. Place o-ring into recess. Push o-ring snugly against in-line filter screen.
4. Assemble nozzle extension to spray gun, as described earlier in manual.

## Nozzle Maintenance

A pulsing sensation felt while squeezing the spray gun trigger may be caused by excessive pump pressure. The principal cause of excessive pump pressure is a nozzle clogged or restricted with foreign materials, such as dirt, etc. To correct the problem, immediately clean the orifice following these instructions:

1. Shut off engine and turn off water supply.
2. Remove orifice from end of nozzle extension. Separate nozzle extension from spray gun. Twist nozzle clockwise to stream position. Using a 2mm (5/64) allen wrench, remove orifice from end of nozzle extension (Figure 14).

Figure 14 — Removing and Cleaning Orifice

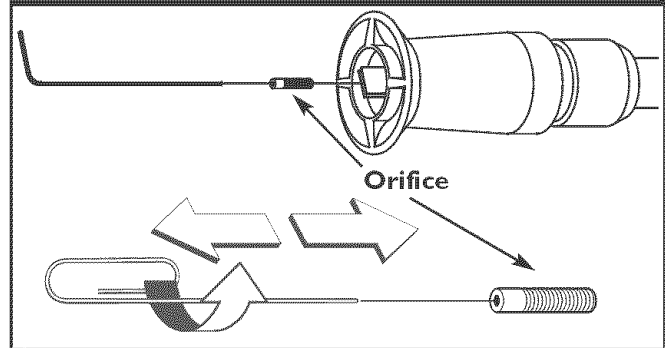

3. Remove in-line filter from other end of nozzle extension.
4. Use a small paper clip to free any foreign material clogging or restricting orifice (Figure 14).
5. Using a garden hose, remove additional debris by back flushing water through nozzle extension (Figure 15). Back flush between 30 to 60 seconds. Turn adjustable nozzle extension to stream spray and move nozzle from low to high while flushing.

Figure 15 — Backflushing the Nozzle

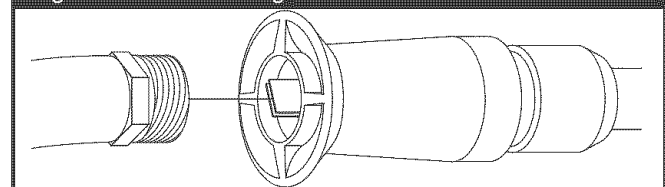

6. Reinstall orifice and in-line filter into nozzle extension. **DO NOT** overtighten orifice with allen wrench.
7. Reconnect nozzle extension to spray gun.
8. Reconnect water supply, turn on water, and start engine.
9. Test pressure washer by operating with nozzle in high and low positions.





## PREPARING THE UNIT FOR STORAGE

Water should not remain in the unit for long periods of time. Sediments or minerals can deposit on pump parts and “freeze” pump action. If you do not plan to use the pressure washer for more than 30 days, follow this procedure:

1. Flush chemical injection hose by placing filter into a pail of clean water while running pressure washer in low pressure mode (adjustable nozzle in forward position). Flush for one to two minutes.
2. Shut off engine and let it cool, then remove high pressure and garden hoses. Disconnect spark plug wire from spark plug.
3. Empty pump of all pumped liquids by pulling recoil handle about 6 times. This should remove most liquid in pump.
4. Use PumpSaver to prevent corrosion build up and freezing of pump.
5. Store unit in a clean, dry area.

### Protecting the Pump

To protect the pump from damage caused by mineral deposits or freezing, use PumpSaver to treat pump. This prevents freeze damage and lubricates pistons and seals.

**NOTE:** PumpSaver is available as an optional accessory. It is not included with the pressure washer. Contact the nearest authorized service center to purchase PumpSaver.

To use PumpSaver, make sure the pressure washer is turned off and disconnected from supply water. Read and follow all instructions and warnings given on the PumpSaver container.

### CAUTION

You must protect your unit from freezing temperatures.

- Failure to do so will permanently damage your pump and render your unit inoperable.
- Freeze damage is not covered under warranty.

### CAUTION

Read and follow all cautions and warnings on the PumpSaver can label.

- Always wear eye protection when using PumpSaver.

### CAUTION

PumpSaver will drip from pump after treatment and will stain wood and concrete.

- Protect surfaces from dripping PumpSaver.

**NOTE:** If PumpSaver is not available, draw RV antifreeze (non-alcohol) into the pump by pouring the solution into a 3-foot section of garden hose connected to inlet adapter and pulling recoil handle twice.

## STORING THE ENGINE

See the engine owner’s manual for instructions on how to properly prepare the engine for storage.

























## Enjuague de la Máquina Lavadora a Presión

### Para Enjuague:

1. Deslice la boquilla hacia atrás a la presión alta y apriete el disparador. Llevará un pocos segundos para el detergente a claro.

**NOTA:** También puede detener la circulación del detergente retirando el tubo de succión del recipiente.

2. Mantenga la pistola de rociado a una distancia segura del área que planea rociar.

**ADVERTENCIA**

 El rociado de la alta presión podría hacerlo caer si está muy cerca de la superficie de limpieza.

- Mantenga la boquilla de rociado de 8 a 24 pulgadas de la superficie de limpieza.
- Opere y almacene esta unidad sobre una superficie estable.
- Sea extremadamente cuidadoso si usa la máquina lavadora a presión desde una escalera, andamio o cualquier superficie relativamente inestable.
- Sujete la pistola de la hidrolavadora firmemente con ambas manos cuando utilice el rociado a alta presión. De esta manera evitará lesiones producidas por el posible golpe de la pistola hacia atrás.

3. Aplique un rociado de alta presión en un área pequeña, después revise si la superficie presenta daños. Si no encuentra daños, puede continuar con el trabajo de limpieza.
4. Comience en la parte superior del área que va a enjuagar, dirigiéndose hacia abajo con los mismos movimientos superpuestos que utilizó para el limpieza.

## Limpiando el Tubo

Si usted usó el tubo, usted debe lavarlo con agua limpia antes de parar el motor.

1. Coloque el filtro y la inyección química en un balde lleno de agua limpia.
2. Deslice boquilla ajustable hacia adelante al modo bajo de la presión. Lave de 1 a 2 minutos.

## Sistema de Enfriamiento Automático (Alivio Térmico)

El agua que circula dentro de la bomba puede alcanzar temperaturas entre los 125°-155°F si hace funcionar el motor de su máquina lavadora a presión de 3 a 5 minutos sin oprimir el gatillo de la pistola de rociado. Cuando el agua alcanza dicha temperatura, el sistema de enfriamiento automático se activa y enfría la bomba **descargando agua caliente en el piso.**









## REPARACION DE AVERIAS

Problema	Causa	Solución
<p><b>La bomba presenta los siguientes problemas: no produce presión, produce una presión errada, traqueteo, pérdida de presión, bajo volumen de agua.</b></p>	<ol style="list-style-type: none"> <li>1. La boquilla está en el modo de baja presión.</li> <li>2. La entrada de agua está bloqueada.</li> <li>3. Suministro de agua inadecuado.</li> <li>4. La manguera de entrada está doblada o presenta fugas.</li> <li>5. El colador de la manguera de entrada está tapado.</li> <li>6. El suministro de agua está por encima de los 100°F.</li> <li>7. La manguera de alta presión está bloqueada o presenta fugas.</li> <li>8. La pistola presenta fugas.</li> <li>9. La boquilla está obstruida.</li> <li>10. Bomba defectuosa.</li> </ol>	<ol style="list-style-type: none"> <li>1. Mueva la boquilla hacia atrás para el modo de alta presión.</li> <li>2. Limpie la entrada.</li> <li>3. Proporcione flujo de agua adecuado.</li> <li>4. Estire la manguera de entrada, coloque un parche en la fuga.</li> <li>5. Revise y limpie el colador de la manguera de entrada.</li> <li>6. Proporcione suministro de agua más fría.</li> <li>7. Retire las obstrucciones de la manguera de salida.</li> <li>8. Reemplace la pistola.</li> <li>9. Limpie la boquilla.</li> <li>10. Póngase en contacto con el centro de servicio Briggs &amp; Stratton Power Products.</li> </ol>
<p><b>El detergente no se mezcla con el rociado.</b></p>	<ol style="list-style-type: none"> <li>1. El tubo de succión de detergente no está sumergido.</li> <li>2. El filtro de químicos está tapado.</li> <li>3. Sucio en el filtro de la línea.</li> <li>4. La boquilla está en el modo de alta presión.</li> </ol>	<ol style="list-style-type: none"> <li>1. Coloque el tubo de succión de detergente en el detergente.</li> <li>2. Limpie o reemplace el filtro/tubo de succión de detergente.</li> <li>3. Vea "Cheque En el Filtro de la Línea".</li> <li>4. Mueva la boquilla hacia adelante para el modo de baja presión.</li> </ol>
<p><b>El motor funciona bien cuando no tiene cargas, pero funciona "mal" cuando se conecta una carga.</b></p>	<p>La velocidad del motor es demasiado lenta.</p>	<p>Mueva el control de la válvula de regulación a la posición FAST (RAPIDO). Si el motor continúa funcionando mal, póngase en contacto con el centro de servicio Briggs and Stratton.</p>
<p><b>El lavadora de presión se apaga durante la operación.</b></p>	<p>Sin gasolina.</p>	<p>Llene el tanque de combustible.</p>

