

VEVOR®

TOUGH TOOLS, HALF PRICE

Technical Support and E-Warranty Certificate
www.vevor.com/support

DRUM-SHIELD USER MANUAL

Manufacturer: Shanghaimuxinmuyeyouxiangongsi

Address: Shuangchenglu 803nong11hao1602A-1609shi, baoshanqu, shanghai 200000 CN.

Imported to AUS: SIHAO PTY LTD. 1 ROKEVA STREETEASTWOOD NSW 2122 Australia

Imported to USA: Sanven Technology Ltd. Suite 250, 9166 Anaheim Place, Rancho Cucamonga, CA 91730



E-CrossStu GmbH
Mainzer Landstr.69, 60329 Frankfurt am Main.



YH CONSULTING LIMITED.
C/O YH Consulting Limited Office 147, Centurion House,
London Road. Staines-upon-Thames. Surrey. TW18 4AX

We continue to be committed to provide you tools with competitive price. "Save Half", "Half Price" or any other similar expressions used by us only represents an estimate of savings you might benefit from buying certain tools with us compared to the major top brands and does not necessarily mean to cover all categories of tools offered by us. You are kindly reminded to verify carefully when you are placing an order with us if you are actually Saving Half in comparison with the top major brands.

VEVOR®

TOUGH TOOLS, HALF PRICE

Drum-Shield

MODEL: OK-24017

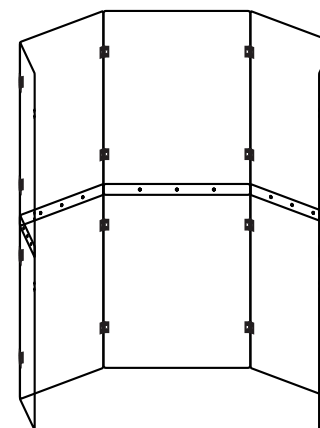





(The picture is for reference only, please refer to the actual object)

NEED HELP? CONTACT US!

Have product questions? Need technical support? Please feel free to contact us:

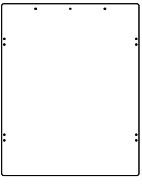
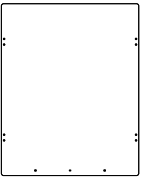
Technical Support and E-Warranty Certificate
www.vevor.com/support

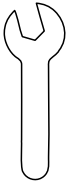
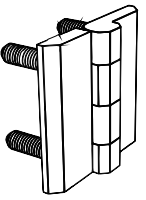
This is the original instruction, please read all manual instructions carefully before operating. VEVOR reserves a clear interpretation of our user manual. The appearance of the product shall be subject to the product you received. Please forgive us that we won't inform you again if there are any technology or software updates on our product.

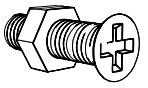
Component	1 A  Bottom without holes	2 B  Bottom with holes	3 	4 	5 	6 	7 
	Name	Lower acrylic plate	Upper acrylic plate	cross screwdriver	wrench	Hinge	Nut
Quantity	5pcs	5pcs	1pcs	1pcs	16pcs	64pcs	15pcs

Assembly of lower acrylic board

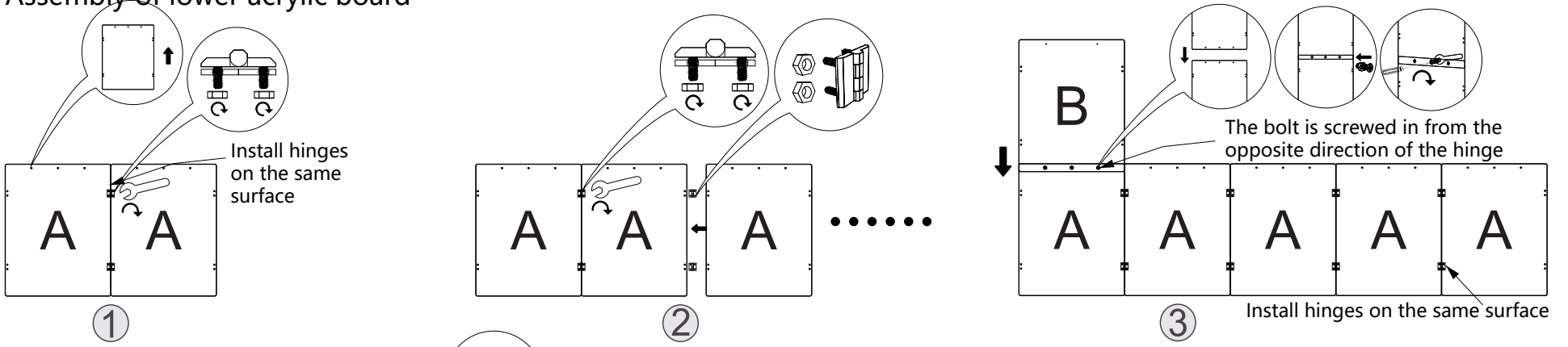

Assembly of Upper acrylic plate

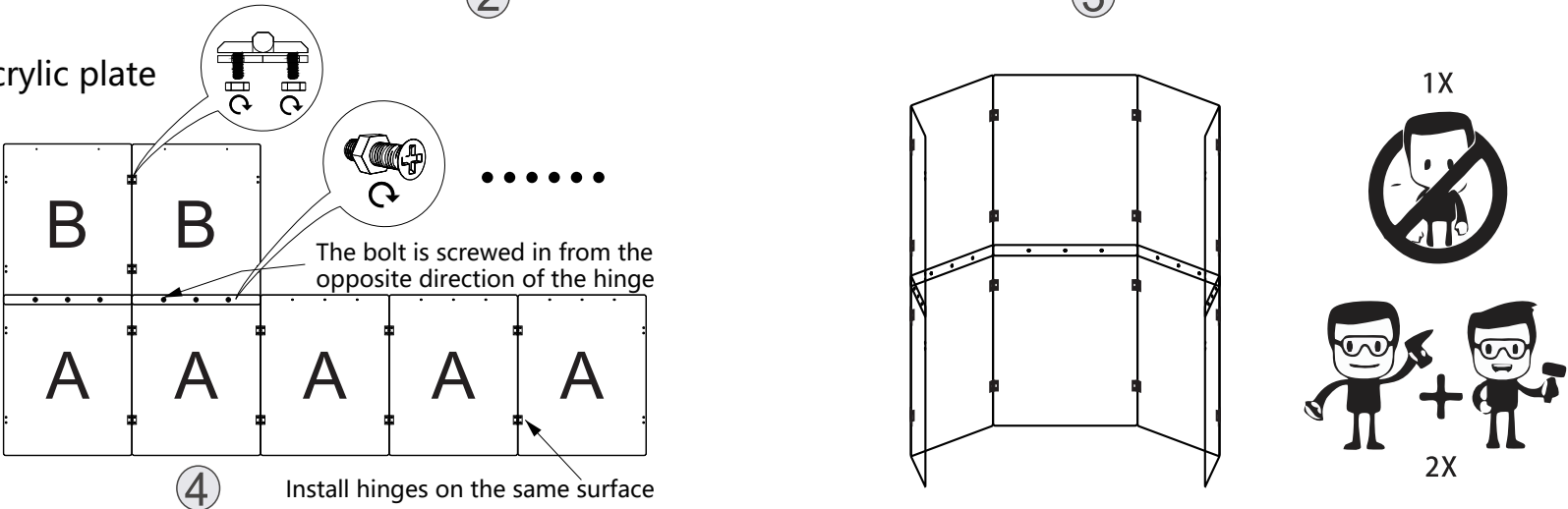

VEVOR[®]

TOUGH TOOLS, HALF PRICE

Assistance technique et certificat de garantie
électronique www.vevor.com/support

MANUEL D'UTILISATION DU DRUM-SHIELD

Fabricant : Shanghaimuxinmuyeyouxiangongsi Adresse :
Shuangchenglu 803nong11hao1602A-1609shi, baoshanqu, shanghai 200000 CN.

Importé en Australie : SIHAO PTY LTD. 1 ROKEVA STREET EASTWOOD NSW
2122 Australie

Importé aux États-Unis : Sanven Technology Ltd. Suite 250, 9166 Anaheim Place, Rancho
Cucamonga, CA 91730



E-CrossStu GmbH
Mainzer Landstr.69, 60329 Francfort-sur-le-Main.



YH CONSULTING LIMITÉE.
C/O YH Consulting Limited Bureau 147, Centurion House,
London Road, Staines-upon-Thames, Surrey, TW18 4AX

Nous continuons à nous engager à vous fournir des outils à des prix compétitifs.
« Économisez la moitié », « Moitié prix » ou toute autre expression similaire utilisée par nous ne représente qu'une estimation des économies que vous pourriez réaliser en achetant certains outils chez nous par rapport aux grandes marques et ne couvre pas nécessairement toutes les catégories d'outils que nous proposons. Nous vous rappelons de bien vouloir vérifier soigneusement lorsque vous passez une commande chez nous si vous économisez réellement la moitié par rapport aux grandes marques.

VEVOR[®]

TOUGH TOOLS, HALF PRICE

Tambour-Protecteur

MODÈLE : OK-24017

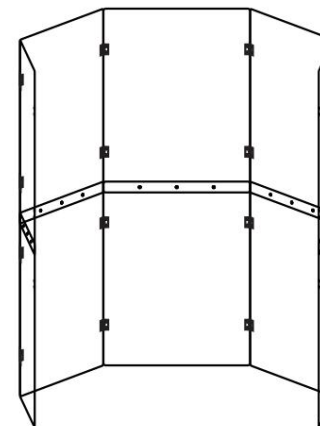





(L'image est à titre de référence uniquement, veuillez vous référer à l'objet réel)

BESOIN D'AIDE? CONTACTEZ-NOUS!

Vous avez des questions sur nos produits ? Vous avez besoin d'assistance technique ?
N'hésitez pas

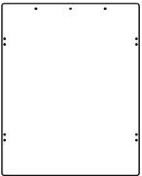
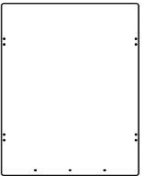
à nous contacter : Assistance technique et certificat de garantie
électronique www.vevor.com/support

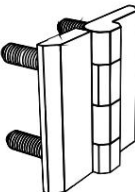
Il s'agit de la notice d'utilisation d'origine. Veuillez lire attentivement toutes les instructions du manuel avant de l'utiliser. VEVOR se réserve le droit d'interpréter clairement notre manuel d'utilisation. L'apparence du produit dépend du produit que vous avez reçu. Veuillez nous excuser, nous ne vous informerons plus en cas de mise à jour technologique ou logicielle de notre produit.

Composant	1 A 	2 B 	3 	4 	5 	6 	7 
Nom	Plaque inférieure en acrylique	Plaque supérieure en acrylique	tournevis cruciforme	clé	Charnière	Noix	Boulons et écrous
Quantité	5pcs	5pcs	1pcs	1pcs	16pcs	64pcs	15pcs

Assemblage du panneau acrylique inférieur

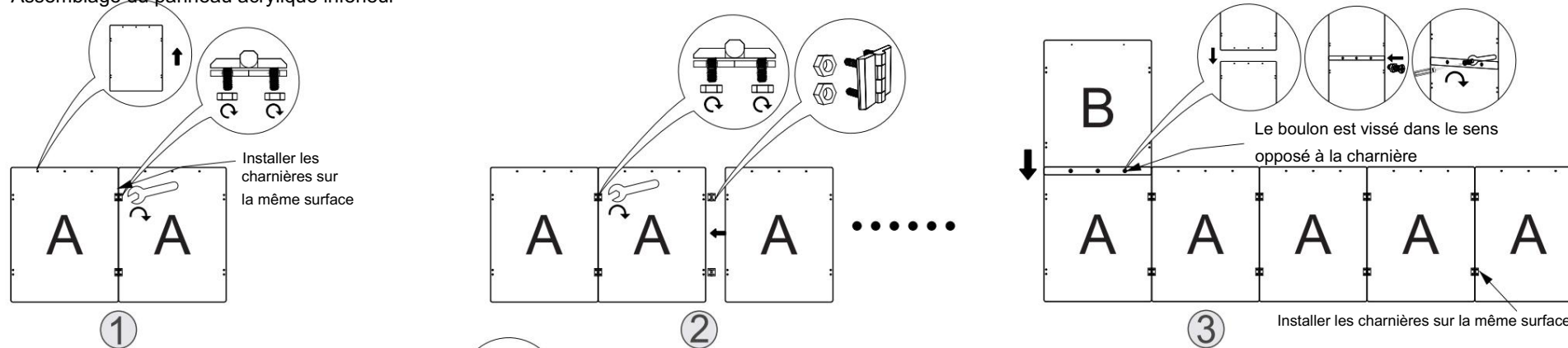

Assemblage de la plaque acrylique supérieure

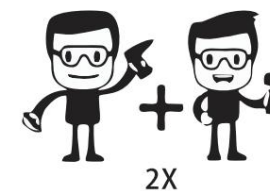
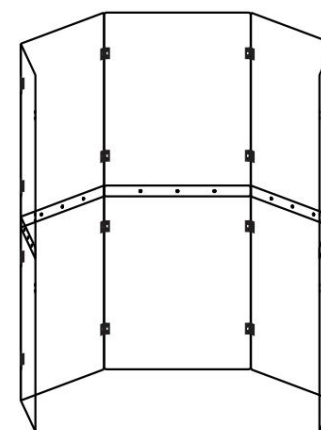
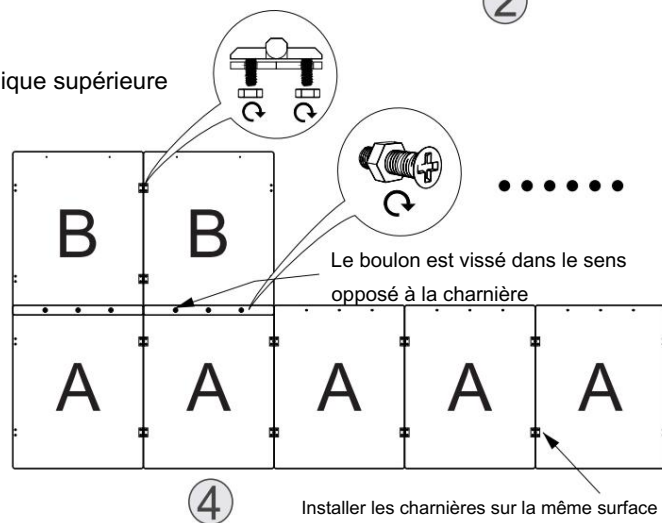

VEVOR®

TOUGH TOOLS, HALF PRICE

Technischer Support und E-Garantie-Zertifikat
www.vevor.com/support

DRUM-SHIELD BENUTZERHANDBUCH

Hersteller: Shanghaimuxinmuyeyouxiangongsi

Adresse: Shuangchenglu 803nong11hao1602A-1609shi, baoshanqu,
Shanghai 200000 CN.

Nach AUS importiert: SIHAO PTY LTD. 1 ROKEVA STREETEASTWOOD NSW
2122 Australien

Importiert in die USA: Sanven Technology Ltd. Suite 250, 9166 Anaheim Place,
Rancho Cucamonga, CA 91730

Vertreter der EG	E-CrossStu GmbH Mainzer Landstr.69, 60329 Frankfurt am Main.
-------------------------	---

UK REP	YH CONSULTING LIMITED. C/O YH Consulting Limited Office 147, Centurion House, London Road, Staines-upon-Thames, Surrey, TW18 4AX
---------------	--

Wir sind weiterhin bestrebt, Ihnen Werkzeuge zu wettbewerbsfähigen Preisen anzubieten. „Sparen Sie die Hälfte“, „Halber Preis“ oder andere ähnliche Ausdrücke, die wir verwenden, stellen nur eine Schätzung der Ersparnis dar, die Sie beim Kauf bestimmter Werkzeuge bei uns im Vergleich zu den großen Topmarken erzielen können, und decken nicht unbedingt alle von uns angebotenen Werkzeugkategorien ab. Wir möchten Sie freundlich daran erinnern, bei der Bestellung bei uns sorgfältig zu prüfen, ob Sie im Vergleich zu den großen Topmarken tatsächlich die Hälfte sparen.

VEVOR®

TOUGH TOOLS, HALF PRICE

Trommel-Schild

MODELL: OK-24017

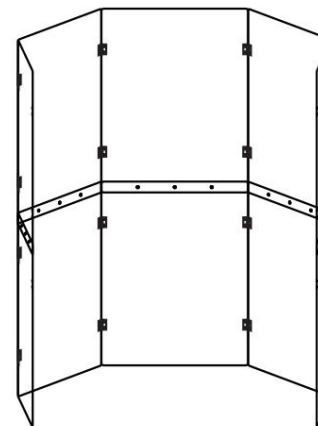





(Das Bild dient nur als Referenz, bitte beziehen Sie sich auf das tatsächliche Objekt)

Brauchen Sie Hilfe? Kontaktieren Sie uns!

Haben Sie Fragen zum Produkt? Benötigen Sie technischen Support? Bitte kontaktieren Sie uns:

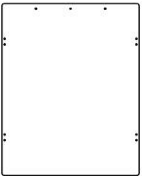
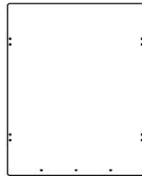
Technischer Support und E-Garantie-Zertifikat www.vevor.com/support

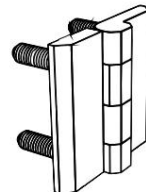
Dies ist die Originalanleitung. Bitte lesen Sie alle Anweisungen sorgfältig durch, bevor Sie das Gerät in Betrieb nehmen. VEVOR behält sich eine klare Auslegung unserer Bedienungsanleitung vor. Das Erscheinungsbild des Produkts richtet sich nach dem Produkt, das Sie erhalten haben. Bitte verzeihen Sie uns, dass wir Sie nicht erneut informieren, wenn es Technologie- oder Software-Updates für unser Produkt gibt.

Komponente	1 A  Boden ohne Löcher	2 B  Boden mit Löchern	3 	4 	5 	6 	7 
	Name	Untere Acrylplatte	Oberer Acrylplatte	Kreuzschraubendreher	Schlüssel	Scharnier	Nuss
Menge	5pcs	5pcs	1pcs	1pcs	16pcs	64pcs	15pcs

Montage der unteren Acrylplatte

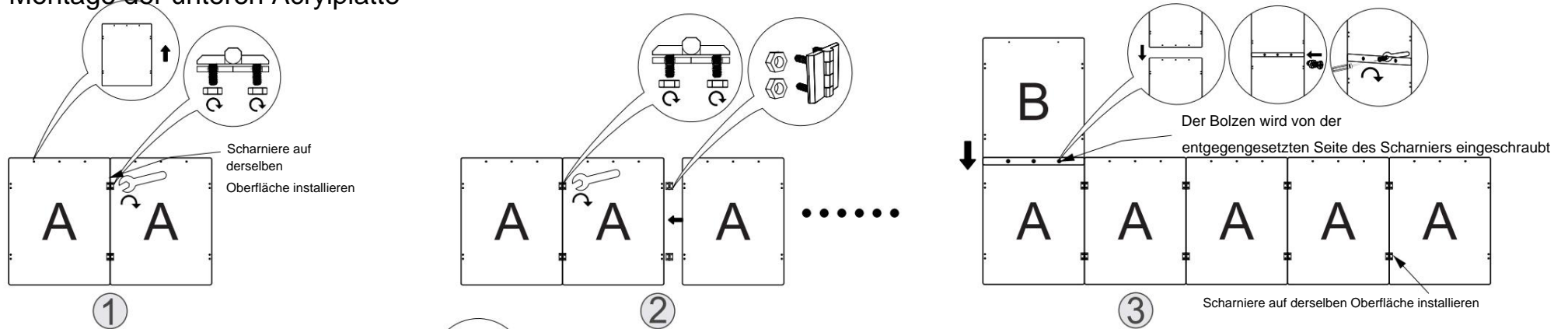

Montage der oberen Acrylplatte

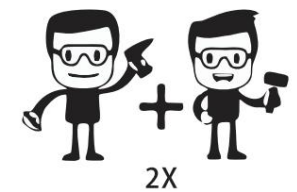
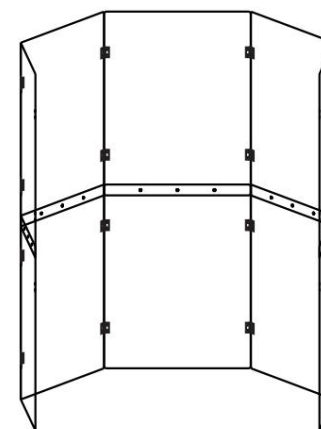
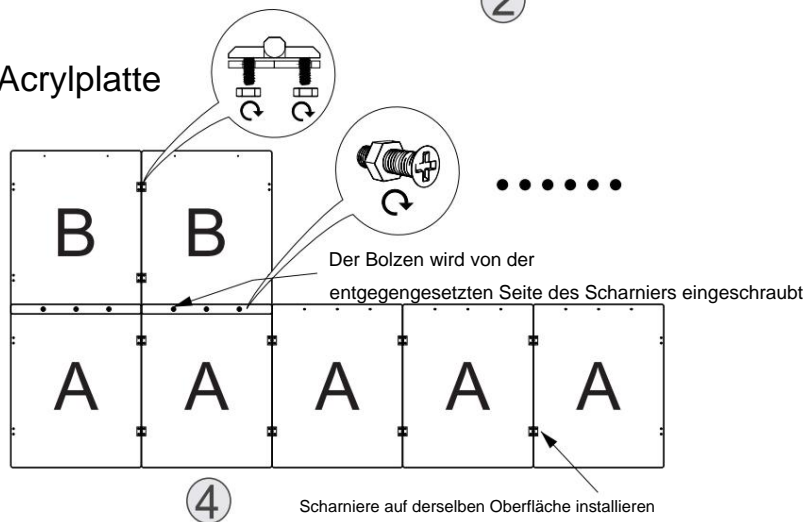

VEVOR[®]

TOUGH TOOLS, HALF PRICE

Supporto tecnico e certificato di garanzia
elettronica www.vevor.com/support

MANUALE D'USO DRUM-SHIELD

Produttore: Shanghaimuxinmuyeyouxiangongsi

Indirizzo: Shuangchenglu 803nong11hao1602A-1609shi, baoshanqu,
shanghai 200000 CN.

Importato in AUS: SIHAO PTY LTD. 1 ROKEVA STREETEASTWOOD NSW
2122 Australia

Importato negli USA: Sanven Technology Ltd. Suite 250, 9166 Anaheim Place,
Rancho Cucamonga, CA 91730

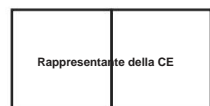

E-CrossStu GmbH
Mainzer Landstr.69, 60329 Francoforte sul Meno.



CONSULENZA YH LIMITATA.
C/O YH Consulting Limited Ufficio 147, Centurion House,
Via Roma, 101, 00186 Roma, Italia

Continuiamo a impegnarci per fornirvi strumenti a prezzi competitivi.
"Risparmia la metà", "Metà prezzo" o qualsiasi altra espressione simile da noi
utilizzata rappresenta solo una stima del risparmio che potresti ottenere acquistando
determinati utensili con noi rispetto ai principali marchi principali e non significa
necessariamente coprire tutte le categorie di utensili da noi offerti. Ti ricordiamo
gentilmente di verificare attentamente quando effettui un ordine con noi se stai
effettivamente risparmiando la metà rispetto ai principali marchi principali.

VEVOR[®]

TOUGH TOOLS, HALF PRICE

Scudo a tamburo

MODELLO: OK-24017

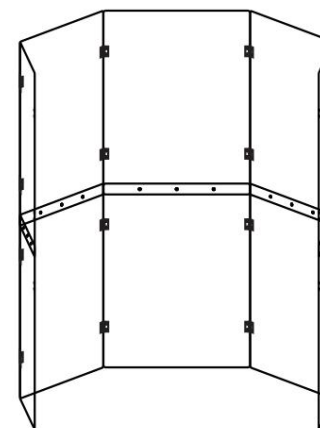

(L'immagine è solo di riferimento, fare riferimento all'oggetto reale)





HAI BISOGNO DI AIUTO? CONTATTACI!

Hai domande sul prodotto? Hai bisogno di supporto tecnico? Non esitare a contattarci:

Supporto

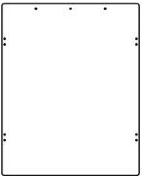
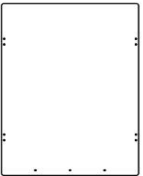
tecnico e certificato di garanzia elettronica www.vevor.com/support

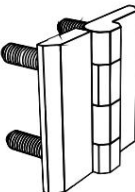
Questa è l'istruzione originale, si prega di leggere attentamente tutte le istruzioni del
manuale prima di utilizzare. VEVOR si riserva una chiara interpretazione del nostro manuale
utente. L'aspetto del prodotto sarà soggetto al prodotto ricevuto. Vi preghiamo di
perdonarci se non vi informeremo di nuovo se ci sono aggiornamenti tecnologici o software sul
nostro prodotto.

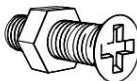
	1 A	2 B	3	4	5	6	7
Componente	 Fondo senza buchi	 Fondo con buchi					
Nome	Piastra acrilica inferiore	Piastra superiore in acrilico	cacciavite a croce	chiave	Cerniera	Noce	Bulloni e dadi
Quantità	5pcs	5pcs	1pcs	1pcs	16pcs	64pcs	15pcs

Montaggio del pannello acrilico inferiore

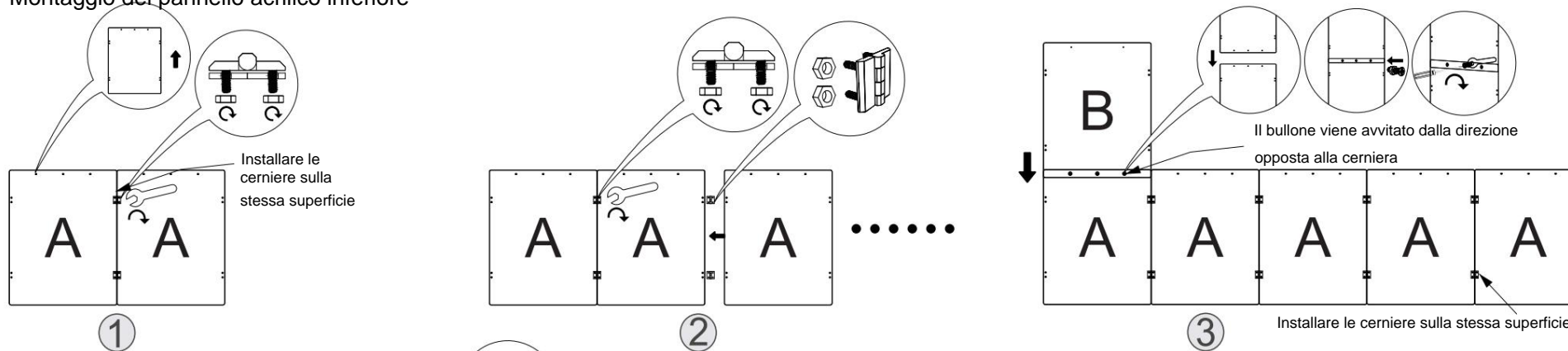

Montaggio della piastra acrilica superiore

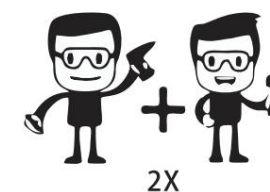
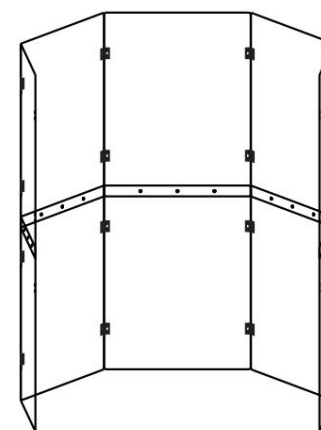
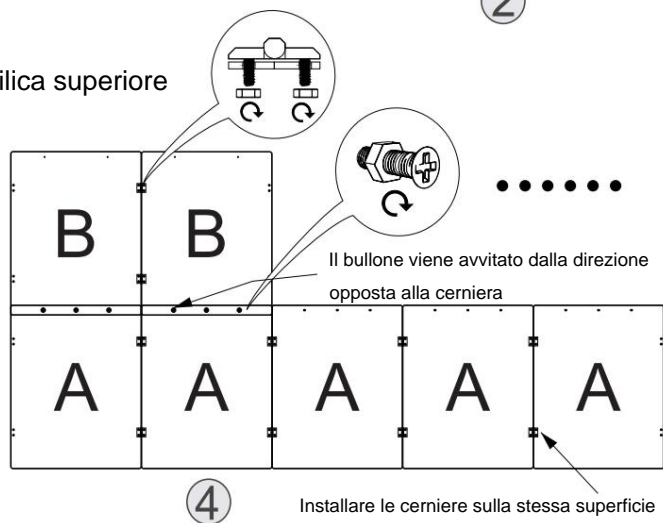

VEVOR[®]

TOUGH TOOLS, HALF PRICE

Soporte técnico y certificado de garantía
electrónica www.vevor.com/support

MANUAL DEL USUARIO DEL PROTECTOR DE TAMBOR

Fabricante: Shanghai muxinmuyeyouxiangongsi Dirección:
Shuangchenglu 803nong11hao1602A-1609shi, baoshanqu, shanghai 200000
CN.
Importado a Australia: SIHAO PTY LTD. 1 ROKEVA STREET EASTWOOD NSW
2122 Australia
Importado a EE. UU.: Sanven Technology Ltd. Suite 250, 9166 Anaheim Place, Rancho
Cucamonga, CA 91730

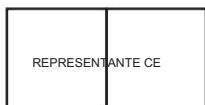

E-CrossStu GmbH
Mainzer Landstr.69, 60329 Fráncfort del Meno.



YH CONSULTING LIMITADA.
C/O YH Consulting Limited Oficina 147, Centurion House,
Carretera de Londres, Staines-upon-Thames, Surrey, TW18 4AX

Seguimos comprometidos a brindarle herramientas a precios competitivos.
"Ahorre la mitad", "mitad de precio" o cualquier otra expresión similar que utilicemos solo representa una estimación del ahorro que podría obtener al comprar ciertas herramientas con nosotros en comparación con las principales marcas y no necesariamente significa que cubra todas las categorías de herramientas que ofrecemos. Le recordamos que, al realizar un pedido con nosotros, verifique cuidadosamente si realmente está ahorrando la mitad en comparación con las principales marcas.

VEVOR[®]

TOUGH TOOLS, HALF PRICE

Protector de tambor

MODELO: OK-24017

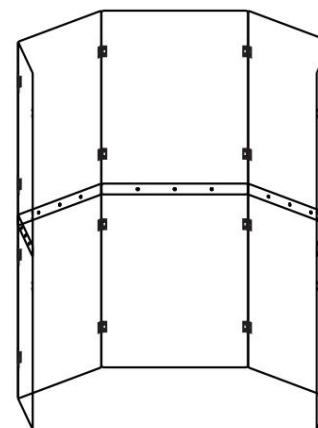





(La imagen es solo de referencia, consulte el objeto real)

¿NECESITA AYUDA? ¡CONTÁCTENOS!

¿Tiene preguntas sobre el producto? ¿Necesita asistencia técnica? No dude en ponerse en contacto con

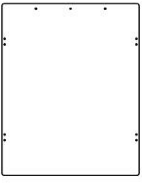
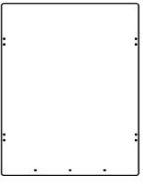
nosotros: Asistencia técnica y certificado de garantía electrónica
www.vevor.com/support

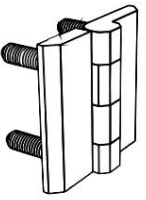
Estas son las instrucciones originales, lea atentamente todas las instrucciones del manual antes de utilizar el producto. VEVOR se reserva una interpretación clara de nuestro manual de usuario. La apariencia del producto estará sujeta al producto que recibió. Perdónenos por no informarle nuevamente si hay actualizaciones de tecnología o software en nuestro producto.

	1 A	2 B	3	4	5	6	7
Componente	 Fondo sin agujeros	 Fondo con agujeros					
Nombre	Placa acrílica inferior	Placa acrílica superior	Destornillador de cruz	llave inglesa	Bisagra	Tuerca	Pernos y tuercas
Cantidad	5pcs	5pcs	1pcs	1pcs	16pcs	64pcs	15pcs

Montaje de tablero acrílico inferior

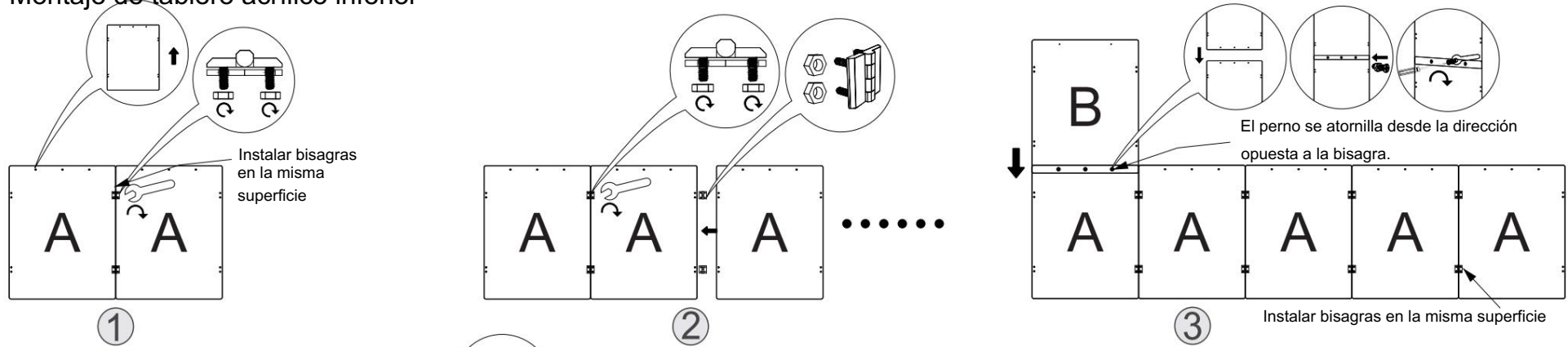

Montaje de placa acrílica superior

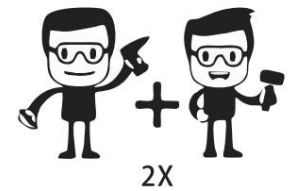
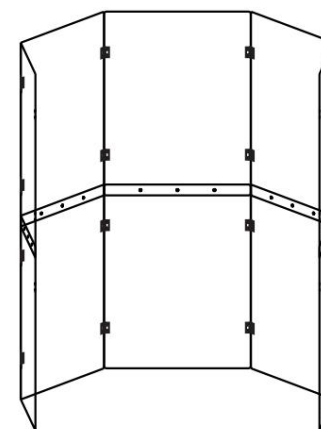
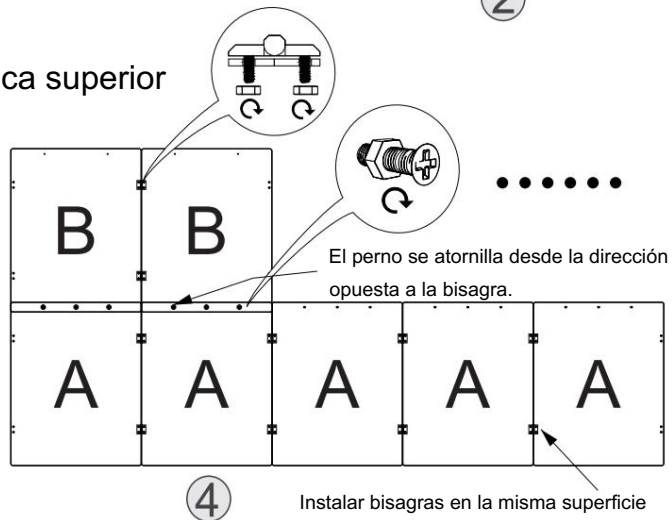

VEVOR[®]

TOUGH TOOLS, HALF PRICE

Wsparcie techniczne i certyfikat gwarancji
elektronicznej www.vevor.com/support

INSTRUKCJA OBSŁUGI DRUM-SHIELD

Producent: Shanghaimuxinmuyeyouxiangongsi Adres:

Shuangchenglu 803nong11hao1602A-1609shi, baoshanqu, szanghaj
200000 CN.

Importowane do AUS: SIHAO PTY LTD. 1 ROKEVA STREETEASTWOOD NSW
2122 Australia

Importowane do USA: Sanven Technology Ltd. Suite 250, 9166 Anaheim Place,
Rancho Cucamonga, CA 91730

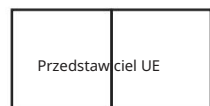

E-CrossStu GmbH
Mainzer Landstr.69, 60329 Frankfurt nad Menem.



YH CONSULTING LIMITED.
C/O YH Consulting Limited Biuro 147, Centurion House,
London Road, Staines-upon-Thames, Surrey, TW18 4AX

Nadal staramy się oferować Państwu narzędzia w konkurencyjnych cenach.
„Oszczędzaj połowę”, „Połowa ceny” lub inne podobne wyrażenia używane przez
nas stanowią jedynie szacunkowe oszczędności, jakie możesz uzyskać, kupując u nas
określone narzędzia w porównaniu z głównymi markami i niekoniecznie oznaczają
one objęcie wszystkich kategorii oferowanych przez nas narzędzi. Uprzejmie
przypominamy, aby przy składaniu zamówienia dokładnie sprawdzić, czy
faktycznie oszczędzasz połowę w porównaniu z głównymi markami.

VEVOR[®]

TOUGH TOOLS, HALF PRICE

Tarcza bębnowa

MODEL: OK-24017

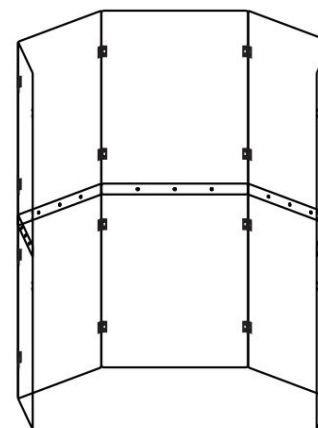





(Zdjęcie ma charakter poglądowy, proszę odnieść się do rzeczywistego obiektu)

POTRZEBUJESZ POMOCY? SKONTAKTUJ SIĘ Z NAMI!

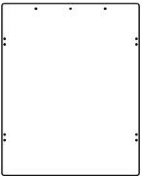
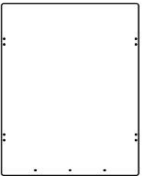
Masz pytania dotyczące produktu? Potrzebujesz wsparcia technicznego? Skontaktuj się z nami:
Wsparcie
techniczne i certyfikat E-Gwarancji www.vevor.com/support

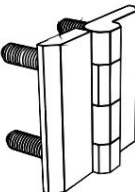
To jest oryginalna instrukcja, przed użyciem należy uważnie przeczytać
wszystkie instrukcje. VEVOR zastrzega sobie jasną interpretację naszej instrukcji
obsługi. Wygląd produktu będzie zależał od produktu, który otrzymałeś. Prosimy
o wybaczenie, że nie poinformujemy Cię ponownie, jeśli w naszym produkcie pojawiają
się jakiegokolwiek aktualizacje technologiczne lub oprogramowania.

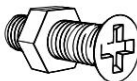
Część	1 A 	2 B 	3 	4 	5 	6 	7 
	Dno bez dziur Dno z dziurami						
	Nazwa	Dolna płyta akrylowa	Górna płyta akrylowa	śrubokręt krzyżakowy	klucz	Zawias	Nakrętka
Ilość	5pcs	5pcs	1pcs	1pcs	16pcs	64pcs	15pcs

Montaż dolnej płyty akrylowej

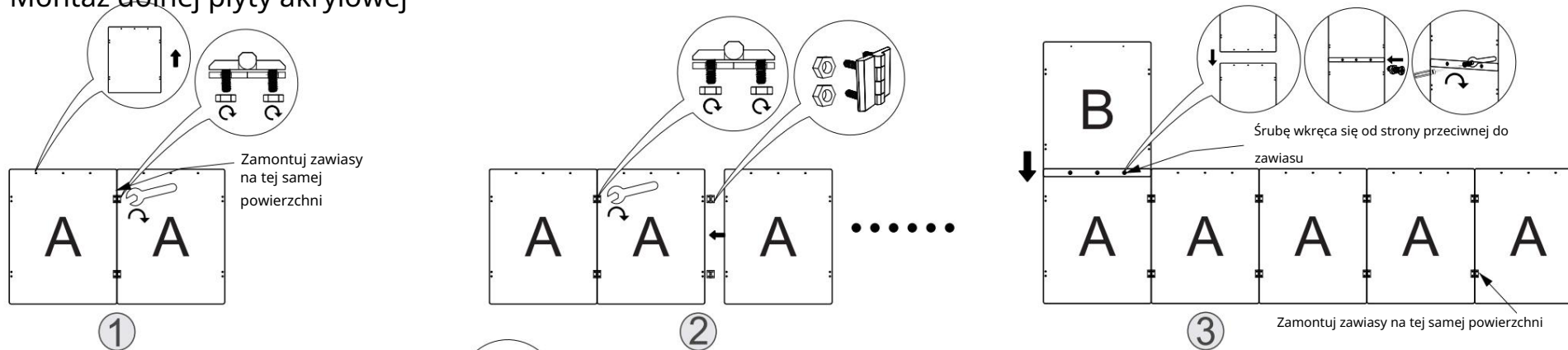

Montaż górnej płyty akrylowej

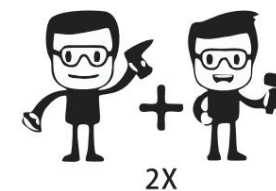
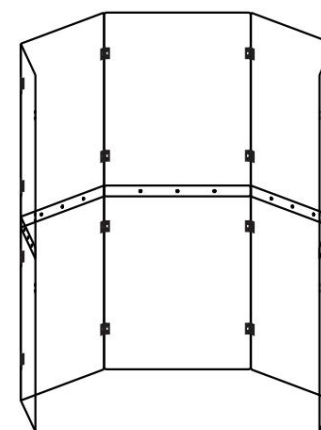
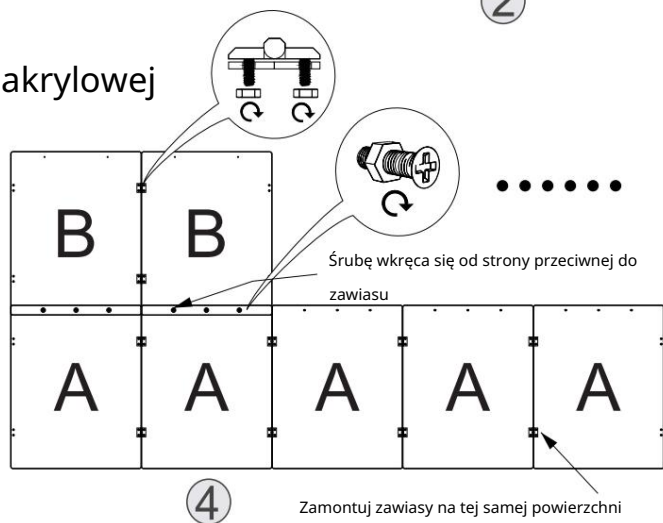

VEVOR®

TOUGH TOOLS, HALF PRICE

Technische ondersteuning en e-garantiecertificaat
www.vevor.com/support

DRUM-SHIELD GEBRUIKERSHANDLEIDING

Fabrikant: Shanghai muxinmuyeyouxiangongsi **Adres:**

Shuangchenglu 803nong11hao1602A-1609shi, baoshanqu, shanghai
200000 CN.

Geïmporteerd naar AUS: SIHAO PTY LTD. 1 ROKEVA STREET EASTWOOD NSW
2122 Australië

Geïmporteerd naar de VS: Sanven Technology Ltd. Suite 250, 9166 Anaheim
Place, Rancho Cucamonga, CA 91730



E-CrossStu GmbH
Mainzer Landstr.69, 60329 Frankfurt am Main.



YH CONSULTING LIMITED.
C/O YH Consulting Limited Kantoor 147, Centurion House,
Londen Road, Staines-upon-Thames, Surrey, TW18 4AX

Wij streven er voortdurend naar om u gereedschappen tegen concurrerende prijzen te leveren. "Save Half", "Half Price" of andere soortgelijke uitdrukkingen die wij gebruiken, geven alleen een schatting weer van de besparingen die u kunt behalen door bepaalde gereedschappen bij ons te kopen in vergelijking met de grote topmerken en betekent niet noodzakelijkerwijs dat alle categorieën gereedschappen die wij aanbieden, worden gedekt. Wij herinneren u eraan om zorgvuldig te controleren of u daadwerkelijk de helft bespaart in vergelijking met de grote topmerken wanneer u een bestelling bij ons plaatst.

VEVOR®

TOUGH TOOLS, HALF PRICE

Trommel-Schild

MODEL: OK-24017

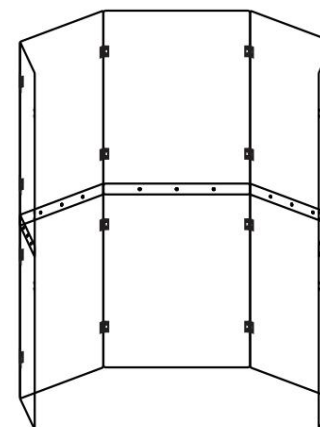







(De afbeelding is alleen ter referentie, kijk naar het daadwerkelijke object)

HULP NODIG? NEEM CONTACT MET ONS OP!

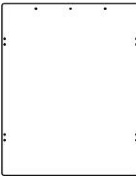
Heeft u vragen over het product? Heeft u technische ondersteuning nodig? Neem dan gerust contact met

ons op: **Technische ondersteuning en E-garantiecertificaat**
www.vevor.com/support

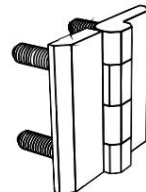
Dit is de originele instructie, lees alle handleidingen zorgvuldig door voordat u het product gebruikt. VEVOR behoudt zich een duidelijke interpretatie van onze gebruikershandleiding voor. Het uiterlijk van het product is afhankelijk van het product dat u hebt ontvangen. Vergeef ons dat we u niet opnieuw zullen informeren als er technologie- of software-updates voor ons product zijn.

Onderdeel	1 A  Bodem zonder gaten	2 B  Bodem met gaten	3 	4 	5 	6 	7 	
	Naam	Onderste acrylplaat	Bovenste acrylplaat	kruisschroevendraaier	moersleutel	Scharnier	Moer	Bouten en moeren
	Hoeveelheid	5pcs	5pcs	1pcs	1pcs	16pcs	64pcs	15pcs

Montage van de onderste acrylplaat

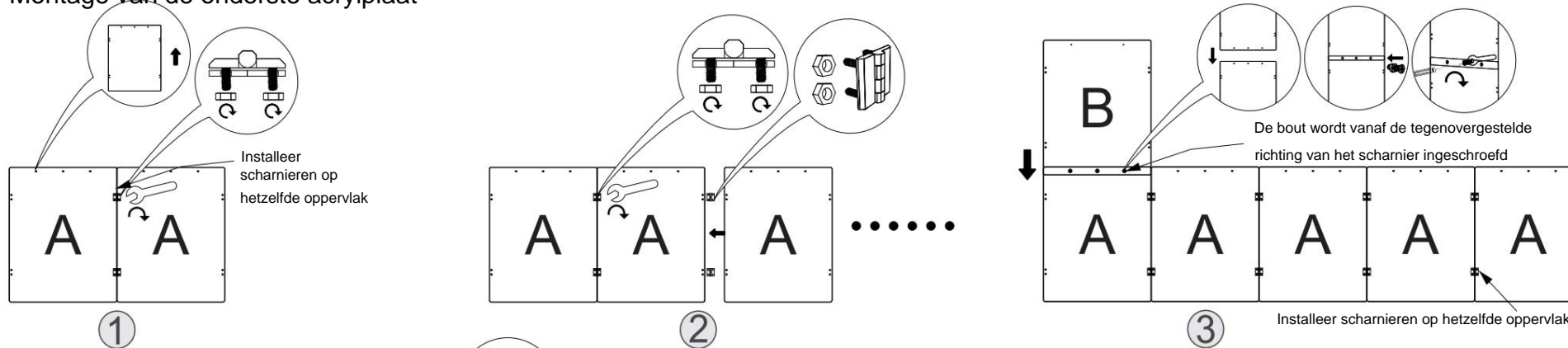

Montage van de bovenste acrylplaat

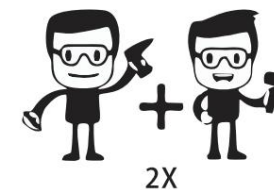
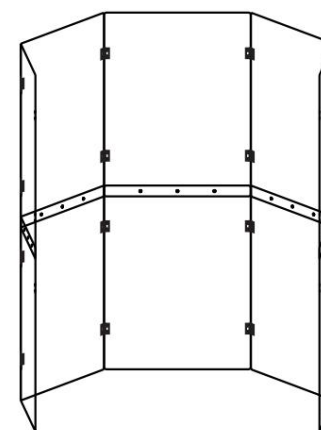
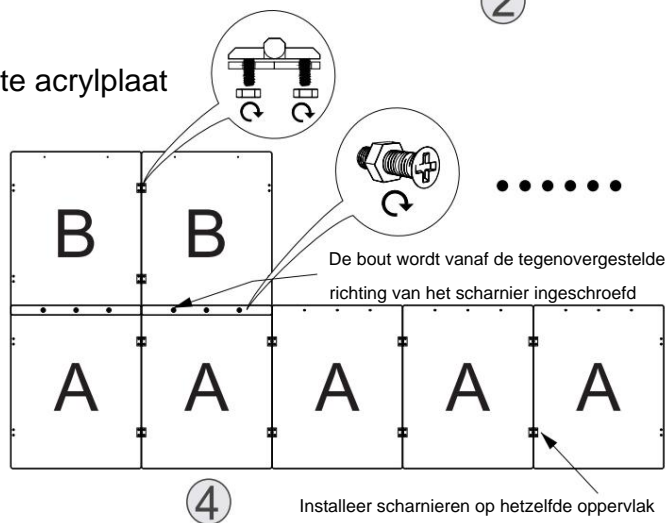

VEVOR[®]

TOUGH TOOLS, HALF PRICE

Teknisk support och e-garanticertifikat
www.vevor.com/support

DRUM-SHIELD ANVÄNDARHANDBOK

Tillverkare: Shanghai muxinmuyeyouxiangongsi

Address: Shuangchenglu 803nong11hao1602A-1609shi, baoshanqu, shanghai 200000 CN.

Importerad till AUS: SIHAO PTY LTD. 1 ROKEVA STREET EASTWOOD NSW 2122 Australien

Importerad till USA: Sanven Technology Ltd. Suite 250, 9166 Anaheim Place, Rancho Cucamonga, CA 91730



E-CrossStu GmbH
Mainzer Landstr.69, 60329 Frankfurt am Main.



YH CONSULTING LIMITED.
C/O YH Consulting Limited Office 147, Centurion House,
London Road, Staines-upon-Thames, Surrey, TW18 4AX

Vi fortsätter att vara engagerade i att ge dig verktyg till konkurrenskraftiga priser. "Spara hälften", "halva priset" eller andra liknande uttryck som används av oss representerar bara en uppskattning av besparingar du kan dra nytta av att köpa vissa verktyg hos oss jämfört med de stora toppmärkena och betyder inte nödvändigtvis att täcka alla kategorier av verktyg som erbjuds av oss. Du påminns om att noggrant kontrollera när du gör en beställning hos oss om du verkligen sparar hälften i jämförelse med de främsta varumärkena.

VEVOR[®]

TOUGH TOOLS, HALF PRICE

Drum-Shield

MODELL: OK-24017

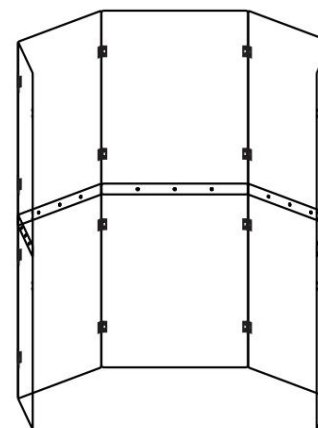





(Bilden är endast för referens, se det faktiska objektet)

BEHÖVER HJÄLP? KONTAKTA OSS!

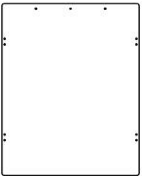
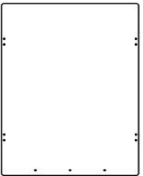
Har du produktfrågor? Behöver du teknisk support? Kontakta oss gärna: **Teknisk support och e-garanticertifikat www.vevor.com/support**

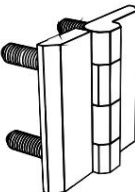
Detta är den ursprungliga instruktionen, läs alla instruktioner noggrant innan du använder den. VEVOR reserverar sig för en tydlig tolkning av vår användarmanual. Utseendet på produkten är beroende av den produkt du fått. Ursäkta oss att vi inte kommer att informera dig igen om det finns någon teknik eller mjukvaruuppdatering på vår produkt.

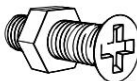
Komponent	1 A 	2 B 	3 	4 	5 	6 	7 
Namn	Nedre akrylplatta	Övre akrylplatta	tvärskruvmejsel	rycka	Gångjärn	Mutter	Bultar och muttrar
Kvantitet	5pcs	5pcs	1pcs	1pcs	16pcs	64pcs	15pcs

Montering av nedre akrylskiva

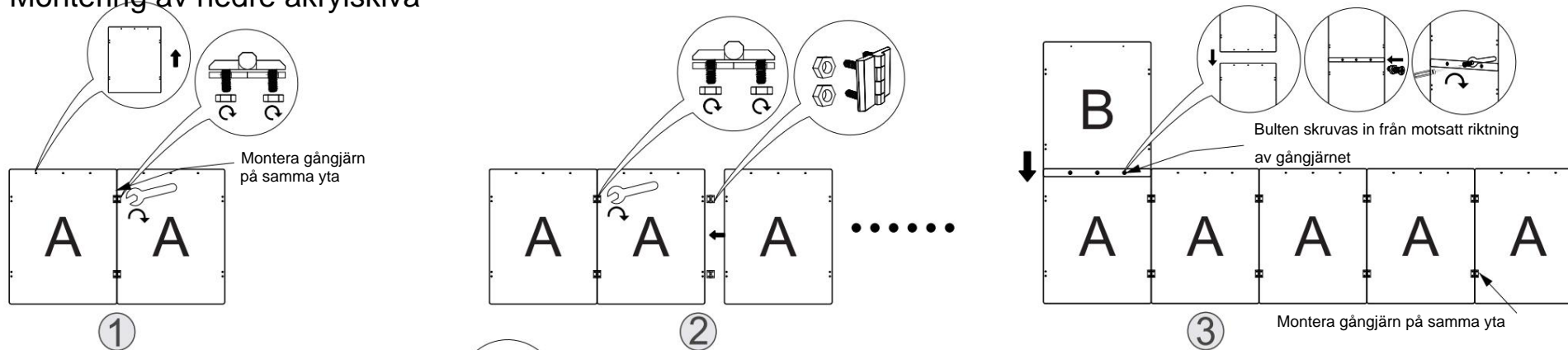

Montering av övre akrylplatta

