

O N K Y O

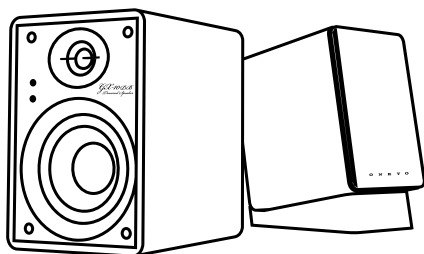

CREATOR SERIES

Instruction Manual

POWERED SPEAKER
GX-10DB

En

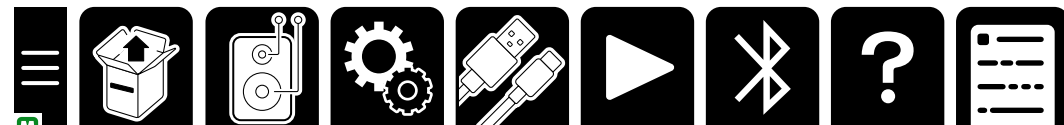

What's in the box	3
Part Names	4
Front Panel	5
Rear Panel	6
Remote Controller	7
Setup	8
Connecting the speaker cable	9
Assembling and connecting the AC adapter	10
Connections	11
Connecting a PC	12
Connecting a TV	13
Connecting a Turntable	14
Connect the Subwoofer	15
Playback	16
Basic Operations	17
Advanced Operations	20
BLUETOOTH® Playback	22
Pairing	22
Playing Back	24
Troubleshooting	25
General Specifications	27
Update Information	29

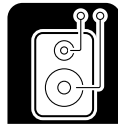

What's in the box

①

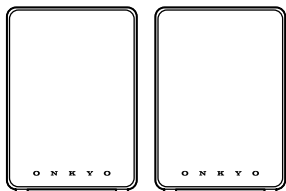

④

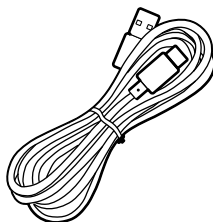

⑥

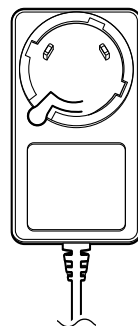

②



⑤

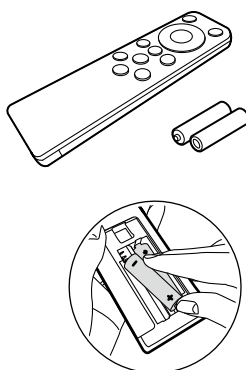

③

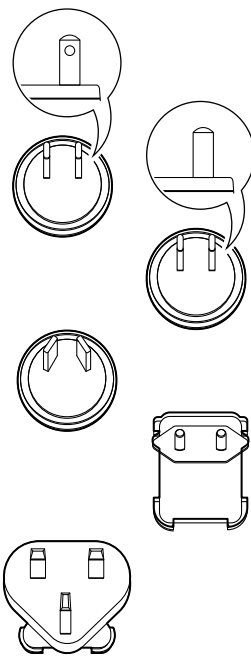
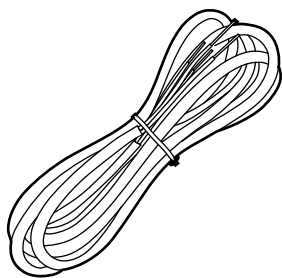

- ① **Speakers (2)**
- ② **Speaker stands (2)**
- ③ **Speaker cable (1)**
- ④ **USB cable (1)**
- ⑤ **Remote controller (RC-992S) (1)**
*Batteries (AAA/R03) (2)
- ⑥ **AC adapter and plug adapter**
 - Initial Setup Guide (1)
 - Safety Information (1)
 - Warranty: For North America (1) and Europe (1)

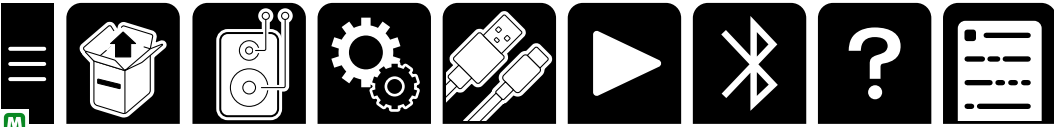

Front Panel	5
Rear Panel	6
Remote Controller	7

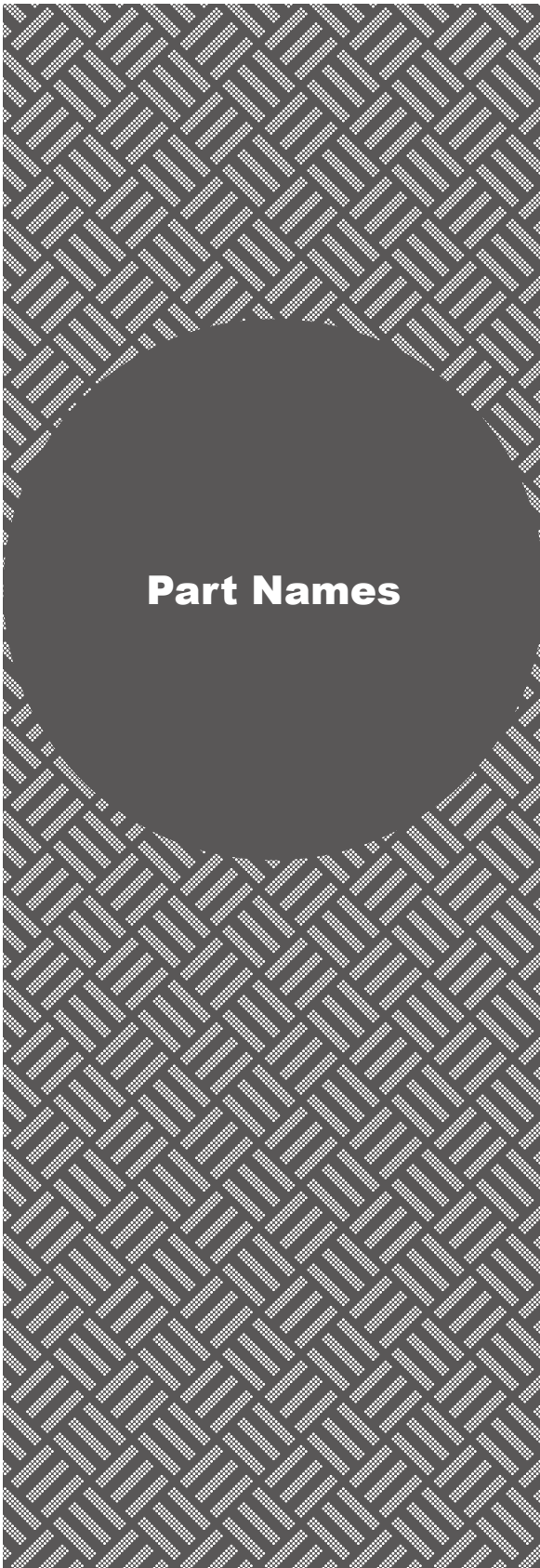

Part Names

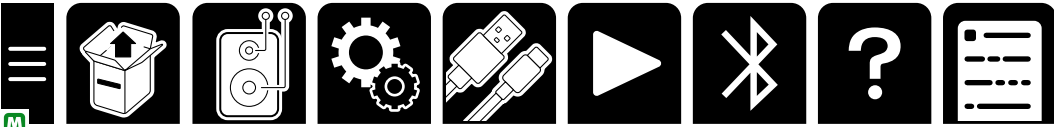

Front Panel

LEFT
SPEAKER

RIGHT
SPEAKER

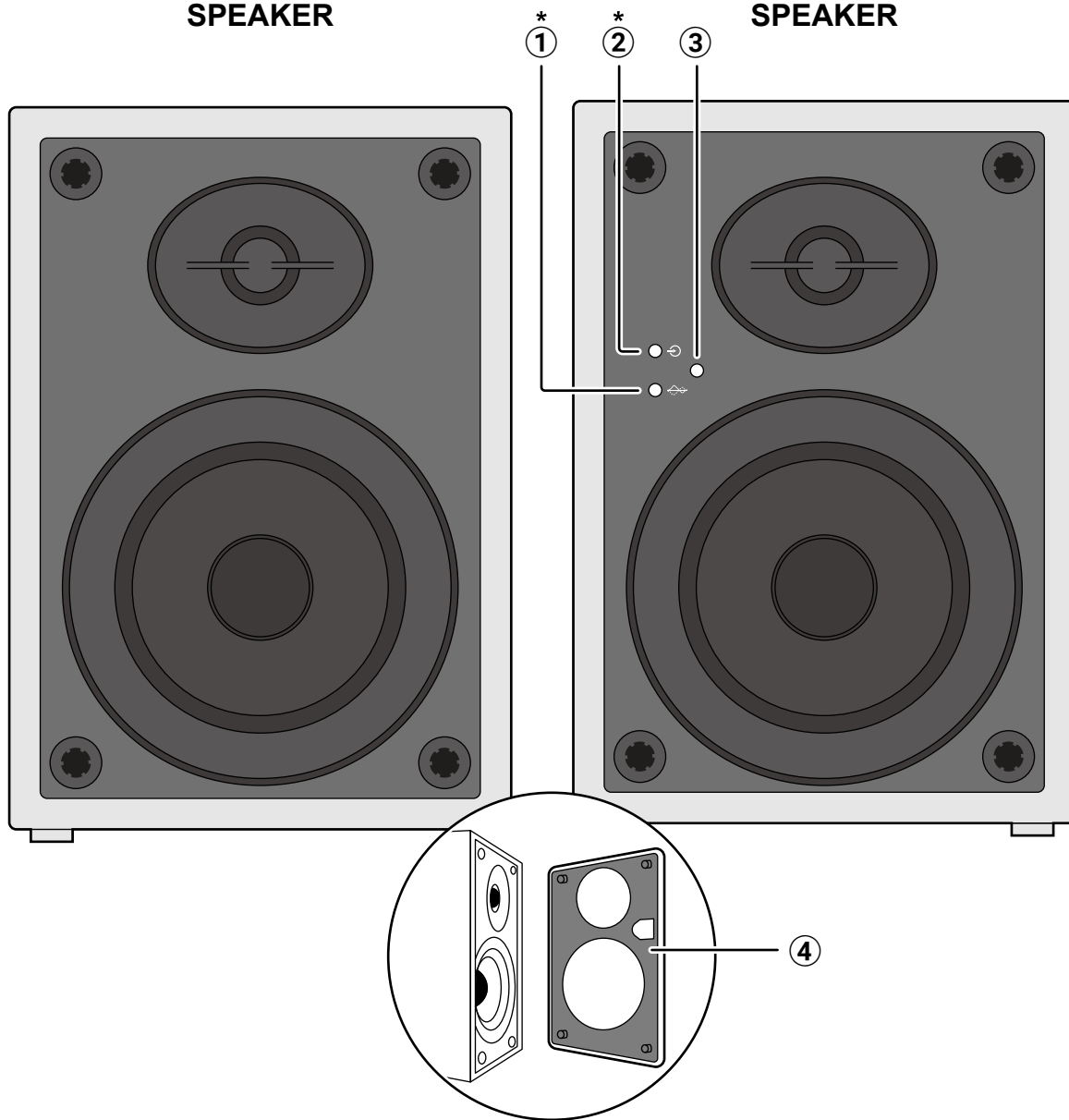

- ① LED Flat sound mode Indicator (→p20)
- ② LED Source Indicator (→p18)
- ③ Remote control sensor
- ④ Speaker grill

*Auto Dimmer function

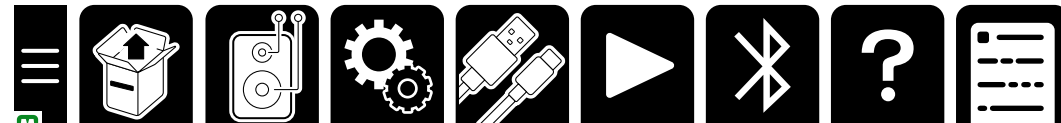
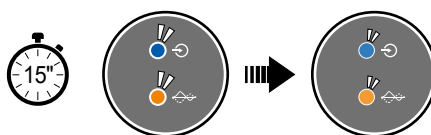

Rear Panel

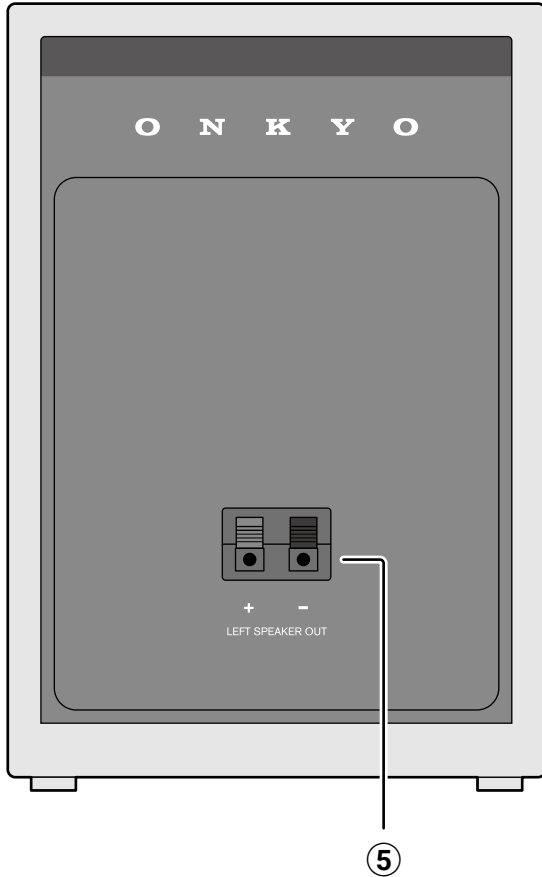
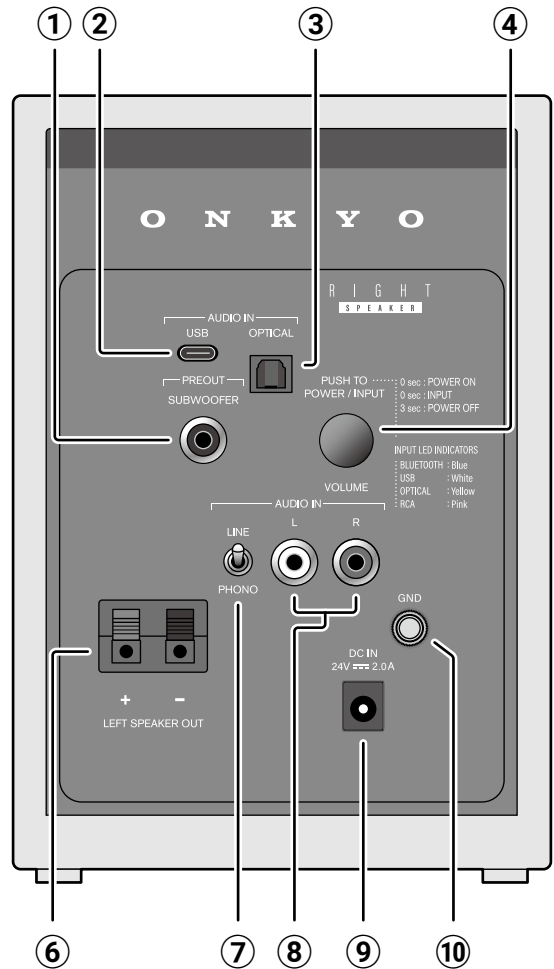
LEFT
SPEAKERRIGHT
SPEAKER

- ① PREOUT SUBWOOFER terminal (→[p15](#))
- ② USB Type-C terminal (→[p12](#))
- ③ Optical digital input terminal (→[p13](#))
- ④ POWER/INPUT switch
VOLUME dial
- ⑤ Speaker terminal(LEFT SPEAKER) (→[p9](#))
- ⑥ Speaker terminal(RIGHT SPEAKER) (→[p9](#))
- ⑦ LINE/PHONO selector switch
- ⑧ AUDIO IN LR terminals (RCA stereo terminals) (→[p14](#))
- ⑨ DC IN terminal
- ⑩ GND terminal (→[p14](#))

Remote Controller

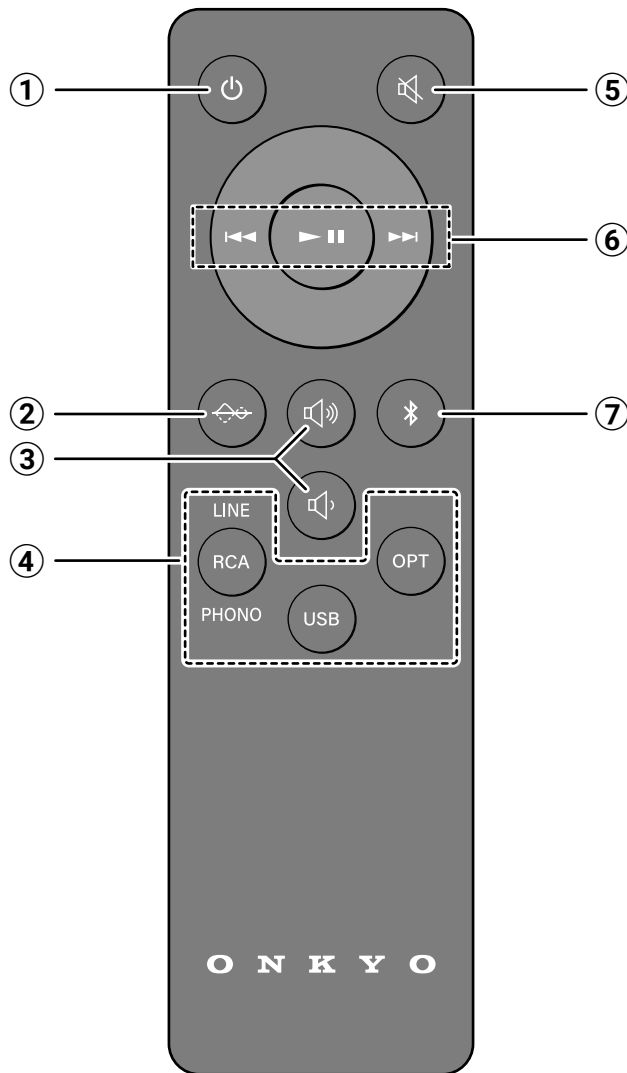

- ① ON/STANDBY button
- ② Flat sound mode button (→ [p20](#))
- ③ Volume UP/DOWN buttons
- ④ input selector buttons (→ [p18](#))
- ⑤ Mute button
- ⑥ Play operation buttons
- ⑦ BLUETOOTH® button (→ [p22](#))

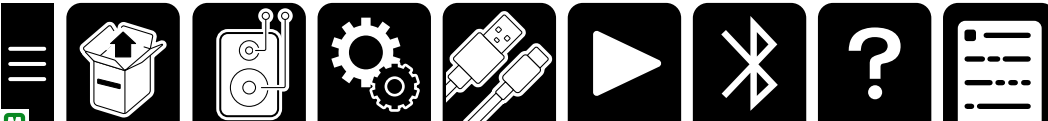

Connecting the speaker cable	9
Assembling and connecting the AC adapter	10

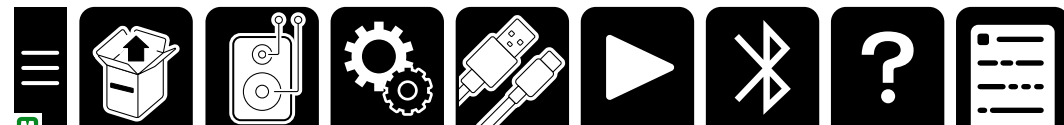
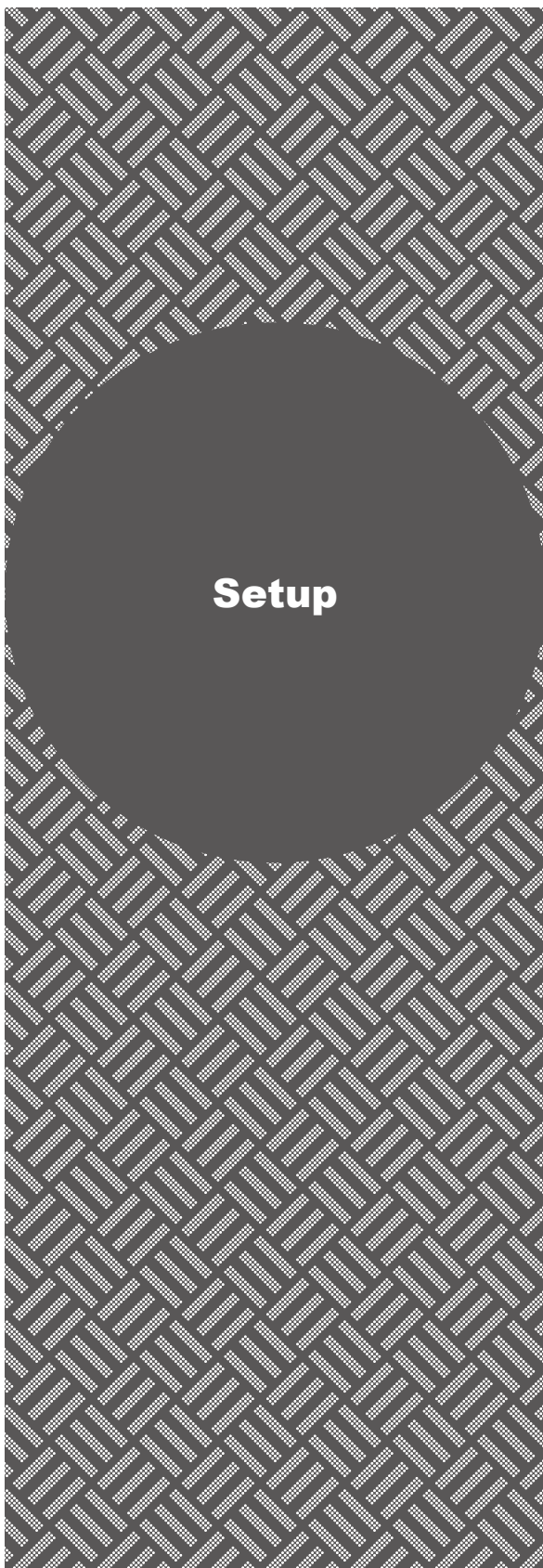

Connecting the speaker cable

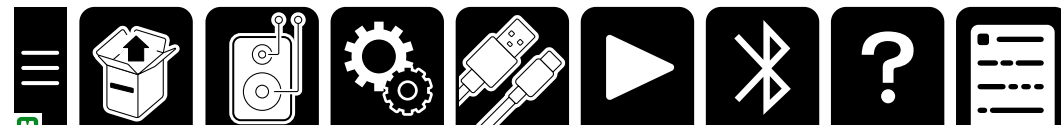
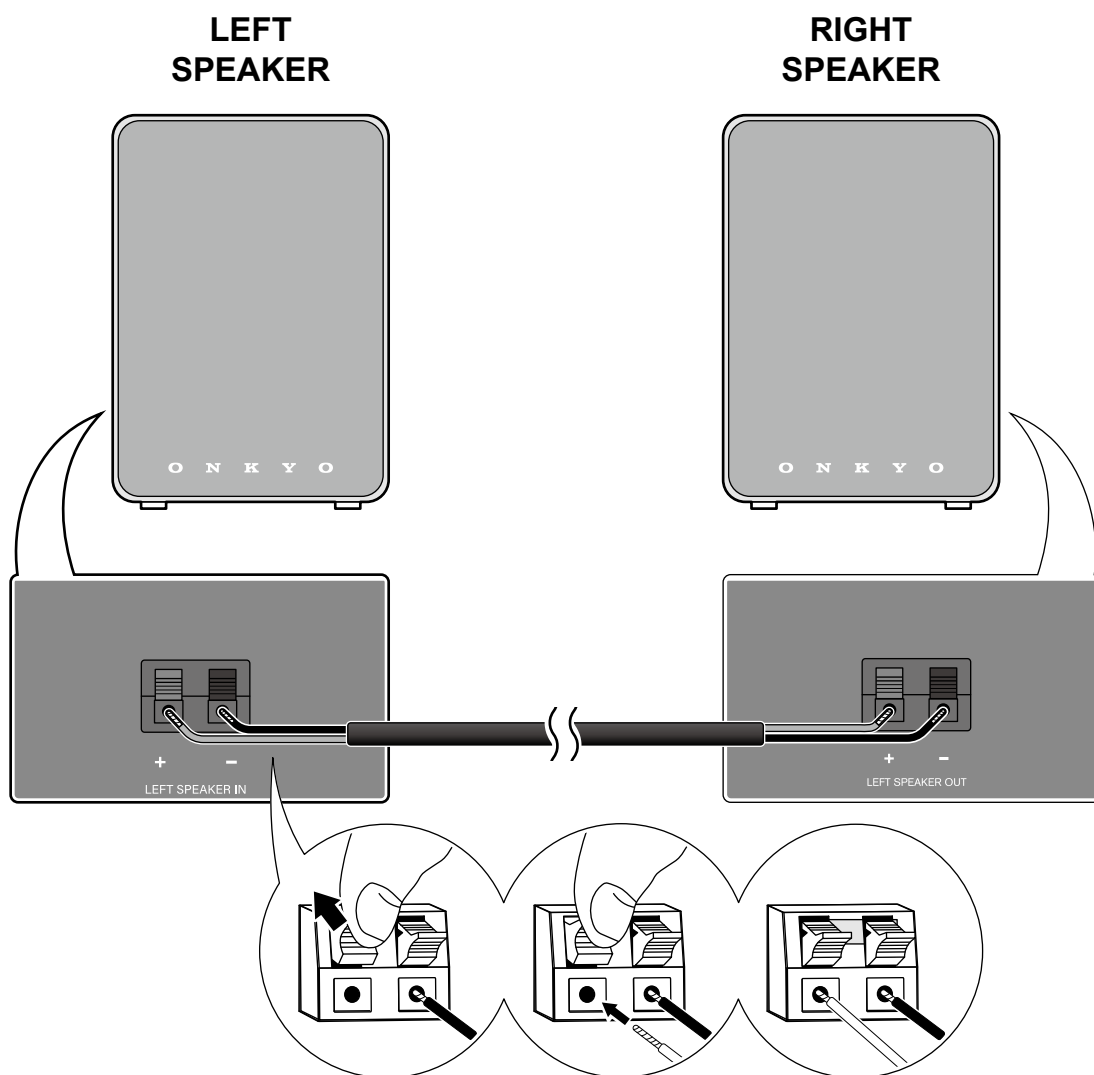

Assembling and connecting the AC adapter

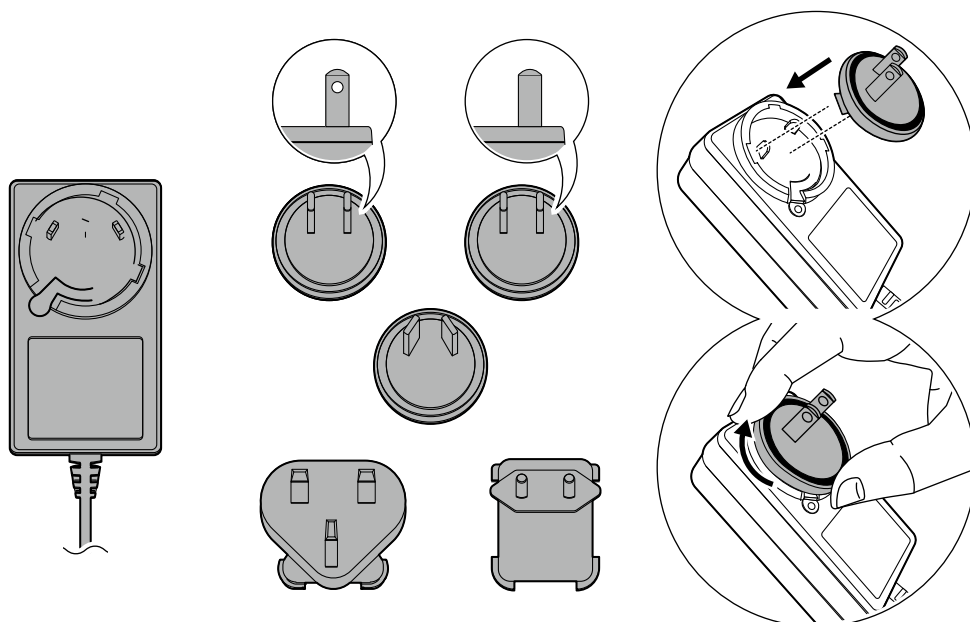
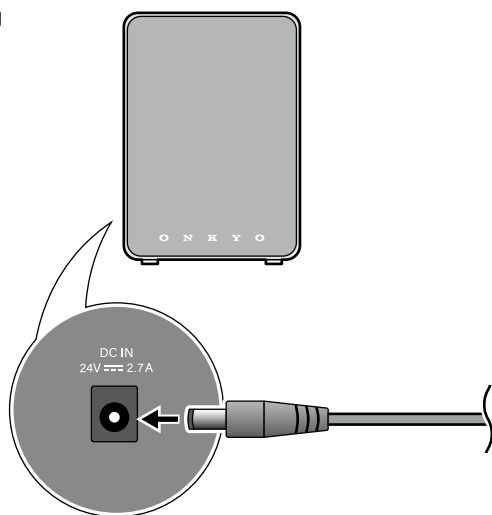
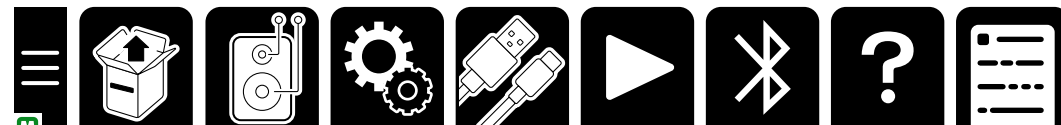
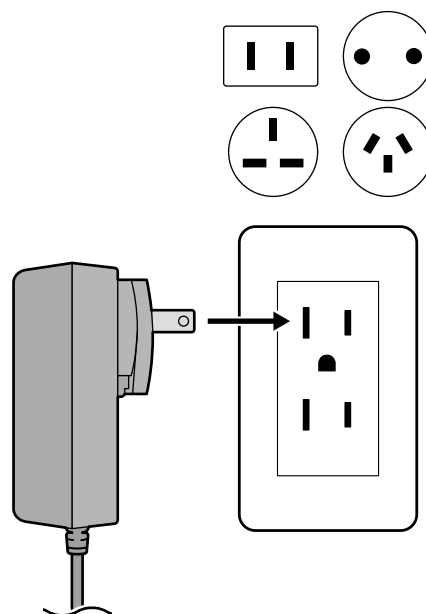
1**2****3**

Connecting a PC	12
Connecting a TV	13
Connecting a Turntable	14
Connect the Subwoofer	15



Connections

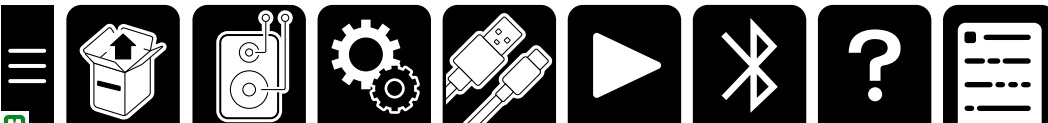

Connecting a PC

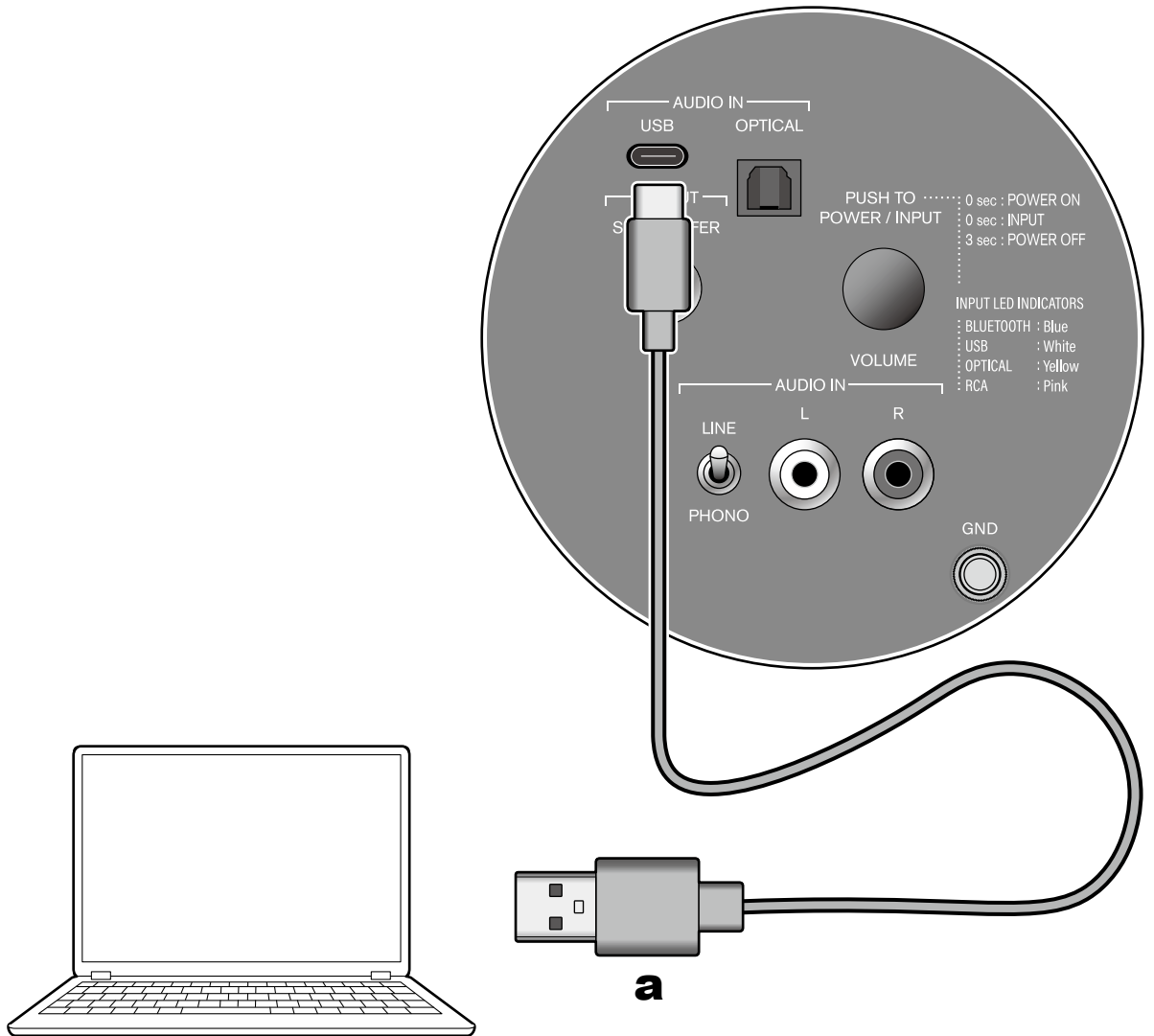

a USB cable

Connection location

This unit: AUDIO IN USB terminal (USB Type-C terminal)

Tips

Supported OS: Windows10 or later

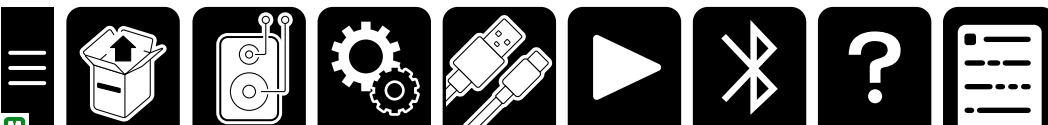

Connecting a TV

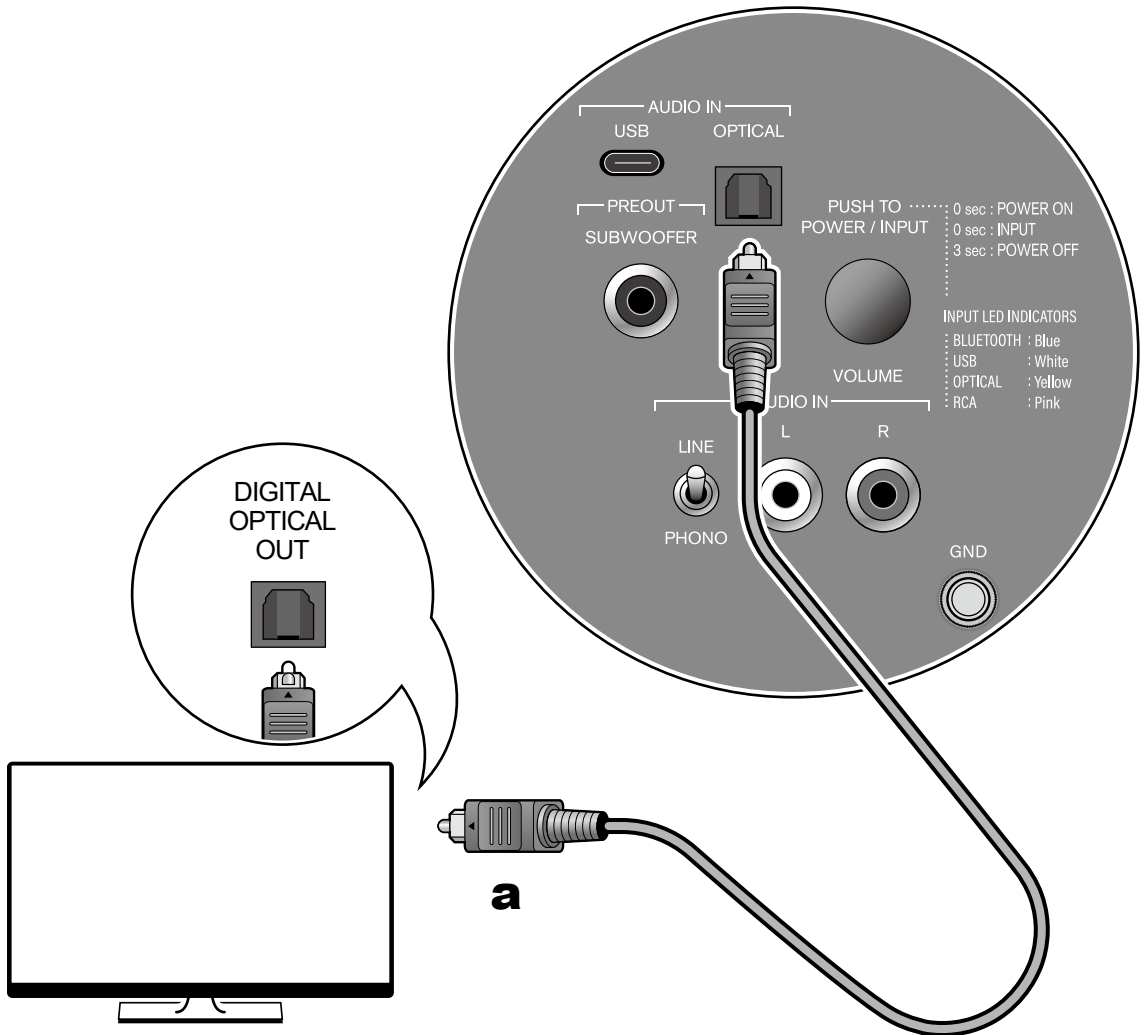

a Digital optical cable

Connection location

This unit: AUDIO IN OPTICAL terminal
 TV: Optical digital output terminal

Tips

The AUDIO IN OPTICAL terminal of this unit supports 2-ch PCM signals only. Set the digital audio output setting of the TV to "PCM".

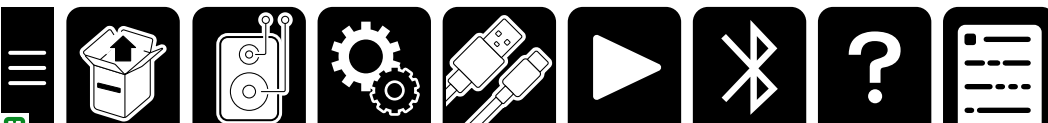

Connecting a Turntable

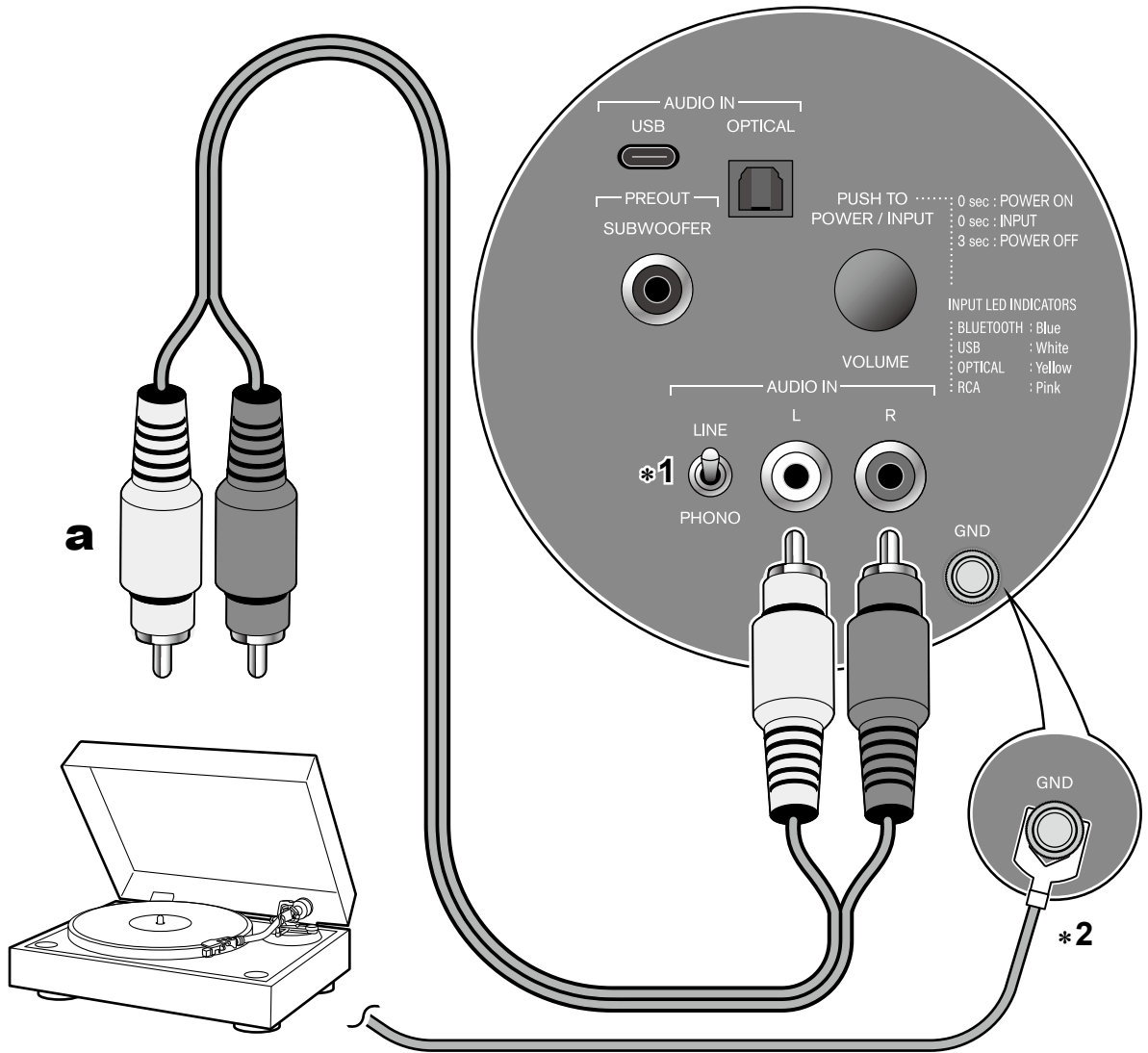

a Analog audio cable

Connection location

This unit: AUDIO IN LR terminals (RCA stereo terminals)

*1 When connecting a turntable that does not have a built-in phono equalizer, set the LINE/PHONO selector switch to "PHONO".

*2 When the turntable has a ground wire, connect it to the GND terminal.

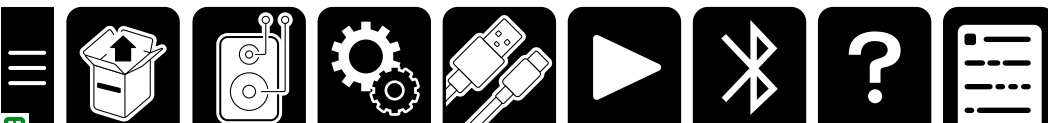

Connect the Subwoofer

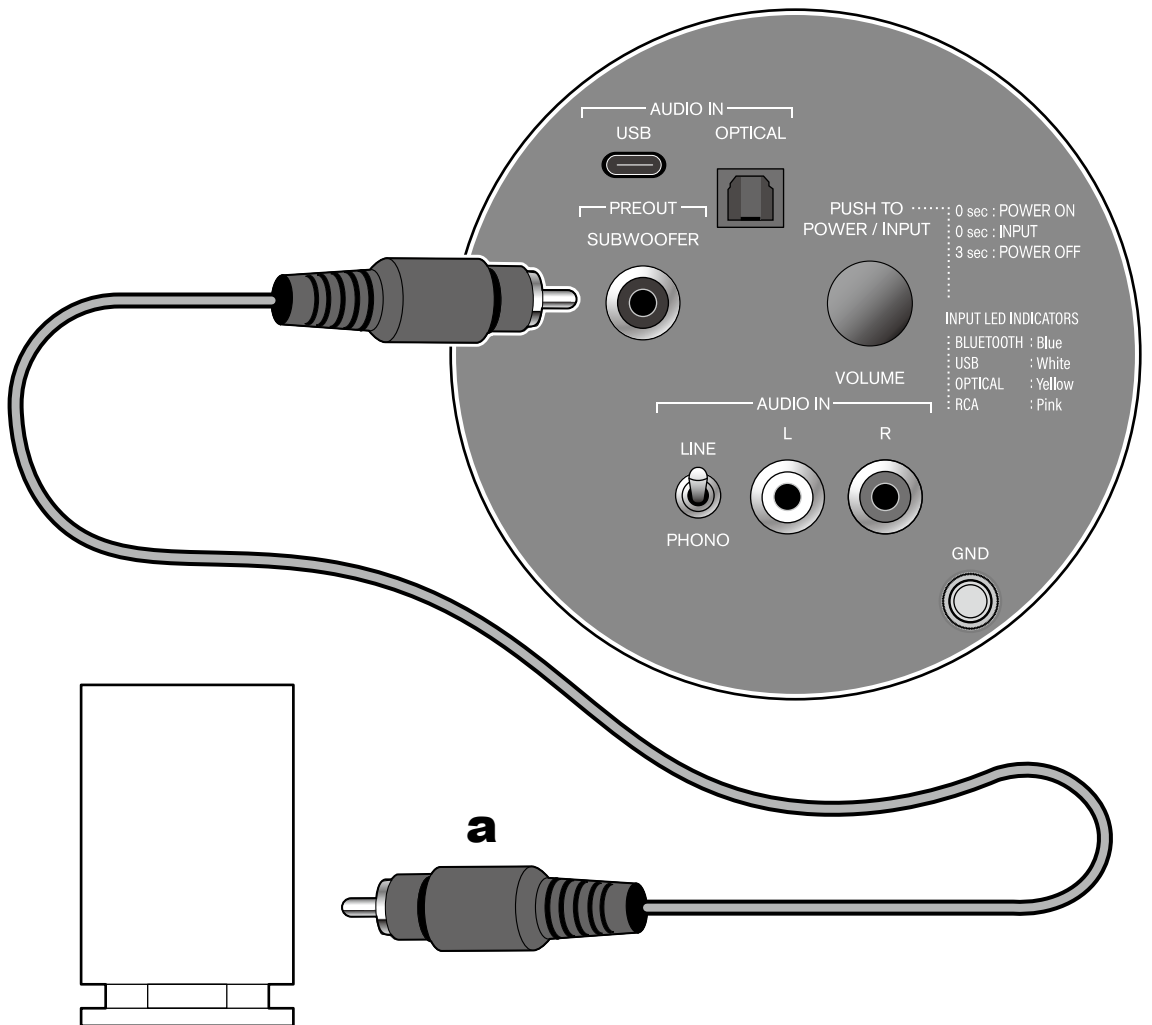

a Subwoofer cable

Connection location

This unit: PREOUT SUBWOOFER terminal (RCA monaural terminal)

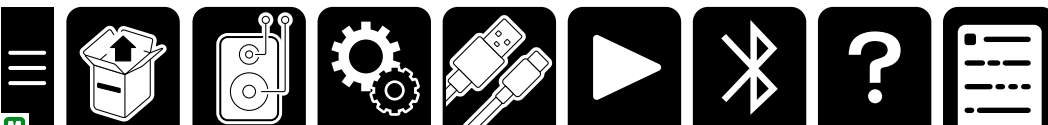

Basic Operations	17
Advanced Operations	20
BLUETOOTH® Playback	22

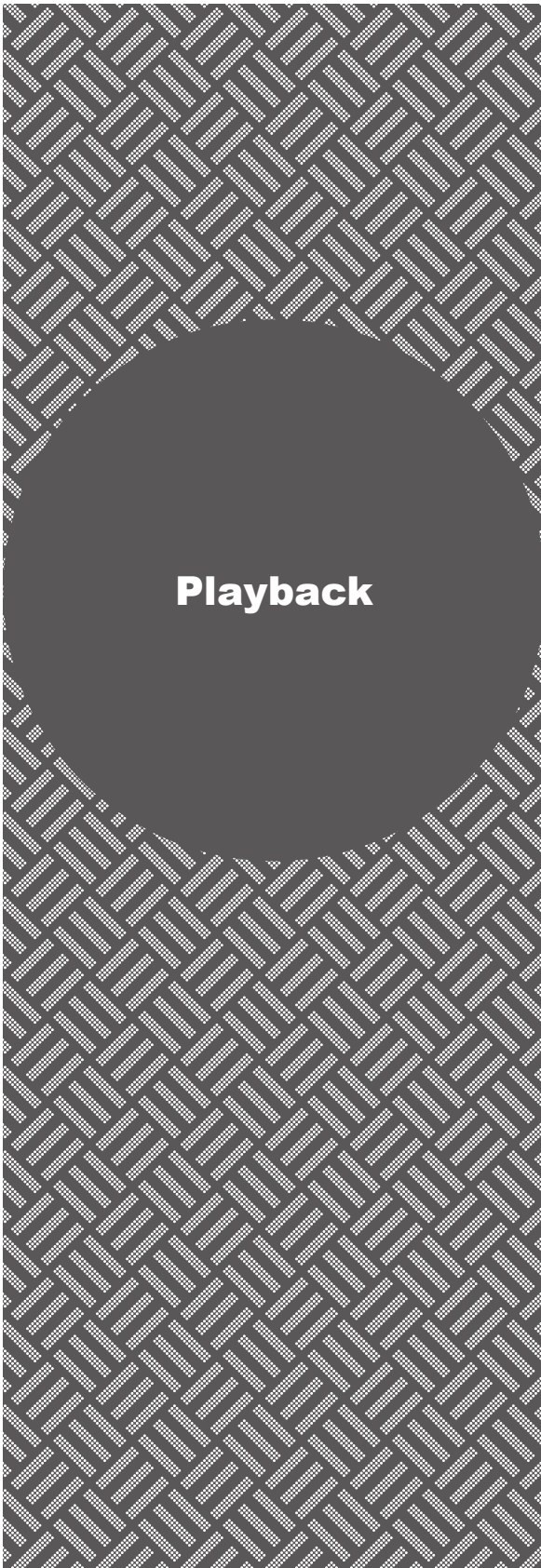

Playback

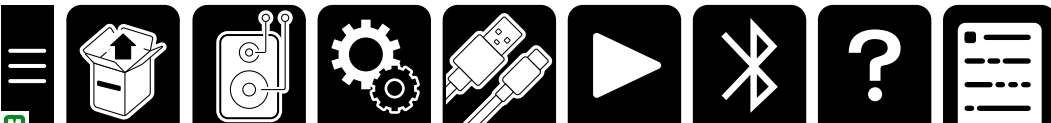

Basic Operations

■ On/Standby

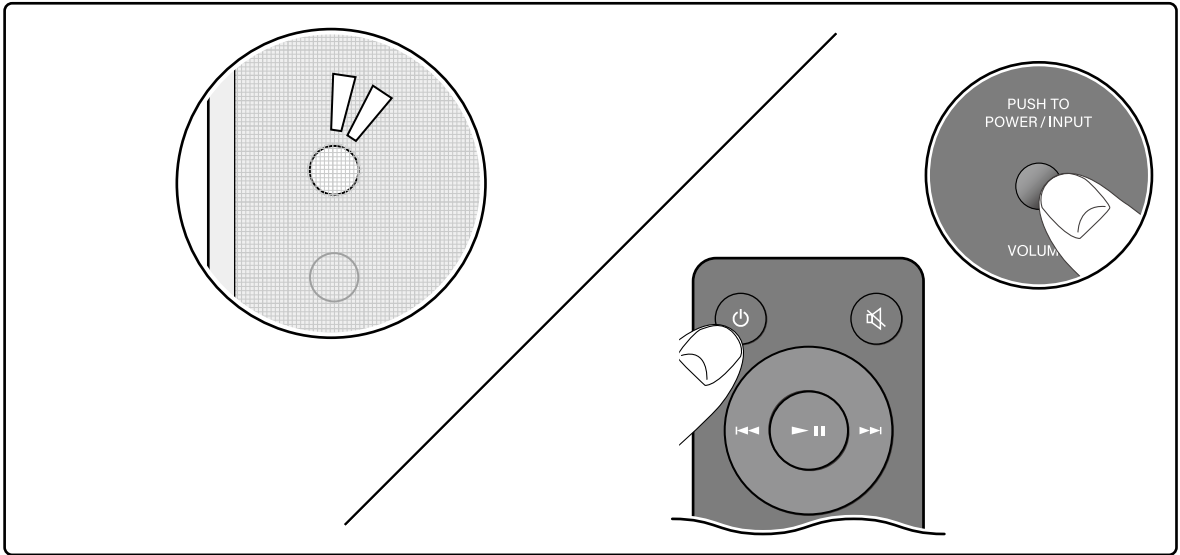

When operating with the remote controller

Press the ON/STANDBY button.

When operating with the main unit

On : Press the POWER/INPUT switch.

Standby : Press and hold the POWER/INPUT switch for three seconds.

Tips

When no signal is detected for 15 minutes or longer, the unit automatically enters the standby mode.

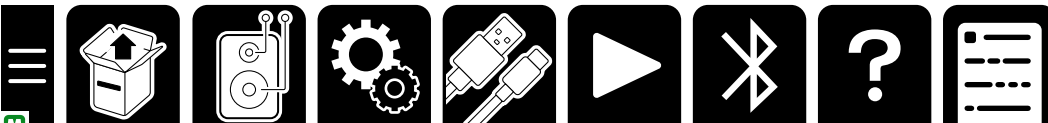

■ Switching the input source

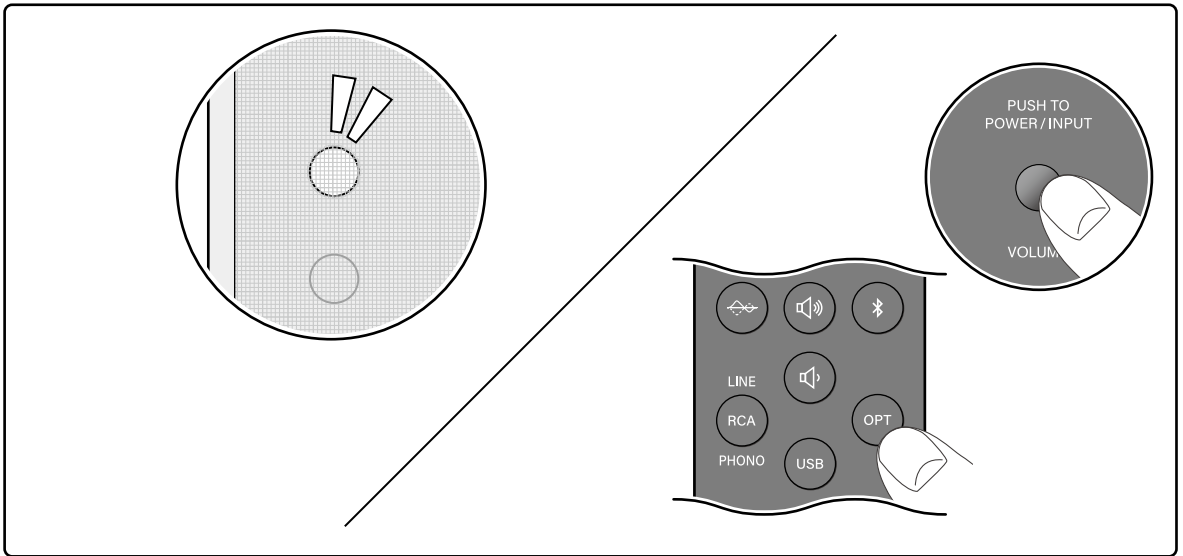

When operating with the remote controller

Press any of the input selector buttons.

When operating with the main unit

Press the POWER/INPUT switch repeatedly.

The color of the LED Source Indicator changes depending on the selected input source.

BLUETOOTH : Blue
 USB : White
 OPTICAL : Yellow
 RCA : Pink

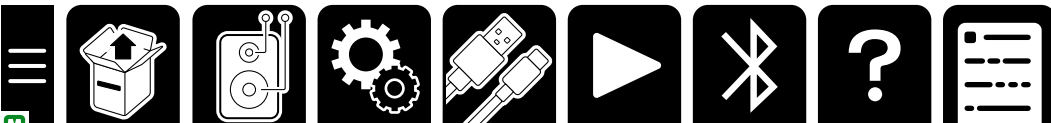

■ Adjusting the volume

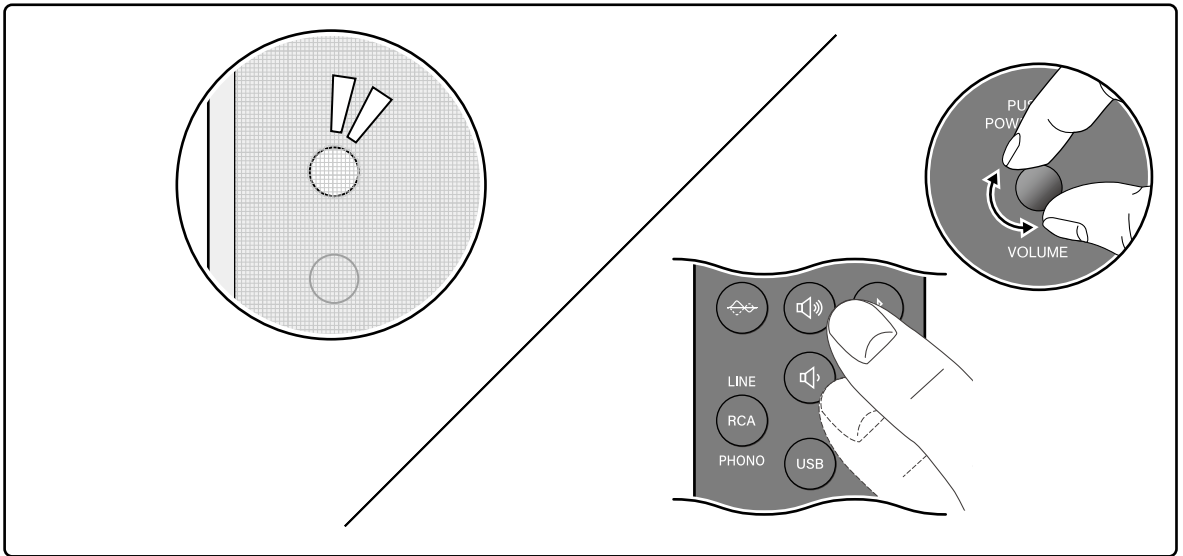

When operating with the remote controller

Press the Volume UP/DOWN buttons.

When operating with the main unit

Turn the VOLUME dial.

■ Mute

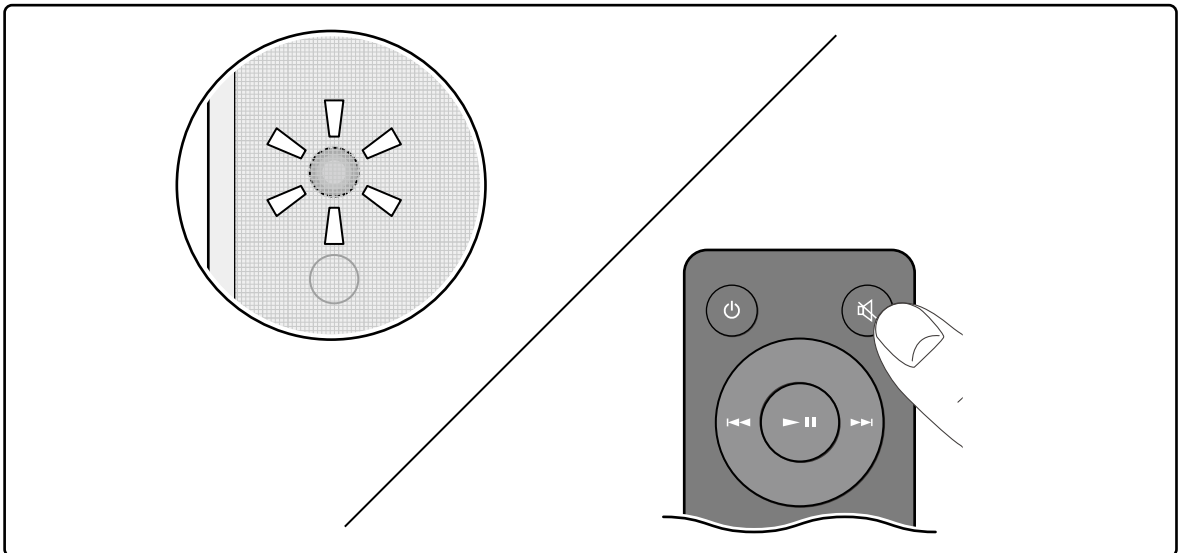

Press the Mute button.

In the mute state, the LED Source Indicator blinks in red.

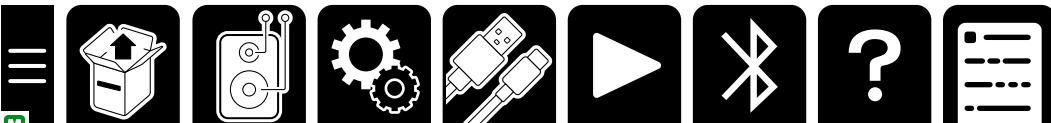

Advanced Operations

■ Setting the flat sound mode to On/Off

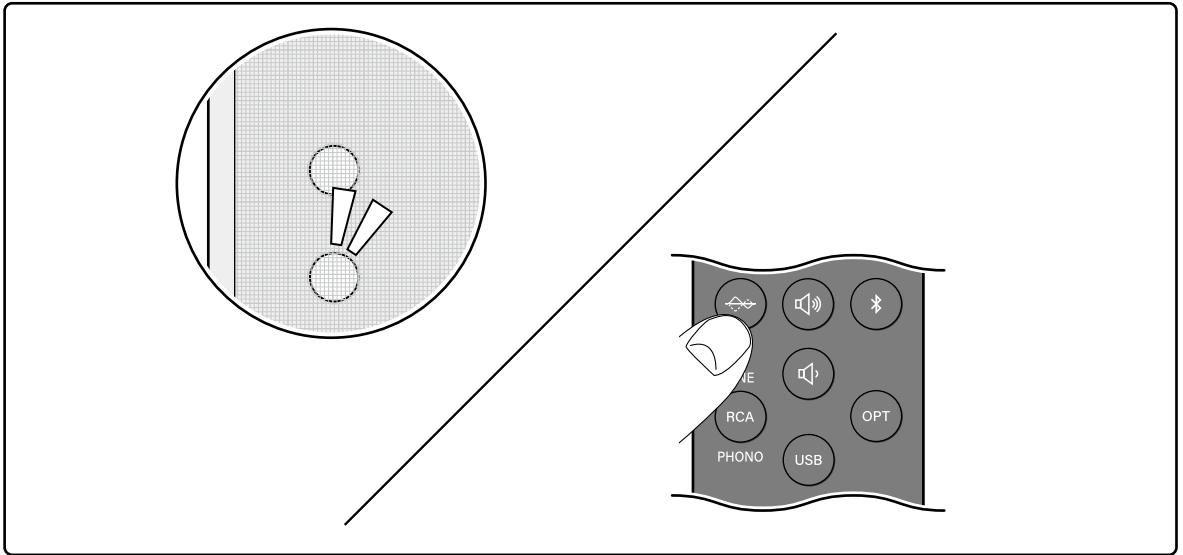

Off (default) : Bass and treble are enhanced to reproduce sound with inflection.
On : Flat sound is reproduced without enhancing bass and treble.

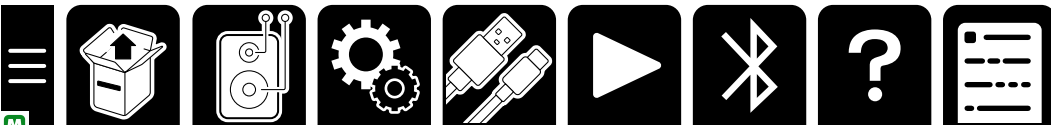

■ Auto Standby

This setting allows the unit to enter standby mode automatically after 15 minutes of inactivity without any audio input.

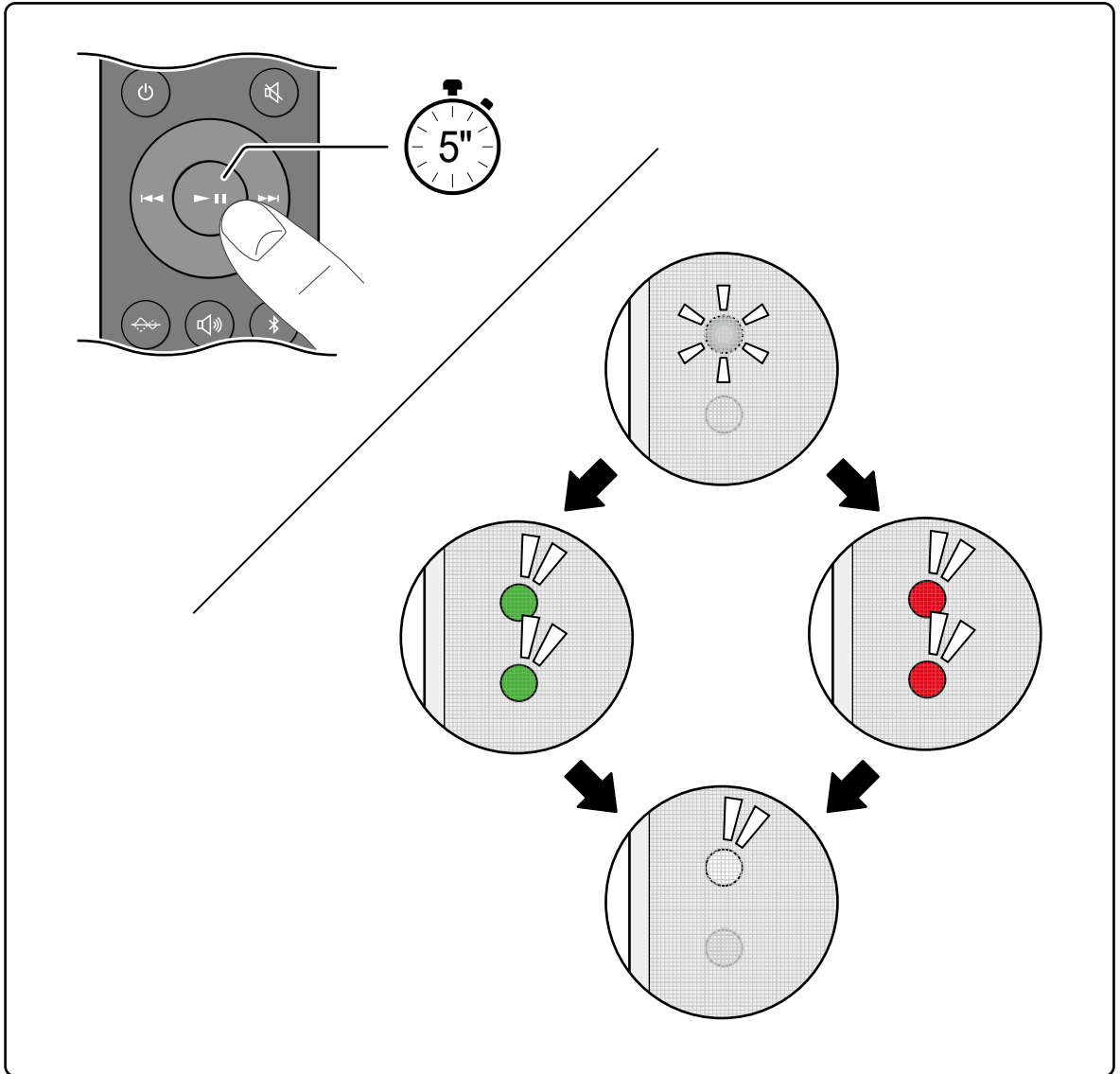

Green : On (default)
 Red : Off

Tips

- About the Auto Standby Function : When set to off, power consumption increases as the power continues to turn on.

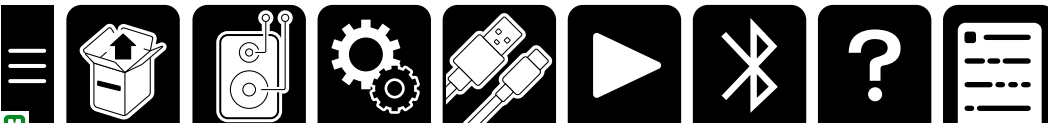

BLUETOOTH® Playback

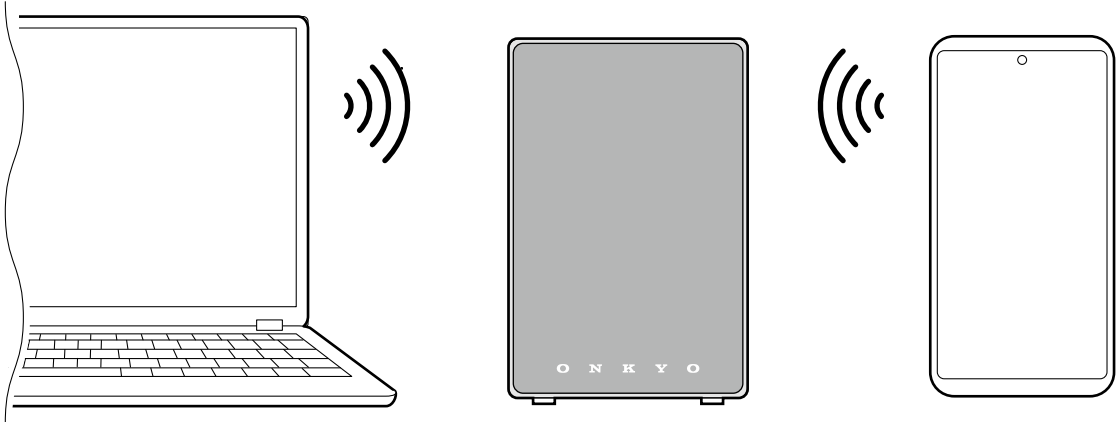

Pairing

1. Press the ON/STANDBY button to turn on the unit.

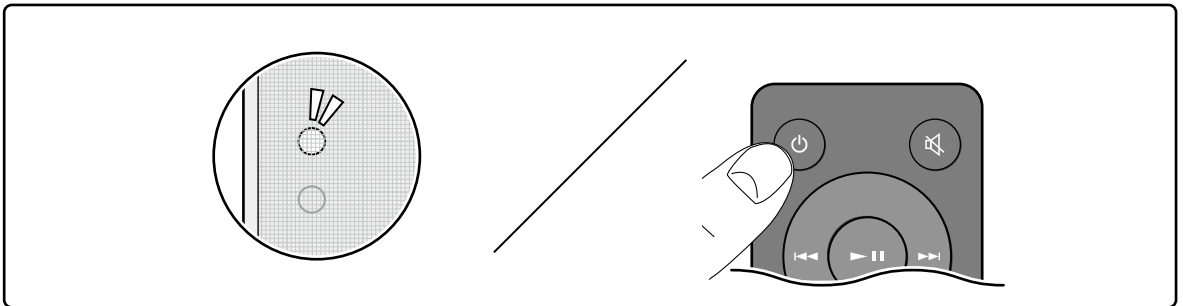

2. Press the BLUETOOTH button.

The LED Source Indicator blinks in blue, which shows the unit has entered the pairing standby mode.

- When a BLUETOOTH-supported device has already been connected, cancel the connection, or press and hold the BLUETOOTH button of the remote controller for three seconds. Then the unit enters the pairing standby mode again.

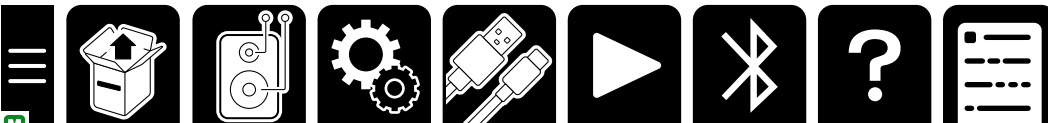
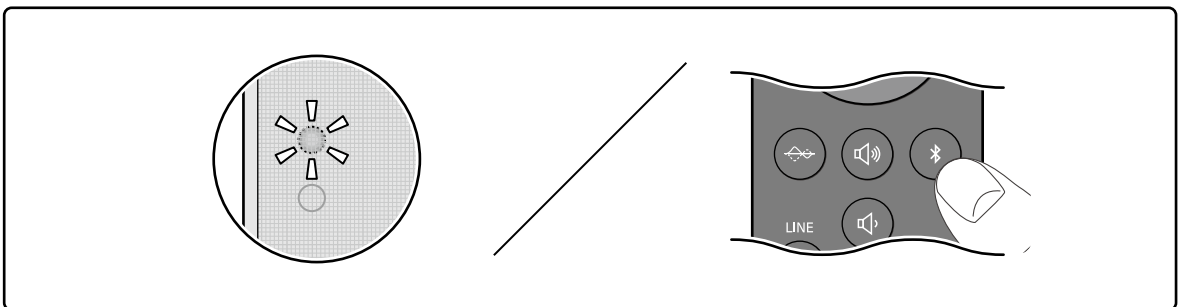

3. Turn on the BLUETOOTH function of the BLUETOOTH-supported device.

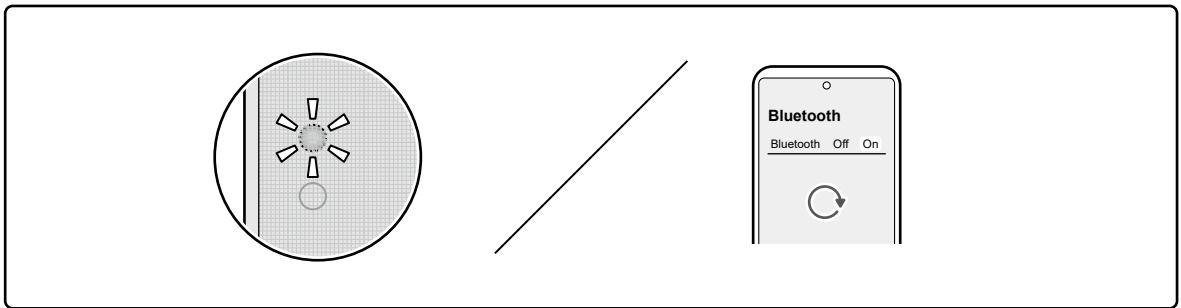

4. Operate the BLUETOOTH-supported device, and select this unit.

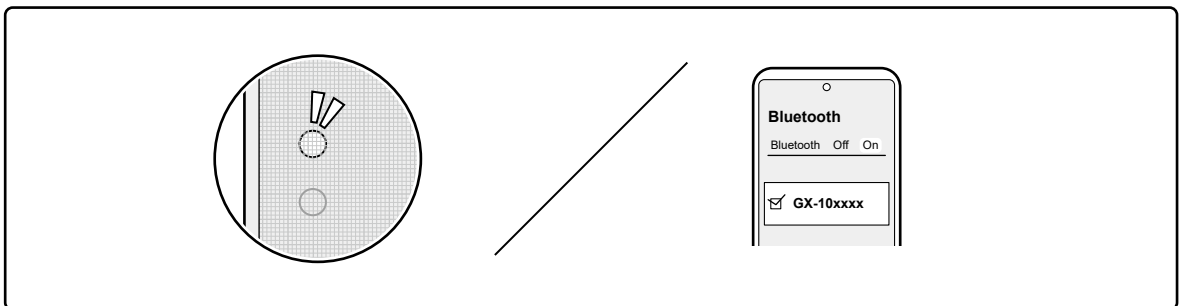

- When connecting multiple BLUETOOTH-supported devices, cancel the current connection, or press and hold the BLUETOOTH button of the remote controller for three seconds to let the unit enter the pairing standby mode. Then turn on the BLUETOOTH function of the next device.
- This unit can store the pairing information of up to 8 paired devices.

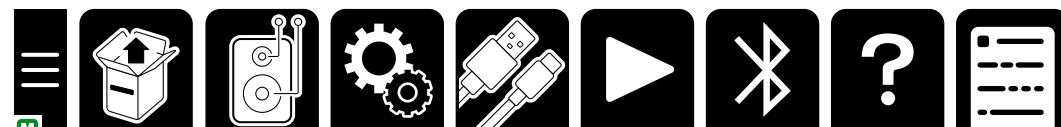

Playing Back

1. Press the ON/STANDBY button to turn on the unit.

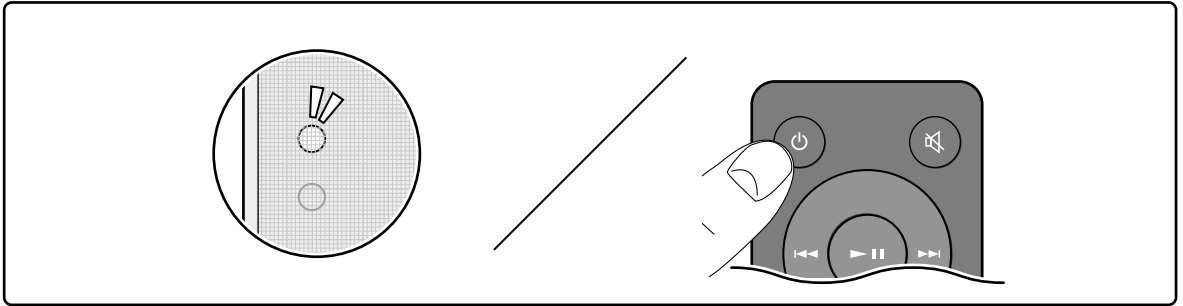

2. Press the BLUETOOTH button.

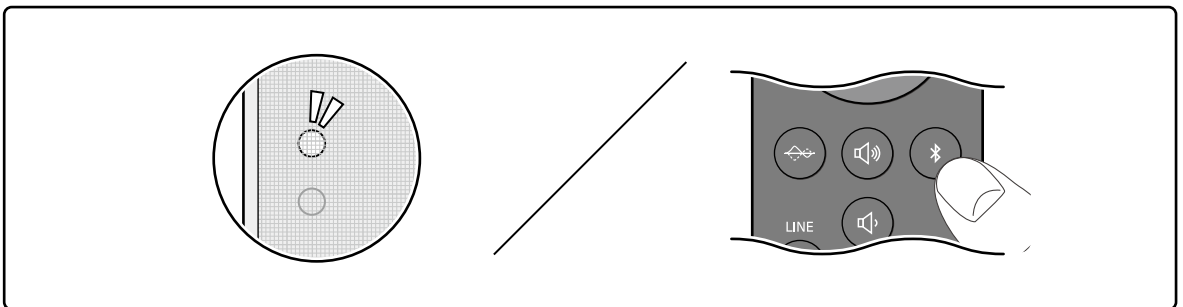

3. Operate the BLUETOOTH-supported device, and play music.

Tips

- The unit automatically turns on by operating the BLUETOOTH-supported device in standby mode to play music, etc.
- When no signal is detected for 15 minutes or longer, the unit automatically enters the standby mode.

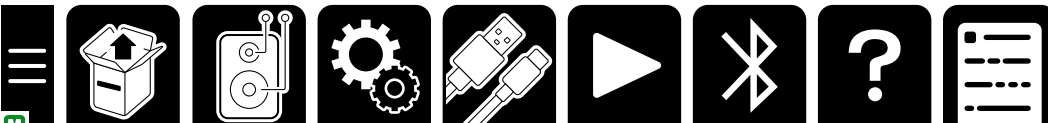

Troubleshooting

❑ Resetting the unit

Turn on the unit. While pressing down the POWER/INPUT switch on the rear panel, press and hold the Mute button on the remote controller.

The LED Source Indicator turns off, and turns on again. Then resetting is complete.

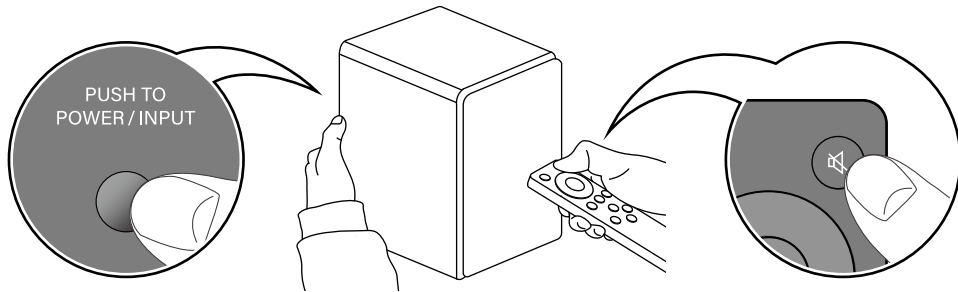

❑ Failure judgment: The LED Source Indicator lights up in red, and the unit does not turn on.

The protection circuit may be functioning.

According to the following procedure, restart the unit, and reconnect the cable.

1. Remove the AC adapter from the unit, and wait at least 10 minutes.
2. Remove the speaker cable connecting the right and left speakers, and reconnect it.
3. Reconnect the AC adapter.
4. Press the ON/STANDBY button, and check if the unit turns on.
When the unit does not turn on or the LED lights up in red again, the unit may be malfunctioning.

❑ Failure judgment: No sound is reproduced from the right or left speaker.

– When the external device has been connected to this unit with an analog cable, contact failure or disconnection of the cable may have occurred. Reconnect the cable or replace the cable with another one to see how it works.

When the external device has been connected to this unit with a digital cable, check the audio output setting of the external device.

❑ Failure judgment: Pairing with a BLUETOOTH-supported device cannot be established.

According to the following procedure, delete the information of the BLUETOOTH-supported device, and perform pairing again.

1. Turn on the unit, and press and hold the BLUETOOTH button on the remote controller at least 10 seconds. Pressing and holding the button for 10 seconds or longer will delete the information of the BLUETOOTH-supported device stored in the unit.
2. Open the setting screen of the BLUETOOTH-supported device (smartphone, PC, etc.), and delete the information of this unit (device name) that has been registered.

*For more information, refer to the instruction manual of the BLUETOOTH-supported device.

Repairing

1. Turn on the unit, and press the BLUETOOTH button on the remote controller.
2. Confirm that the LED Source Indicator blinks in blue. Then operate the BLUETOOTH-supported device, and perform pairing again.
3. When the pairing is successful and the LED Source Indicator lights up, play music, etc. to check if the sound is reproduced.

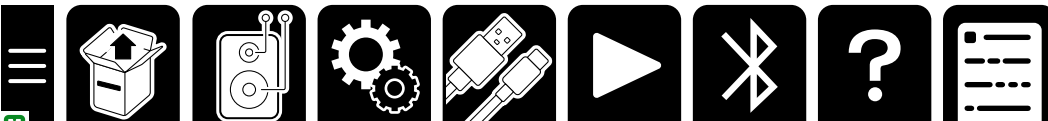

❑ Failure judgment: No sound is reproduced from PC.

When the PC is connected using a USB cable

According to the following procedure, confirm the PC settings.

1. While this unit is connected, right-click the speaker symbol at the bottom right of the PC screen, and select "Sound setting".
2. Select "Output" - "Choose where to play sound" and set this unit.
If no sound is reproduced even after the setting is complete, or if this unit is not displayed on the setting screen, change the connection location of the USB terminal, and see how it works.
If no sound is reproduced even after the connection location is changed, the unit may be malfunctioning.

❑ Failure judgment: No sound is reproduced from TV.

Check if the digital audio output setting of the TV is set to "PCM".

This unit supports PCM signals. It does not support Dolby Digital or AAC.

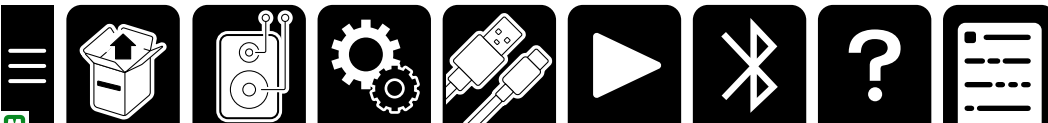

General Specifications

■Type

RIGHT SPEAKER:2-way bass reflex type with built-in amplifier, detachable speaker grill

LEFT SPEAKER:2-way bass reflex type, detachable speaker grill

■Speakers used

Woofer : 3inch(76.2 mm) , Tweeter : 3/4inch (19 mm)

■Amplifier configurations

2ch

■Power Output

17W×2ch 100 Hz THD 1%

■Input terminals

Analog

- RCA stereo terminal(LINE/PHONO) ×1

Digital

- Optical digital terminal (PCM 2ch/32kHz, 44.1kHz, 48kHz) ×1
- USB Type-C terminal ×1

■Output terminal

SUBWOOFER terminal

■Other terminals

Speaker terminal

GND terminal

■BLUETOOTH Section

Communication system

- BLUETOOTH Specification version 5.3 + dual mode

Frequency band

- 2.4GHz (2.402-2.480GHz)

Modulation method

- FHSS (Frequency Hopping Spread Spectrum)

Compatible BLUETOOTH profiles

- A2DP 1.3.2, AVRCP 1.6.2, HFP1.8, HSP 1.2, SPP 1.2

Supported Codecs

- SBC

Transmission range (A2DP)

- 20 Hz - 20 kHz (Sampling frequency 44.1kHz)

Maximum communication range

- Line of sight approx. 15 m(*)

(*)The actual range will vary depending on factors such as obstacles between devices, magnetic fields around a microwave oven,static electricity, cordless phone, reception sensitivity, antenna's performance, operating system, software application, etc.

Maximum radio-frequency power transmitted in the frequency band(s)

- 2400 MHz - 2483.5 MHz (20 dBm (e.i.r.p))

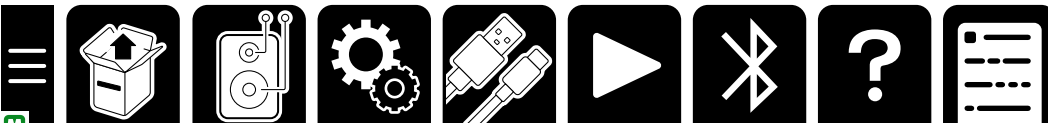

■USB Section

USB Ver.2.0, Type-C

■General

Power Supply

- AC 100 - 240 V, 50/60 Hz

Power Consumption

- 10 W

Standby mode

- BLUETOOTH : 0.3 W
- USB : 0.3 W
- OPTICAL : 0.3 W
- RCA : 0.3 W

*In this mode, when there is no signal output, the idle power consumption is 0.3 W after 15 minutes.

Dimensions (W × H × D)

- RIGHT SPEAKER : 119 mm × 176 mm × 169 mm (including speaker grilles and protrusions on the back)
- LEFT SPEAKER : 119 mm × 176 mm × 163 mm (including speaker grilles and protrusions on the back)

Weight

- RIGHT SPEAKER : 1.8 kg (including speaker grill)
- LEFT SPEAKER : 1.6 kg (including speaker grill)

■License and Trademark



The BLUETOOTH® word mark and logos are registered trademarks owned by BLUETOOTH SIG, Inc.

All other trademarks are the property of their respective owners.

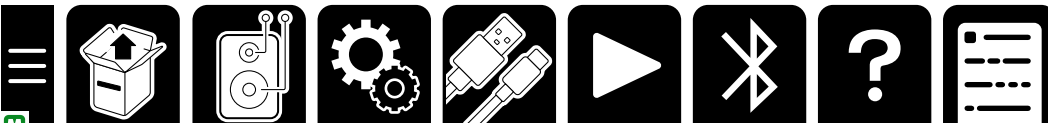

Update Information

2025-10

- Added Auto Dimmer function (→[p5](#))
- Added Auto Standby setting (→[p21](#))

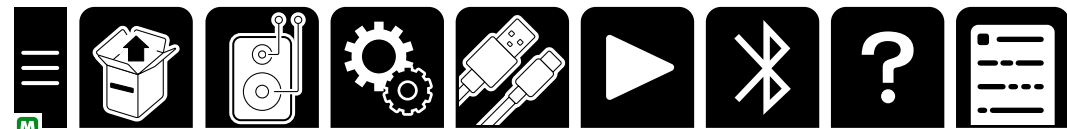

O N K Y O

SN 29404186B_EN

© Copyright 2025 Premium Audio Company Technology Center K.K. All rights reserved.

© Copyright 2025 Premium Audio Company Technology Center K.K. Tous droits de reproduction et de traduction réservés.

O2510-2