



Washer

User manual

WA54M8750A*

SAMSUNG

Contents

Safety information	4
What you need to know about the safety instructions	4
Important safety symbols	4
Important safety precautions	5
Installation	16
Unpacking your washer	16
Overview of your washer	17
Basic location requirements	19
Important note to installer	23
Step-by-step installation	23
Operating instructions	31
Loading your washer	31
Getting started	32
Washing a load of laundry	33
Control panel	33
Cycle overview	35
Options	37
Samsung Smart Home	41
Washing clothes using the option button	43
ATC (Auto Temperature Control)	44
The basics	45
Detergent use	47
Features	48
Maintaining your washer	52
Cleaning the exterior	52
Cleaning the interior	52
Storing your washer	52
Protecting the top cover and the front frame	53
Cleaning mesh filter	53
Cleaning the dispensers	53
Self Clean	55
Troubleshooting	56
Checkpoints	56
Information codes	60

Specifications	63
Fabric care chart	63
Helping the environment	65
Declaration of conformity	65
Specification sheet	66
Cycle chart	67

Safety information

Congratulations on your new Samsung washer. This manual contains important information on the installation, use, and care of your appliance. Please take some time to read this manual to take full advantage of your washer's many benefits and features.

What you need to know about the safety instructions

Please read this manual thoroughly to ensure that you know how to safely and efficiently operate the extensive features and functions of your new appliance. Please store the manual in a safe location close to the appliance for future reference. Use this appliance only for its intended purpose as described in this instruction manual.

Warnings and Important Safety Instructions in this manual do not cover all possible conditions and situations that may occur. It is your responsibility to use common sense, caution, and care when installing, maintaining, and operating your washer.

Because the following operating instructions cover various models, the characteristics of your washer may differ slightly from those described in this manual and not all warning signs may be applicable. If you have any questions or concerns, contact your nearest Samsung service center or find help and information online at www.samsung.com.

Important safety symbols

What the icons and signs in this user manual mean:

 **WARNING**

Hazards or unsafe practices that may result in **severe personal injury, death, and/or property damage**.

 **CAUTION**

Hazards or unsafe practices that may result in **personal injury and/or property damage**.

 **NOTE**

Indicates that a risk of personal injury or material damage exists.

SAVE THESE INSTRUCTIONS

These warning signs are here to prevent injury to yourself and others. Please follow them explicitly. After reading this manual, store it in a safe place for future reference.

Read all instructions before using the appliance.

As with any equipment that uses electricity and moving parts, potential hazards exist. To safely operate this appliance, familiarize yourself with its operation and exercise care when using it.

WARNING

State of California Proposition 65 Warning (US only)

This product contains chemicals known to the State of California to cause cancer and birth defects or other reproductive harm.

Important safety precautions

WARNING

To reduce the risk of fire, electric shock, or injury to persons when using your appliance, follow basic precautions, including the following:

1. Read all instructions before using this appliance.
2. Do not wash or dry articles that have been previously cleaned in, washed in, soaked in, or spotted with gasoline, dry-cleaning solvents, other flammable or explosive substances as they give off vapors that could ignite or explode.
3. Do not allow children to play on or in the appliance. Close supervision of children is necessary when the appliance is used near children.
4. Before the appliance is removed from service or discarded, remove the lid of the washing or drying compartment.
5. Do not reach into the appliance if the drum is moving.
6. Do not install or store this appliance where it will be exposed to the weather.
7. Do not tamper with the controls.
8. Do not repair or replace any part of the appliance or attempt any servicing unless it is specifically recommended in the user-maintenance instructions or in published user-repair instructions that you understand and have the skills to carry out.
9. Do not add gasoline, dry-cleaning solvents, or other flammable or explosive substances to the wash water. These substances give off vapors that could ignite or explode.

SAVE THESE INSTRUCTIONS

Safety information

- 10.** Under certain conditions, hydrogen gas may be produced in a hot water system that has not been used for 2 weeks or more. **HYDROGEN GAS IS EXPLOSIVE.** If the hot water system has not been used for 2 weeks or more, before using a washer or combination washer-dryer, turn on all hot water faucets and let the water flow from each for several minutes. This will release any accumulated hydrogen gas. As the gas is flammable, do not smoke or use an open flame during this time.

Critical installation warnings

WARNING

Plug the power cord into an AC 120 V / 60 Hz/wall socket rated at 15 amps or higher. Use the socket for this appliance only. In addition, do not use an extension cord.

- Sharing a wall socket with other appliances, using a power strip, or extending the power cord may result in electric shock or fire.
- Do not use an electric transformer. It may result in electric shock or fire.
- Ensure that the power voltage, frequency, and current match the product's specifications. Failing to do so may result in electric shock or fire.

Have this appliance installed by a qualified technician or service company.

- Failing to do so may result in electric shock, fire, an explosion, problems with the product, or injury.

Remove all foreign substances such as dust or water from the power plug terminals and contact points using a dry cloth on a regular basis.

- Unplug the power plug and clean it with a dry cloth.
- Failing to do so may result in electric shock or fire.

Plug the power plug into the wall socket in the right direction so that the cord runs towards the floor.

- If you plug the power plug into the socket in the opposite direction, the electric wires within the cable may be damaged and this may result in electric shock or fire.

This appliance must be properly grounded. Do not ground the appliance to a gas pipe, plastic water pipe, or telephone line.

- Improper grounding may result in electric shock, fire, an explosion, or problems with the product.

SAVE THESE INSTRUCTIONS

- Never plug the power cord into a socket that is not grounded correctly. Make sure the socket you use is grounded in accordance with local and national codes.

Do not install this appliance near a heater or flammable material.

Do not install this appliance in a humid, oily, or dusty location, or in a location exposed to direct sunlight or water (rain drops).

Do not install this appliance in a location where gas may leak.

- This may result in electric shock or fire.

Plug the power plug into the wall socket firmly. Do not use a damaged power plug, damaged power cord, or loose wall socket.

- This may result in electric shock or fire.

Do not pull or excessively bend the power cord.

Do not twist or tie the power cord.

Do not hook the power cord over a metal object, place a heavy object on the power cord, insert the power cord between objects, or push the power cord into the space behind the appliance.

- This may result in electric shock or fire.

Do not pull the power cord when unplugging the power plug.

- Unplug the power plug by pulling the plug.
- Failing to do so may result in electric shock or fire.

If the power plug or power cord are damaged, contact your nearest Samsung service center.

Installation cautions

CAUTION

Position the appliance so that the power plug is easily accessible.

- Failing to do so may result in electric shock or fire due to electric leakage.

Install your appliance on a level and hard floor that can support its weight.

- Failing to do so may result in abnormal vibrations, noise, or problems with the product.

Unplug the power plug when the appliance is not being used for long periods of time or during a thunder/lightning storm.

- Failing to do so may result in electric shock or fire.

SAVE THESE INSTRUCTIONS

Safety information

Critical usage warnings

WARNING

If the appliance is flooded, cut the power immediately and contact your nearest Samsung service center.

If the appliance emits a strange noise, a burning smell, or smoke, unplug the power plug immediately and contact your nearest Samsung service center.

- Failing to do so may result in electric shock or fire.

In the event of a gas leak (such as propane gas, LP gas, etc.), ventilate the area immediately. Do not turn any appliance or light on or off.

- Do not use a ventilating fan.
- A spark may result in an explosion or fire.

Do not wash items contaminated with gasoline, kerosene, benzene, paint thinner, alcohol, or other flammable or explosive substances.

- This may result in electric shock, fire, or an explosion.

Do not force the washer lid open while the washer is operating (high-temperature washing/drying/spinning).

- Water flowing out of the washer may cause burns or cause the floor to be slippery. This may result in injury.
- Forcing the lid open can damage the product or cause injury.

Make sure to remove the packaging (sponge, styrofoam) attached to the bottom of the washer before using it.

Do not insert your hand under the washer.

- This may result in injury.

Do not touch the power plug with wet hands.

- This may result in electric shock.

Do not turn the appliance off by unplugging the power plug while the washer is in operation.

- Plugging the power plug into the wall socket again may cause a spark and result in electric shock or fire.

Keep all packaging materials well out of the reach of children, as packaging materials can be dangerous to children.

- If a child places a plastic bag over his or her head, the child may suffocate.

SAVE THESE INSTRUCTIONS

Do not let children or infirm persons use this washer unsupervised.

- Failing to do so may result in electric shock, burns, or injury.

Do not insert your hand or a metal object under the washer while it is operating.

- This may result in injury.

Do not attempt to repair, disassemble, or modify the appliance yourself.

- Do not use any fuse (such as copper, steel wire, etc.) other than a standard fuse.
- If you need to repair or reinstall the appliance, contact your nearest Samsung service center.
- Failing to do so may result in electric shock, fire, problems with the product, or injury.

If any foreign substance such as water enters the appliance in any area other than the tub, unplug the power plug and contact your nearest Samsung service center.

- Failing to do so may result in electric shock or fire.

If the water supply hose comes loose from the faucet and floods the appliance, unplug the power plug.

- Failing to do so may result in electric shock or fire.

Usage cautions

CAUTION

If the washer is contaminated by a foreign substance such as detergent, dirt, food waste, etc., unplug the power plug and clean the washer using a damp, soft cloth.

- Failing to do so may result in discoloration, deformation, damage, or rust.

The clear portion of the lid can be broken by a strong impact. Take care when using the washer.

- If the clear portion is cracked or broken, it may result in injury.

After a water supply failure or when reconnecting the water supply hose, open the faucet slowly.

Open the faucet slowly after a long period of non-use.

- The air pressure in the water supply hose or the water pipe may result in damage to a part or in water leakage.

SAVE THESE INSTRUCTIONS

Safety information

If a drain error occurs during an operation, check if there is a draining problem.

- If the washer is used when it is flooded because of a draining problem, it may result in electric shock or fire due to electric leakage.

Do not insert your hand under the washer.

- This may result in injury.

Insert the laundry into the washer completely so that laundry does not get caught in the lid.

- If laundry gets caught in the lid, it may result in damage to the laundry or the washer, or result in water leakage.

Ensure that the faucet is turned off when the washer is not being used.

- Ensure that the water supply hose connectors are properly tightened.
- Failing to do so may result in property damage or injury.

Open the faucet and check if the water supply hose connector is firmly tightened and that there is no water leaking before using the product.

- If the water supply hose connectors are loose, it may result in water leakage.

Do not stand on top of the appliance or place objects (such as laundry, lighted candles, lighted cigarettes, dishes, chemicals, metal objects, etc.) on the appliance.

- This may result in electric shock, fire, problems with the product, or injury.

Do not operate the appliance with wet hands.

- This may result in electric shock.

Do not spray volatile material such as insecticide onto the surface of the appliance.

- As well as being harmful to humans, it may also result in electric shock, fire, or problems with the product.

Do not place an object that generates an electromagnetic field near the washer.

- This may result in injury due to a malfunction.

Since the water drained during a high-temperature wash or drying cycle is hot, do not touch the water.

- This may result in burns or injury.

For waterproof fabrics, only use the WATERPROOF cycle.

- Do not use other cycles for waterproof fabrics. This may result in injury or damage to the washer, walls, floor, or clothing due to abnormal vibrations.
- Set the temperature and spin according to the attached care label.

SAVE THESE INSTRUCTIONS

Do not operate the washer if the detergent dispenser is removed.

- This may result in electric shock or injury due to water leakage.

Do not insert your hand into the detergent dispenser after opening it.

- This may result in injury as your hand may be caught.

Do not place any non-laundry objects, such as shoes, food waste, or animals into the washer.

- This can cause abnormal vibrations that can damage the washer, and, in the case of pets, cause severe injury or death.

Do not press the buttons using sharp objects such as pins, knives, fingernails, etc.

- This may result in electric shock or injury.

Do not wash laundry contaminated by oils, creams, or lotions usually found in skincare shops or massage clinics.

- This may result in the rubber seal becoming deformed and water leakage.

Do not leave metal objects (safety pins, hair pins, etc.) or bleach in the tub for long periods of time.

- This may cause the tub to rust.
- If rust appears on the surface of the tub, apply a neutral cleansing agent to the surface and use a sponge to clean it. Never use a metal brush.

Do not use dry cleaning detergent in the tub and do not wash, rinse, or spin laundry contaminated by dry cleaning detergent.

- This may result in spontaneous combustion or ignition due to heat from the oxidation of the oil.

Do not use hot water from water cooling/heating devices.

- This may result in problems with the washer.

Do not use natural hand-washing soap in the washer.

- If it hardens and accumulates inside the washer, it may cause problems with the product, discoloration, rust, or bad odors.

Do not wash large laundry items such as bedding in the washing net.

- Failing to do so may result in injury due to abnormal vibrations.
- Place smaller items, such as lace socks and lingerie in the washing net.

Do not use hardened detergent.

- If it accumulates inside the washer, it may result in water leakage.

SAVE THESE INSTRUCTIONS

Safety information

Do not wash throw rugs or doormats in the washer.

- If you wash throw rugs or doormats, the sand will accumulate inside the washer. It may result in error such as no draining.

Critical cleaning warnings

WARNING

Do not clean the appliance by spraying water directly onto it.

Do not use a strong acid cleaning agent.

Do not use benzene, paint thinner, or alcohol to clean the appliance.

- This may result in discoloration, deformation, damage, electric shock, or fire.

Before cleaning or performing maintenance, unplug the appliance from the wall socket.

- Failing to do so may result in electric shock or fire.

SAVE THESE INSTRUCTIONS

Regulatory notice

FCC Notice

CAUTION

Any changes or modifications not expressly approved by the party responsible for compliance could void the user's authority to operate the equipment.

This device complies with Part 15 of FCC Rules. Operation is Subject to following two conditions:

1. This device may not cause harmful interference, and
2. This device must accept any interference received including interference that cause undesired operation.

For products sold in the US and Canadian markets, only channels 1-11 are available. You cannot select any other channels.

FCC STATEMENT:

This equipment has been tested and found to comply within the limits for a Class B digital device, pursuant to part 15 of the FCC Rules. These limits are designed to provide reasonable protection against harmful interference in a residential installation.

This equipment generates, uses, and can radiate radio frequency energy and, if not installed and used in accordance with the instructions, may cause harmful interference to radio communications. However, there is no guarantee that interference will not occur in a particular installation. If this equipment does cause harmful interference to radio or television reception, which can be determined by turning the equipment off and on, the user is encouraged to try to correct the interference by one or more of the following measures:

- Reorienting or relocating the receiving antenna
- Increasing the separation between the equipment and receiver
- Connecting the equipment to an outlet that is on a different circuit than the radio or TV
- Consulting the dealer or an experienced radio/TV technician for help.

SAVE THESE INSTRUCTIONS

Safety information

FCC RADIATION EXPOSURE STATEMENT:

This equipment complies with FCC radiation exposure limits set forth for an uncontrolled environment. This equipment should be installed and operated so there is at least 8 inches (20 cm) between the radiator and your body. This device and its antenna(s) must not be co-located or operated in conjunction with any other antenna or transmitter.

IC Notice

The term “IC” before the radio certification number only signifies that Industry Canada technical specifications were met. Operation is subject to the following two conditions: (1) this device may not cause interference, and (2) this device must accept any interference, including interference that may cause undesired operation of the device.

This Class B digital apparatus complies with Canadian ICES-003. Cet appareil numérique de la classe B est conforme à la norme NMB-003 du Canada.

For products sold in the US and Canadian markets, only channels 1-11 are available. You cannot select any other channels.

IC RADIATION EXPOSURE STATEMENT:

This equipment complies with IC RSS-102 radiation exposure limits set forth for an uncontrolled environment. This equipment should be installed and operated so there is at least 8 inches (20 cm) between the radiator and your body. This device and its antenna(s) must not be co-located or operated in conjunction with any other antenna or transmitter.

SAVE THESE INSTRUCTIONS

Open Source License Notice

The software included in this product contains open source software. You may obtain the complete corresponding source code for a period of three years after the last shipment of this product by sending an email to <mailto:oss.request@samsung.com>.

It is also possible to obtain the complete corresponding source code in a physical medium such as a CD-ROM; a minimal charge will be required.

The following URL <http://opensource.samsung.com/opensource/SimpleConnectTP/seq/0> leads to the download page of the source code made available and open source license information as related to this product. This offer is valid to anyone in receipt of this information.



SAVE THESE INSTRUCTIONS

Installation

Follow these instructions carefully to ensure proper installation of the washer and to prevent accidents when using it.

WARNING

Control board, heat sink, motor, inlet valve, and pump are intentionally not grounded and may present a risk of electric shock only during servicing.

Unpacking your washer

Unpack your washer and inspect it for shipping damage. Make sure you have received all the items shown below. If your washer was damaged during shipping, or you do not have all of the items, contact 1-800-SAMSUNG (1-800-726-7864).

To prevent personal injury or strain, wear protective gloves whenever lifting or carrying the unit.

WARNING

Packing materials can be dangerous to children; Keep all packing material (plastic bags, polystyrene, etc.) well out of children's reach.

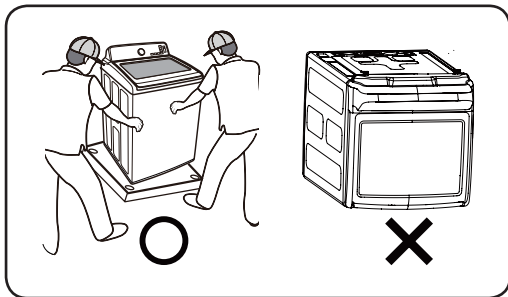

CAUTION

When unpacking the washer, a 2 person collaboration is needed. To remove the cushion bottom of the packing materials, do not tip the washer over on its front side.

the carton base, protect the side of the washer and lay it down on its side carefully. Never lay your washer on its back or front.

Overview of your washer

Make sure all the parts are included in the product package. If you have a problem with the washer or the parts, contact the Samsung customer care center or your retailer.

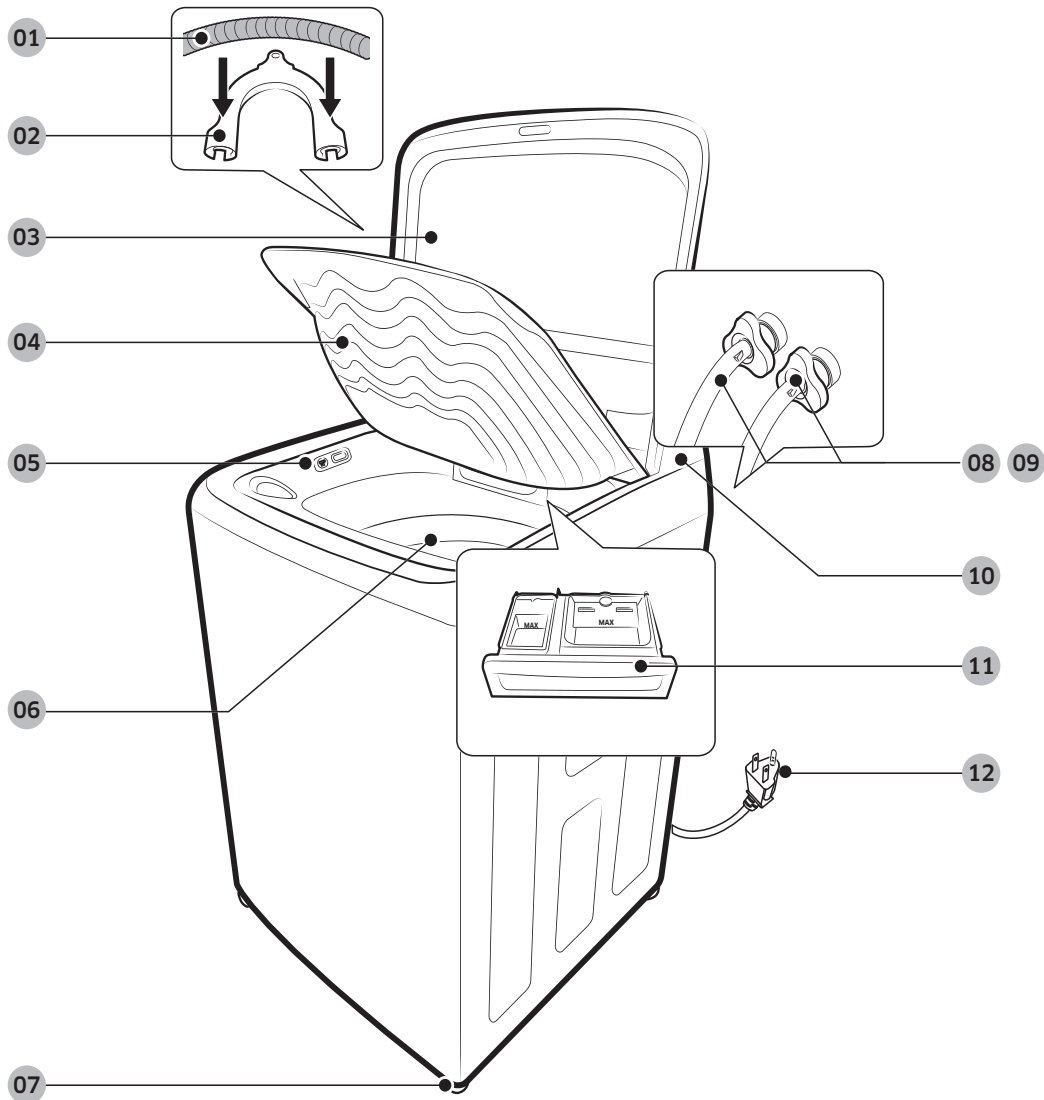

01 Drain hose

04 Built-in sink

07 Leveling feet

10 Control panel

02 Hose guide

05 Water Jet

08 Water hose (Cold)

11 Detergent drawer

03 Lid

06 Tub

09 Water hose (Hot)

12 Power cord

Installation

Parts supplied

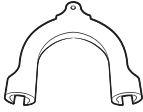

Hose guide

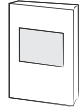

User manual



Plastic zip hose tie

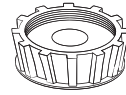

Water intake cap

Parts not supplied

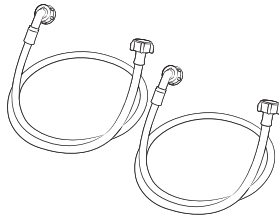

Water hoses

Tools needed for installation



Wrench



Philips screwdriver

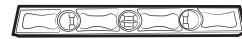

Level



Adjustable Plier

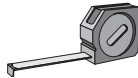

Measuring tape

NOTE

- If you lose an accessory and want to purchase a replacement, contact the the Samsung customer care center (1-800-SAMSUNG (1-800-726-7864)).
- The design of the parts and accessories may differ from the pictures above. Their design is subject to change without notice for product improvement.
- Do not reuse old hoses. Only use new water supply hoses when you install the washer. Old water supply hoses can leak or burst causing flooding and property damage.
- Confirm that there are rubber washers inside the couplings of each water supply hose.

Basic location requirements

Electrical

- 120 Volt 60 Hz 15 AMP fuse or circuit breaker.
- Individual branch circuit serving only your Washer is recommended.
- Your washer is equipped with a power cord.

CAUTION

Never use an extension cord.

Grounding

Electrical grounding is required for this appliance.

This appliance must be grounded. In the event of malfunction or breakdown, grounding will reduce the risk of electric shock by providing a path of least resistance for electric current.

This appliance is equipped with a power cord having a three-prong grounding plug for use in a properly installed and grounded outlet.

The plug must be plugged into an appropriate outlet that is properly installed and grounded in accordance with all local codes and ordinances.

WARNING

An improperly connected equipment-grounding conductor can increase the risk of electrical shock. Check with a qualified electrician or serviceman if you are not sure whether the appliance is properly grounded. Do not modify the plug provided with the appliance - if it does not fit the outlet, have a proper outlet installed by a qualified electrician.

Important safety precautions

To prevent unnecessary risk of fire, electrical shock, or personal injury, all wiring and grounding must be done in accordance with the National Electrical Code ANSI/FNPA, No.70 Latest Revision and local codes and ordinances. It is the personal responsibility of the appliance owner to provide adequate electrical service for this appliance.

CAUTION

Never connect the ground wire to plastic plumbing lines, gas lines, or hot water pipes.

Water

To correctly fill your washer in the proper amount of time, water pressure of 20 to 116 psi (137 to 800 kPa) is required. Water pressure less than 20 psi may cause water valve failure, or may not allow the water valve to shut off completely, or may extend the fill time beyond what your washer controls allow, causing your washer to turn off. A time limit is built into the controls to prevent flooding in your home if a hose becomes loose.

Installation

The water faucets must be within 4 feet (122 cm) of the back of your washer to match the inlet hoses provided with your washer.

NOTE

Accessory inlet hoses are available in various lengths up to 10 feet (275 cm) for faucets that are further away from the back of your washer.

To avoid the possibility of water damage:

- Have water faucets easily accessible.
- Turn off faucets when the washer is not in use.
- Periodically check that there is no leakage from the water inlet hose fittings.

WARNING

Check all connections at the water valve and faucet for leaks

Drain facility

The recommended height of the standpipe is 39 in (99 cm). The drain hose must be routed through the drain hose clip to the standpipe. The standpipe must be large enough to accept the outside diameter of the drain hose. The drain hose is attached to the washer at the factory.

Flooring

For best performance, you must install your washer on a solidly constructed floor. Wood floors may need to be reinforced to minimize vibration and/or unbalanced load situations. Carpeting and soft tile surfaces are contributing factors to vibration which can cause your washer to move slightly during the spin cycle.

Never install your washer on a platform or weakly supported structure.

Location considerations

Do not install your washer in areas where water may freeze, since your washer will always retain some water in its water valve, pump, and hose areas. Frozen water can damage the belts, the pump, hoses, and other components.

Alcove or closet installation

Minimum clearances for closet and alcove installations:

Sides	1 in / 25 mm	Closet front	2 in / 51 mm
Rear	6 in / 152 mm	Top	21 in / 533 mm

If the washer and dryer are installed together, the closet front must have at least a 72 in² (465 cm²) unobstructed air opening. Your washer alone does not require a specific air opening.

Recessed area

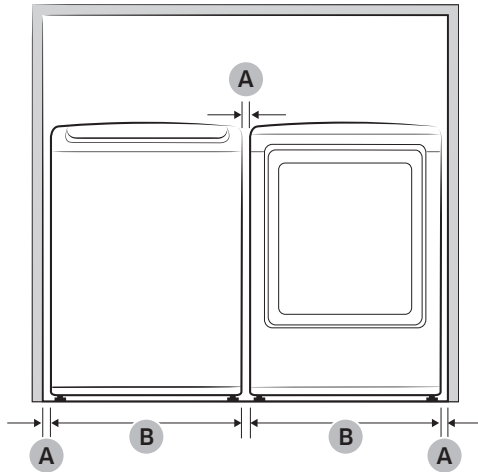

A	1 in (2.5 cm)
B	27.0 in (68.6 cm)

Side view - closet or confined area

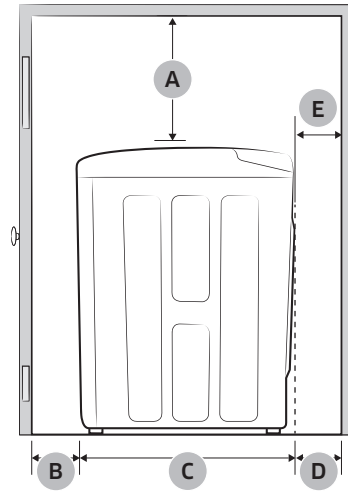

A	21 in (53.3 cm)
B	2 in (5.1 cm)
C	29 7/16 in (74.4 cm)
D	6 in (15.2 cm)
E	<p>Gap between end of water valve and the wall</p> <ul style="list-style-type: none"> Case 1. Assemble supply hose after installing : Over 4 in (10 cm). Case 2. Assemble supply hose before installing : Over 3 in (8 cm).

Installation

Required dimensions for Installation

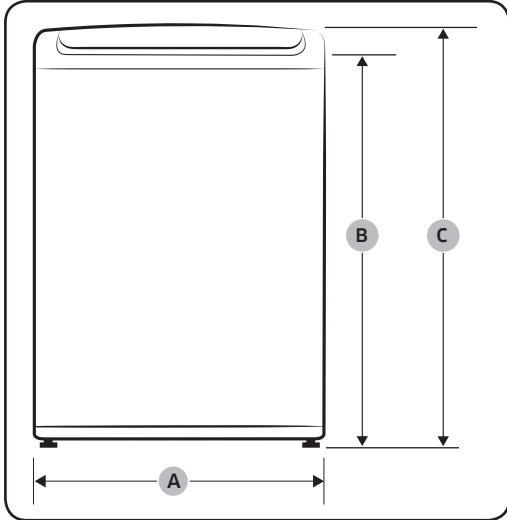

A	27.0 in (68.6 cm)
B	39.2 in (99.5 cm)
C	42.4 in (107.7 cm)

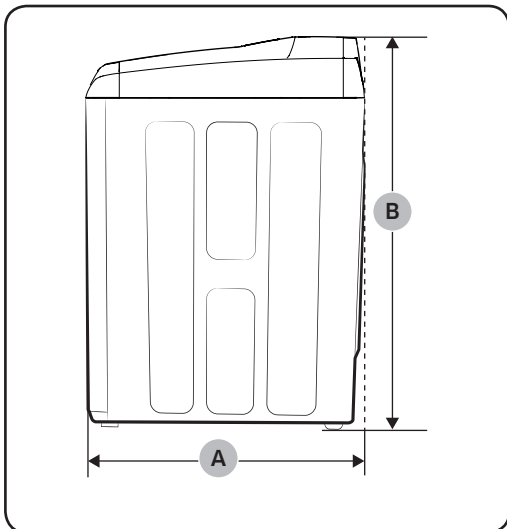

A	29.3 in (74.4 cm)
B	42.4 in (107.7 cm)

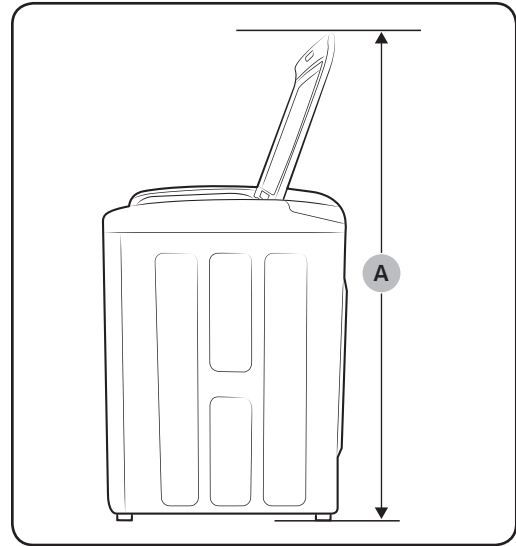

A	61.0 in (155.0 cm)
---	--------------------

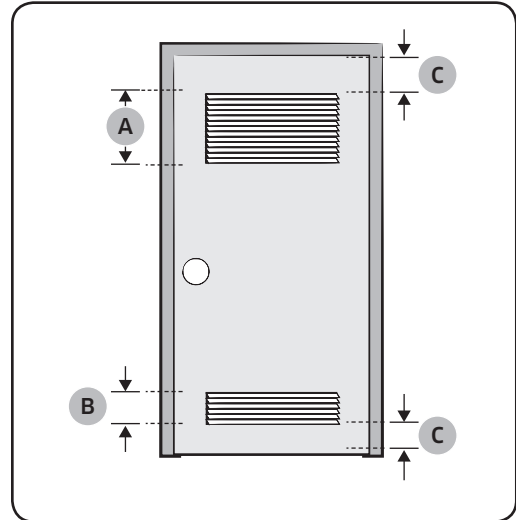

A*	48.0 in ² (310.0 cm ²)
B*	24.0 in ² (155.0 cm ²)
C	3.0 in (7.6 cm)

NOTE
* Required spacing

Important note to installer

Please read the following instructions carefully before installing your washer. These instructions should be retained for future reference. We recommend you hire a professional to install this washer.

Installation flow chart

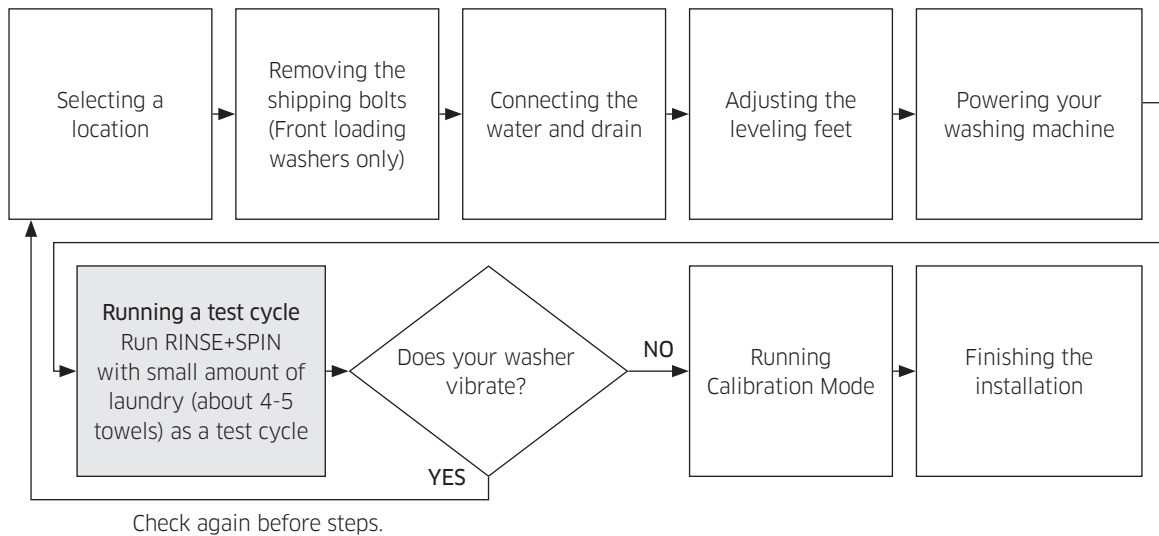

Step-by-step installation

STEP 1 Selecting a location

NOTE

Before you install the washer, make sure the location:

- Has a hard, level surface without carpeting or flooring that may obstruct ventilation.
- Is away from direct sunlight.
- Has adequate ventilation.
- Is not exposed to freezing temperatures (temperatures under 32 °F or 0 °C).
- Is away from heat sources such as oil or gas.
- Has enough space so that the washer doesn't rest on its power cord.

Installation

STEP 2 Connecting the water supply hoses

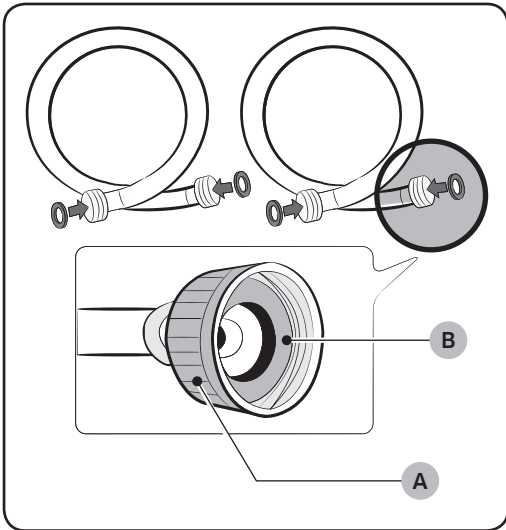

⚠ CAUTION

Before installing the water supply hoses, make sure there are **rubber gaskets (B)** inside the **couplings (A)** at both ends of each new water hose. Installing the water supply hoses without rubber gaskets can cause water leakage.

⚠ CAUTION

When you initially install the washer, be sure to use new hoses. Failing to do so may result in a water leakage or overflow and may damage your property.

⚠ CAUTION

Do not connect multiple water supply hoses together to increase the length of the supply hose. Hoses connected this way can leak and the leakage can cause electrical shock. If a hose is too short, replace the hose with a longer, high pressure hose.

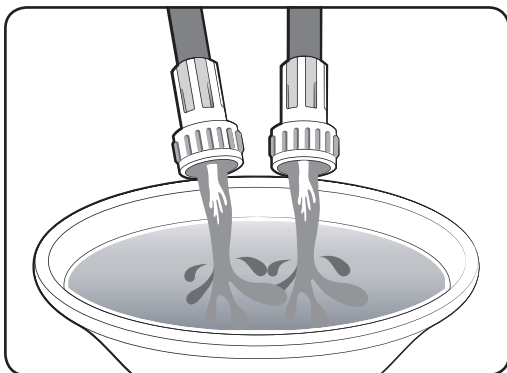
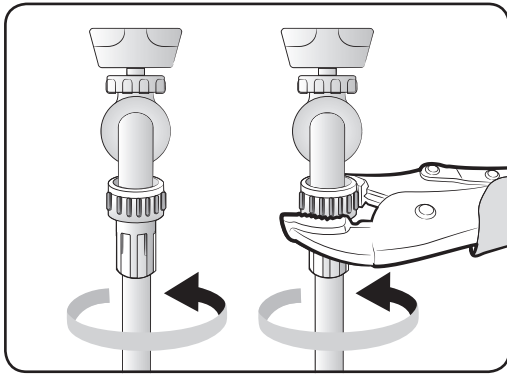
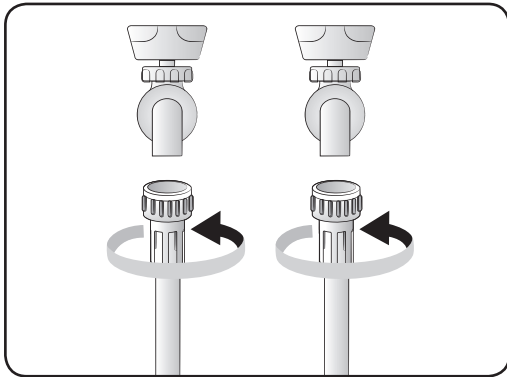

1. Connect the ends of the water supply hoses to the hot and cold faucets.
2. Tighten the fittings by hand until they are snug, and then tighten them an additional two-thirds of a turn with pliers.

⚠ CAUTION

When you fasten the fittings, do not fasten them too tightly or apply tape or sealant to the faucets or water supply intakes. This can damage the fittings.

📄 NOTE

After you have connected the water supply hoses to the faucets, ensure that they are connected correctly by pulling the water supply hoses downwards.

3. Place the unconnected ends of the hoses into a bucket and open the faucets connected to the two water supply hoses for 10 or 15 seconds to remove any foreign substances from the hoses. Close the faucets before continuing.

Installation

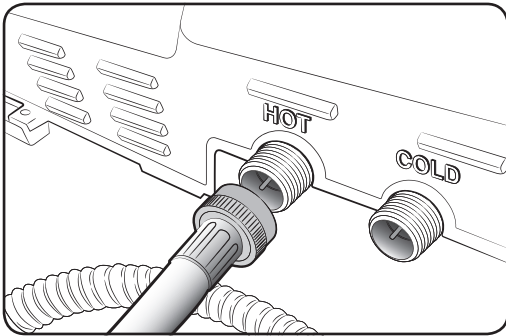

4. Connect the ends of the water supply hoses to the water supply intake connections at the back of the washer.

⚠ CAUTION

The water supply hose connected to the hot faucet must be connected to the hot water supply intake and the water hose connected to the cold faucet must be connected to the cold water supply intake.

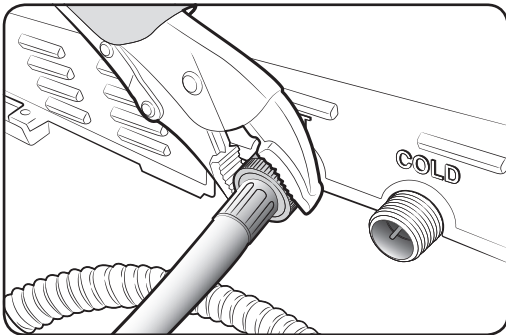

5. Tighten the fittings by hand until they are snug, and then tighten them an additional two-thirds of a turn with a plier.

📄 NOTE

To ensure the correct water usage, connect both the hot and cold water faucets. If either or both are not connected, the washer will display a “4C” (no fill) code when you run it.

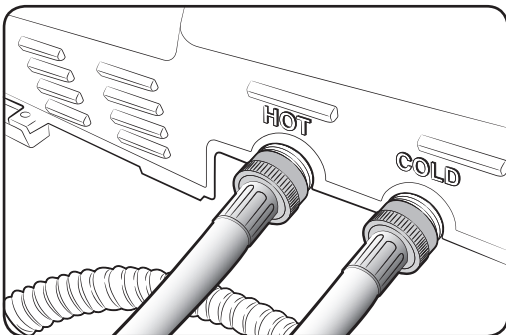

📄 NOTE

If you do not want to use the hot water supply hose, insert the water intake cap onto the hot water supply intake. Then, select **Tap Cold** for the water temperature. If you select **Tap Cold**, all water temperature options are turned off.

⚠ CAUTION

Confirm that the water supply hoses are not twisted or bent. If the hoses are twisted or bent, the hoses can leak and cause electric shock due to water leakage.

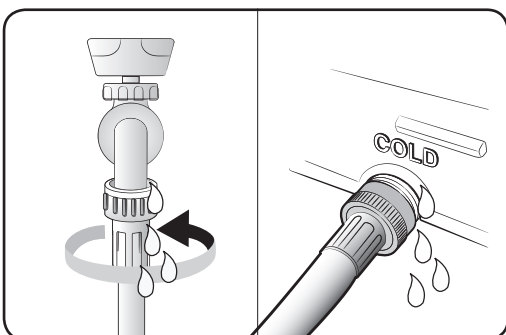

6. Turn on the hot and cold water supplies and check the water supply intake connections and the faucets for water leaks.

STEP 3 Connecting the drain hose

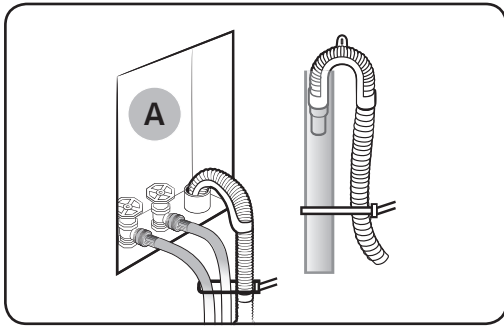

The end of the drain hose can be positioned in three ways:

In a wall standpipe or floor standpipe

The standpipe must be no lower than 39 in (99 cm) and no higher than 96 in (245 cm). If the drain pipe is built into the wall along side of the **water faucets (A)**, fasten the drain hose to the water hoses using a plastic zip hose tie.

NOTE

- Make sure that the connection between the drain hose and the standpipe is not airtight.

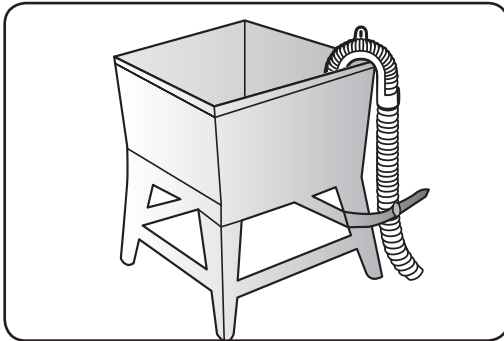

In a laundry tub

The tub must be no lower than 39 in (99 cm) and no higher than 96 in (245 cm).

Assemble the supplied Hose guide at the end of the drain hose, attach the hanger to laundry tub as shown, and then fasten the hose to a leg of the laundry tub using a plastic zip hose tie.

Installation

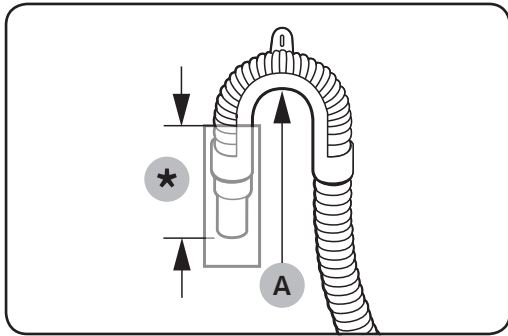

NOTE

Connect the **hose guide (A)** within 3-5 in (7.6-12.7 cm)* from the end of the drain hose. If the drain hose is extended beyond the end of the hose guide, mold or microorganisms could spread inside the washer.

NOTE

The drain hose can be installed to a maximum height of 96 in (245 cm), but the draining capability can be reduced at this height. It can cause the washer to have an odor because of water remaining in the drain system.

NOTE

If the drain hose is installed below 39 in (99 cm), water can be drained in cycles due to a siphon phenomenon. It causes the washer to display a “4C”.

STEP 4 Leveling your washer

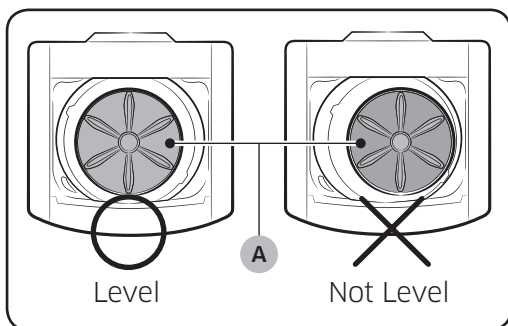

See if the washer is level by checking the position of the tub:

1. Slide the washer into position.
2. Open the lid of the washer, and pour water into the tub to just below the pulsator level.

NOTE

WA54M8750A* models have a built-in sink over the pulsator level. Open a built-in sink and check the level visually.

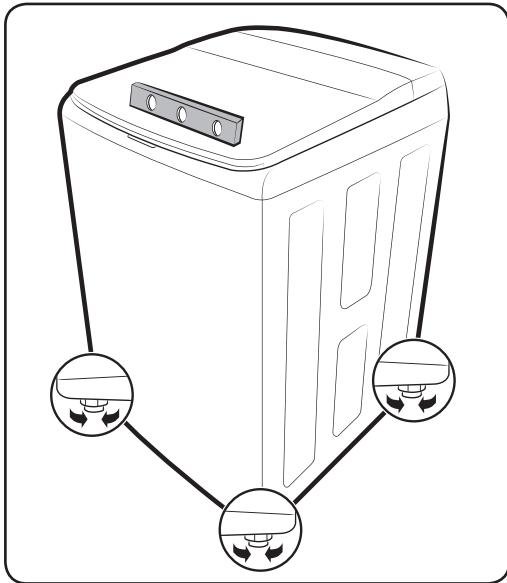

3. If the washer is level, the pulsator (A) will be positioned at the center of the tub as shown in the figure on the previous page. If it isn't, level your washer by turning the front leveling feet clockwise or counterclockwise as necessary.

NOTE

Turn the front leveling feet clockwise (B) to lower the washer, and counterclockwise (C) to raise the washer.

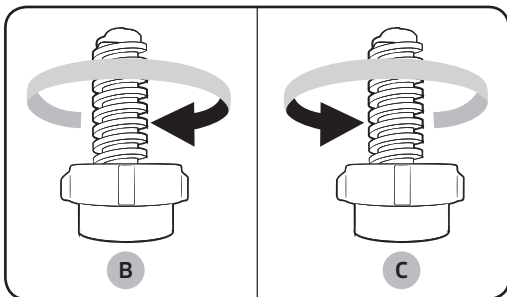

STEP 5 Powering your washer

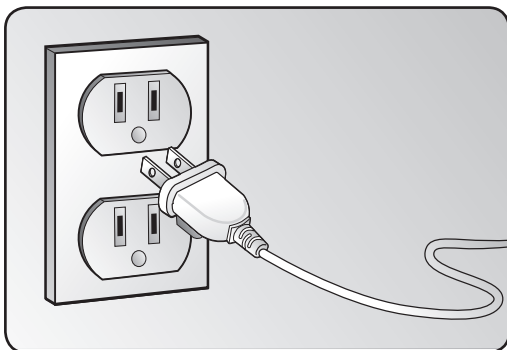

Plug the power cord into a 3-prong, well grounded, 120 volt 60 Hz, approved electrical outlet protected by a 15-amp fuse or comparable circuit breaker.

Your washer is grounded through the third prong of the power cord when plugged into a three-prong grounded electrical outlet.

Test run

Make sure that you installed your washer correctly by running the **RINSE+SPIN** after the installation is complete. See Step 6 on the next page.

Installation

STEP 6 Running a test cycle

Run a test cycle as follows to check if your washer is properly installed.

1. Load about 6 pounds of laundry into the tub.
2. Press **POWER** to turn on your washer.
3. Select **RINSE+SPIN** by pressing the **Cycle Selector**.
4. Press and hold **START/PAUSE** to start the test cycle.
5. The washer should not rock or vibrate excessively when water is supplied or when washing or spinning, and should drain well during the spin cycle.

NOTE

If water leaks while water is being supplied or drained, check the water connections. Refer to the “**STEP 2 Connecting the water supply hoses**” section on page **24** for instructions.

NOTE

If the washer rocks and vibrates excessively, level your washer again. Refer to the “**STEP 4 Leveling your washer**” section on page **28** for instructions.

STEP 7 Calibration Mode

Your Samsung washer detects laundry weight automatically.

For more accurate weight detection, please run Calibration Mode after installation is complete.

To run Calibration Mode, follow these steps:

1. Remove laundry or any contents from the washer, and then turn it on.
2. Press and hold **Temp.** and **Delay End** simultaneously for at least 3 seconds.
3. Press and hold **START/PAUSE** to activate Calibration Mode.
4. The pulsator rotates clockwise and counterclockwise for approximately 1 minute.
5. When Calibration Mode is finished, “**0**” appears in the display, and the washer automatically turns off. The washer is now ready for use.

Operating instructions

WARNING

To reduce the risk of fire, electric shock, or injury to persons when using your appliance, follow basic precautions, including the following:

Loading your washer

- Fill the tub with dry, unfolded clothes.
- Space the clothes evenly to enhance washing efficiency and performance and prevent excess wear or wrinkling of the clothes.
- Wash delicate items such as bras, hosiery, and other lingerie in the Delicates cycle with similar lightweight items.
- When washing big bulky items or a few smaller items that don't fill the tub completely – a rug, a pillow, stuffed toys, or one or two sweaters, for example – add a few towels to improve spin performance.
- Wash bulky items (comforters, blankets, etc.) in the Bedding/Waterproof cycle only. Do not wash bulky items using any other cycle.

NOTE

During the spin cycle, the washer may add additional water to redistribute the clothes and correct an imbalance inside the drum.

- When washing heavily soiled loads, do not overload your washer to ensure good cleaning results.

CAUTION

- Inflatable items may cause damage to the laundry or the machine during the washing or drying process.
- Regardless of their size, it is safer and more effective to wash blankets or quilts one item at a time. Two different-sized blankets in the same load may compromise drying performance because the load is unbalanced.

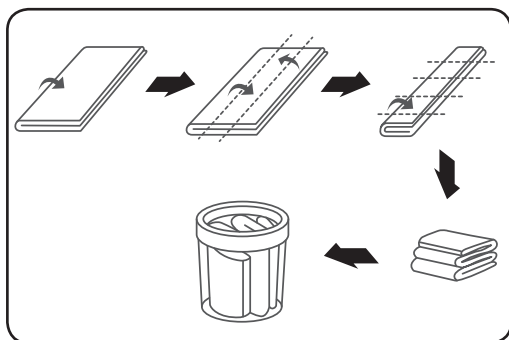

To insert a blanket

Fold the blanket into the blanket-specific net as shown, and then insert it into the tub below the plastic area of the tub.

CAUTION

Make sure the laundry is inserted completely.

- Laundry that is not completely inserted into the tub may cause damage to the washer or the laundry itself, or cause a water leak.
- Do not overload the tub. Make sure no laundry is left outside of the tub.



Operating instructions

To add a forgotten item:

1. Press **START/PAUSE** to pause the washer.
2. Wait for the door to unlock automatically, and then open the door.
3. Add the item, close the door, and then press and hold **START/PAUSE**. The cycle will resume.

Getting started

1. Load your washer.
2. Add liquid (or powdered) detergent and additives to the dispenser (see the "**Detergent use**" section on page 47).
3. Select the appropriate cycle and options for the load (see the "**Washing a load of laundry**" section page 33).
4. Close the lid.
5. Press and hold **START/PAUSE**.
6. The **Wash** Indicator illuminates.
7. The estimated cycle time will appear in the display. The time may fluctuate to indicate the time remaining in the cycle.



NOTE

The actual time required for a cycle may differ from the estimated time in the display depending on the water pressure, water temperature, detergent, and laundry.

8. Before your washer starts to fill, it will make a series of clicking noises to check the door lock and do a quick drain.



NOTE

- When the cycle is complete, the  **Door Lock** indicator will go out and "0" will appear in the display.
- Pressing **POWER** cancels the cycle and stops your washer.
- The **Wash**, **Rinse**, and **Spin** indicators will illuminate during those portions of the cycle.



Washing a load of laundry

WARNING

To reduce the risk of fire, electric shock, or injury to persons, read the IMPORTANT SAFETY INSTRUCTIONS before operating this appliance.

Control panel

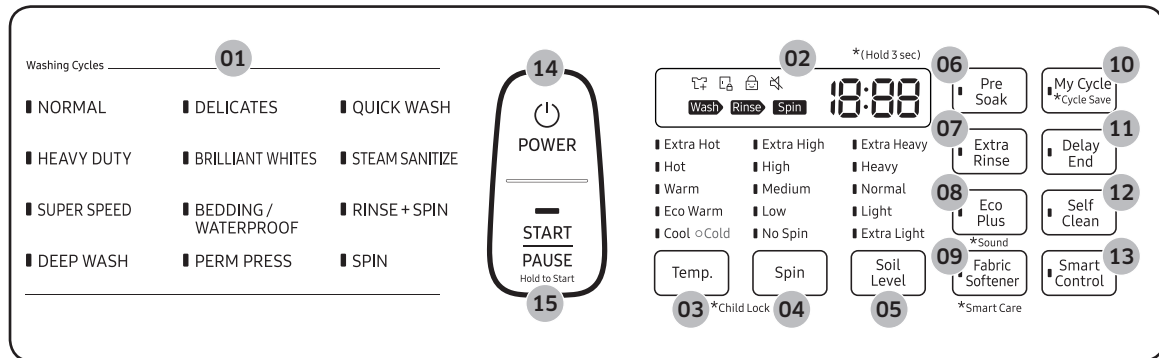

01 Cycle Selector	Press to select a desired cycle in the left-most portion of the panel. When a cycle is selected, the cycle indicator lights up.
02 Display	Provides instructions and diagnostics while keeping you updated on the cycle status and time remaining.
03 Temp.	Press this button repeatedly to cycle through the different water temperature options. <ul style="list-style-type: none"> • Extra Hot - Heavily soiled, colorfast items. • Hot - Whites and heavily soiled, colorfast items. • Warm - Colorfast items. • Eco Warm - Moderately soiled, colorfast items; most wrinkle-free items. • Cool - Brightly colored, very lightly soiled items. • Cold - Cold water with no warm water added.
04 Spin	Press this button repeatedly to cycle through the different spin speed options. <ul style="list-style-type: none"> • Extra High - Removes more water from loads during spin. • High - Use for underwear, t-shirts, jeans, and sturdy cottons. • Medium - Use for jeans, wrinkle-free or wash-and-wear items, and synthetics. • Low - Use for delicate items needing a slow spin speed. • No Spin - Drains your washer without spinning. Use for extremely delicate items that cannot tolerate any spin.

Washing a load of laundry

05 Soil Level	<p>Press this button to select the soil level/washing time.</p> <ul style="list-style-type: none"> • Extra Heavy - For heavily soiled loads. • Heavy - For heavily soiled loads. • Normal - For moderately soiled loads. This setting is best for most loads. • Light - For lightly soiled loads. • Extra Light - For lightly soiled loads.
06 Pre Soak	Adds 18 minutes soaking time at the start of the wash cycle for better stain removal.
07 Extra Rinse	Add an additional rinse at the end of the cycle to more thoroughly remove laundry additives and perfumes.
08 Eco Plus	Press to increase your energy savings on your wash cycles. (Less hot water consumption)
09 Fabric Softener	Adds an additional rinse at the end of the cycle to more thoroughly remove laundry additives and perfumes.
10 My Cycle	Press and hold for 3 seconds to save your own cycle. Create and/or use a cycle you have customized with cycle, temperature, spin speed, soil level, and option settings you have selected.
11 Delay End	Delay the end of any cycle for up to 24 hours in one-hour increments. Displayed hour indicates the time the wash will be ended.
12 Self Clean	Use to clean dirt and bacteria from the drum. Regular use (after every 20 washes) is recommended. No detergent or bleach is needed.
13 Smart Control	After connecting the washer to your home network using the Samsung Smart Home app, you can control the washer remotely. When you start Smart Control, the Smart Control indicator blinks and the front door locks. The washer enters waiting mode and waits for remote commands.
14 POWER	Press once to turn your washer on. Press again to turn your washer off. If the washer is left on for more than 10 minutes without any buttons being pressed, the power automatically turns off.
15 START/PAUSE (Hold To Start)	Press and hold to start operation or press to stop operation.



NOTE

We recommend that you untangle the items before washing.
Do not put objects on the washer, especially on the feature panel.

Cycle overview

NOTE

To minimize wrinkling of laundry, select **PERM PRESS**.

Cycle	Description
NORMAL	For most fabrics including cottons, linens, and normally soiled garments.
HEAVY DUTY	For sturdy, colorfast fabrics, heavily soiled garments.
DELICATES	For sheer fabrics, bras, lingerie, silks, and other handwash-only fabrics. For best results, use liquid detergent.
DEEP WASH	To use more water in washing and rinsing.
SUPER SPEED	For normally soiled loads (up to 8 lb).
STEAM SANITIZE	For heavily soiled, colorfast garments. (less than 14lbs)  NOTE If you select pause during the heating portion of the Sanitize Cycle, your Washer door will remain locked for your safety.
BEDDING/ WATERPROOF	For bulky and large items, such as comforters, blankets, and sheets, and waterproof or water resistant items. When washing comforters, use liquid detergent.  CAUTION ※ Do not wash waterproof items and non-waterproof items together. ※ Check the specification label on each item to see if the item is waterproof. ※ Use the BEDDING/WATERPROOF cycle for waterproof or water-resistant items such as plastic mats, ski pants, raincoats, and comforters which hardly absorb water.
PERM PRESS	For wash-and-wear, synthetic fabrics, and lightly to normally soiled garments.
BRILLIANT WHITES	For white fabrics with or without bleach.

Washing a load of laundry

Cycle	Description
QUICK WASH	For lightly soiled garments needed quickly.
RINSE + SPIN	Use for loads that need rinsing only or to add rinse-added fabric softener to a load.
SPIN	Drains the water and spins at a high speed.

Options

Child Lock

To prevent children or infants from accidentally starting or setting the washer, Child Lock locks all buttons except for the **POWER** button.

Activating the Child Lock function

Press and hold **Temp.** and **Spin** simultaneously for approximately 3 seconds.

- When you activate the Child Lock function, the  **Child Lock** indicator blinks.

Using the Child Lock function

If the lid is opened when the Child Lock function is on, “**dc**” is displayed and an alarm sounds.

- If the water level in the tub is above the safe water level, “**dc**” is displayed on the LED display and the washer starts to drain water by force after 30 seconds.
- If the water level in the tub is above the safe water level and the Child Lock function is turned on while the lid is open, “**CL**” is displayed on the LED display even if the washer is turned off and the washer drains water by force.
- When Child Lock is on and the washer is off, if the water in the tub is above the Reset water level and the lid is opened, “**CL**” is displayed on the LED display. No alarm sounds, but the washer drains the water. When the draining operation finishes, the power automatically turns off again.
- If you activate the Child Lock function while the washer is running, the **START/PAUSE** button will not work.

- After the compulsory drain, the “**CL**” blinks at 1 second intervals and the washer enters the “**CL**” mode. (When the washer is in the “**CL**” mode, only the **POWER** button works.)
- To cancel the “**CL**” mode, turn the power off and then on again.
- To cancel the “**dc**” mode, deactivate the Child Lock function. To deactivate the Child Lock function, press and hold **Temp.** and **Spin** simultaneously for at least 3 seconds.

NOTE

Adding laundry when Child Lock is on

To add laundry, deactivate the Child Lock function. To deactivate the Child Lock function, press and hold **Temp.** and **Spin** simultaneously for at least 3 seconds. See the “**Pause Option**” section on page 43 for additional details.

Deactivating the Child Lock function

Press and hold both **Temp.** and **Spin** simultaneously for approximately 3 seconds.

- When you deactivate the Child Lock function, the  **Child Lock** indicator is turned off.
- The Child Lock function prevents children or the infirm from accidentally operating the washer and injuring themselves.

WARNING

If a child enters the washer, the child may become trapped and suffocate.

Washing a load of laundry

CAUTION

- Once you have activated the Child Lock function, it continues working even if the power is turned off.
- Forcing the lid open can result in injury or damage to the product.

NOTE

To add laundry after you have activated the Child Lock function, you must first deactivate the Child Lock function.

Sound

The Sound Off function can be selected during all cycles.

Garment Plus

You can add or take out laundry items even after the wash has started, as long as the  Garment Plus indicator is on. Pressing **START/PAUSE** unlocks the lid. If you open the lid and want to continue the wash cycle, close the lid, and then press **START/PAUSE**.

NOTE

If you have activated the Child Lock, you must deactivate it first. See page 37.

My Cycle

Lets you save a custom wash cycle (temperature, spin, soil level, etc.) and then recall and use it with one button convenience.

To save a cycle and selected options as your My Cycle, follow these steps:

1. Press **POWER**.
2. Select a cycle using the **Cycle Selector**.
3. After cycle selection, set each option.

NOTE

See the “Cycle chart” section on page 67 for available option settings with each cycle.

4. You can then store the selected cycle and options by pressing and holding **My Cycle** for longer than 3 seconds. The cycle and options you select will be displayed the next time you choose the My Cycle function.
5. Press **My Cycle** to load and use the saved My Cycle options. The “My Cycle” LED lights up indicating activation and the chosen cycle and option lights blink.

NOTE

You can change the My Cycle settings by repeating the process above. The last saved settings will be displayed the next time you choose the My Cycle function.

NOTE

If you press **My Cycle** and release it within 3 seconds, the previously saved cycle and options appear. If you press and hold **My Cycle** for 3 seconds or longer, the currently set cycle and options are saved and the LED blinks for 3 seconds.

Delay End

You can set the washer to start your wash automatically at a later time by choosing a delay time.

The hour displayed indicates the time at which the wash will be ended.

1. Set your wash cycle.
2. Press **Delay End** repeatedly until the delay time is set.

3. Press **START/PAUSE**. The “Delay End” indicator will be lit, and the clock will begin counting down until it reaches the set time.
4. To cancel a Delay End function, press the **POWER** button and then turn the washer on again.

Pre Soak

Use this function when the laundry is heavily contaminated or stained. This function improves the wash performance by adding a Pre Soak cycle.

- If you select this function, the total cycle time is increased by 18 minutes.
- When the Pre Soak cycle starts, the washer repeats a wash cycle after supplying water and then performs a 18-minute soak cycle.
- When the Pre Soak cycle is complete, the configured wash cycle starts without draining water.

Eco Plus

This function sets the temperature somewhat lower than the typical washing cycle and extends the wash time slightly. With laundry time slightly extended, it's possible to keep the same level of washing performance with cooler water. This function reduces energy consumption and maintains the quality of the wash.

Mist Shower

Mist Shower sprays water from a nozzle that is independent of the main water supply system. The water soaks the laundry with additional water from the beginning of the rinse cycle and provides a more effective rinse. (The Mist Shower function may not work if there is too large of a load in the machine.)

Smart Care

If your washer displays an error code, this function lets see the meaning of the code and the countermeasures you can take on a smartphone.

1. To enable the Smart Care function, press and hold **Fabric Softener** for 3 seconds after turning the power on or when an error occurs.

NOTE

The error code history is deleted after you use this function.

2. The Smart Care indicator is lit on the display.
3. Run the Smart Care app on your smart phone.
 - Android: Galaxy S series, Galaxy Note series. (Other devices may not run the app properly.)
Supported OS : Android 2.2 or higher
 - iOS: iPhone series
Supported OS : iOS 4.3 or higher
4. Focus your smart phone's camera on the display panel of the washer.

Washing a load of laundry

5. If the smart phone's camera is focused on the display panel of the washer, the panel and error message are automatically recognized and the error type and countermeasures are displayed on the smart phone.
6. If the smartphone fails to recognize the error code more than twice, enter the error code displayed on the display panel of the washer manually into the Smart Care app.

NOTE

Downloading the Smart Care app

- Download the Samsung Laundry App into your mobile phone from the Android market or Apple App store. (Search word : Samsung Smart Washer/Dryer)

NOTE

Precautions when using Smart Care

- If light from a light bulb, fluorescent bulb, or lamp is reflected on the display panel of the washer, the smartphone may not be able to recognize the panel or error message easily.
- If you hold the smartphone at too large an angle relative to the front of the display panel, it may not be able to recognize the error code. For best results, hold the smartphone so that the front of the panel and the smartphone are parallel or nearly parallel.

Samsung Smart Home



This product is a smart washer that supports the Samsung Smart Home service.

The amount of time the EZ setup function (for connecting the washer to your network) can take to complete the network connection varies, depending on your network conditions.

Installation

Visit the Google Play Store, Galaxy Apps, or Apple App Store and search for “Samsung Smart Home”. Download and install the Samsung Smart Home app provided by Samsung Electronics to your smart device.

NOTE

- The Samsung Smart Home app is designed for Android 4.0 (ICS) or higher, or iOS 8.0 or higher, and is optimized for Samsung smartphones (Galaxy S and Galaxy Note series).
- On other devices, some functions may operate differently.
- For improved performance, the Samsung Smart Home app is subject to change without notice.

Registering a Samsung account

To use the Samsung Smart Home app, you must first sign in to your Samsung account. If you don't have a Samsung account, select **Register** in the app, and then follow the on-screen instructions to create an account.

NOTE

- If you have a registered Samsung account, log into your Samsung account. If you have a Samsung smartphone, you can go to the **Settings** menu on your smartphone, select **Accounts**, and then sign in to your Samsung account. This will allow you to log in without additional authentication.
- For third-party smart phones, the app account must be the same as the EZ Setup account.

Washing a load of laundry

Getting started

Using Samsung Smart Home, you can control your washer from your smart device remotely. For improved performance, the content and design of the app is subject to change without notice.

1. Launch the Samsung Smart Home App on your smartphone.
2. If 'Washer' is not listed, tap **Add Device** > **Select other device** > **Washer** on the app screen.
3. Press and hold **Smart Control** on your washer's control panel for more than 5 seconds until the 'AP' message appears on the display.
4. When the device registration is complete, turn on the Smart Control function on your washer and control your washer remotely.

Washing clothes using the option button

Your new washer makes washing clothes easy, using Samsung's "Fuzzy Control" automatic control system. When you select a wash program, the machine will set the correct temperature, washing time, and washing speed.

1. Press **POWER**.
2. Open the lid.
3. Load the articles of clothing one at a time loosely into the drum, without overfilling it.
4. Add liquid (or powdered) detergent, softener, and/or bleach (if necessary) to the appropriate compartments. See the "Detergent use" section on page 47.
5. Close the lid.
6. Use the **option button** to select the appropriate cycle according to the type of material: **NORMAL, HEAVY DUTY, DELICATES, DEEP WASH, SUPER SPEED, BEDDING/WATERPROOF, PERM PRESS, BRILLIANT WHITES, QUICK WASH, RINSE+SPIN**, and **SPIN**. The relevant indicators will illuminate on the control panel.
7. At this time, you can control the wash temperature, the number of rinse cycles, the spinning speed, and the delay time by pressing the appropriate option button.
8. Press and hold **START/PAUSE** and the wash will begin. The process indicator will light up and the remaining time for the cycle will appear in the display.

Pause Option

To remove or add laundry items, follow these steps:

1. Press **START/PAUSE** to unlock the lid.

NOTE

The lid cannot be opened when the water is too **HOT**.

2. Remove or add laundry items.
3. Close the lid, and then press and hold **START/PAUSE** to restart the wash.

NOTE

If you have Child Lock on, you must deactivate it first. See page 37.

When the cycle is finished:

After the total cycle has finished, the power will turn off automatically.

1. Open the lid.
2. Remove laundry.

Washing a load of laundry

ATC (Auto Temperature Control)

The ATC function controls wash water temperature using the washer's built-in temperature sensor (thermistor).

NOTE

By reacting to changes in external and internal temperatures, the ATC function maintains the correct wash temperature for each cycle, providing the best washing performance while using the least amount of energy.

NOTE

New washers must reduce the amount of energy usage as a first priority. When you use the most commonly used wash cycle, Normal (which is the regulation and UL cycle), you will notice more cold water entering the washer as an energy saving step. This is normal.

In the Normal cycle, the hot water temperature is similar to acceptable adult bath water temperature and warm water temperature is similar to comfortable swimming-pool water temperature.

NOTE

If you want to wash clothes at different water temperatures, you should choose a different cycle, and then choose a specific temperature (Hot/Warm/Eco Warm).

The basics

Prewash (Water Jet & Built-in sink)

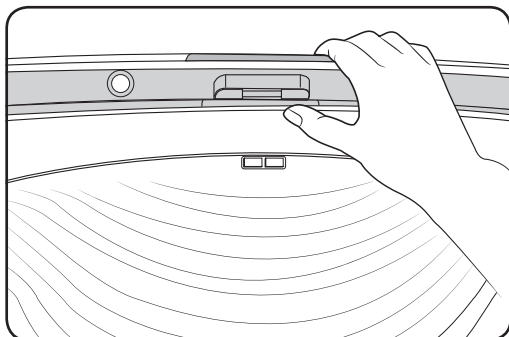
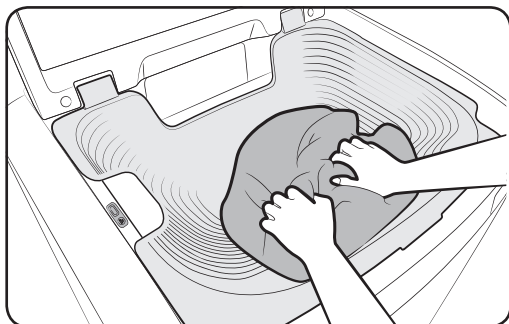
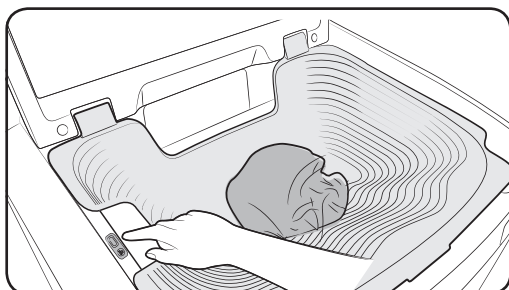
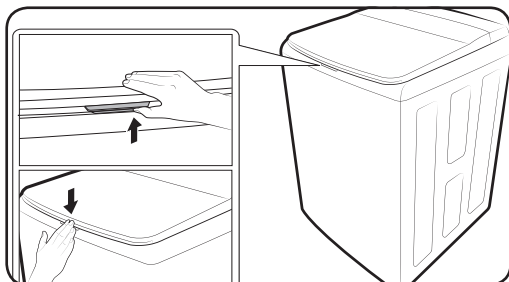

Water Jet function and the Built-in sink let you hand-wash items before you place them in the washing machine. The Water Jet function is available only when the lid is open and the water level is set to less than High. To hand-wash, use the Built-in sink that is designed to facilitate hand-washing.

1. With the lid open, lower the Built-in sink . To open only the lid, press and release the front middle of the lid. **To close and lock both the lid and the Built-in sink, press down on the lid until you hear a click.**
2. Put the clothes you want to hand-wash into the sink.
3. Press Water Jet to supply water to the Built-in sink, and then hand-wash.
4. When done, gently lift up the Built-in sink to drain water into the tub.

NOTE

- If you want to hand-wash while the washer is operating, press **START/PAUSE** to stop operation, and then follow steps 1-4 above.
- If you open both the lid and the Built-in sink, lower the Built-in sink manually for hand-washing.

[The Water Jet stops]

- The Water Jet function stops operating automatically when the washing machine detects the maximum water level.
- The Water Jet function stops operating automatically 5 minutes after it begins. To add more water, press Water Jet again to resupply water.

Washing a load of laundry

[Draining water added by the Water Jet function]

- Select a cycle and press **START/PAUSE**. The washer drains the water.
- If the washer is off before it starts the wash cycle, it drains the water added by the Water Jet function. However, if you turn the washer off during a wash cycle to use the Water Jet function, and then turn the washer back on, it does not drain the water.

NOTE

- The Water Jet function supplies water through the Mist Shower nozzle for 1 second when it is first activated after the washing machine turns on, and then through the Water Jet nozzle.

CAUTION

- Do not over-use the Water Jet function. Excessive use increases water consumption.
- When pouring water from the Built-in sink into the tub, do it gently. Otherwise, water may overflow and spill out of the tub.
- Use caution when removing laundry from the tub. You may bump your head on the Built-in sink.
- Do not block the Water Jet outlet with hands. Water may leak outside the tub, causing a system failure.
- Put only clothes to prewash in the Built-in sink. Do not clean shoes, wash food, or wash pets in the Built-in sink.
- Do not open the Built-in sink quickly. Water remaining in the sink may splash on the lid or control panel.
- Due to differences in air pressure, water coming from the Water Jet outlet may splatter when you first activate it.
- Make sure the lid is closed tightly before you start a load of laundry.

Detergent use



Your washer is designed to use high efficiency (HE) detergents.

- For the best cleaning results, use a high efficiency detergent such as Tide HE, Wisk HE, Cheer HE or Gain HE*. High efficiency detergents contain suds suppressors that reduce or eliminate suds. When fewer suds are produced, the load tumbles more efficiently and cleaning is maximized. (* Brand names are trademarks of their respective manufacturers.)

WARNING

Regular detergent is not recommended. Use HE detergents only.

NOTE

Reducing the amount of detergent may reduce the quality of cleaning. It is important to pre-treat stains, sort carefully by color and soil level, and avoid overloading.

Washing a load of laundry

Features

Automatic dispenser

Your washer has separate compartments for dispensing detergent and color-safe bleach and fabric softener. Add all laundry additives to their respective compartments before starting your washer.

The automatic dispenser must always be in place before you start your washer.

DO NOT open the automatic dispenser when your washer is running.

NOTE

- Never exceed the manufacturer's recommendations when adding detergent.
- This compartment holds liquid detergent for the main wash cycle, which is added to the load at the beginning of the cycle.
- When using powdered detergent, remove the liquid detergent compartment from the detergent drawer. The washer will not dispense powdered detergent from the liquid detergent compartment.

To add detergent to the automatic dispenser:

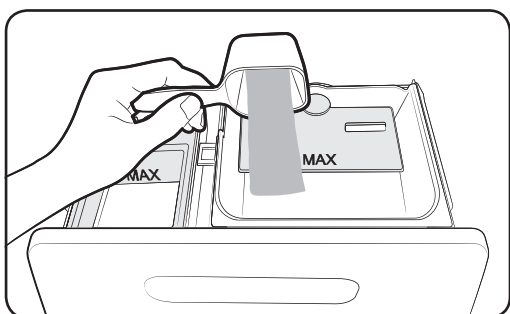

1. Open the dispenser drawer.
2. Load the recommended amount of liquid (or powder) detergent into the detergent compartment before you start your wash.
3. Close the drawer slowly and smoothly to avoid spilling, splashing, or premature dispensing of the contents.

NOTE

It is normal for a small amount of water to remain in the dispenser compartments at the end of the cycle.

NOTE

Do not put chlorine bleach in the dispenser drawer.

Loading the Liquid (or Powered) detergent compartment

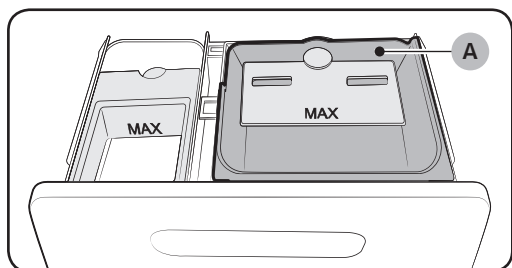

1. Pour the recommended amount of laundry detergent directly into the detergent compartment before starting your washer.
2. If you are using color-safe bleach, add it with the detergent to the detergent compartment.

NOTE

When adding color-safe bleach with detergent, it is best if both laundry products are in the same form - liquid.

NOTE

When using powdered detergent, remove the **liquid detergent compartment (A)** from the detergent drawer. The washer will not dispense powdered detergent from the liquid detergent compartment.

Washing a load of laundry

Loading the Bleach compartment

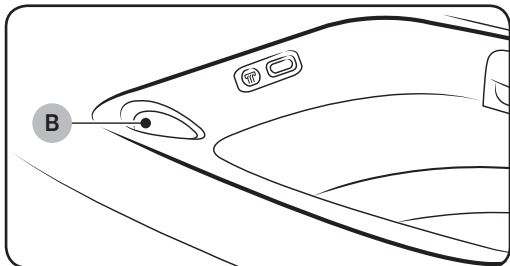

CAUTION

Use liquid chlorine bleach only.

1. Add chlorine bleach to the **bleach compartment (B)**. DO NOT overfill the bleach compartment.

NOTE

- Avoid splashing or over-filling the compartment.
- Never pour undiluted liquid chlorine bleach directly onto the load or into the tub. It is a powerful chemical and can cause fabric damage, such as weakening of the fibers or color loss, if not used properly.
- If you prefer to use color-safe, non-chlorine bleach, add it to the appropriate detergent compartment.
DO NOT pour color-safe bleach into the Bleach compartment.

Loading the fabric softener compartment

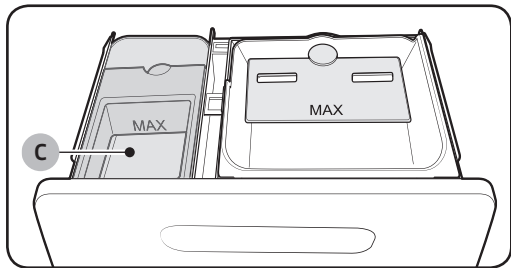

1. Pour the recommended amount of liquid fabric softener into the **softener compartment (C)**. For smaller loads, use less than one capful.
2. Dilute the fabric softener with water until it reaches MAX FILL in the compartment.
3. The dispenser automatically releases liquid fabric softener at the proper time during the rinse cycle.

NOTE

- Use the softener compartment **ONLY** for liquid fabric softeners.
- **DO NOT** use the Downy Ball* in the fabric softener compartment with this washer. It will not add fabric softener at the appropriate time. Use the detergent compartment. (* Brand names are trademarks of their respective manufacturers.)
- Do not use liquid fabric softener that is too thick or sticky. It may not mix with the water sufficiently.

Maintaining your washer

WARNING

The control board, heat sink, motor, inlet valve and pump are intentionally not grounded and may present a risk of electric shock only during servicing.

Cleaning the exterior

1. Turn off the water faucets after finishing the day's washing. This will shut off the water supply to your washer and prevent the unlikely possibility of damage from escaping water. Leave the lid open to allow the inside of your washer to dry out.
2. Use a soft cloth to wipe up all detergent, bleach, or other spills as they occur.
3. Clean the control panel with a soft, damp cloth. Do not use abrasive powders or cleaning pads. Do not spray cleaners directly on the panel.

Cleaning the interior

Clean the interior of your washer periodically to remove any dirt, soil, odor, mold, mildew, or bacterial residue that may remain in your washer as a result of washing clothes.

Failure to follow these instructions may result in unpleasant conditions, including odors and/or permanent stains on your washer or laundry.

Hard water deposits may be removed, if needed. Use cleaners labeled "Washer safe".

Storing your washer

Washers can be damaged if water is not removed from hoses and internal components before storage. Prepare your washer for storage as follows:

1. Select the Quick Wash cycle and add bleach to the automatic dispenser. Run your washer through the cycle without a load.
2. Turn the water faucets off and disconnect the inlet hoses.
3. Unplug your washer from the electrical outlet and leave your washer lid open to let air circulate inside the drum. If your washer has been stored in below-freezing temperatures, allow time for any leftover water in your washer to thaw out before use.

Protecting the top cover and the front frame

Do not place any heavy or sharp objects or a detergent box on the washer. They can scratch or damage the top cover of the unit.

NOTE

Since the entire washer has a high-gloss finish, the surface can be scratched or damaged. Avoid scratching or damaging the surface when using the washer.

Cleaning mesh filter

Clean the mesh filters in the water inlets once or twice a year.

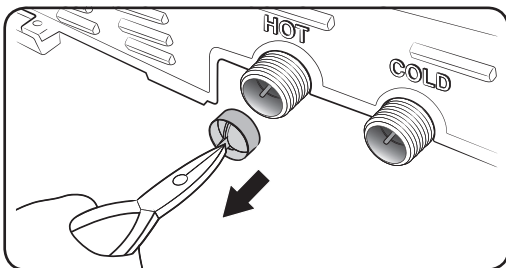
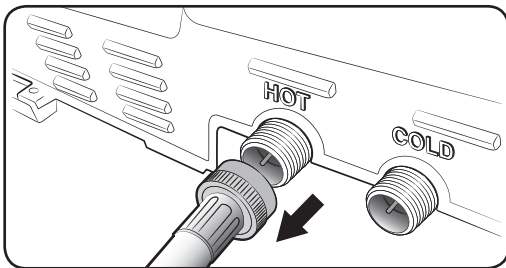

1. Turn off the washer, and then unplug the power cord.
2. Close the faucet.
3. Loosen and disconnect the water hoses from the back of the washer. Cover the hoses with a cloth or towel to prevent water from gushing out.
4. Use pliers to pull out the mesh filter from the inlet valve.
5. Submerge the mesh filter deeply in water so that the threaded connector is also submerged. Carefully remove any debris from the filter.
6. Dry the mesh filter completely in a shaded area.
7. Reinsert the mesh filter into the inlet valve, and reconnect the water hose to the inlet valve.
8. Open the faucet.

NOTE

If the mesh filter is clogged, the “4C” information code appears on the the washer’s display screen.

Cleaning the dispensers

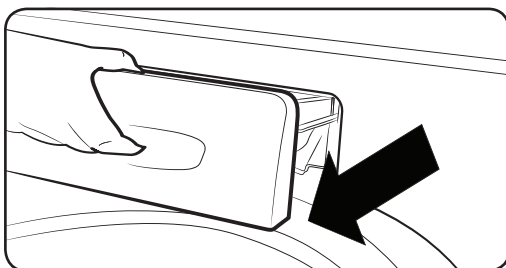

The automatic dispenser may need to be cleaned periodically due to laundry additive buildup.

1. Pull the dispenser drawer straight back until it stops.

Maintaining your washer

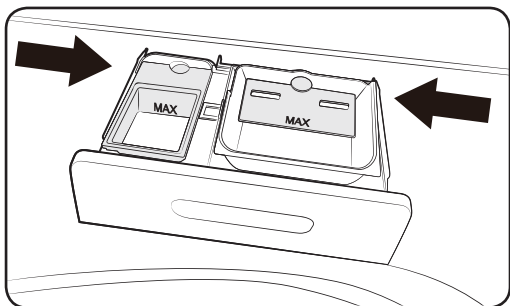

2. Push in both sides of the drawer at the back simultaneously. When you feel the sides move inward, pull out the dispenser drawer.

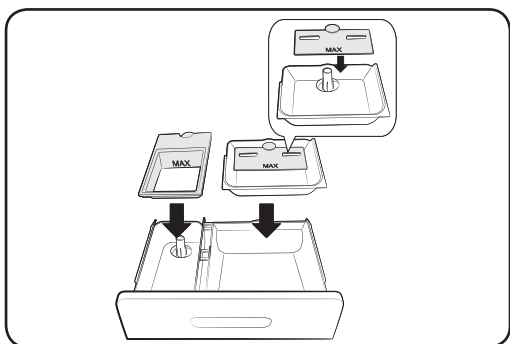

3. Remove the inserts from the 3 compartments. Rinse the inserts and the drawer with warm water to remove traces of accumulated laundry products.

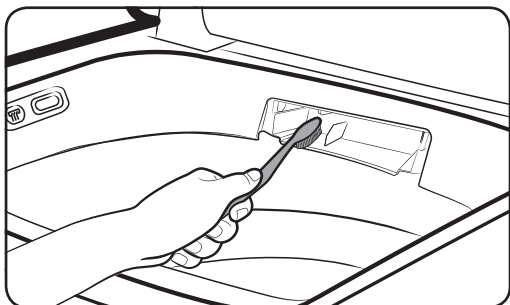

4. Use a small, non-metal brush (for example, a toothbrush) to clean the drawer opening and the recess. Remove all residue from the upper and lower parts of the recess.

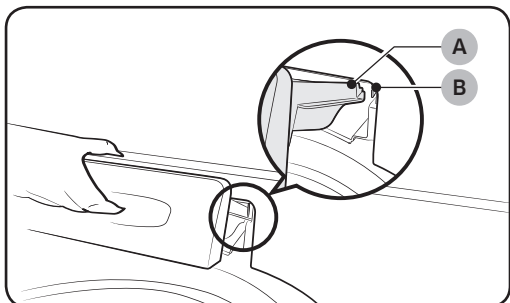

5. Return the inserts to their proper compartments, and then replace the drawer by placing the **dispenser drawer rail (B)** on top of the **compartment rail (A)** (To make this easier, tilt the dispenser drawer downward and insert it). Then push the drawer in firmly and slowly.

Self Clean

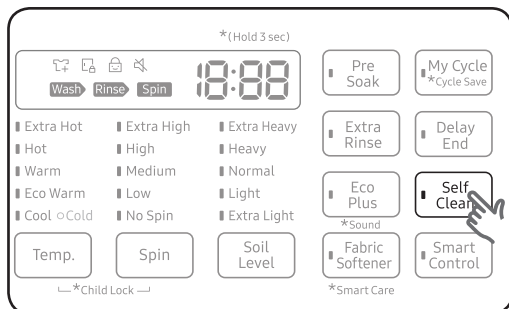

Self Clean is a self-cleaning cycle that removes mold that may occur inside the washer.

1. Press **POWER**.
2. Select **Self Clean**. Once **Self Clean** is selected, the only function that can be set is Delay End.
3. Press and hold **START/PAUSE**. The Self Clean cycle starts.

⚠ CAUTION

- Using Self Clean, you can clean the drum without using a cleansing agent.
- Never use Self Clean when laundry is in the washer. This may cause damage to the laundry or a problem with the washer.

📖 NOTE

The Self Clean Auto Led Function

- If the “**Self Clean**” LED is lit after a wash, it means that tub (drum) cleaning is required. Remove the laundry from the washing machine, turn the power on, and clean the drum by running Self Clean.
- If you do not run Self Clean, the “**Self Clean**” LED turns off. However, the “**Self Clean**” LED will light again after five washes. Not running **Self Clean** at this point will not cause a problem with the washing machine. However, we strongly recommend you run a Self Clean cycle as soon as possible to remove mold and prevent unpleasant odors.
- Although the Self Clean Auto LED lights once a month or so, the frequency may differ depending on the number of times the washing machine is used.

Troubleshooting

Checkpoints

If you encounter a problem with the washer, first check the table below and try the suggestions.

Problem	Action
Does not turn on.	<ul style="list-style-type: none">• Make sure your home electrical system is providing electrical power that matches the requirements of the washer. See page 19.• Make sure the power cord is completely plugged in.• Check the fuse or reset the circuit breaker.
Does not start.	<ul style="list-style-type: none">• Make sure the door is closed.• Make sure the water taps are open.• Make sure to press or tap START/PAUSE to start the washing machine.• Make sure Child Lock is not activated.• Before the washing machine starts to fill, it will make a series of clicking noises to check the door lock, and then does a quick drain.• Was the door opened during the spinning cycle? Close the door, and then press or tap START/PAUSE to resume.• The machine enters Standby or is in a soaking cycle. Please wait.• Check the fuse or reset the circuit breaker
Water is not supplied.	<ul style="list-style-type: none">• Make sure you press or tap START/PAUSE after selecting the cycle and options.• Make sure the water taps are open.• Are the mesh filters in the water inlets clogged? Clean the mesh filters by brushing with a toothbrush. See page 53.• Is the water supply cut off? If the water supply is cut off, close the tap and power off.• Straighten the water supply hoses.• Open and close the door, and then press or tap START/PAUSE.• If the water pressure is low, it takes longer to start washing.• If the water level is not as high as necessary or lower than expected, use the level selector to adjust the water level.
After a cycle, detergent remains in the automatic dispenser.	<ul style="list-style-type: none">• Make sure the washing machine is running with sufficient water pressure.• Make sure the detergent drawer is properly inserted.• Remove and clean the detergent drawer, and then try again.

Problem	Action
Vibrates excessively or makes noise.	<ul style="list-style-type: none"> • Make sure the washing machine is on a level floor. If the floor is not level, use the levelling feet to adjust the washing machine. • Make sure the washing machine is not contacting any other object. • Make sure the laundry load is balanced. • Make sure the laundry is spread evenly in the washing machine. Spread out the laundry evenly and start again. • Make sure the space around the washing machine is free of objects. • Humming is produced normally during operation. • Objects such as coins can cause noise. Remove these objects from the washing machine after washing is complete.
Stops.	<ul style="list-style-type: none"> • Plug the power cord into a live electrical outlet. • Check the fuse or reset the circuit breaker. • Close the door, and then press or tap START/PAUSE to start the washing machine. For your safety, the washing machine will not spin unless the door is closed. • Before the washing machine starts to fill, it will make a series of clicking noises to check the door lock, and then does a quick drain. • There may be a pause or soak period in the cycle. Wait briefly and the washing machine may start. • Make sure the inlet hose filters at the taps are not clogged. Periodically clean the filters. See page 53. • This problem can occur temporarily due to low voltage in your household electrical system. It will be resolved when the voltage returns to normal.

Troubleshooting

Problem	Action
Fills with the wrong temperature water.	<ul style="list-style-type: none"> Fully open both water taps. Make sure the temperature selection is correct. Make sure the hoses are connected to the correct water taps. Flush water lines. Disconnect the hoses and clean the mesh filters. The water inlet mesh filters may be clogged. See page 53. While the washing machine fills, the water temperature may change as the automatic temperature control feature checks incoming water temperature. This is normal. While the washing machine fills, you may notice just hot and/or just cold water going through the dispenser when cold or warm temperatures are selected. This is a normal function of the automatic temperature control feature as the washing machine determines the water temperature.
Door (Lid) locked or will not open.	<ul style="list-style-type: none"> While the washing machine is operating, press or tap START/PAUSE to stop the washing machine. It may take a few moments for the door lock mechanism to disengage.
Does not drain and/or spin.	<ul style="list-style-type: none"> Check the fuse or reset the circuit breaker. Make sure the electrical voltage is normal. Make sure the washing machine is plugged in. Make sure the drain hose is pointed downward. (Natural drain models only) Make sure the drain hose is not clogged. Make sure the drain hose is not kinked. Straighten the drain hose. If there is a drain restriction, call for service. Close the door, and then press or tap START/PAUSE. For your safety, the washing machine will not spin unless the door is closed.
Load is wet at the end of the cycle.	<ul style="list-style-type: none"> Use the High or Extra High spin speed cycle. (Applicable model only) Use high efficiency (HE) detergent to reduce oversudsing. The load is too small. Small loads (one or two items) may become unbalanced and not spin completely.



Problem	Action
Leaks water.	<ul style="list-style-type: none"> • Make sure all hose connections are tight. • Make sure the water supply hoses' rubber washers are in the correct position. Screw tightly again. • Make sure the end of the drain hose is correctly inserted and secured to the drain system. • Avoid overloading. • Use high efficiency (HE) detergent to prevent oversudsing. • Make sure the water supply hose is not kinked. • If the water supply pressure is too strong, water may leak. Close the water tap a little. • Make sure water is not leaking from the water tap. If it is, repair the water tap.
Excessive suds.	<ul style="list-style-type: none"> • Use high efficiency (HE) detergent to prevent oversudsing. • Reduce the detergent amount for soft water, small loads, or lightly soiled loads. • Non-HE detergent is not recommended.
The spin basket or drain/supply hose is frozen.	<ul style="list-style-type: none"> • Use warm water to disconnect the water supply hose and drain hose. Soak them in warm water. • Fill the spin basket with warm water, and then wait for about 10 minutes. • Put a hot towel on the drain hose connector. • Reconnect the water supply hose and drain hose, and then check if water is supplied properly.
Water drains out immediately.	<ul style="list-style-type: none"> • Make sure the drain hose is not clogged, and is hung over the drain hose hook. Fill the spin basket halfway with water, and try spinning again. • Lift the end of the drain hose to prevent water from draining. Fill the spin basket halfway with water, and then run the Spin cycle after releasing the drain hose. • Make sure the drain hose is installed correctly. See the installation section of this user manual and adjust the position of the drain hose as instructed.
Stains on clothes.	<ul style="list-style-type: none"> • Select an appropriate cycle for the laundry. Use the Heavy Duty cycle for stained clothes. • Apply a recommended amount of detergent as instructed by the detergent manufacturer. • Clean the magic filter (if it comes with your washer) on a regular basis.





Troubleshooting

Problem	Action
Has odors.	<ul style="list-style-type: none"> Excessive suds collect in recesses and can cause foul odors. Run a Self Clean cycle to sanitize periodically. Dry the washing machine interior after a cycle has finished.

If a problem persists, contact a local Samsung service center.

Information codes

The washer may display information codes to help you understand what is occurring with your washer better.

No	Code	Meaning
1	1C	<p>The Water Level sensor is not working properly.</p> <ul style="list-style-type: none"> Turn off the washer, unplug it, wait 30 seconds, and then plug the washer in again. If the information code remains, contact a Samsung customer service center. <p> NOTE If the washer displays "1C", the washer will automatically drain for 3 minutes. During this time, the POWER button is inoperative.</p>
2	3C	<p>Check the motor for operation.</p> <ul style="list-style-type: none"> Try restarting the cycle. If the problem continues, call for service.
3	4C	<p>Water is not supplied.</p> <ul style="list-style-type: none"> Make sure the water taps are open. Make sure the water hoses are not clogged. Make sure the water taps are not frozen. Make sure the washing machine is operating with sufficient water pressure. Make sure that the cold water tap and the hot water tap are properly connected. Clean the mesh filter as it may be clogged. <p> NOTE If the washer displays "4C", the washer will automatically drain for 3 minutes. During this time, the POWER button is inoperative.</p>
4	4C2	<ul style="list-style-type: none"> Make sure the cold water supply hose is firmly connected to the cold water tap. If it is connected to the hot water tap, laundry may be damaged when some cycles are run.

No	Code	Meaning
5	5C	<p>Water is not draining.</p> <ul style="list-style-type: none"> • Make sure the drain hose is not frozen or clogged. • Make sure the drain hose is positioned correctly, depending on the connection type. • Clean the mesh debris filter as it may be clogged. • Make sure the drain hose is straight all the way to the drain system. • Turn off the washer, unplug it, wait one minute, and then plug the washer in again. If the information code remains, contact a Samsung customer service center.
6	9C1	<p>The electronic control needs to be checked (Over Voltage Error).</p> <ul style="list-style-type: none"> • Check if power is supplied properly. • Turn off the washer, unplug it, wait one minute, and then plug the washer in again. If the information code remains, contact a Samsung customer service center.
7	9C2	<p>Low voltage detected.</p> <ul style="list-style-type: none"> • Check if the power cord is plugged in. • Turn off the washer, unplug it, wait one minute, and then plug the washer in again. If the information code remains, contact a Samsung customer service center.
8	AC6	<p>Inverter Communication problem.</p> <ul style="list-style-type: none"> • Turn off the washer, unplug it, wait one minute, and then plug the washer in again. If the information code remains, contact a Samsung customer service center.
9	dC	<p>Operating the washer with the door open.</p> <ul style="list-style-type: none"> • Make sure the door is properly closed. • Make sure laundry is not caught in the door.
10	HC	<p>High temperature heating check.</p> <ul style="list-style-type: none"> • Turn off the washer, unplug it, wait one minute, and then plug the washer in again. If the information code remains, contact a Samsung customer service center.

Troubleshooting

No	Code	Meaning
11	LC	<p>Check the drain hose.</p> <ul style="list-style-type: none"> • Make sure the end of the drain hose is positioned correctly. • Make sure the drain hose is not clogged. • Turn off the washer, unplug it, wait one minute, and then plug the washer in again. If the information code remains, contact a Samsung customer service center. <p> NOTE</p> <p>When the washer displays “LC”, the washer do draining for 3 minutes. During this time, the POWER button is inoperative.</p>
12	OC	<p>Water overflowed.</p> <ul style="list-style-type: none"> • Restart after spinning. • Turn off the washer, unplug it, wait one minute, and then plug the washer in again. If the information code remains, contact a Samsung customer service center.
13	PC	<p>When position of the clutch can't be detected.</p> <ul style="list-style-type: none"> • Turn off the washer, unplug it, wait one minute, and then plug the washer in again. If the information code remains, contact a Samsung customer service center.
14	PC1	<p>After position of the clutch is detected, if the signal from the hall clutch hall is incorrect.</p> <ul style="list-style-type: none"> • Turn off the washer, unplug it, wait one minute, and then plug the washer in again. If the information code remains, contact a Samsung customer service center.
15	Ub	<p>Spinning does not work.</p> <ul style="list-style-type: none"> • Make sure laundry is spread out evenly. • Make sure the washing machine is on a flat, stable surface. • Redistribute the load. If only one item of clothing needs washing, such as a bathrobe or pair of jeans, the final spin result might be unsatisfactory, and an “Ub” check message will appear in the display.
16	Ur	<p>Display for additional rinsing.</p> <ul style="list-style-type: none"> • Show additional rinsing in sensing unbalance. • Method of releasing the display. <ul style="list-style-type: none"> • Any key input.





For any codes not listed above, call 1-800-726-7864 (1-800-SAMSUNG).

Specifications

Fabric care chart

The following symbols provide garment care direction. The clothing care labels include symbols for drying, bleaching, drying and ironing, or dry cleaning when necessary. The use of symbols ensures consistency among garment manufacturers of domestic and imported items. Follow care label directions to optimize garment life and reduce laundering problems.

Wash cycle

	Normal
	Permanent press/Wrinkle resistant/Wrinkle control
	Gentle/Delicates
	Hand wash

Water temperature



•••	Hot
••	Warm
•	Cold

NOTE



This represents appropriate wash water temperatures for various items. The temperature range for Hot is 105° - 125 °F / 41° - 52 °C, for Warm 85° - 105 °F / 29° - 41 °C, and for Cold 60° - 85 °F / 16° - 29 °C. (Wash water temperature must be a minimum of 60 °F / 16 °C for detergent activation and effective cleaning.)

The clothes washer can not ensure these temperatures because the actual temperature of the water entering your washer depends on water heater settings and regional water supply temperatures. For example, cold water entering the home in the northern states during winter may be 40 °F / 4 °C which is too cold for effective cleaning. In this situation, you will need to adjust the water temperature by selecting a warm setting, adding some hot water to the MAX FILL line, or using your washer's heating option, if available.



Bleach

	Any bleach (when needed)
	Only non-chlorine (color-safe) bleach (when needed)
	Tumble dry

Normal





	Permanent press/Wrinkle resistant/Wrinkle control
	Gentle/Delicates

Special instructions





	Line dry/Hang to dry
	Drip dry
	Dry flat

Specifications



Heat setting

	High
	Medium
	Low
	Any heat
	No heat / Air







Dry-clean

	Dry-clean
	Do not dry-clean
	Line dry / Hang to dry
	Drip dry
	Dry flat

Iron dry or steam temperatures

	High
	Medium
	Low

Warning symbols for laundering

	Do not wash
	Do not wring
	Do not bleach
	Do not tumble dry
	No steam (added to iron)
	Do not iron

Helping the environment

- Your washer is manufactured from recyclable materials. If you decide to dispose of it, please observe local waste disposal regulations. Cut off the power cord so that the appliance cannot be connected to a power source. Remove the lid so that animals and small children cannot get trapped inside the appliance.
- Do not exceed the detergent quantities recommended in the detergent manufacturers' instructions.
- Use stain removal products and bleaches before the wash cycle only when necessary.
- Save water and electricity by only washing full loads (the exact amount depends upon the program used).

Declaration of conformity

This appliance complies with UL2157.

Specifications

Specification sheet

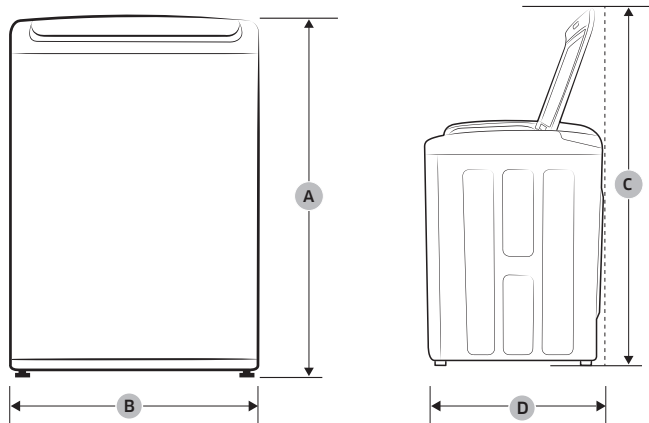

Type		Top loading washer	
Model name		WA54M8750A*	
Dimensions (inches (cm))	A. Height	42.4 (107.7)	
	B. Width	27.0 (68.6)	
	C. Height with lid open	61.0 (155.0)	
	D. Depth	29.3 (74.4)	
Water pressure (psi (kPa))		20 - 116 (137 - 800)	
Spin revolution		800 rpm	
NET weight (kg (lb))		62 (137.0)	
Heater rating	Washing	120 V	700 W
	Spin	120 V	400 W
	Drain	120 V	80 W

Cycle chart

Use this chart to set the best cycle and options for you laundry.

NOTE

Setting	Temp.	Spin	Soil Level
●: factory setting	EH: Extra Hot	EH: Extra High	EH: Extra Heavy
●: can be selected	H: Hot	H: High	H: Heavy
	W: Warm	M: Medium	N: Normal
	EW: Eco warm	L: Low	L: Light
	C: Cool	NS: No Spin	EL: Extra Light
	CD: Cold		

Cycle	Temp.						Spin					Soil Level				
	EH	H	W	EW	C	CD	EH	H	M	L	NS	EH	H	N	L	EL
NORMAL	●	●	●	●	●	●	●	●	●	-	●	●	●	●	●	●
HEAVY DUTY	-	●	●	●	●	●	●	●	●	●	●	●	●	●	●	●
SUPER SPEED	-	●	●	●	●	●	●	●	●	●	●	●	●	●	●	●
DEEP WASH	-	●	●	●	●	●	●	●	●	●	●	●	●	●	●	●
DELICATES	-	-	●	●	●	●	-	-	●	●	●	-	-	-	-	●
BRILLIANT WHITES	-	●	●	●	●	●	●	●	●	●	●	●	●	●	●	●
BEDDING/ WATERPROOF	-	●	●	●	●	●	-	●	●	●	●	●	●	●	●	●
PERM PRESS	-	●	●	●	●	●	●	●	●	●	●	●	●	●	●	●
QUICK WASH	-	●	●	●	●	●	●	●	●	●	●	●	●	●	●	●
STEAM SANITIZE	●	-	-	-	-	-	●	●	●	●	●	●	●	●	●	●
RINSE+SPIN	-	-	-	-	-	-	●	●	●	●	●	-	-	-	-	-
SPIN	-	-	-	-	-	-	●	●	●	●	●	-	-	-	-	-
SELF CLEAN	-	●	-	-	-	-	-	-	●	-	-	-	-	-	-	-

Specifications

Cycle	Options			
	Pre Soak	Extra Rinse	Eco Plus	Fabric Softener
NORMAL	●	●	●	●
HEAVY DUTY	●	●	●	●
SUPER SPEED	-	●	-	●
DEEP WASH	●	●	●	●
DELICATES	-	●	-	●
BRILLIANT WHITES	●	●	●	●
BEDDING/ WATERPROOF	●	●	-	●
PERM PRESS	●	●	●	●
QUICK WASH	-	●	-	●
STEAM SANITIZE	●	●	-	●
RINSE+SPIN	-	●	-	●
SPIN	-	-	-	-
SELF CLEAN	-	-	-	-

Warranty (U.S.A)

SAMSUNG WASHER

LIMITED WARRANTY TO ORIGINAL PURCHASER

This SAMSUNG brand product, as supplied and distributed by SAMSUNG ELECTRONICS AMERICA, INC. (SAMSUNG) and delivered new, in the original carton to the original consumer purchaser, is warranted by SAMSUNG against manufacturing defects in materials and workmanship for a limited warranty period of:

One (1) year part and labor, Three (3) years stainless tub part (Part Only), Ten (10) years washing DD motor part (Part Only).

This limited warranty begins on the original date of purchase, and is valid only on products purchased and used in the United States. To receive warranty service, the purchaser must contact SAMSUNG for problem determination and service procedures. Warranty service can only be performed by a SAMSUNG authorized service center. The original dated bill of sale must be presented upon request as proof of purchase to SAMSUNG or SAMSUNG's authorized service center. SAMSUNG will provide in-home service during the warranty period at no charge, subject to availability within the contiguous United States. In-home service is not available in all areas.

To receive in-home service, product must be unobstructed and accessible to the service agent. If service is not available, SAMSUNG may elect to provide transportation of the product to and from an authorized service center.

SAMSUNG will repair, replace, or refund this product at our option and at no charge as stipulated herein, with new or reconditioned parts or products if found to be defective during the limited warranty period specified above. All replaced parts and products become the property of SAMSUNG and must be returned to SAMSUNG. Replacement parts and products assume the remaining original warranty, or ninety (90) days, whichever is longer. This limited warranty covers manufacturing defects in materials and workmanship encountered in normal, noncommercial use of this product and shall not apply to the following: damage that occurs in shipment; delivery and installation; applications and uses for which this product was not intended; altered product or serial numbers; cosmetic damage or exterior finish; accidents, abuse, neglect, fire, water, lightning, or other acts of nature or God; use of products, equipment, systems, utilities, services, parts, supplies, accessories, applications, installations, repairs, external wiring or connectors not supplied or authorized by SAMSUNG that damage this product or result in service problems; incorrect electrical line voltage, fluctuations and surges; customer adjustments and failure to follow operating instructions, maintenance and environmental instructions that are covered and prescribed in the instruction book; product removal and reinstallation; problems caused by pest infestations.

Warranty (U.S.A)

This limited warranty does not cover problems resulting from incorrect electric current, voltage or supply, light bulbs, house fuses, house wiring, cost of a service call for instructions, or fixing installation errors. SAMSUNG does not warrant uninterrupted or error-free operation of the product.

EXCEPT AS SET FORTH HEREIN, THERE ARE NO WARRANTIES ON THIS PRODUCT EITHER EXPRESS OR IMPLIED, AND SAMSUNG DISCLAIMS ALL WARRANTIES INCLUDING, BUT NOT LIMITED TO, ANY IMPLIED WARRANTIES OF MERCHANTABILITY, INFRINGEMENT OR FITNESS FOR A PARTICULAR PURPOSE.

NO WARRANTY OR GUARANTEE GIVEN BY ANY PERSON, FIRM, OR CORPORATION WITH RESPECT TO THIS PRODUCT SHALL BE BINDING ON SAMSUNG. SAMSUNG SHALL NOT BE LIABLE FOR LOSS OF REVENUE OR PROFITS, FAILURE TO REALIZE SAVINGS OR OTHER BENEFITS, OR ANY OTHER SPECIAL, INCIDENTAL OR CONSEQUENTIAL DAMAGES CAUSED BY THE USE, MISUSE, OR INABILITY TO USE THIS PRODUCT, REGARDLESS OF THE LEGAL THEORY ON WHICH THE CLAIM IS BASED, AND EVEN IF SAMSUNG HAS BEEN ADVISED OF THE POSSIBILITY OF SUCH DAMAGES.

NOR SHALL RECOVERY OF ANY KIND AGAINST SAMSUNG BE GREATER IN AMOUNT THAN THE PURCHASE PRICE OF THE PRODUCT SOLD BY SAMSUNG AND CAUSING THE ALLEGED DAMAGE.

WITHOUT LIMITING THE FOREGOING, PURCHASER ASSUMES ALL RISK AND LIABILITY FOR LOSS, DAMAGE, OR INJURY TO PURCHASER AND PURCHASER'S PROPERTY AND TO OTHERS AND THEIR PROPERTY ARISING OUT OF THE USE, MISUSE, OR INABILITY TO USE THIS PRODUCT. THIS LIMITED WARRANTY SHALL NOT EXTEND TO ANYONE OTHER THAN THE ORIGINAL PURCHASER OF THIS PRODUCT, IS NONTRANSFERABLE AND STATES YOUR EXCLUSIVE REMEDY.

Some states do not allow limitations on how long an implied warranty lasts, or the exclusion or limitation of incidental or consequential damages, so the above limitations or exclusions may not apply to you. This warranty gives you specific rights, and you may also have other rights, which vary from state to state.

To obtain warranty service, please contact SAMSUNG at:
Samsung Electronics America, Inc.
85 Challenger Road
Ridgefield Park, NJ 07660
1-800-SAMSUNG (726-7864)
www.samsung.com/us/support

Visits by a Service Engineer to explain functions, maintenance or installation are not covered by warranty.
Please contact your Samsung call agent for help with any of these issues.

Warranty (CANADA)

SAMSUNG WASHER

LIMITED WARRANTY TO ORIGINAL PURCHASER

This SAMSUNG brand product, as supplied and distributed by SAMSUNG ELECTRONICS CANADA, INC. (SAMSUNG) and delivered new, in the original carton to the original consumer purchaser, is warranted by SAMSUNG against manufacturing defects in materials and workmanship for a limited warranty period of:

One (1) year part and labor, Ten (10) years washing DD motor (Part only).

This limited warranty begins on the original date of purchase, and is valid only on products purchased and used in the Canada. To receive warranty service, the purchaser must contact SAMSUNG for problem determination and service procedures. Warranty service can only be performed by a SAMSUNG authorized service center. The original dated bill of sale must be presented upon request as proof of purchase to SAMSUNG or SAMSUNG's authorized service center. SAMSUNG will provide in-home service during the warranty period at no charge, subject to availability within the Canada. In-home service is not available in all areas.

To receive in-home service, product must be unobstructed and accessible to the service agent. If service is not available, SAMSUNG may elect to provide transportation of the product to and from an authorized service center.

SAMSUNG will repair, replace, or refund this product at our option and at no charge as stipulated herein, with new or reconditioned parts or products if found to be defective during the limited warranty period specified above. All replaced parts and products become the property of SAMSUNG and must be returned to SAMSUNG. Replacement parts and products assume the remaining original warranty, or ninety (90) days, whichever is longer. This limited warranty covers manufacturing defects in materials and workmanship encountered in normal, noncommercial use of this product and shall not apply to the following: damage that occurs in shipment; delivery and installation; applications and uses for which this product was not intended; altered product or serial numbers; cosmetic damage or exterior finish; accidents, abuse, neglect, fire, water, lightning, or other acts of nature or God; use of products, equipment, systems, utilities, services, parts, supplies, accessories, applications, installations, repairs, external wiring or connectors not supplied or authorized by SAMSUNG that damage this product or result in service problems; incorrect electrical line voltage, fluctuations and surges; customer adjustments and failure to follow operating instructions, maintenance and environmental instructions that are covered and prescribed in the instruction book; product removal and reinstallation; problems caused by pest infestations.

This limited warranty does not cover problems resulting from incorrect electric current, voltage or supply, light bulbs, house fuses, house wiring, cost of a service call for instructions, or fixing installation errors. SAMSUNG does not warrant uninterrupted or error-free operation of the product.

EXCEPT AS SET FORTH HEREIN, THERE ARE NO WARRANTIES ON THIS PRODUCT EITHER EXPRESS OR IMPLIED, AND SAMSUNG DISCLAIMS ALL WARRANTIES INCLUDING, BUT NOT LIMITED TO, ANY IMPLIED WARRANTIES OF MERCHANTABILITY, INFRINGEMENT OR FITNESS FOR A PARTICULAR PURPOSE.

NO WARRANTY OR GUARANTEE GIVEN BY ANY PERSON, FIRM, OR CORPORATION WITH RESPECT TO THIS PRODUCT SHALL BE BINDING ON SAMSUNG. SAMSUNG SHALL NOT BE LIABLE FOR LOSS OF REVENUE OR PROFITS, FAILURE TO REALIZE SAVINGS OR OTHER BENEFITS, OR ANY OTHER SPECIAL, INCIDENTAL OR CONSEQUENTIAL DAMAGES CAUSED BY THE USE, MISUSE, OR INABILITY TO USE THIS PRODUCT, REGARDLESS OF THE LEGAL THEORY ON WHICH THE CLAIM IS BASED, AND EVEN IF SAMSUNG HAS BEEN ADVISED OF THE POSSIBILITY OF SUCH DAMAGES.

NOR SHALL RECOVERY OF ANY KIND AGAINST SAMSUNG BE GREATER IN AMOUNT THAN THE PURCHASE PRICE OF THE PRODUCT SOLD BY SAMSUNG AND CAUSING THE ALLEGED DAMAGE. WITHOUT LIMITING THE FOREGOING, PURCHASER ASSUMES ALL RISK AND LIABILITY FOR LOSS, DAMAGE, OR INJURY TO PURCHASER AND PURCHASER'S PROPERTY AND TO OTHERS AND THEIR PROPERTY ARISING OUT OF THE USE, MISUSE, OR INABILITY TO USE THIS PRODUCT. THIS LIMITED WARRANTY SHALL NOT EXTEND TO ANYONE OTHER THAN THE ORIGINAL PURCHASER OF THIS PRODUCT, IS NONTRANSFERABLE AND STATES YOUR EXCLUSIVE REMEDY.

Some provinces do not allow limitations on how long an implied warranty lasts, or the exclusion or limitation of incidental or consequential damages, so the above limitations or exclusions may not apply to you. This warranty gives you specific rights, and you may also have other rights, which vary from province to province.

Warranty (CANADA)

To obtain warranty service, please contact SAMSUNG at:

Samsung Electronics Canada Inc.

2050 Derry Road West

Mississauga, Ontario L5N 0B9 Canada

1-800-SAMSUNG (726-7864)

www.samsung.com/ca/support (English)

www.samsung.com/ca_fr/support (French)

Visits by a Service Engineer to explain functions, maintenance or installation are not covered by warranty.

Please contact your Samsung call agent for help with any of these issues.

Memo

SAMSUNG

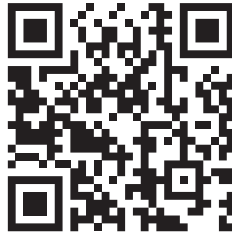

Scan the QR code* or visit
www.samsung.com/spsn
to view our helpful
How-to Videos and Live Shows

*Requires reader to be installed on your smartphone

Scan this with your smartphone

QUESTIONS OR COMMENTS?

COUNTRY	CALL	OR VISIT US ONLINE AT
U.S.A - Consumer Electronics - Mobile Phones	1-800-SAMSUNG (726-7864) 1-844-SAM-PAYS (726-7297)	www.samsung.com/us/support
CANADA	1-800-SAMSUNG(726-7864) 1-844-SAM-PAYS (726-7297)	www.samsung.com/ca/support (English) www.samsung.com/ca_fr/support (French)



DC68-03774B-02