

OWNER'S MANUAL

2023 CRF450R/RX/RWE

This manual should be considered a permanent part of the vehicle and should remain with the vehicle when it is resold.

This publication includes the latest production information available before printing. Honda Motor Co., Ltd. reserves the right to make changes at any time without notice and without incurring any obligation.

No part of this publication may be reproduced without written permission.

The vehicle pictured in this owner's manual may not match your actual vehicle.

IMPORTANT NOTICE

FOR COMPETITION USE ONLY

This vehicle is designed, manufactured and sold for closed-course competition use only. It does not conform to Federal Motor Vehicle Safety Standards or U.S. EPA Noise and Emission Standards. Operation on public streets, roads, highways or for off-road recreation is illegal.

State and federal laws prohibit operation of this vehicle except in an organized racing or competitive event on a closed course, or by permit issued by the local governmental jurisdiction. This vehicle is sold "as is" with no warranties.

FOR EXPERIENCED RIDERS, NO PASSENGERS

This vehicle is designed as an operator-only vehicle and for use by experienced riders only. The load limit and seating configuration do not safely permit the carrying of a passenger.

Welcome

Congratulations on your purchase of a new Honda vehicle. Your selection of a Honda makes you part of a worldwide family of satisfied customers who appreciate Honda's reputation for building quality into every product.

Your vehicle is a high performance racing motorcycle that utilizes the latest off-road racing/motocross technology and is intended for competition use in sanctioned, closed-course events by experienced riders only.

Be aware that off-road racing/motocross is a physically demanding sport that requires more than just a fine vehicle. To do well, you must be in excellent physical condition and be a skillful rider. For the best results, work diligently on your physical conditioning and practice frequently.

To ensure your safety and riding pleasure:

- Read this owner's manual and competition handbook carefully.
- Follow all recommendations and procedures contained in this owner's manual and competition handbook.
- Pay close attention to safety messages contained in this owner's manual, competition handbook, and on the vehicle.

To protect your investment, we urge you to take responsibility for keeping your vehicle well-serviced and maintained. Also, observe the break-in guidelines and always perform the pre-ride inspection and other periodic checks in this manual.

When service is required, remember that your Honda dealer knows your vehicle best. If you have the required mechanical “know-how” and tools, you can purchase an official Honda Service Manual to help you perform many maintenance and repair tasks. ➤ P. 68

You may also want to visit our website at www.powersports.honda.com.

Canada www.honda.ca.

Happy riding!

A Few Words About Safety

Your safety, and the safety of others, is very important. Operating this vehicle safely is an important responsibility.

To help you make informed decisions about safety, we have provided operating procedures and other information on safety labels in this owner's manual, and competition handbook. This information alerts you to potential hazards that could hurt you or others.

Of course, it is not practical or possible to warn you about all hazards associated with operating or maintaining a vehicle. You must use your own good judgment.

You will find important safety information in a variety of forms, including:

- Safety labels on the vehicle
- Safety Messages preceded by a safety alert symbol  and one of three signal words: DANGER, WARNING, or CAUTION.

These signal words mean:

DANGER

You **WILL** be **KILLED** or **SERIOUSLY HURT** if you don't follow instructions.

WARNING

You **CAN** be **KILLED** or **SERIOUSLY HURT** if you don't follow instructions.

CAUTION

You **CAN** be **HURT** if you don't follow instructions.

Other important information is provided under the following titles:

NOTICE Information to help you avoid damage to your vehicle, other property, or the environment.

Contents

Vehicle Safety P. 2

Operation Guide P. 12

Maintenance P. 31

Troubleshooting P. 51

Information P. 57

Specifications P. 71

Vehicle Safety

This section contains important information for safe riding of your vehicle.
Please read this section carefully.

Safety Guidelines.....	P. 3
Safety Labels.....	P. 6
Safety Precautions.....	P. 7
Riding Precautions	P. 8
Accessories & Modifications.....	P. 11

Safety Guidelines

Follow these guidelines to enhance your safety:

- Perform all routine and regular inspections specified in this owner's manual and competition handbook.
- Stop the engine and keep sparks and flames away before filling the fuel tank.
- Do not run the engine in enclosed or partly enclosed areas. Carbon monoxide in exhaust gases is toxic and can kill you.

Always Wear a Helmet

It's a proven fact: helmets and protective apparel significantly reduce the number and severity of head and other injuries. So always wear an approved helmet and protective apparel. ➤ P. 7

Before Riding

Make sure that you are physically fit, mentally focused, and free of alcohol and drugs. Check that you are wearing an approved helmet and protective apparel.

Take Time to Get to Know Your Vehicle

Because every vehicle is unique, take time to become thoroughly familiar with how this one operates and responds to your commands before placing your machine, and yourself, in competition.

Ride within Your Limits

Never ride beyond your personal abilities or faster than conditions warrant. Fatigue and inattention can impair your ability to use good judgment and ride safely.

Never Carry a Passenger

There are no handholds, seat, or footrests to carry a passenger.

Don't Drink or Use Drugs and Ride

Alcohol or drugs and riding don't mix. Even one alcoholic drink can reduce your ability to respond to changing conditions, and your reaction time gets worse with every additional drink. The same is true for drug use. Don't drink or use and ride, and don't let your friends do it either.

Keep Your Honda in Safe Condition

Maintaining your vehicle properly is critical to your safety. A loose bolt, for example, can cause a breakdown in which you can be seriously injured.

Lithium-Ion (Li-Ion) Battery

If you smell an unusual odor coming from the lithium-ion (li-ion) battery, park your vehicle in a safe place outside and away from flammable objects, then stop the engine. Have your vehicle inspected by your dealer immediately.

Carbon Monoxide Hazard

Exhaust contains poisonous carbon monoxide, a colorless, odorless gas. Breathing carbon monoxide can cause loss of consciousness and may lead to death.

If you run the engine in a confined or even partly enclosed area, the air you breathe could contain a dangerous amount of carbon monoxide.

Never run your vehicle inside a garage or other enclosure.

WARNING

Running the engine of your vehicle while in an enclosed or even partially enclosed area can cause a rapid build-up of toxic carbon monoxide gas.

Breathing this colorless, odorless gas can quickly cause unconsciousness and lead to death.

Only run your vehicle's engine when it is located in a well ventilated area outdoors.

Safety Labels

Safety and information labels on your vehicle provide important safety information and may warn you of potential hazards that could cause

serious injury. Read these labels carefully and don't remove them.

If a label comes off or becomes hard to read, contact your dealer for a replacement.

AVIS IMPORTANT
 Conducteur seulement. Aucun passager.
 Cette motocyclette est vendue sans garantie. L'acheteur prend tous les risques tant qu'à la performance et la qualité.
 Lire le manuel du propriétaire.
 CE VEHICULE A ETÉ CONÇU ET FABRIQUÉ POUR ÊTRE EMPLOYÉ LORS DE COMPÉTITIONS SEULEMENT. NON CONFORME AUX NORMES FÉDÉRALES DE SÉCURITÉ DES VEHICULES AUTOMOBILES OU LES NORMES AMÉRICAINES EPA ANTIPOLLUTION ET ANTIBRUIT DE MOTOCYCLETTE.
 L'utilisation sur les rues, routes, autoroutes publique ou hors route à des fins récréatives est illégale. Les lois provinciales et fédérales interdisent l'utilisation de ce véhicule sauf lors de courses organisées ou événements compétitifs sur circuit fermé. Ou par l'obtention d'un permis d'une agence gouvernementale locale ayant juridiction.

For Canada

IMPORTANT INFORMATION



Operator only. No passengers. This Honda Motorcycle is sold as is without warranty, and the entire risk as to quality and performance is with the buyer. Read owner's manual.
 THIS MOTORCYCLE IS DESIGNED FOR CLOSED COURSE COMPETITION USE ONLY.
 IT DOES NOT CONFORM TO FEDERAL MOTOR VEHICLE SAFETY STANDARDS, U.S. EPA MOTORCYCLE NOISE STANDARDS OR U.S. EPA EMISSION STANDARDS.
 Operation on public streets, roads, highways or for off-road recreation is illegal. State and Federal laws prohibit operation of this vehicle except in an organized racing or competitive event on a closed course or by permit issued by the local governmental agency having jurisdiction.

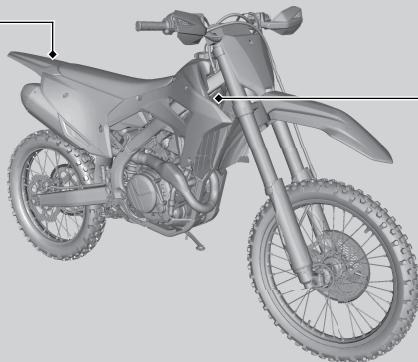

Safety Precautions

Protective Apparel

Make sure that you are wearing an approved helmet, eye protection, and other appropriate riding gear.

■ Helmet

Should be safety-standard certified, high-visibility, and the correct size for your head.

- Must fit comfortably but securely, with the chin strap fastened
- Approved eye protection

USA Look for a DOT (Department of Transportation) certification label on any helmet you buy.

⚠WARNING

Not wearing a helmet increases the chance of serious injury or death in a crash.

Make sure that you always wear an approved helmet, eye protection, and protective apparel.

■ Protective Gear

Whether you're practicing to improve your skills, or riding in competition, always wear an approved helmet, eye protection, and proper protective gear.

Riding Precautions

Break-in Period

During the first operating day or 15 miles (25 km) of running, follow these guidelines to ensure your vehicle's future reliability and performance.

- Avoid full-throttle starts and rapid acceleration.
- Avoid hard braking and rapid down-shifts.
- Ride conservatively.

This same procedure should be followed each time when:

- Piston is replaced
- Piston rings are replaced
- Cylinder is replaced
- Crankshaft or crank bearings are replaced

Parking

CRF450RX

- Park on a firm, level surface.
- If you must park on a slight incline or loose surface, park so that the vehicle cannot move or fall over.
- Make sure that high-temperature parts cannot come into contact with flammable materials.
- Do not touch the engine, muffler, brakes and other high-temperature parts until they cool down.

■ Parking with the Side Stand

1. Stop the engine.
2. Push the side stand down.
3. Slowly lean the vehicle to the left until its weight rests on the side stand.
4. Turn the handlebar fully to the left.
 - ▶ Turning the handlebar to the right reduces stability and may cause the vehicle to fall.

Refueling and Fuel Guidelines

Follow these guidelines to protect the engine and fuel system:

- Use only unleaded gasoline.
- Use the recommended octane number.
Using lower octane gasoline will result in decreased engine performance.
- Do not use fuels containing a high concentration of alcohol. ➤ P. 67
- Do not use stale or contaminated gasoline or an oil/gasoline mixture.
- Avoid getting dirt or water in the fuel tank.

Honda Selectable Torque Control

When the Honda Selectable Torque Control detects rear wheel spin during acceleration, the system will limit the amount of torque applied to the rear wheel based on the Torque Control level selected.

Rear wheel spin during acceleration is reduced at the higher Torque Control level setting. Select a level that is appropriate for your skill and riding conditions.

Torque Control does not work during deceleration and will not prevent the rear wheel from skidding due to engine braking. Do not close the throttle suddenly, especially when riding on slippery surfaces.

Torque Control may not compensate for rough track conditions or rapid throttle operation. Always consider track and weather conditions,

as well as your skills and condition, when applying throttle.

Always use the recommended tires and sprockets to ensure correct Torque Control operation.

Accessories & Modifications

We strongly advise that you do not add any accessories that were not specifically designed or approved for your vehicle by Honda or make modifications to your vehicle from its original design. Doing so can make it unsafe.

⚠️ WARNING

Improper accessories or modifications can cause a crash in which you can be seriously hurt or killed.

Follow all instructions in this owner's manual regarding accessories and modifications.

Do not pull a trailer with, or attach a sidecar to, your vehicle. Your vehicle was not designed for these attachments, and their use can seriously impair your vehicle's handling.

Do not attempt modify the vehicle to carry a passenger. The subframe was not designed to carry the additional weight of a passenger.

Parts Location

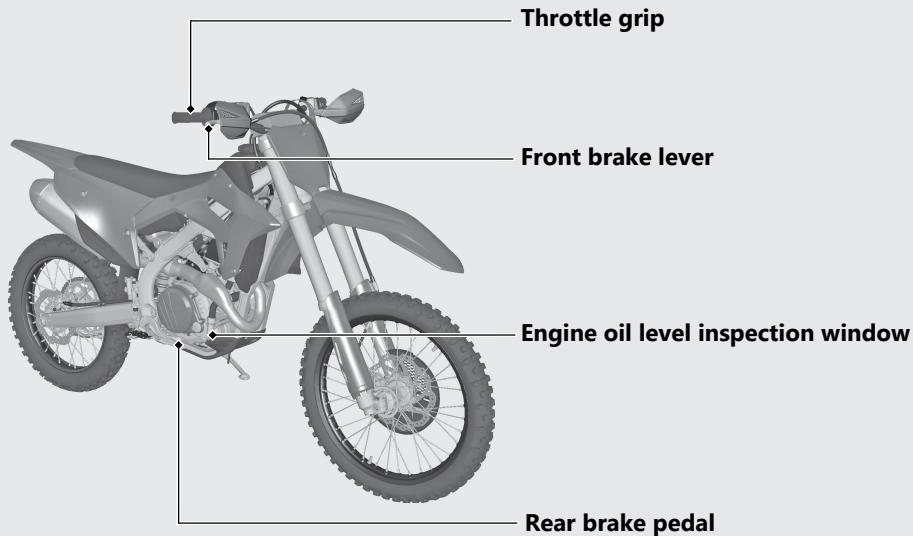

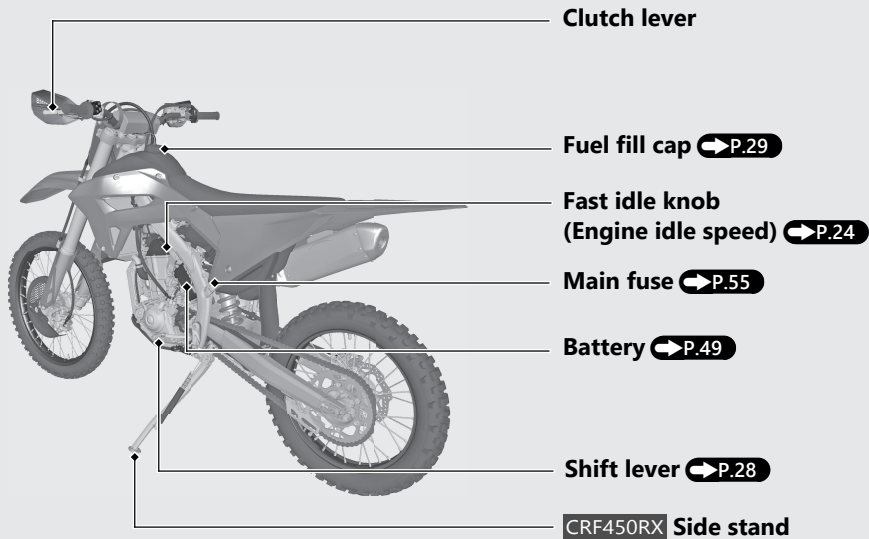

Indicators

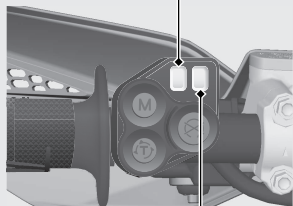

PGM-FI malfunction indicator lamp (MIL) (amber)

Comes on briefly when the engine is started.

If it comes on while engine is running: ➔ **P.53**

Engine mode indicator (blue)

Indicates the currently selected mode by blinking the mode number once when the engine is started. Indicates the currently selected mode. ➔ **P.16**

Launch control system indicator (purple)

Indicates the condition of HRC-Launch Control System.

➔ **P.21**

Torque control indicator (green)

Indicates the currently selected mode by blinking the mode number thrice when the engine is started. The Torque Control indicator (green) comes on while the system is operating.

Switches

Engine mode select button → P.16

Start button → P.24

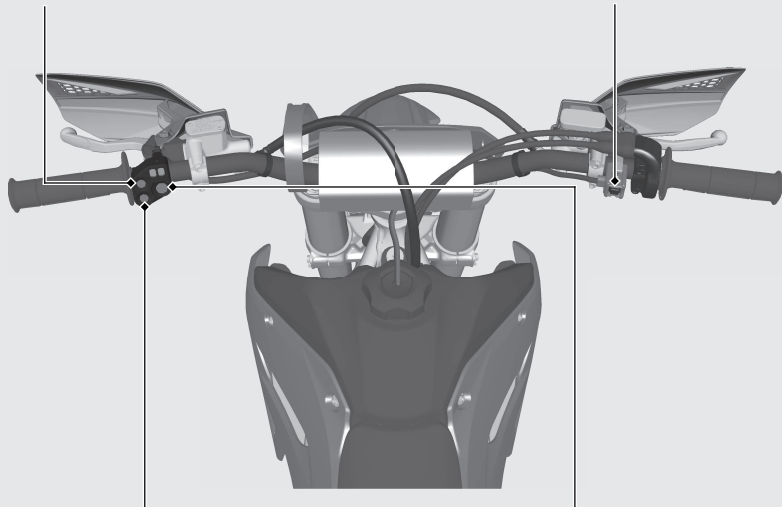

Torque control button → P.19

Engine stop button → P.27

Switches *(Continued)*

Engine Mode

You can change the engine output characteristic depending on track conditions by using the engine mode select button.

- PGM-FI mode 1: standard setting
- PGM-FI mode 2: smooth setting (reduce throttle response from the standard setting)
- PGM-FI mode 3: aggressive setting (increase throttle response from the standard setting)

Engine mode indicator (blue)

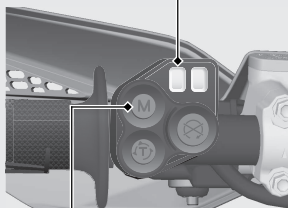

Engine mode select button

Current Mode

Start the engine and push the engine mode select button with your vehicle stopped. The engine mode indicator over the engine mode select button indicates the selected mode by blinking the mode number in blue 3 times.

Engine mode indicator (blue)

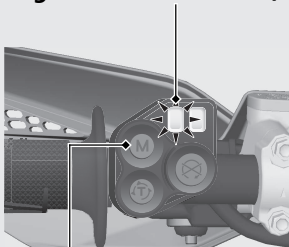

Engine mode select button

The engine mode indicator also indicates the currently selected mode by blinking the mode number once when the engine is started.

 PGM-FI mode 1:
 □ The blue indicator blinks once 3 times.

 PGM-FI mode 2:
 □ The blue indicator blinks twice 3 times.

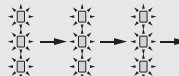
 PGM-FI mode 3:
 □ The blue indicator blinks thrice 3 times.

If the engine mode indicator stays on or does not come on when it should, have your dealer check it for problems.

Switches *(Continued)*

Mode Selection

- 1 Start the engine.
- 2 With your vehicle stopped and the throttle closed, push and hold the engine mode select button for 1 or more second.

Make sure that the fast idle knob is pushed in. **➡ P.24**

If the fast idle knob is pulled out, the engine mode will not change.

- 3 Release the engine mode select button. The engine mode indicator will indicate a selected mode by the number of times the blue indicator blinks.
- 4 Repeat steps 2 – 3 until the desired mode is indicated.

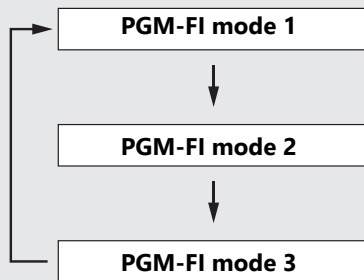

Honda Selectable Torque Control

Torque Control level can be selected or turned on/off, according to your skill and track conditions by using the Torque Control button.

The Torque Control indicator (green) comes on while the system is operating.

Torque Control indicator (green)

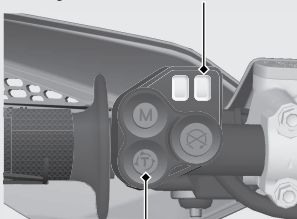

Torque Control button

Current Mode

Start the engine. The Torque Control indicator indicates the selected mode by blinking the mode number 3 times.

Torque Control mode	Rear wheel slip
1	High
2	Middle
3	Low
OFF	No operation



Torque Control mode 1:
The indicator blinks once 3 times.



Torque Control mode 2:
The indicator blinks twice 3 times.



Torque Control mode 3:
The indicator blinks thrice 3 times.



Torque Control off:
The indicator does not light up.

Honda Selectable Torque Control *(Continued)*

Mode Selection

1. Start the engine.
2. Press the Torque Control button to select a mode level. The mode changes every time you press the button.
 - ▶ The Torque Control indicator (green) will indicate a selected mode by the number of times the indicator blinks.
 - ▶ The last mode selected will be saved.
 - ▶ The factory setting is mode 2.
 - ▶ Torque Control can be turned on and off by press and hold the Torque Control button.

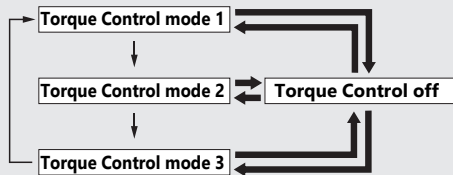

→ : Pressing the Torque Control button

➡ : Pressing and holding the Torque Control button

HRC-Launch Control System

The HRC-Launch Control System reduces slip and assists for an effective start by temporarily decreasing the rev limit when starting.

You can select the rev limit level while the system is operating according to your skill and track conditions.

To change the level

- 1 Start the engine and wait more than 2 seconds.
- 2 Close the throttle completely, press and hold the start button while pulling the clutch lever in until the launch control system indicator blinks (purple).
 - ▶ The system goes into standby, and the launch control system indicator indicates the selected level by blinking (purple).
 - ▶ From standby, the control to decrease the rev limit starts.

- ▶ The system may become disabled if you snap the throttle excessively.
- ▶ If the idle speed is low, the system may not go into standby. Set the idle speed to standard rpm.
- ▶ To disable the system, quickly press the start button. The launch control system indicator stops blinking.

Start button

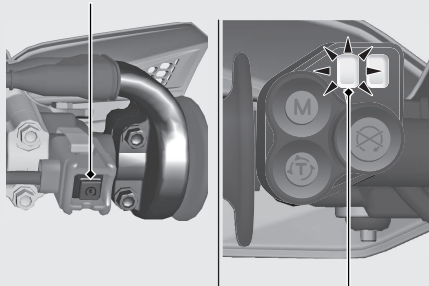

Launch control system indicator (purple)

HRC-Launch Control System *(Continued)*

- 3 Press and hold the start button. The level changes every time you press and hold.
 - ▶ The level selected last is saved.
 - ▶ The factory setting is level 2.
- 4 To continue using the system, refer to step 2 in "To operate the system" (next page). To disable the system, quickly press the start button. The launch control system indicator stops blinking and the system is disabled.

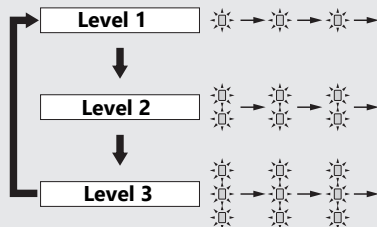

▶ Pressing and holding the start button while the launch control system is in standby

Level	Rev limit during launch control	Total number of times the launch control system indicator blinks
1	High	1
2	Middle	2
3	Low	3

| To operate the system

- ➊ Perform steps 1 and 2 in "To change the level".
- ➋ Shift into 1st or 2nd gear.
- ➌ When launching, open the throttle halfway or more. The system operates.
 - ▶ The reduced rev limit is controlled and will gradually return to normal in a few seconds. Once the rev limit returns to normal, the system is disabled.
 - ▶ The launch control system indicator comes on (purple) while the system is operating.
 - ▶ If you open the throttle halfway or more before starting, the control system stops before starting and there is no effect.
 - ▶ If you close the throttle immediately, the system may not operate.
- ▶ When the launch control system operates, these following conditions will disable launch control:
 - Vehicle is in 3rd gear
 - The throttle is completely closed
- ➍ Make sure that the launch control system indicator is off. If it is not off, the system is not disabled. Quickly press the start button to disable the system.

Starting the Engine

Start your engine using the following procedure.

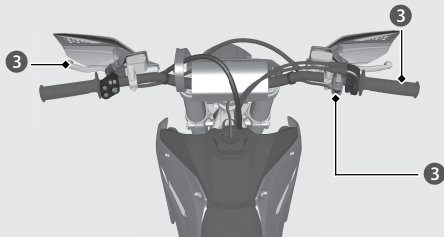
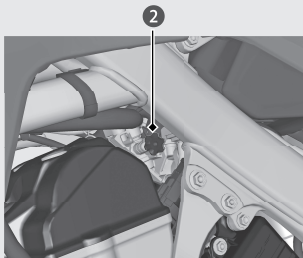

To restart a warm engine, follow the procedure for "Warm Engine Starting".

NOTICE

- If the engine does not start within 5 seconds, wait 10 seconds before trying to start the engine again to recover battery voltage.
- Extended fast idling and revving the engine can damage the engine and the exhaust system.
- Snapping the throttle or fast idling for more than about 5 minutes may cause exhaust pipe discoloration.

This vehicle does not have a start inhibitor. Pull the clutch lever all the way in when pressing the start button.

- ▶ The vehicle can move when pressing the start button if the transmission is in gear and the clutch lever is not pulled.

⚠ WARNING

Pressing the start button when the transmission is in gear and the clutch lever is not pulled in can cause the vehicle to move suddenly, which can cause serious injury or death.

Always pull the clutch lever in when pressing the start button.

Cold Engine Starting

- ➊ Shift the transmission to neutral.
- ➋ If the temperature is 50 °F (10 °C) or below, pull the fast idle knob fully out.
- ➌ With the throttle completely closed, pull the clutch lever all the way in and press the start button.
- ➍ About a minute after the engine starts, push the fast idle knob back all the way to fully off.

Starting the Engine *(Continued)*

Warm Engine Starting

- ① Shift the transmission into neutral.
- ② With the throttle completely closed, pull the clutch lever all the way in and press the start button.

Starting the engine excessively charged with fuel by throttle blipping or other reasons

- ① Shift the transmission into neutral.
- ② With the throttle fully opened, pull the clutch lever and press the start button for 5 seconds to discharge excessive fuel from the engine.
- ③ With the throttle completely closed, pull the clutch lever all the way in and press the start button.

If Engine Will Not Start ➔ P.52

When starting the engine, the PGM-FI malfunction indicator lamp (MIL) (amber) will stay on for 2 seconds, then go off. Then, the engine mode indicator (blue) indicates the current engine mode for 0.8 seconds, then goes off. If the PGM-FI malfunction indicator lamp (MIL)/engine mode indicator does not come on or go off when it should, have your dealer check it for problems.

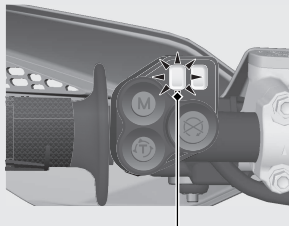

**PGM-FI malfunction indicator lamp (MIL) (amber)/
engine mode indicator (blue)**

When you stop the engine

Normal Engine Stop

- ① Shift the transmission into neutral.
- ② Push and hold the engine stop button until the engine stops completely.

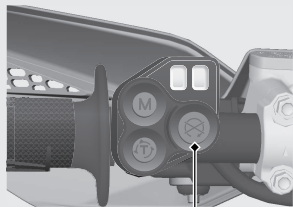

Engine stop button

Emergency Engine Stop

To stop the engine in an emergency, push and hold the engine stop button.

Shifting Gears

Your vehicle transmission has 5 forward gears in a one-down, four-up shift pattern.

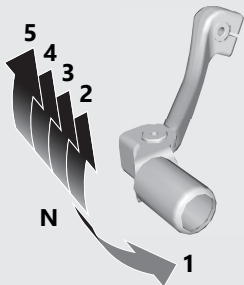

NOTICE

Improper shifting can damage the engine, transmission, and drive train. Also, coasting or towing the vehicle for long distances with the engine off can damage the transmission.

Refueling

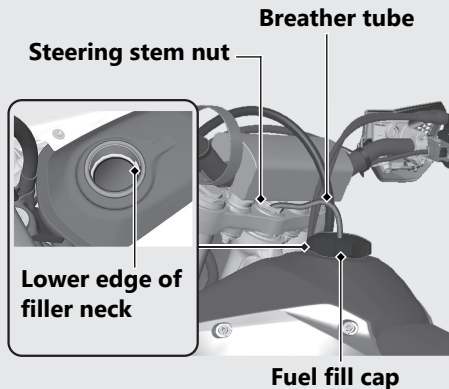

Be careful not to damage the fuel pump while filling the fuel tank. Avoid overfilling the tank. There should be no fuel in the filler neck.

Fuel type: Unleaded gasoline only

Recommended fuel octane number:

Pump Octane Number (PON) 91 or higher.

CRF450RX

Tank capacity: 2.11 US gal (8.0 L)

CRF450R/RWE

Tank capacity: 1.66 US gal (6.3 L)

Refueling and Fuel Guidelines P.9

Opening the Fuel Fill Cap

- 1 Pull the breather tube out of the steering stem nut.
- 2 Turn the fuel fill cap counterclockwise and remove it.

Refueling *(Continued)*

Closing the Fuel Fill Cap

- 1 After refueling, close the fuel fill cap securely.
- 2 Insert the breather tube into the steering stem nut.

⚠ WARNING

Gasoline is highly flammable and explosive. You can be burned or seriously injured when handling fuel.

- Stop the engine, and keep heat, sparks, and flames away.
- Only handle fuel outdoors.
- Wipe up spills immediately.

Maintenance

Please read "Importance of Maintenance", "Maintenance Fundamentals" and "Competition Handbook" carefully before attempting any maintenance. Refer to "Competition Handbook" for service data.

An optional larger tool kit may be available.

Check with your Honda dealer's parts department.

Importance of Maintenance	P. 32
Maintenance Schedule.....	P. 34
Maintenance Fundamentals	P. 39
Removing & Installing Body Components..	P. 49
Battery	P. 49

Importance of Maintenance

Importance of Maintenance

Keeping your vehicle well-maintained is absolutely essential to your safety and to protect your investment, obtain maximum performance, avoid breakdowns, and reduce air pollution. Maintenance is the owner's responsibility. Be sure to inspect your vehicle before each ride and perform the periodic checks specified in the Maintenance Schedule. ➔ P. 34

⚠️ WARNING

Improperly maintaining your vehicle or failing to correct a problem before you ride can cause a crash in which you can be seriously hurt or killed.

Always follow the inspection and maintenance recommendations and schedules in this owner's manual and competition handbook.

Maintenance Safety

Always read the maintenance instructions before you begin each task and make sure that you have the tools, parts, and skills required. We cannot warn you of every conceivable hazard that can arise in performing maintenance. Only you can decide whether or not you should perform a given task.

Follow these guidelines when performing maintenance.

- Stop the engine.
- **CRF450RX**

Place your vehicle on a firm, level surface using the side stand, an optional workstand or a maintenance stand to provide support.

CRF450R/RWE

Place your vehicle on a firm, level surface using an optional workstand or a maintenance stand to provide support.

- Allow the engine, muffler, brakes, and other high-temperature parts to cool before servicing as you can get burned.
- Run the engine only when instructed, and do so in a well-ventilated area.

Maintenance Schedule

To maintain the safety and reliability of your vehicle, regular inspection and service is required as shown in the Maintenance Schedule that follows.

The Maintenance Schedule lists items that can be performed with basic mechanical skills and hand tools. Procedures for these items are provided in Competition Handbook. The Maintenance Schedule also includes items that involve more extensive procedures and may require special training, tools, and equipment. Therefore, we recommend that you have your dealer perform these tasks unless you have advanced mechanical skills and the required tools. Procedures for items in this schedule are provided in an official Honda Service Manual available for purchase from your dealer. ➔ P. 68

CRF450RX

Service intervals in the maintenance schedule are expressed in terms of races and riding hours. To avoid overlooking required service, we urge you to develop a convenient way to record the number of races and/or hours you ride.

CRF450R/RWE

Service intervals in the maintenance schedule are expressed in terms of motos and riding hours. To avoid overlooking required service, we urge you to develop a convenient way to record the number of motos and/or hours you ride.

If you do not feel capable of performing a given task or need assistance, remember that your Honda dealer knows your vehicle best and is fully equipped to maintain and repair it. If you decide to do your own maintenance, use only Honda Genuine Parts or their equivalents for repair or replacement to ensure the best quality and reliability.

Make sure whoever performs the scheduled maintenance completes the maintenance record. Retain all service documents. If you sell your vehicle, these service documents should be transferred with the vehicle to the new owner.

Maintenance Schedule

Perform the Pre-ride Inspection (➡ P. 39) at each scheduled maintenance period.

ITEMS \ FREQUENCY	NOTE	CRF450R/RWE	Each race or about 2.5 hours	Every 3 races or about 7.5 hours	Every 6 races or about 15.0 hours	Every 9 races or about 22.5 hours	Every 12 races or about 30.0 hours
		CRF450RX	Each race or about 3.5 hours	Every 2 races or about 7.5 hours	Every 4 races or about 15.0 hours	Every 6 races or about 22.5 hours	Every 8 races or about 30.0 hours
Fuel Line	NOTE 6		I				R
Fuel Pump Filter	NOTE 6						R
Throttle Operation			I				
Air Filter	NOTE 1		C				
Crankcase Breather			I				
Spark Plug			I				
Valve Clearance/Decompressor System	NOTE 4				I		
Engine Oil	NOTE 3, 5		I		R		
Engine Oil Filter	NOTE 3				R		
Engine Idle Speed			I				

WE RECOMMEND THESE ITEMS BE SERVICED BY REFERRING TO THE OFFICIAL HONDA SERVICE MANUAL.

This maintenance schedule is based upon average riding condition. Machine subjected to severe use require more frequent servicing.

Maintenance Legend

I : Inspect (clean, adjust, lubricate, or replace, if necessary)

L : Lubricate

R : Replace

C : Clean

Maintenance Schedule

ITEMS \ FREQUENCY	NOTE	CRF450R/RWE	Each race or about 2.5 hours	Every 3 races or about 7.5 hours	Every 6 races or about 15.0 hours	Every 9 races or about 22.5 hours	Every 12 races or about 30.0 hours
		CRF450RX	Each race or about 3.5 hours	Every 2 races or about 7.5 hours	Every 4 races or about 15.0 hours	Every 6 races or about 22.5 hours	Every 8 races or about 30.0 hours
Piston and Piston Rings						Ⓡ	
Piston Pin						Ⓡ	
Radiator Coolant	NOTE 2		I				
Cooling System			I				
Drive Chain			I L		Ⓡ		
Drive Chain Slider			I				
Drive Chain Roller			I				
Drive Sprocket			I				
Driven Sprocket			I				
Brake Fluid	NOTE 2		I				
Brake Pads Wear			I				
Brake System			I				

Maintenance Schedule

ITEMS \ FREQUENCY	NOTE	CRF450R/RWE	Each race or about 2.5 hours	Every 3 races or about 7.5 hours	Every 6 races or about 15.0 hours	Every 9 races or about 22.5 hours	Every 12 races or about 30.0 hours
		CRF450RX	Each race or about 3.5 hours	Every 2 races or about 7.5 hours	Every 4 races or about 15.0 hours	Every 6 races or about 22.5 hours	Every 8 races or about 30.0 hours
Clutch Fluid	NOTE 2		I				
Clutch System	NOTE 5		I				
Control Cables			I I L				
Exhaust Pipe/Muffler			I				
Suspension			I				
Swingarm/Shock Linkage					L		
Fork Oil	NOTE 3					R	
Nuts, Bolts, Fasteners			I				
Wheels/Tires			I				
Steering Head Bearings						I	
Side Stand	NOTE 7		I				

- Notes:**
- 1 : Clean after every moto for dusty riding condition.
 - 2 : Replace every 2 years. Replacement requires mechanical skill.
 - 3 : Replace after the first break-in ride.
 - 4 : Inspect after the first break-in ride.
 - 5 : Replace the engine oil, if the clutch discs and plates are replaced.
 - 6 : Replace every year.
 - 7 : Only RX type.

Pre-ride Inspection

To ensure safety, it is your responsibility to perform a pre-ride inspection and make sure that any problem you find is corrected. A pre-ride inspection is a must, not only for safety, but because having a breakdown, or even a flat tire, can be a major inconvenience.

Refer to the Competition Handbook for procedures.

Competitive riding can be tough on a vehicle, so it's important to inspect your vehicle and correct any problems you find before each ride.

Check the following before each ride:

- Engine oil level.
- Fuel line for condition.
- Coolant for proper level.
- Cooling system and hoses for condition.
- Spark plug for proper heat range, carbon fouling and spark plug wire terminal for looseness.

- Air cleaner for condition and contamination.
- Clutch lever freeplay.
- Breather drain for cleaning.
- Steering head bearing and related parts for condition.
- Throttle operation.
- Tires for damage or improper inflation pressure.
- Spokes for looseness.
- Rim locks for looseness.
- Front and rear suspension for proper operation.
- Front and rear brakes, check operation.
- Drive chain for correct slack and adequate lubrication.
- Drive chain sliders and drive chain rollers for damage or wear.
- Exhaust pipe/Muffler for looseness.
- Every possible part for looseness (such as cylinder head bolts, engine mounting bolts/nuts, axle nuts, handlebar holder bolts, fork bridge pinch bolts, drive chain adjuster, lock nuts, drive chain roller bolt/nut, wire harness connectors).
- PGM-FI malfunction indicator lamp (MIL) operation.

Between Races/Motos & Practice Maintenance

CRF450RX

After practice or between races you have a chance to make additional checks and adjustments.

CRF450R/RWE

After practice or between motos you have a chance to make additional checks and adjustments.

- Clean accumulated dirt from under the fenders and off the wheels, suspension components, handgrips, controls, and footpegs. A stiff, nylon parts cleaning brush works well.
- Check tire air pressure.
- Check spoke tension, and make sure the rim locks are secure.

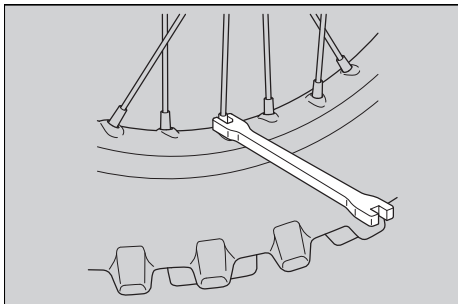

- Check to make sure the sprocket bolts and nuts are secure.
- Clean the sides of the drive chain with a stiff, nylon parts-cleaning brush. Lubricate and adjust the chain as necessary.

Do not perform maintenance while the engine is running. Injury to your fingers or hands may result.

- After adjustment, check that the chain adjuster index marks are in the same position on each side. This will ensure that the rear wheel is in proper alignment and allow maximum performance from the rear disc brake.

Maintaining proper wheel alignment will also extend brake pad lifespan.

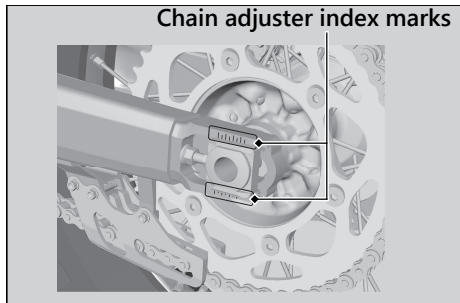

- Suspend the front wheel above the ground and use the pressure release screws to release the built-up pressure in the forks. This pressure is caused by normal fork action while riding.

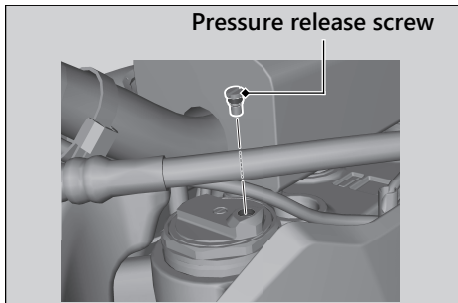

Tighten the pressure release screws to the specified torque:

Torque: 1.0 lbf·ft (1.3 N·m, 0.1 kgf·m)

After Competition Maintenance

It is important to the long term performance of your vehicle to practice a consistent maintenance program. Right after an event is a good time to begin your next maintenance cycle.

After Race Lubrication

Apply a light coating of rust-inhibiting oil to the drive sprocket and any steel portions of the chassis or engine where the paint has worn away.

This will prevent rusting of the exposed metal. Apply rust-inhibiting oil more heavily if the event was particularly wet or muddy. Take care to avoid spraying any oil near the brake pads or the brake discs.

Take care to prevent catching your fingers between the chain and sprocket.

Remove the drive chain, and clean and lubricate it. Be sure the chain is wiped clean and is dry before lubricating the chain.

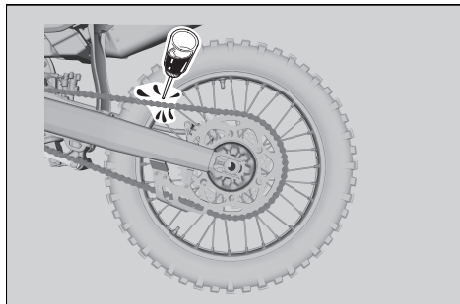

Routine Cleaning

If your vehicle is only slightly dirty, it is best to clean it by hand with the aid of a stiff bristled nylon brush and some clean rags.

Take care to prevent catching your fingers between the chain and sprocket.

A variety of reasonably priced cleaning brushes are available from variety, drug, food, and hardware stores. Some of these brushes are extremely useful in removing dirt from the many tight contours of the metal pieces of your vehicle.

Avoid using stiff, abrasive brushes on the plastic or rubber parts.

If your vehicle was exposed to sea air or salt water, rinse it as soon as possible after the event, dry it, and apply a spray lubricant to all metal parts.

If you decide to wash your vehicle or use cleaners, refer to "Caring for Your Vehicle".

➡ P. 58

Replacing Parts

Always use Honda Genuine Parts or their equivalents to ensure reliability and safety.

WARNING

Installing non-Honda parts may make your vehicle unsafe and cause a crash in which you can be seriously hurt or killed.

Always use Honda Genuine Parts or equivalents that have been designed and approved for your vehicle.

Lithium-Ion (Li-Ion) Battery

Your vehicle has a lithium-ion (li-ion) battery. Clean the battery terminals if they become dirty or corroded.

NOTICE

An improperly disposed of battery can be harmful to the environment and human health. Always confirm local regulations for proper battery disposal instruction.

What to do in an emergency

If any of the following occurs, immediately see your doctor.

- Electrolyte splashes into your eyes:
 - ▶ Wash your eyes repeatedly with cool water for at 15 minutes. Using water under pressure can damage your eyes.
- Electrolyte splashes onto your skin:
 - ▶ Remove affected clothing and wash your skin thoroughly using water.

- Electrolyte splashes into your mouth
 - ▶ Rinse mouth thoroughly with water, and do not swallow.

WARNING

The battery contains flammable organic solvent as electrolyte.

You can be burned or seriously injured if the battery is handled improperly.

- Keep the battery away from heat, sparks, and flames.
- Keep the battery out of the reach of children.
- Do not disassemble or modify the battery or battery terminals.
- Do not short-circuit the battery with metal tools or other metal objects.
- Do not subject the battery to impacts.

Cleaning the Battery Terminals

1. Remove the battery. ➔ P. 49
2. If the terminals are starting to corrode and are coated with a white substance, wash with warm water and wipe clean.
3. If the terminals are heavily corroded, clean and polish the terminals with a wire brush or sandpaper. Wear safety glasses.

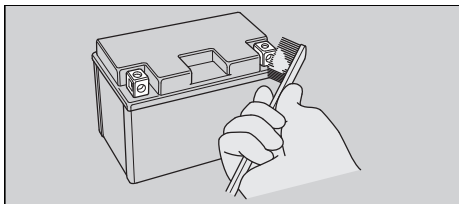

4. After cleaning, reinstall the battery. The battery has a limited life span. Consult your dealer about when you should replace the battery. Always replace the battery with another lithium-ion (li-ion) battery of the same type.

Charging

If you use electrical accessories that drain the battery or you do not ride frequently, we recommend that you charge the battery every 30 days using a charger recommended by your lithium-ion (li-ion) battery manufacturer. Contact your dealer before charging the battery.

Make sure the battery terminals are disconnected before charging the battery.

NOTICE

Only use a charger recommended by your lithium-ion (li-ion) battery manufacturer. Using a battery charger that is not recommended can cause permanent damage to your battery.

NOTICE

Improper charging can damage the battery. If you can't charge the battery or it appears unable to hold a charge, contact your dealer.

NOTICE

Do not jump-start, as this can damage your vehicle's electrical system and battery. Bump starting is not recommended.

NOTICE

Installing non-Honda electrical accessories can overload the electrical system, discharging the battery and possibly damaging the system.

Fuses

Fuses protect the electrical circuits on your vehicle. If something electrical on your vehicle stops working, check for and replace any blown fuses. ➤ P. 55

Inspecting and Replacing Fuses

Turn the engine off to remove and inspect the fuses. If a fuse is blown, replace with a fuse of the same rating. For fuse ratings, see "Specifications." ➤ P. 73

Blown fuse

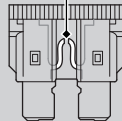

NOTICE

Replacing a fuse with one that has a higher rating greatly increases the chance of damage to the electrical system.

If a fuse fails repeatedly, you likely have an electrical fault. Have your vehicle inspected by your dealer.

Tires (Inspecting/Replacing)

Checking the Air Pressure

Visually inspect your tires and use an air pressure gauge to measure the air pressure before each ride.

Always check air pressure when your tires are cold.

If you decide to adjust the tire pressure for a particular riding condition, make changes a little at a time.

Inspecting for Damage

Inspect the tires for cuts, slits, or cracks that exposes fabric or cords, or nails or other foreign objects embedded in the side of the tire or the tread. Also inspect for any unusual bumps or bulges in the side walls of the tires.

Inspecting for Abnormal Wear

Inspect the tires for signs of abnormal wear on the contact surface.

Inspecting Rims and Valve Stems

Inspect the rims for damage and loose spokes. Also inspect the valve stems for their positions. A tilted valve stem indicates the tube is slipping inside the tire or the tire is slipping on the rim. See your dealer.

WARNING

Riding on tires that are excessively worn or improperly inflated can cause a crash in which you can be seriously hurt or killed.

Follow all instructions in this owner's manual regarding tire inflation and maintenance.

Maintenance Fundamentals

Have your tires replaced by your dealer. For recommended tires and air pressure, see "Specifications." ➤ P. 71

Follow these guidelines whenever you replace tires.

- Use the recommended tires or their equivalents of the same size, construction, speed rating, and load range.
- Remember to replace the inner tube whenever you replace a tire. The old tube will probably be stretched, and it could fail if installed in a new tire.
- If a tube is punctured or damaged, you should replace it as soon as possible. A repaired tube may not have the same reliability as a new one, and it may fail while you are riding.
Use a replacement tube equivalent to the original.

WARNING

Installing improper tires on your vehicle can adversely affect handling and stability, and can cause a crash in which you can be seriously hurt or killed.

Always use the size and type of tires recommended in this owner's manual.

Battery

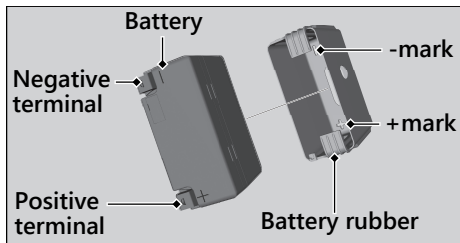
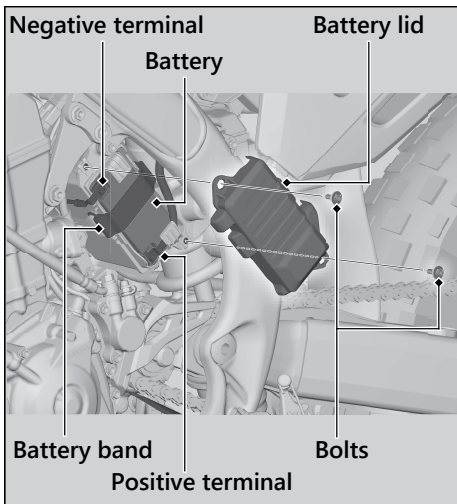

Removal

1. Remove the battery lid by removing the bolts.
2. Disconnect the negative \ominus terminal from the battery.
3. Disconnect the positive \oplus terminal from the battery.
4. Remove the battery band.
5. Remove the battery assembly, taking care not to drop the terminal nuts.
6. Separate the battery and battery rubber.

Installation

1. Assemble the battery and battery rubber.
 - Make sure the + and - marks on the bottom of the battery rubber align with the positive ⊕ and negative ⊖ of the battery terminals.
2. Install the battery assembly.
3. Install and tighten the battery terminal bolts. Always connect the positive ⊕ terminal first. Make sure that bolts and nuts are tight.
4. Tighten the positive ⊕ terminal bolt and negative ⊖ terminal bolt to the specified torque:

Torque: 1.5 lbf-ft (2 N·m, 0.2 kgf·m)

5. Install the battery band.

6. Install the battery lid and tighten the bolts to the specified torque:

Torque: 3.8 lbf-ft (5.2 N·m, 0.5 kgf·m)

For proper handling of the battery, see "Maintenance Fundamentals." ► P. 44
"Battery Goes Dead." ► P. 54

Troubleshooting

Engine Will Not Start	P. 52
Warning Indicators On or Flashing	P. 53
PGM-FI (Programmed Fuel Injection)	
Malfunction Indicator Lamp (MIL).....	P. 53
Electrical Trouble	P. 54
Battery Goes Dead.....	P. 54
Blown Fuse	P. 55

Starter Motor Operates But Engine Does Not Start

Check the following items:

- Check the correct engine starting sequence. ➔ P. 24
- Check that there is gasoline in the fuel tank.
- Check if the PGM-FI malfunction indicator lamp (MIL) is on.

Starter Motor Does Not Operate

Check the following items:

- Check the correct engine starting sequence. ➔ P. 24
- Check for a blown fuse. ➔ P. 55
- Check for a loose battery connection (➔ P. 49) or battery terminal corrosion (➔ P. 45).
- Check the condition of the battery. ➔ P. 54

If the problem continues, have your vehicle inspected by your dealer as soon as possible or refer to an official Honda Service Manual available for purchase from your dealer.

➔ P. 68

PGM-FI (Programmed Fuel Injection) Malfunction Indicator Lamp (MIL)

If the indicator comes on while riding, you may have a serious problem with the PGM-FI system.

Reduce speed and have your vehicle inspected by your dealer as soon as possible or refer to an official Honda Service Manual available for purchase from your dealer.

➡ P. 68

Battery Goes Dead

Battery charging is needed.

A battery charger recommended by your lithium-ion (li-ion) battery manufacturer is needed for battery charging.

Contact your dealer before charging the battery.

Remove the battery from the vehicle before charging.

NOTICE

Only use a charger recommended by your lithium-ion (li-ion) battery manufacturer. Using a battery charger that is not recommended can cause permanent damage to your battery.

If the battery does not recover after recharging, contact your dealer.

NOTICE

Do not jump-start, as this can damage your vehicle's electrical system and battery. Bump starting is not recommended.

Check the battery voltage using a digital multimeter with the cable connected.

Below 1V: The battery has failed; replace the battery.

Between 1V and 8V: The battery may have failed; charge the battery and then recheck. If you can't charge the battery or it appears unable to hold a charge, see your dealer.

Blown Fuse

Before handling fuses, see "Inspecting and Replacing Fuses." ► P. 46

1. Disconnect the negative \ominus terminal.
► P. 49
2. Pull back the coupler cover.
3. Disconnect the connector from the starter magnetic switch.
4. Remove the starter magnetic switch stay bolt.
5. Remove the starter magnetic switch cover.
6. Pull the main fuse and check for a blown fuse. Always replace a blown fuse with a spare of the same rating.

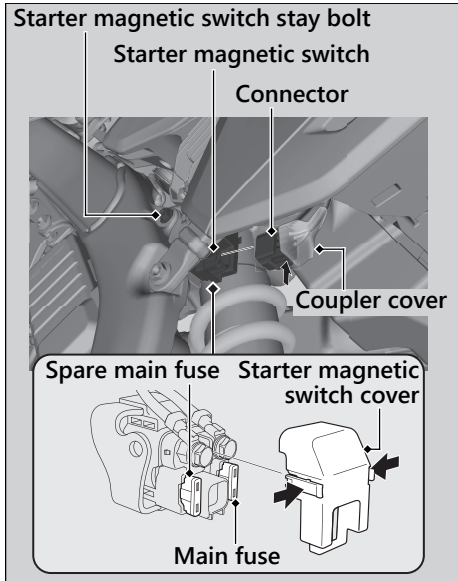

Electrical Trouble ► Blown Fuse

7. Install the starter magnetic switch cover.
8. Install and tighten the starter magnetic switch stay bolt.
9. Install the connector and coupler cover.
10. Connect the negative ⊖ terminal.

NOTICE

If a fuse fails repeatedly, you likely have an electrical problem. Have your vehicle inspected by your dealer.

Information

Caring for Your Vehicle.....	P. 58
Storing Your Vehicle.....	P. 62
Transporting Your Vehicle	P. 63
You & the Environment.....	P. 65
Vehicle Identification Number	P. 66
Oxygenated Fuels.....	P. 67
Authorized Manuals	P. 68
Honda Contacts	P. 69

Caring for Your Vehicle

Frequent cleaning and polishing is important to ensure the life of your Honda. A clean vehicle makes it easier to spot potential problems. While you're cleaning, be sure to look for damage, wear, and gasoline or oil leaks.

Washing

Allow the engine, muffler, brakes, and other high-temperature parts to cool before washing.

1. Rinse your vehicle thoroughly using a low pressure garden hose to remove loose dirt.
2. If necessary, use a sponge or a soft towel with mild cleaner to remove road grime.
 - ▶ Clean the plastic components with extra care to avoid scratching them. Avoid directing water into the air cleaner, muffler, and electrical parts.
 - ▶ Do not use steel wool to clean the frame as it could damage or discolor the frame surface. Scotch Brite Hand Pad #7447-

maroon is for removing stains on the non-coated aluminum frame only.

3. Thoroughly rinse your vehicle with plenty of clean water and dry with a soft, clean cloth.
4. After the vehicle dries, lubricate any moving parts.
 - ▶ Make sure that no lubricant spills onto the brakes or tires. Brake discs, pads, drum or shoes contaminated with oil will suffer greatly reduced braking effectiveness and can lead to a crash.
5. Lubricate the drive chain immediately after washing and drying the vehicle.
6. Apply a coat of wax to prevent corrosion.
 - ▶ Avoid products that contain harsh detergents or chemical solvents. These can damage the metal, paint, and plastic on your vehicle. Keep the wax clear of the tires and brakes.
 - ▶ If your vehicle has any matte painted parts, do not apply a coat of wax to the matte painted surface.

Washing Precautions

Follow these guidelines when washing:

- Do not use high-pressure washers:
 - ▶ High-pressure water cleaners can damage moving parts and electrical parts, rendering them inoperable.
 - ▶ Water in the air intake can be drawn into the throttle body and/or enter the air cleaner.
 - ▶ If you use a high pressure washer, avoid spraying the following areas:
 - brake master cylinders
 - clutch master cylinder
 - drive chain
 - electrical circuit
 - engine stop button
 - muffler outlet
 - steering head bearings
 - suspension pivot points
 - throttle body
 - under fuel tank
 - under seat

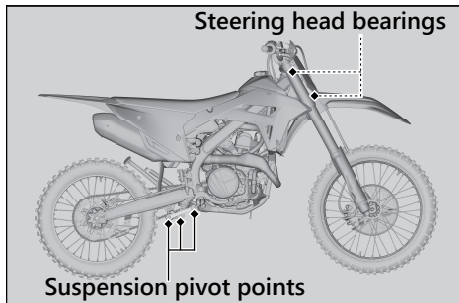

- Do not direct water at the muffler:
 - ▶ Water in the muffler can prevent starting and causes rust in the muffler.
- Dry the brakes:
 - ▶ Water adversely affects braking effectiveness. After washing, apply the brakes intermittently at low speed to help dry them.
- Do not direct water at the air cleaner:
 - ▶ Water in the air cleaner can prevent the engine from starting.

Caring for Your Vehicle

- Do not use wax or polishing compounds on matte painted surfaces:
 - ▶ Use a soft cloth or sponge, plenty of water, and a mild detergent to clean matte painted surfaces. Dry with a soft clean cloth.

Aluminum Frame Maintenance

Aluminum corrodes when it comes in contact with dust, mud and road salt.

To remove stains, use Scotch Brite Hand Pad #7447 (maroon) or an equivalent. Wet the pad and polish the surface using strokes parallel to the length of the frame.

Clean the frame using a wet sponge and a mild detergent, then rinse well with clean water. Dry the frame with a soft clean cloth, using strokes parallel to the length of the frame.

NOTICE

Do not use steel wool to clean the frame as it could damage or discolor the frame surface. Scotch Brite Hand Pad #7447-maroon is for removing stains on the non-coated aluminum frame only.

Titanium Fuel Tank Maintenance

CRF450R/RWE

The fuel tank is made of titanium material.

To remove mud or dust, use a sponge or soft cloth and a stainless steel kitchen detergent, then rinse well with clean water.

After washing, rinse with plenty of water and dry with a clean cloth.

Exhaust Pipe and Muffler

CRF450R/RX

The exhaust pipe and muffler are stainless steel but may become stained by mud or dust.

To remove mud or dust, use a wet sponge and a liquid kitchen abrasive, then rinse well with clean water. Dry with chamois or a soft towel.

If necessary, remove heat stains by using a commercially available fine texture compound. Then, rinse by the same manner as removing mud or dust.

NOTICE

Even though the exhaust is made of stainless steel, it can become stained. Remove all marks and blemishes as soon as they are noticed.

CRF450RWE

The exhaust pipe and muffler are titanium and stainless steel but may become stained by mud or dust.

To remove mud or dust, use a wet sponge and a liquid kitchen abrasive, then rinse well with clean water. Dry with chamois or a soft towel.

If necessary, remove heat stains by using a commercially available fine texture compound. Then, rinse by the same manner as removing mud or dust.

NOTICE

Even though the exhaust is made of titanium and stainless steel, it can become stained. Remove all marks and blemishes as soon as they are noticed.

Storing Your Vehicle

If you won't be riding for an extended period, follow these guidelines:

- Wash your vehicle.
- Drain the coolant.
- Lubricate the drive chain.
- Place your vehicle on an optional workstand or equivalent to raise both tires off the ground.
- Relieve the fuel pressure and drain the fuel from the fuel tank into an approved gasoline container.
- Remove the battery (➤ P. 49) to prevent discharge. Fully charge the battery and then place it in a shaded, well-ventilated area.
 - ▶ If you leave the battery in place, disconnect the negative ⊖ terminal to prevent discharge.
- Stuff a rag into the muffler outlet. Then, tie a plastic bag over the end of the muffler to prevent moisture from entering.

- Store your vehicle in an unheated area, free of dampness, away from sunlight, with a minimum of daily temperature variation.
- Cover your vehicle with a porous material. Avoid using plastic or similar non-breathing, coated materials that restrict air flow and allow heat and moisture to accumulate.

To remove your vehicle from storage, follow these guidelines:

- Uncover and clean your vehicle.
- Change the engine oil if more than 4 months have passed since the start of storage.
- Uncover the end of the muffler and remove the rag from the muffler outlet.
- Fill the fuel tank with the recommended fuel. ➤ P. 29
- Charge the battery as required. ➤ P. 44
Install the battery.
- Pour a fresh recommended coolant mixture slowly into the radiator fill hole up to the filler neck.
- Increase the fuel pressure.
- Perform all maintenance checks. ➤ P. 39

Transporting Your Vehicle

If your vehicle needs to be transported, it should be carried on a motorcycle trailer or a flatbed truck or trailer that has a loading ramp or lifting platform and motorcycle tie-down straps. Never try to tow your vehicle with a wheel or wheels on the ground.

NOTICE

Towing your vehicle with a wheel or wheels on the ground can cause serious damage to the transmission.

If you use a truck or motorcycle trailer to transport your vehicle, we recommend that you follow these guidelines:

- Use a loading ramp.
- Relieve the fuel pressure and drain the fuel from the fuel tank into an approved gasoline container.
- Secure the vehicle in an upright position, using motorcycle tie-down straps. Avoid using rope, which can loosen and allow the vehicle to fall over.

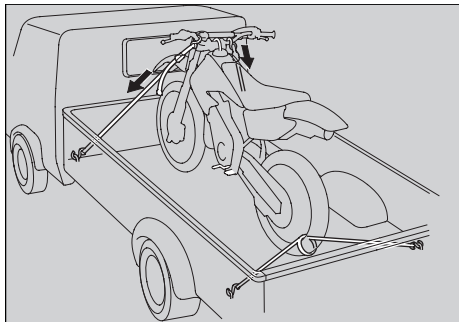

Transporting Your Vehicle

To secure your vehicle, brace the front wheel against the front of the truck bed or trailer rail. Attach the lower ends of two straps to the tie-down hooks on truck bed or trailer rail. Attach the upper ends of the straps to the handlebar (one on the right side, the other on the left), close to the fork.

Check that the tie-down straps do not contact any control cables or electrical wiring.

Tighten both straps until the front suspension is compressed about half-way. Too much pressure is unnecessary and could damage the fork seals.

Use another tie-down strap to keep the rear of the vehicle from moving.

We recommend that you do not transport your vehicle on its side. This can damage the vehicle, and leaking gasoline could be a hazard.

You & the Environment

Owning and riding a vehicle can be enjoyable, but you must do your part to protect the environment.

Choose Sensible Cleaners

Use a biodegradable detergent when you wash your vehicle. Avoid aerosol spray cleaners that contain chlorofluorocarbons (CFCs) which damage the atmosphere's protective ozone layer.

Recycle Wastes

Put oil and other toxic wastes in approved containers and take them to a recycling center. Call your local or state office of public works or environmental services to find a recycling center in your area and to get instructions on how to dispose of non-recyclable wastes. Do not place used engine oil in the trash or pour it down a drain or on the ground. Used oil, gasoline, coolant, and cleaning solvents contain poisons that can hurt refuse workers and contaminate drinking water, lakes, rivers, and oceans.

Vehicle Identification Number

The VIN and engine serial number uniquely identify your vehicle and are required in order to register your vehicle. They may also be required when ordering replacement parts. You should record these numbers and keep them in a safe place.

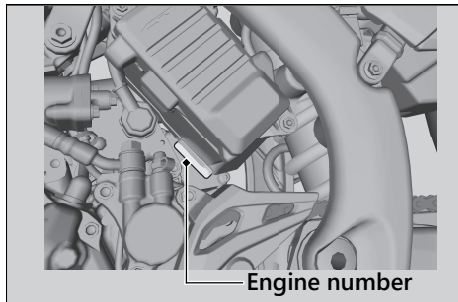
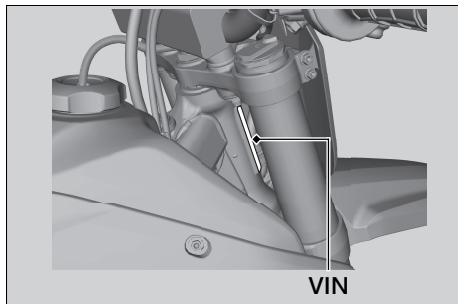

Oxygenated Fuels

Some conventional fuels blended with alcohol or an ether compound are available in some locales to help reduce emissions to meet clean air standards. These gasolines are collectively referred to as oxygenated fuels. If you plan to use oxygenated fuel, check that it is unleaded and meets the minimum octane rating and blend requirement.

The following fuel blends have been approved for use in your vehicle:

- Ethanol (ethyl alcohol) up to 10% by volume.
 - ▶ Gasoline containing ethanol may be marketed under the name Gasohol.
- Do not use gasoline containing methanol (methyl alcohol).

If you accidentally fill your fuel tank with an oxygenated fuel containing higher percentages, you may experience performance problems. To resolve the problem, have your dealer drain the fuel tank and replace with the correct fuel. Fuel system or performance problems resulting from the use of an oxygenated fuel containing higher percentages are not covered by your warranty.

NOTICE

Improper use of oxygenated fuels can damage metal, rubber, and plastic parts of your fuel system.

Oxygenated fuel can also damage paint.

If you notice any undesirable operating symptoms or performance problems, try a different brand of gasoline.

Authorized Manuals

USA The Service Manual used by your authorized dealer is available from your Honda dealer or Helm, Inc.

Canada See your dealer to order authorized manuals.

Also available, but not necessary to service your model, is the Honda Common Service Manual, which explains basic service information for various systems on Honda motorcycles, scooters, ATV, and SxS.

USA The Winter Storage Guide in conjunction with the Owner's Manual and Service Manual can help you prepare your Honda motorcycle, scooter, ATV, and SxS for winter storage.

These Honda manuals are written for the professional technician. However, if you possess the proper tools, observe the safety standards, and are mechanically capable, you should find them easy to use.

Special Honda tools are necessary for some procedures.

USA

Order online: www.helminc.com

Order Toll Free: 1-888-CYCLE93

(1-888-292-5393)

(NOTE: For Credit Card Orders Only)

Monday - Friday 8:00 AM - 6:00 PM ET

Description
2023 CRF450R/RX/RWE Service Manual
Common Service Manual (61CSM00)
USA Winter Storage Guide (S9507)
2023 CRF450R/RX/RWE Owner's Manual
2023 CRF450R/RX/RWE Competition Handbook

Honda Contacts

American Honda Motor Co., Inc.

If you wish to contact Honda directly to comment on your experiences with your vehicle or with your dealer, please send your comments using one of the following methods:



POST MAIL

Powersports Customer Relations
American Honda Motor Co., Inc.
P.O. Box 2200, Torrance, CA 90509-2200
Mailstop: 100-4W-5F



PHONE

Telephone: (866) 784-1870



ONLINE CUSTOMER SERVICE

Website: <https://powersports.honda.com/contact-us>

Canada

Honda Canada Inc.
Customer Relations Department,
180 Honda Boulevard
Markham, Ontario
L6C 0H9
Telephone: (888) 946-6329
Fax: (877) 939-0909
E-mail: honda_cr@ch.honda.com

Please include the following information in your letter:

- Name, address, and telephone number
- Product model, year, and VIN
- Date of purchase
- Dealer name and address

We will likely ask your Honda dealer to respond, or possibly acknowledge your comments directly.

Your Honda Dealer

The service department of your Honda dealer offers trained personnel to perform regular maintenance and unexpected repairs. It has the latest available service information from Honda.

The parts department offers Honda Genuine Parts, Pro Honda products, Honda Accessories (USA only), and Honda accessories and products (Canada only) that provide the same quality that went into your vehicle.

Your Honda dealer can also supply information about riding events and information about safety training available in your local area.

Specifications

■ Dimension

Overall length	CRF450RX	85.6 in (2,174 mm)
	CRF450R/RWE	85.9 in (2,182 mm)
Overall width	CRF450RX	33.0 in (839 mm)
	CRF450R/RWE	32.6 in (827 mm)
Overall height	CRF450RX	50.4 in (1,280 mm)
	CRF450R/RWE	49.9 in (1,267 mm)
Wheelbase	CRF450RX	58.1 in (1,477 mm)
	CRF450R/RWE	58.3 in (1,481 mm)
Seat height	CRF450RX	37.8 in (961 mm)
	CRF450R/RWE	38.0 in (965 mm)
Footpeg height	CRF450RX	16.8 in (427 mm)
	CRF450R/RWE	16.9 in (430 mm)
Minimum ground clearance	CRF450RX	13.1 in (334 mm)
	CRF450R/RWE	13.2 in (336 mm)
Caster angle	CRF450RX	27°18'
	CRF450R/RWE	27°7'
Trail length	CRF450RX	4.5 in (115 mm)
	CRF450R/RWE	4.5 in (114 mm)

■ Frame

Tire size	Front	CRF450RX	90/90-21 54M
		CRF450R/RWE	80/100-21 51M
	Rear	CRF450RX	120/90-18 65M
		CRF450R/RWE	120/80-19 63M
Tire type	Bias-ply, tube		
Recommended tire	Front	CRF450RX	DUNLOP AT81F
		CRF450R/RWE	DUNLOP MX33F
	Rear	CRF450RX	DUNLOP AT81
		CRF450R/RWE	DUNLOP MX33
Tire pressure (cold)	Front	15 psi (100 kPa, 1.0 kgf/cm ²)	
	Rear	15 psi (100 kPa, 1.0 kgf/cm ²)	
Fuel	Unleaded gasoline 91 PON or higher		
Fuel tank capacity	CRF450RX	2.11 US gal (8.0 L)	
	CRF450R/RWE	1.66 US gal (6.3 L)	

Specifications

■ Engine

Bore x stroke	3.7795 x 2.4464 in (96.000 x 62.138 mm)	
Displacement	27.436 cu-in (449.77 cm ³)	
Compression ratio	13.5 : 1	
Valve clearance (cold)	Intake	0.005 ± 0.001 in (0.13 ± 0.03 mm)
	Exhaust	0.011 ± 0.001 in (0.28 ± 0.03 mm)
Recommended engine oil	API Service Classification SJ or higher except oils labeled as energy conserving or resource conserving on the circular API service label, SAE 10W-30, JASO T 903 standard MA, Pro Honda GN4 4-stroke oil (USA & Canada) or Honda 4-stroke oil, or an equivalent motorcycle oil	
Engine oil capacity	After draining	1.06 US qt (1.00 L)
	After draining and oil filter change	1.10 US qt (1.04 L)
	After disassembly	1.43 US qt (1.35 L)
Idle speed	2,000 ± 100 rpm	

■ Cooling system

Recommended coolant	Pro Honda HP Coolant	
Cooling capacity	After draining	1.14 US qt (1.08 L)
	After disassembly	1.20 US qt (1.14 L)

■ Drive train

Primary reduction	2.357	
Gear ratio	1st	2.133
	2nd	1.706
	3rd	1.421
	4th	1.211
	5th	1.043
Final reduction	CRF450RX	3.846
	CRF450R/RWE	3.769
Gear shift pattern	Left foot-operated return system 1-N-2-3-4-5	

■ Electrical

Battery	HY85S lithium-ion (li-ion) 12 V-2.0 Ah (20 HR)	
Spark plug	NGK	SILMAR9A-9S
Spark plug gap	0.031 - 0.035 in (0.80 - 0.90 mm)	

■ Fuses

Main fuse	10 A
-----------	------

■ Torque specifications

Fork air pressure release screw	1.0 lbf-ft (1.3 N·m, 0.1 kgf·m)
Battery bolt	1.5 lbf-ft (2 N·m, 0.2 kgf·m)
Battery lid bolt	3.8 lbf-ft (5.2 N·m, 0.5 kgf·m)

Information Record

VIN	
Engine No.	
Color Label & Code	
Owner's Name	
Address	
City/State	
Phone	
Dealer's Name	
Address	
City/State	
Phone	
Service Manager	

California Proposition 65 Warning

⚠️ WARNING: Operating, servicing and maintaining a passenger vehicle or off-highway motor vehicle can expose you to chemicals including engine exhaust, carbon monoxide, phthalates, and lead, which are known to the State of California to cause cancer and birth defects or other reproductive harm. To minimize exposure, avoid breathing exhaust, do not idle the engine except as necessary, service your vehicle in a well-ventilated area and wear gloves or wash your hands frequently when servicing your vehicle. For more information go to www.P65Warnings.ca.gov/passenger-vehicle.



31MKE660
00X31-MKE-6600

© 2022 Honda Motor Co., Ltd.
All Rights Reserved

Printed in the U.S.A.

