



Reference Guide

FR | Guide de référence

ES | Guía de referencia

PT | Guia de Referência

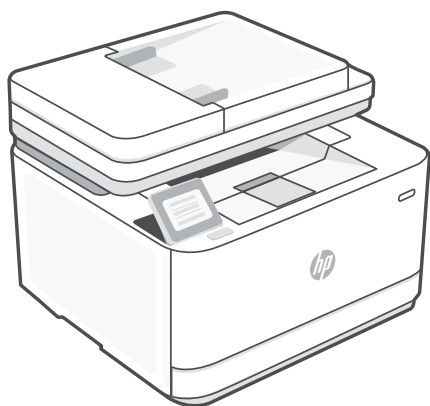

HP LaserJet Pro
MFP 3101-3108 series

Printer features

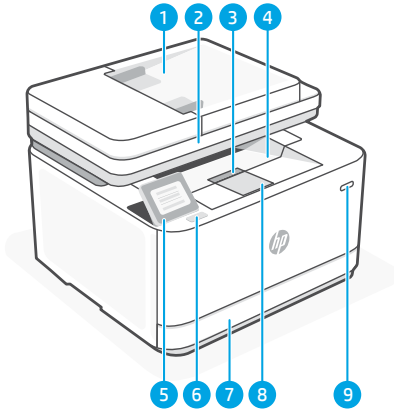









- 1 Document feeder
- 2 Scanner lid
- 3 Cartridge access door
- 4 Output tray
- 5 Control panel
- 6 Front USB port
- 7 Paper tray
- 8 Output tray extender
- 9 Power button

Control panel

Dashboard

Open the Dashboard by touching or swiping at the top of the display to access printer tasks and status.

-  Setup
-  Wireless or Ethernet
-  Wi-Fi Direct
-  Cartridge
-  Fax Status
-  HP EcoSolutions

-
-  Back
 -  Home
 -  Help

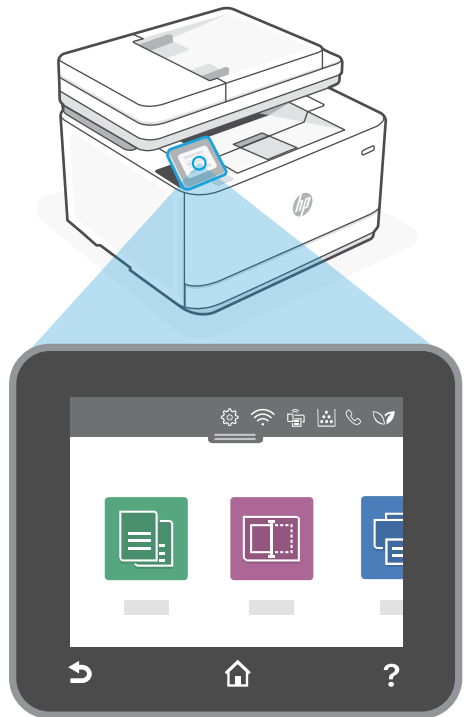

For more information on lights and errors, visit hp.com/support

Help and tips for Wi-Fi and connectivity

If the software is unable to find your printer during setup or post setup, check the following conditions to resolve the issue.

During Setup	
Potential Issue	Solution
HP software cannot find the printer during setup	If the HP software is unable to find your printer, try using the control panel to connect to a network instead. Use the control panel and follow the steps to connect the printer to the wireless network.
Computer or mobile device too far from printer	Move your computer or mobile device closer to the printer. Your device might be out of range of the printer's Wi-Fi signal.
Computer connected to a Virtual Private Network (VPN) or remote work network	Disconnect from a VPN before installing HP software. Connect to the VPN again after finishing printer setup. Note: Consider your location and the security of the Wi-Fi network before disconnecting from a VPN.
Wi-Fi turned off on computer (computer connected by Ethernet)	If your computer is connected by Ethernet, turn on the computer's Wi-Fi while setting up the printer. Disconnect the Ethernet cable temporarily to complete setup over Wi-Fi.
Bluetooth is turned off	Turn on Bluetooth services on your computer. This helps the software find your network and printer.

Post-Setup	
Potential Issue	Solution
Printer won't reconnect or maintain a connection to a network after setup	<ol style="list-style-type: none"> 1. On the Home screen, swipe down at the top of the screen to open the Dashboard and then touch  Setup. 2. Touch Network Setup > Restore Network Settings, and then follow the instructions. A message appears stating that the network defaults will be restored. Touch Yes. 3. Wait for one minute. Close and reopen HP software. 4. Right-click the printer card to remove the printer from the Home screen. Then, add the printer again and follow the on-screen prompts.



Help and Support

For printer troubleshooting and videos, visit the HP support site. Enter your model name to find the printer.



hp.com/support

Caractéristiques de l'imprimante

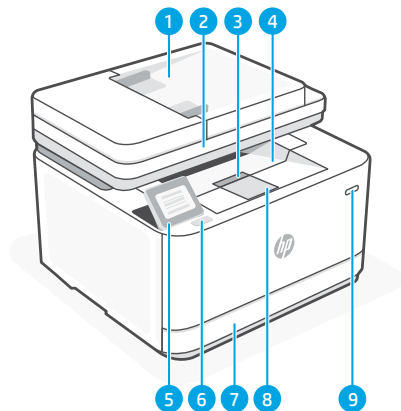







- 1 Chargeur de documents
- 2 Capot du scanner
- 3 Porte d'accès aux cartouches d'encre
- 4 Bac de sortie
- 5 Panneau de commande
- 6 Port USB avant
- 7 Bac papier
- 8 Bras d'extension du bac de sortie
- 9 Bouton Marche/Arrêt

Panel de control

Tableau de bord

Abra el panel principal tocando o deslizando la parte superior de la pantalla para acceder a las tareas y al estado de la impresora.

-  Configuración
-  Inalámbrica o Ethernet
-  Wi-Fi Direct
-  Cartucho
-  Estado del fax
-  HP EcoSolutions (HP y el medio ambiente)

-
-  Atrás
 -  Inicio
 -  Ayuda

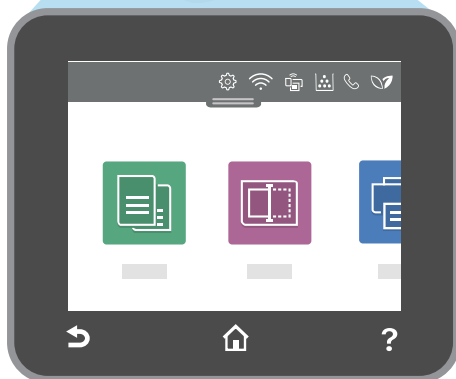
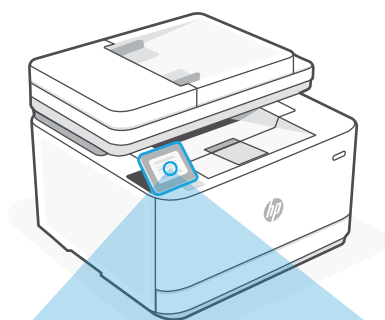

Para obtener más información sobre los indicadores luminosos y los errores, visite hp.com/support

Aide et conseils pour le Wi-Fi et la connectivité

Si le logiciel ne parvient pas à trouver votre imprimante pendant ou après la configuration, vérifiez les conditions suivantes pour résoudre le problème.

Pendant la configuration

Problème potentiel	Solution
Le logiciel HP ne parvient pas à trouver l'imprimante pendant la configuration	Si le logiciel HP ne parvient pas à trouver votre imprimante, essayez d'utiliser le panneau de commande pour vous connecter à un réseau. Utilisez le panneau de commande et suivez les étapes pour connecter l'imprimante au réseau sans fil.
Ordinateur ou périphérique mobile trop éloigné de l'imprimante	Rapprochez votre ordinateur ou périphérique mobile de l'imprimante. Votre périphérique est peut-être hors de portée du signal Wi-Fi de l'imprimante.
Ordinateur connecté à un Réseau privé virtuel (VPN) ou un réseau professionnel distant	Déconnectez l'ordinateur du VPN avant l'installation du logiciel HP. Connectez-vous à nouveau au VPN après avoir terminé la configuration de l'imprimante. Remarque : Tenez compte de votre emplacement et de la sécurité du réseau Wi-Fi avant de le déconnecter d'un VPN.
Wi-Fi désactivé sur l'ordinateur (ordinateur connecté par Ethernet)	Si votre ordinateur est connecté par Ethernet, activez le Wi-Fi de l'ordinateur pendant la configuration de l'imprimante. Débranchez temporairement le câble Ethernet pour terminer la configuration sur le Wi-Fi.
La fonction Bluetooth est éteinte	Activez les services Bluetooth sur votre ordinateur. Cela aidera le logiciel à retrouver votre réseau et votre imprimante.

Après la configuration

Problème potentiel	Solution
L'imprimante ne se reconnecte pas ou ne maintient pas la connexion au réseau après la configuration	<ol style="list-style-type: none">1. Sur l'écran d'accueil, balayez vers le bas en haut de l'écran pour ouvrir le tableau de bord, puis appuyez sur  Configuration.2. Appuyez sur Configuration Réseau > Restaurer les paramètres réseau, puis suivez les instructions. Un message s'affiche pour indiquer que les paramètres réseau par défaut seront restaurés. Appuyez sur Oui.3. Patientez environ une minute. Fermez et ouvrez à nouveau le logiciel HP.4. Faites un clic droit sur la carte de l'imprimante pour supprimer l'imprimante de l'écran d'accueil. Ensuite, ajoutez à nouveau l'imprimante et suivez les instructions à l'écran.



Aide et support

Pour un dépannage d'imprimante et des vidéos, consultez le site d'assistance HP. Saisissez le nom de modèle pour retrouver l'imprimante.



hp.com/support

Características de la impresora

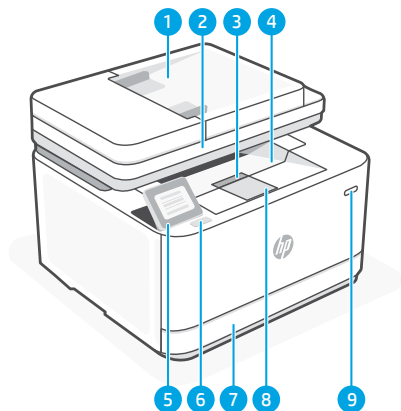







- 1 Alimentador de documentos
- 2 Tapa del escáner
- 3 Puerta de acceso al cartucho
- 4 Bandeja de salida
- 5 Panel de control
- 6 Puerto USB frontal
- 7 Bandeja del papel
- 8 Extensor de la bandeja de salida
- 9 Botón de encendido

Panel de control

Panel

Abra el panel principal tocando o deslizando la parte superior de la pantalla para acceder a las tareas y al estado de la impresora.

-  Configuración
-  Inalámbrica o Ethernet
-  Wi-Fi Direct
-  Cartucho
-  Estado del fax
-  HP EcoSolutions (HP y el medio ambiente)

-
-  Atrás
 -  Inicio
 -  Ayuda

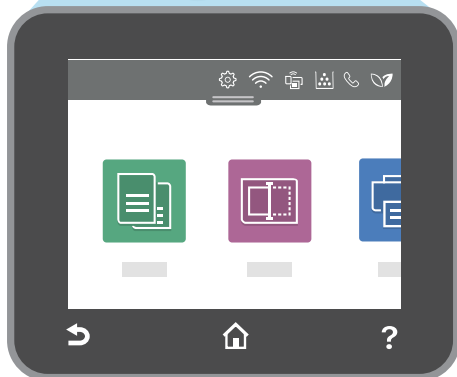
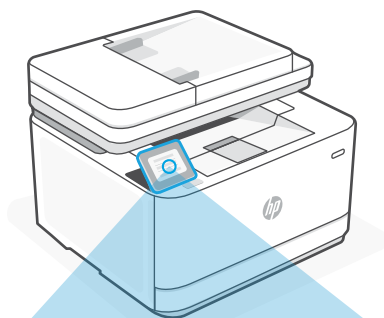

Para obtener más información sobre los indicadores luminosos y los errores, visite hp.com/support

Ayuda y consejos para Wi-Fi y conectividad

Si el software no logra detectar su impresora durante o después de la configuración, compruebe las siguientes condiciones para resolver el problema.

Durante la configuración	
Possible problema	Solución
El software de HP no puede detectar la impresora durante la configuración	Si el software de HP no puede detectar su impresora, intente utilizar el panel de control para conectarse a una red. Utilice el panel de control y siga los pasos para conectar la impresora a la red inalámbrica.
El ordenador o el dispositivo móvil están demasiado lejos de la impresora	Sítue el ordenador o el dispositivo móvil más cerca de la impresora. Es posible que el dispositivo esté fuera del alcance de la señal Wi-Fi de la impresora.
Ordenador conectado a una red privada virtual (VPN) o a una red de trabajo remota	Desconéctese de la VPN antes de instalar el software de HP. Conéctese de nuevo a la VPN tras finalizar la configuración de la impresora. Nota: Tenga en cuenta su ubicación y la seguridad de la red Wi-Fi antes de desconectarse de una VPN.
Wi-Fi desactivada en el ordenador (ordenador conectado por Ethernet)	Si su ordenador está conectado a través de Ethernet, encienda la Wi-Fi del ordenador mientras configura la impresora. Desconecte el cable Ethernet temporalmente para completar la configuración a través de la Wi-Fi.
El Bluetooth está desactivado	Active los servicios de Bluetooth en su ordenador. Esto ayuda al software a detectar su red y su impresora.

Después de la configuración	
Possible problema	Solución
La impresora no se vuelve a conectar o mantiene la conexión con una red después de la configuración	<ol style="list-style-type: none"> 1. En la pantalla de inicio, deslice hacia abajo la parte superior de la pantalla para abrir el Panel de control y luego toque  Configuración. 2. Toque Configuración de red > Restablecer configuración de la red y luego siga las instrucciones. Aparecerá un mensaje indicando que los valores predeterminados de la red se han restaurado. Toque Sí. 3. Espere durante un minuto. Cierre y vuelva a abrir el software de HP. 4. Haga clic con el botón derecho en la tarjeta de la impresora para quitar la impresora de la pantalla de inicio. Luego, vuelva a agregar la impresora y siga las instrucciones en pantalla.



Ayuda y soporte técnico

Para la solución de problemas de la impresora y vídeos, visite el sitio de soporte de HP. Introduzca el nombre del modelo para encontrar su impresora.



hp.com/support

Recursos da impressora

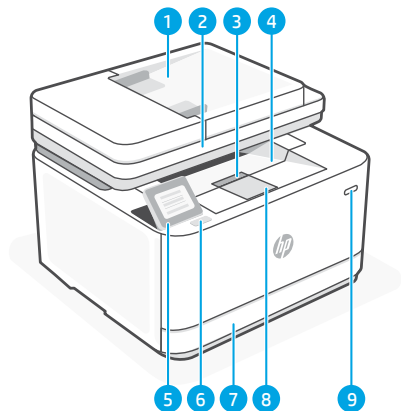

- 1 Alimentador de documentos
- 2 Tampa do scanner
- 3 Porta de acesso aos cartuchos
- 4 Bandeja de saída
- 5 Painel de controle
- 6 Porta USB frontal
- 7 Bandeja de papel
- 8 Extensão da bandeja de saída
- 9 Botão Liga/Desliga

Painel de controle

Painel

Abra o Painel, tocando ou deslizando o dedo no topo da tela, para acessar as tarefas e o status da impressora.

-  Configuração
-  Sem fio ou Ethernet
-  Wi-Fi Direct
-  Cartucho
-  Status do fax
-  HP EcoSolutions

-
-  Voltar
 -  Início
 -  Ajuda

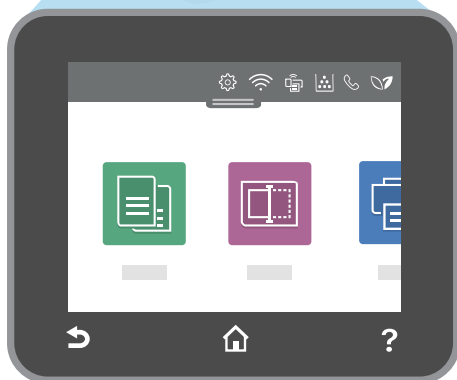
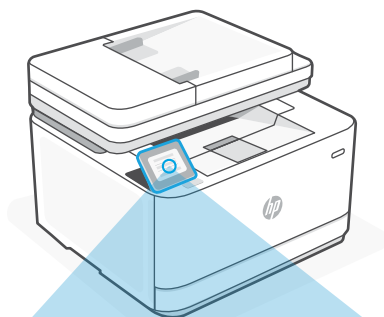

Para mais informações sobre luzes e erros, acesse hp.com/support

Ajuda e dicas para Wi-Fi e conectividade

Se o software não conseguir encontrar sua impressora durante ou após a configuração, verifique as seguintes condições para resolver o problema.

Durante a configuração	
Possível problema	Solução
O software HP não consegue encontrar a impressora durante a configuração	Se o software HP não puder encontrar sua impressora, tente usar o painel de controle para se conectar a uma rede. Use o painel de controle e siga as instruções para conectar a impressora à rede sem fio.
Computador ou dispositivo móvel muito longe da impressora	Aproxime o computador ou o dispositivo móvel da impressora. Seu dispositivo pode estar fora do alcance do sinal de Wi-Fi da impressora.
Computador conectado a uma rede privada virtual (VPN) ou rede de trabalho remota	Desconecte-se da VPN antes de instalar o software HP. Conecte-se à VPN novamente depois de terminar a configuração da impressora. Observação: Verifique sua localização e a segurança da rede Wi-Fi antes de se desconectar de uma VPN.
Wi-Fi desativado no computador (que está conectado por Ethernet)	Se o computador estiver conectado pela Ethernet, ative o Wi-Fi dele enquanto configura a impressora. Desconecte o cabo Ethernet temporariamente para concluir a configuração via Wi-Fi.
O Bluetooth está desligado	Ligue os serviços Bluetooth no seu computador. Isso ajuda o software a encontrar sua rede e a impressora.

Depois da configuração	
Possível problema	Solução
A impressora não se reconecta ou mantém uma conexão a uma rede depois da configuração	<ol style="list-style-type: none">1. Na tela Inicial, deslize para baixo, a partir do topo da tela, para abrir o Painel, e toque  Configuração.2. Toque Configuração de rede > Restaurar configurações de rede e siga as instruções. Uma mensagem é exibida informando que os padrões da rede foram restaurados. Toque Sim.3. Aguarde um minuto. Feche e reabra o software HP.4. Clique com o botão direito no cartão da impressora, para removê-la da tela Inicial. Depois, readicione a impressora e siga os prompts na tela.



Ajuda e suporte

Para ver a solução de problemas e vídeos da impressora, acesse o site de suporte da HP. Informe o nome do modelo para localizar a impressora.



hp.com/support



© Copyright 2021 HP Development Company, L.P.

Microsoft and Windows are either registered trademarks or trademarks of Microsoft Corporation in the United States and/or other countries. Mac, OS X, macOS, and AirPrint are trademarks of Apple Inc., registered in the U.S. and other countries. Android is a trademark of Google LLC. iOS is a trademark or registered trademark of Cisco in the U.S. and other countries and is used under license.

Microsoft et Windows sont soit des marques soit des marques déposées de Microsoft Corporation aux États-Unis et/ou dans d'autres pays. Mac, OS X, macOS et AirPrint sont des marques déposées d'Apple, Inc. aux États-Unis et dans d'autres pays. Android est une marque de Google LLC. iOS est une marque déposée de Cisco aux États-Unis et dans d'autres pays et est utilisée dans le cadre d'une licence.

Printed in Vietnam
Impreso en Vietnam

Imprimé au Vietnam
Impresso no Vietnã

EN FR ES PT



3G627-90022

