

User Guide

Kasa Smart Wi-Fi Light Switch, Single Pole
KS200

Contents

About This Guide	1
Introduction	2
Appearance	3
Wire Your Switch.....	5
Set Up Your Switch	8
Add Your Switch to Home	9
Third Party Services.....	11
Authentication.....	15

About This Guide

This guide provides a brief introduction to Kasa Smart Wi-Fi Light Switch and regulatory information.

Features available in Kasa Smart may vary by model. All images, steps, and descriptions in this guide are only examples and may not reflect your actual Kasa Smart experience.

Conventions

In this guide, the following convention is used:

Convention	Description
Teal	Key information appears in teal, including management page text such as menus, items, buttons and so on.
<u>Underline</u>	Hyperlinks are in teal and underlined. You can click to redirect to a website.

More Info

- Specifications can be found on the product page at <https://www.tp-link.com>.
- Our Technical Support contact information can be found at the Help center of the Kasa Smart app and the Contact Technical Support page at <https://www.tp-link.com/support>.

Introduction

TP-Link Smart Wi-Fi Light Switch is a standard, single-pole, wall light switch that can be controlled via your iOS or Android devices. Control your home lighting or ceiling fans on your phone from anywhere, anytime with the Kasa Smart app. Turn fixtures on and off, set schedules, even group them with other Kasa Smart devices. The Kasa Smart app provides easy step-by-step installation instructions and convenient remote control from anywhere.



- **Apple HomeKit Supported** - Integrate your devices easily into your Apple ecosystem and control them using the Apple Home app and Siri on your iPhone, iPad, Apple Watch, HomePod, or Mac.
- **Control From Anywhere** - Control anything connected to your smart light switch, like lights, ceiling fans or other fixtures, from anywhere using the Kasa Smart app.
- **Voice Control** - With any Alexa, Siri or Google Assistant you can control any fixture connected to your Kasa Smart light switch with simple voice commands. Scan for HomeKit setup
- **Grouping** - Use Grouping to combine your light switch with other Kasa Smart devices for seamless control with one single tap on your smartphone.
- **Away Mode** - Set your smart light switch to turn connected fixtures on and off at random intervals to give the appearance you're home even while you're away.
- **Easy Install** - No need to understand complex wiring, just follow the step-by-step wiring process in the Kasa Smart app for a guided installation of your smart light switch.
- **No Hub Required** - The Kasa Smart Wi-Fi Light Switch connects to your home's secure Wi-Fi network. No need for a hub or extra equipment.

Appearance

The Smart Switch is compatible with incandescent, LED, Halogen, and compact fluorescent light bulbs. The switch also includes a white backlight LED indicator to easily locate the switch at night. See the explanation below:

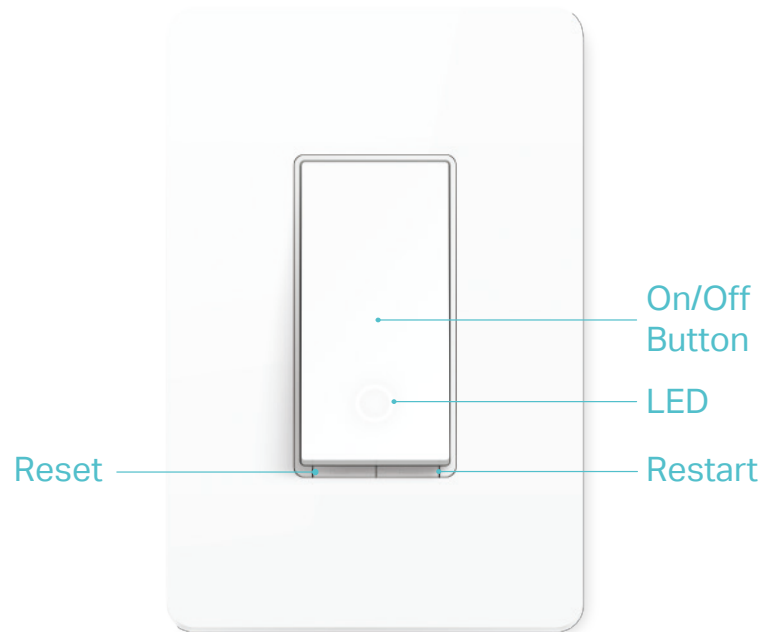

Button Explanations

Reset	Press and hold for about 5s to reset Wi-Fi while keeping other settings.
	Press and hold for about 10s to restore your switch to factory default settings.
Restart	Press to restart your switch.

LED Status

Solid amber	Starting up.
Blinking amber & green	Ready for setup; Resetting Wi-Fi.
Blinking green	Connecting to Wi-Fi.
Stay green for 30s	Connected to Wi-Fi.
Blinking amber	Device resetting.
White	Light fixture is off.

Detach the Wallplate

Carefully insert a flat-bladed screw driver the opening at the bottom of the wallplate and pull forward to remove the wallplate.

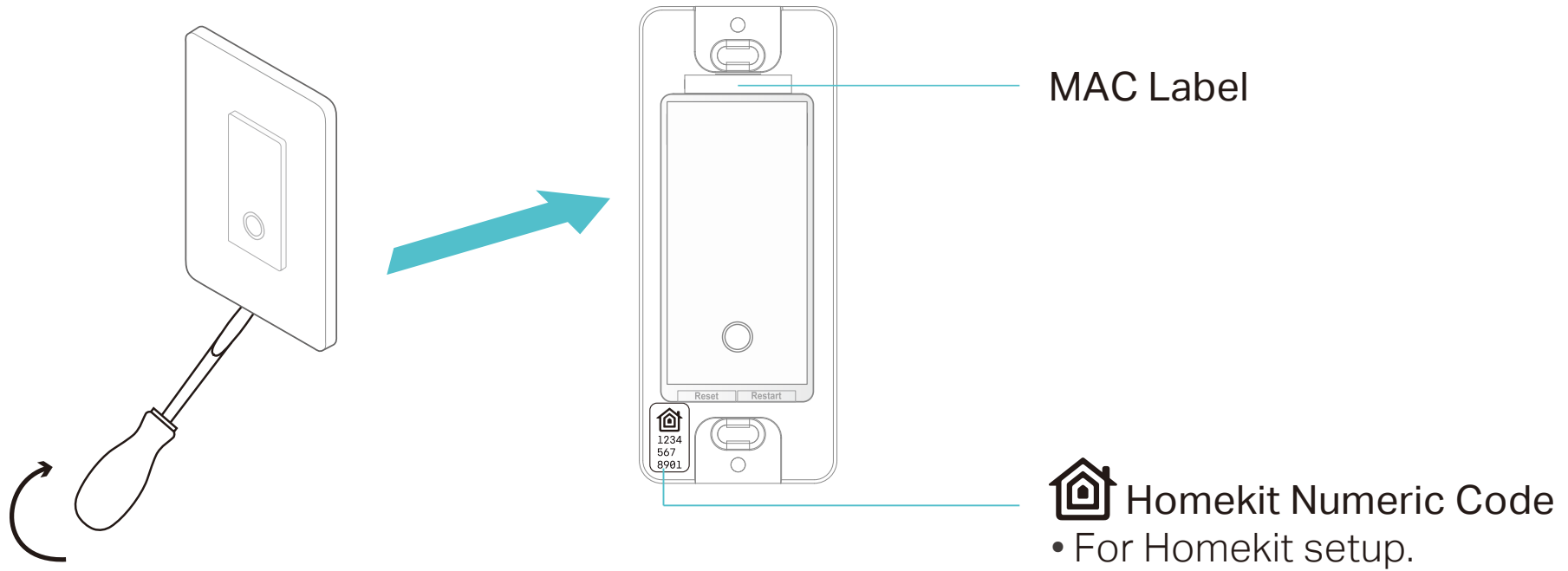

*Images may differ from your actual product.

Note: You can find another Homekit setup code label in the package and stick it anywhere you like as needed for Homekit setup.

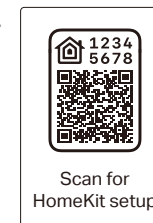

Wire Your Switch

Follow the steps below to wire your Smart Wi-Fi Light Switch. If you are not familiar with basic electrical wiring, please consult an electrician.

Before You Start

1. Prepare Basic knowledge of Wiring

- **Ground:** Usually green or copper.
- **Neutral:** Usually white, not connected to the dumb switch.
- **Line:** Usually black and coming from the circuit breaker.
- **Load:** Usually black. One end is connected to the light.

Note: If you are unsure, consult a qualified electrician.

2. Prepare Your Tools

Prepare a philips and slotted screwdriver, pliers, wire strippers and a voltage detector.

3. Check Wi-Fi Strength

Make sure your switch is in a area with strong Wi-Fi signal.

Wire Your Switch

Step 1. Turn Off Power and Remove the Wallplate

Turn off the circuit breaker. Then remove the old wallplate of the wall switch and label the wires.

CAUTION
Risk of Electric Shocks - High Voltage - Disconnect power supply before servicing.

MISE EN GARDE
Risque d'électrocution - Haute tension. Débrancher l'alimentation électrique avant d'utiliser.

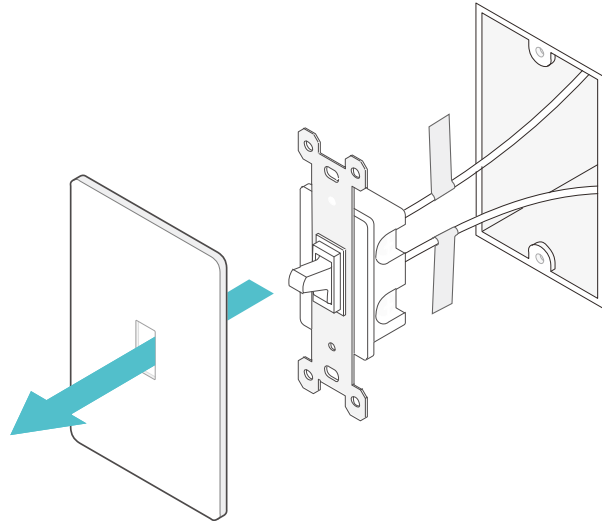

Step 2. Expose Your Switch Wiring

Remove the screws securing your old switch to the wall box. Gently pull the switch out and disconnect wires from the old switch.

Step 3. Label and Connect the Wires

Use the labels and wire nuts to Connect the wires to the smart switch as shown below.

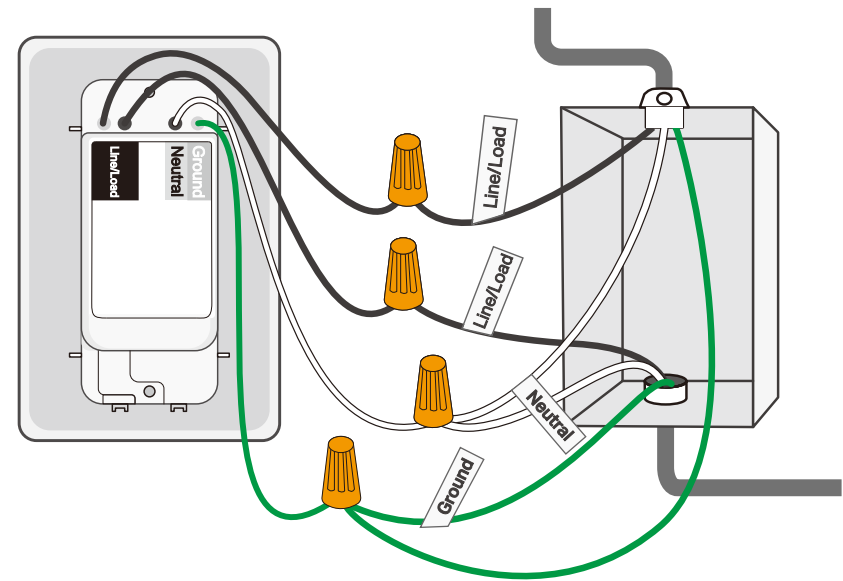

Note: No need to distinguish between Line and Load wires.

Step 4. Install Your Smart Switch

Gently fold all of the wires back into the wall box. Line up the switch with the mounting holes. Secure it with screws.

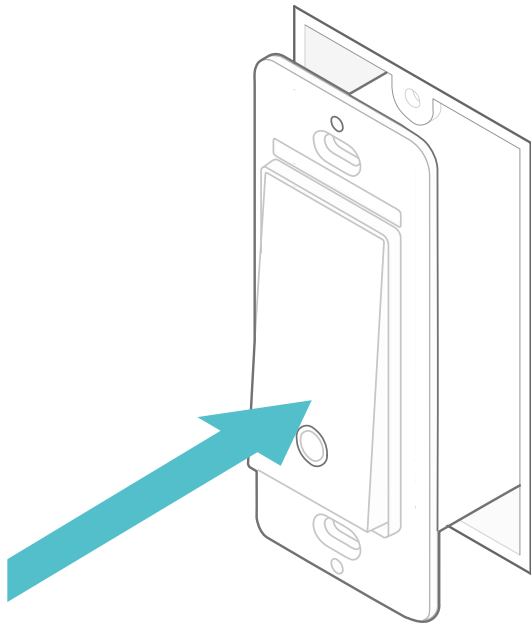

Step 5. Attach the Wallplate and Turn on Power

Attach the wallplate and turn on the circuit breaker. Then the wiring is finished.

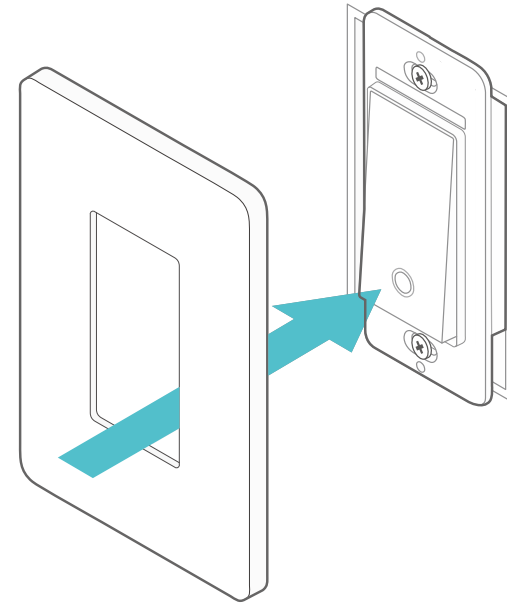

Set Up Your Switch

Follow the steps below to set up your Smart Light Switch via [Kasa Smart](#) app.

1. Download and install Kasa app

Go to Google Play or the App Store or scan the QR code below to download the [Kasa Smart](#) app on your Android or iOS smartphone or tablet.



OR



2. Log in or sign up with TP-Link ID

Open the app. Use your TP-Link ID to log in.

If you don't have a TP-Link ID, tap [Create Account](#) and the Kasa Smart app will guide you through the rest.

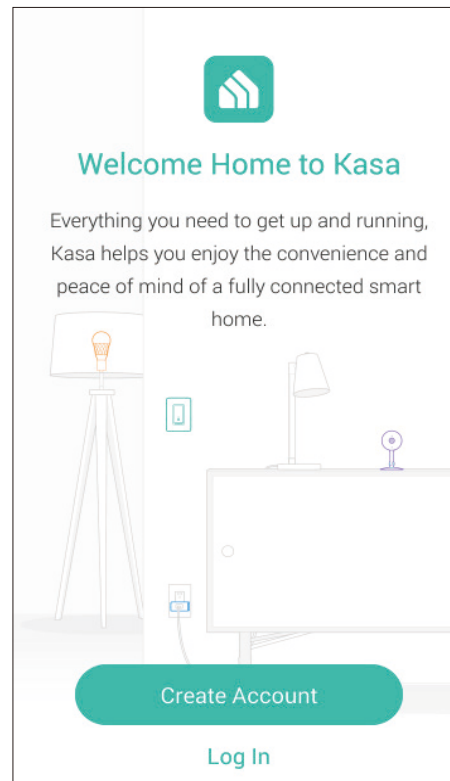

3. Add Device

Tap the + button in the Kasa Smart app, select [Smart Switches](#) > [Homekit Smart Switch](#), and then follow step-by-step app instructions to complete the installation and setup.

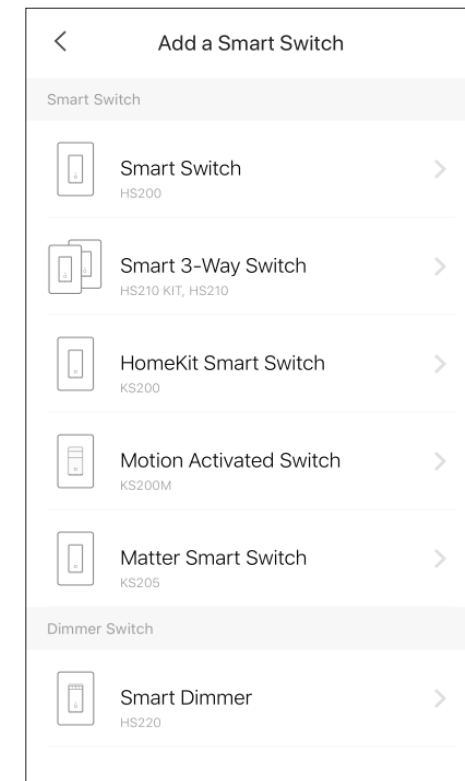

Add Your Switch to Home

This is a HomeKit-enabled device. You can also add it to the Home app for easy control from your iPhone or iPad. Follow the steps below to add your smart switch via the [Home](#) app.

Before you start:

1. Your iPhone or iPad should be connected to a stable 2.4 GHz Wi-Fi network.
2. To control this HomeKit-enabled accessory, the latest version of iOS or iPadOS is recommended.
3. HomeKit will be disabled after 10 minutes since the smart switch is powered on. You can power off your device and power it back on, then try again.

Add to Home

1. Open the Home app. Or if you have added the smart switch to Kasa Smart, you can also tap [Add to Home](#) in the [Device Settings](#) page.

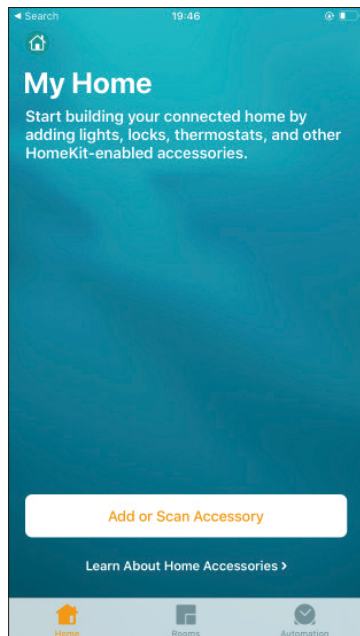

2. Scan the HomeKit QR code on the provided label. It will be added to Home automatically.

Failed to add to Home?

1. Press and hold the Power button for at least 10 seconds to factory reset the smart switch and restart your phone. Then try again.

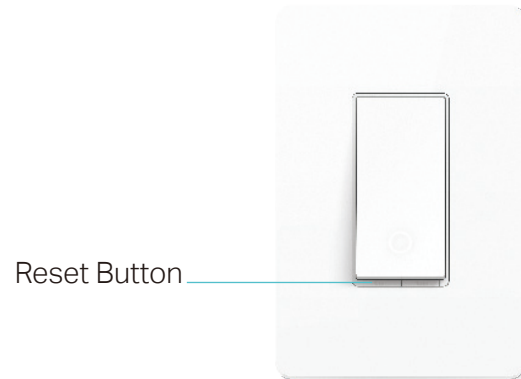

2. Ensure both your iPhone/iPad and the smart switch closer to the router to get a stronger Wi-Fi signal.
3. Turn off the Wi-Fi on your iPhone/iPad for a few seconds, then turn it back on to clear the cache of the Home app.
4. Make sure your iPhone/iPad is connected to the 2.4 GHz Wi-Fi network. Set different names for 2.4 GHz and 5 GHz networks, or temporarily turn off the router's 5 GHz Wi-Fi until your smart device is successfully added.
5. Change the router's 2.4 GHz Wi-Fi channel to a fixed one, such as 1, 6, and 11. Then reboot your router.
6. If you still cannot add the smart switch to Home, set it up with Kasa Smart manually. Then follow the app instructions to add your smart switch.
7. If the problem persists, refer to the FAQ for detailed instructions: <https://www.tp-link.com/support/faq/3390/>



Third Party Services

Use the Kasa Smart app to pair your Smart devices with Amazon Alexa or Google Home Assistant, and enjoy a full hands-free experience. Kasa helps manage the rest of your smart home too, working with Samsung SmartThings to trigger changes when you arrive home or leave for the day.

Launch the **Kasa Smart** app. Go to the Me page and tap **Third Party Services**. You can choose **Amazon Alexa** / **Google Assistant** / **IFTTT** / **Samsung SmartThings** for detailed instructions.

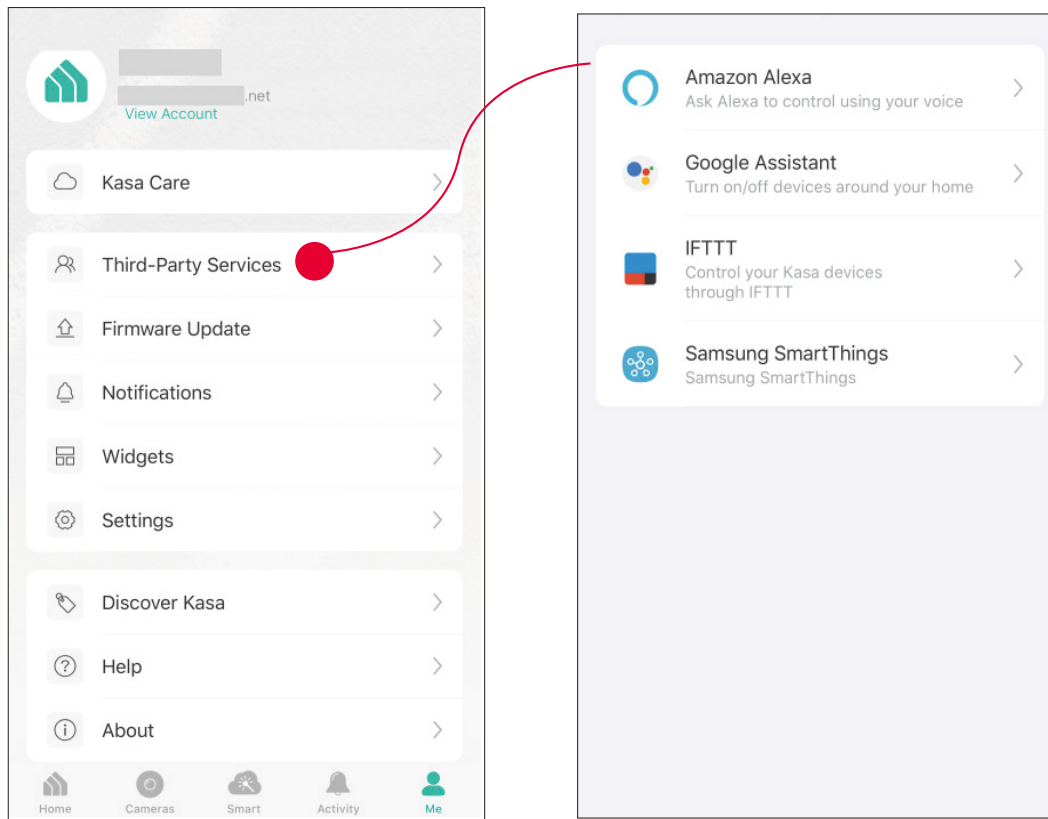

1. Set up Amazon Alexa

1. Tap [Amazon Alexa](#).

2. Tap [Connect](#).

3. Sign in with your amazon account.

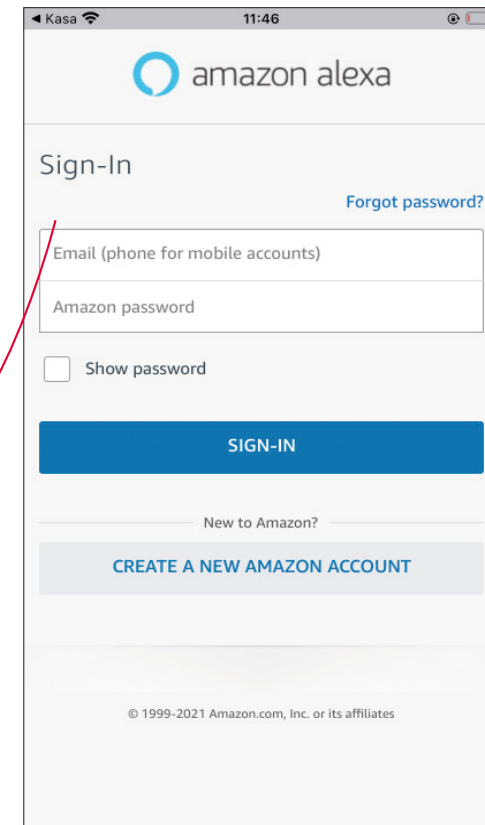
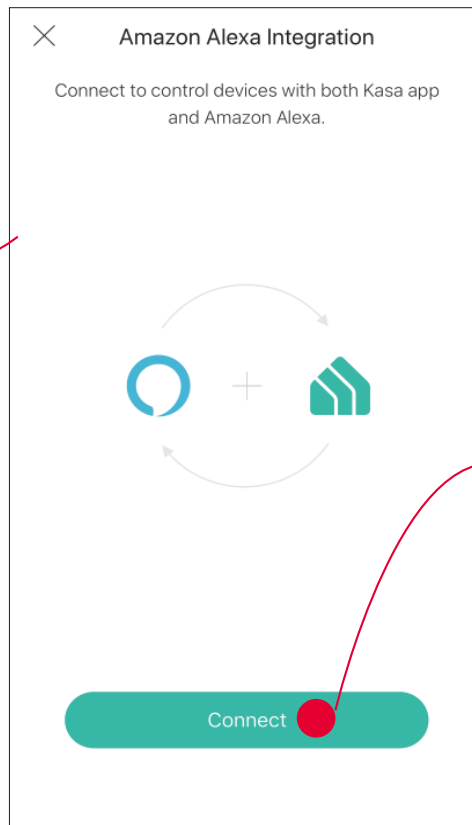
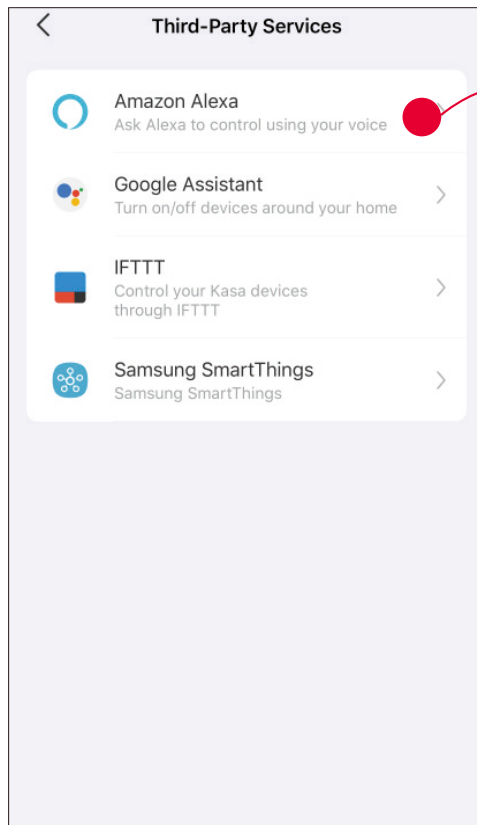

3. After sign-in, tap [LINK](#).

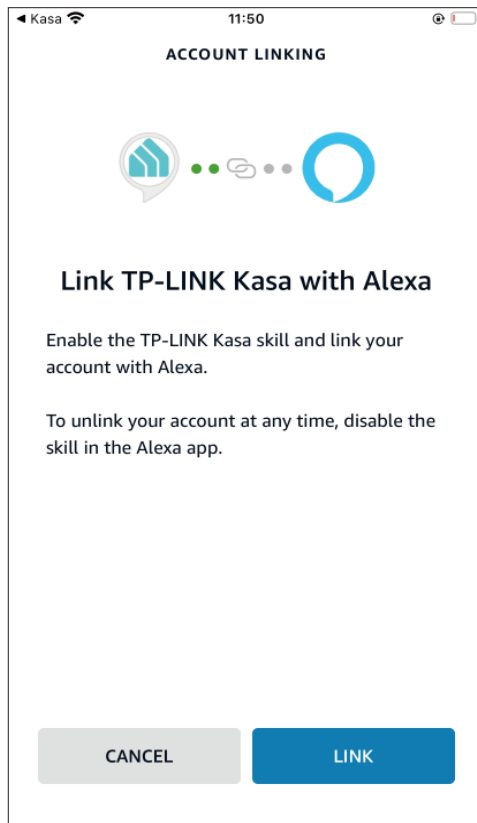

4. Your TP-Link ID has been successfully linked with your amazon account. You can use Alexa voice commands to control your smart device.

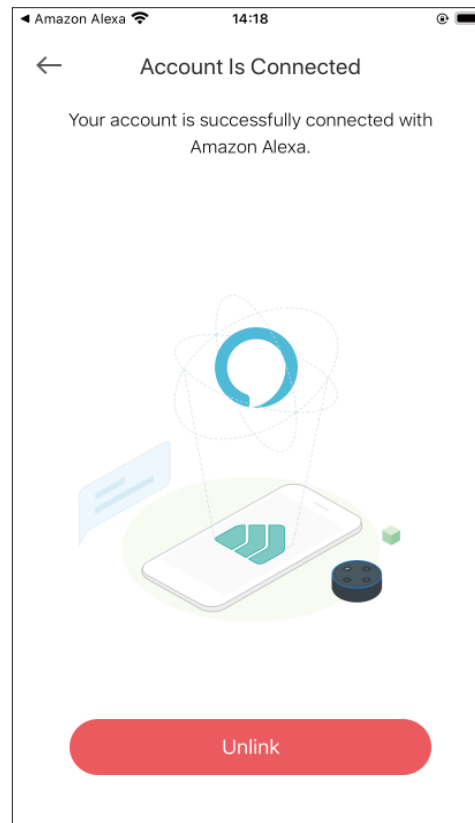

2. Set up Google Assistant

1. Tap [Google Assistant](#).

2. Follow instructions to connect your device to your Google Home.

Or find the FAQ at <https://www.tp-link.com/en/support/faq/1534/>.

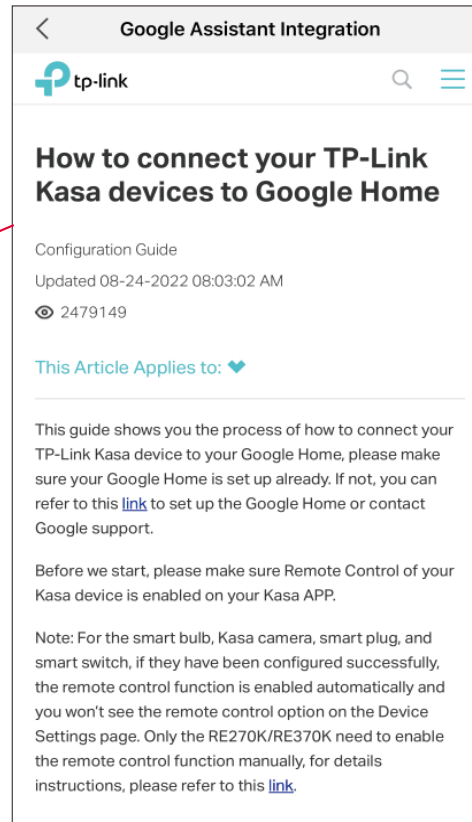
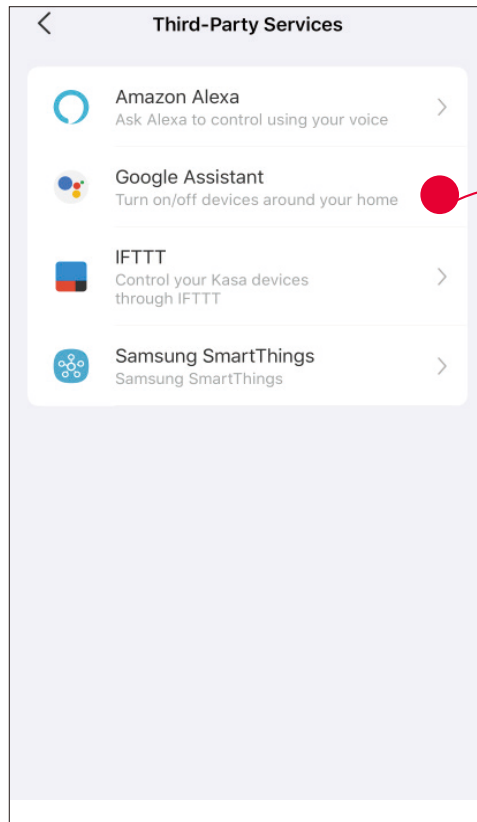

Authentication

FCC compliance information statement



Product Name: Kasa Smart Wi-Fi Light Switch,Single Pole
Model Number: KS200

Responsible party:

TP-Link USA Corporation

Address: 10 Mauchly, Irvine, CA 92618

Website: <http://www.tp-link.com/us/>

Tel: +1 626 333 0234

Fax: +1 909 527 6804

E-mail: sales.usa@tp-link.com

This equipment has been tested and found to comply with the limits for a Class B digital device, pursuant to part 15 of the FCC Rules. These limits are designed to provide reasonable protection against harmful interference in a residential installation. This equipment generates, uses and can radiate radio frequency energy and, if not installed and used in accordance with the instructions, may cause harmful interference to radio communications. However, there is no guarantee that interference will not occur in a particular installation. If this equipment does cause harmful interference to radio or television reception, which can be determined by turning the equipment off and on, the user is encouraged to try to correct the interference by one or more of the following measures:

- Reorient or relocate the receiving antenna.
- Increase the separation between the equipment and receiver.
- Connect the equipment into an outlet on a circuit different from that to which the receiver is connected.
- Consult the dealer or an experienced radio/ TV technician for help.

This device complies with part 15 of the FCC Rules. Operation is subject to the following two conditions:

1. This device may not cause harmful interference.
2. This device must accept any interference received, including interference that may cause undesired operation.

Any changes or modifications not expressly approved by the party responsible for compliance could void the user's authority to operate the equipment.

Note: The manufacturer is not responsible for any radio or TV interference caused by unauthorized modifications to this equipment. Such modifications could void the user's authority to operate the equipment.

FCC RF Radiation Exposure Statement

This equipment complies with FCC RF radiation exposure limits set forth for an uncontrolled environment. This device and its antenna must not be co-located or operating in conjunction with any other antenna or transmitter.

"To comply with FCC RF exposure compliance requirements, this grant is applicable to only Mobile Configurations. The antennas used for this transmitter must be installed to provide a separation distance of at least 20 cm from all persons and must not be co-located or operating in conjunction with any other antenna or transmitter."

We, **TP-Link USA Corporation**, has determined that the equipment shown as above has been shown to comply with the applicable technical standards, FCC part 15. There is no unauthorized change is made in the equipment and the equipment is properly maintained and operated.

Issue Date: 2021.03.25

Canadian Compliance Statement

This device contains licence-exempt transmitter(s)/receiver(s) that comply with Innovation, Science and Economic Development Canada's licence-exempt RSS(s). Operation is subject to the following two conditions:

(1) This device may not cause interference.

(2) This device must accept any interference, including interference that may cause undesired operation of the device.

L'émetteur/récepteur exempt de licence contenu dans le présent appareil est conforme aux CNR d'Innovation, Sciences et Développement économique Canada applicables aux appareils radio exempts de licence. L'exploitation est autorisée aux deux conditions suivantes :

1) L'appareil ne doit pas produire de brouillage;

2) L'appareil doit accepter tout brouillage radioélectrique subi, même si le brouillage est susceptible d'en compromettre le fonctionnement.

Radiation Exposure Statement:

This equipment complies with IC radiation exposure limits set forth for an uncontrolled environment. This equipment should be installed and operated with minimum distance 20cm between the radiator & your body.

Déclaration d'exposition aux radiations:

Cet équipement est conforme aux limites d'exposition aux rayonnements IC établies pour un environnement non contrôlé. Cet équipement doit être installé et utilisé avec un minimum de 20 cm de distance entre la source de rayonnement et votre corps

Industry Canada Statement

CAN ICES-3 (B)/NMB-3(B)

NCC Notice

注意!

取得審驗證明之低功率射頻器材，非經核准，公司、商號或使用者均不得擅自變更頻率、加大功率或變更原設計之特性及功能。

低功率射頻器材之使用不得影響飛航安全及干擾合法通信；經發現有干擾現象時，應立即停用，並改善至無干擾時方得繼續使用。

前述合法通信，指依電信管理法規定作業之無線電通信。

低功率射頻器材須忍受合法通信或工業、科學及醫療用電波輻射性電機設備之干擾。

BSMI Notice

安全諮詢及注意事項

- 請使用原裝電源供應器或只能按照本產品注明的電源類型使用本產品。
- 清潔本產品之前請先拔掉電源線。請勿使用液體、噴霧清潔劑或濕布進行清潔。
- 注意防潮，請勿將水或其他液體潑灑到本產品上。
- 插槽與開口供通風使用，以確保本產品的操作可靠並防止過熱，請勿堵塞或覆蓋開口。
- 請勿將本產品置放於靠近熱源的地方。除非有正常的通風，否則不可放在密閉位置中。
- 不要私自拆開機殼或自行維修，如產品有故障請與原廠或代理商聯繫。

限用物質含有情況標示聲明書

設備名稱： Equipment name Kasa Smart Wi-Fi Light Switch, Single Pole		型號（型式）：KS200 Type designation (Type)				
單元 Unit	限用物質及其化學符號 Restricted substances and its chemical symbols					
	鉛 Lead (Pb)	汞 Mercury (Hg)	鎘 Cadmium (Cd)	六價鉻 Hexavalent chromium (Cr+6)	多溴聯苯 Polybrominated biphenyls (PBB)	多溴二苯醚 Polybrominated diphenyl ethers (PBDE)
PCB	○	○	○	○	○	○
外殼	○	○	○	○	○	○
電源供應板	—	○	○	○	○	○
其他及其配件	—	○	○	○	○	○

備考 1. “超出 0.1 wt %” 及 “超出 0.01 wt %” 係指限用物質之百分比含量超出百分比含量基準值

Note 1: “Exceeding 0.1 wt %” and “exceeding 0.01 wt %” indicate that the percentage content of the restricted substance exceeds the reference percentage value of presence condition.

備考 2. “○” 係指該項限用物質之百分比含量未超出百分比含量基準值。

Note 2: “○” indicates that the percentage content of the restricted substance does not exceed the percentage of reference value of presence.

備考 3. “—” 係指該項限用物質為排除項目。

Note 3: The “—” indicates that the restricted substance corresponds to the exemption.

Safety Information

Before installing, servicing or removing the switch, read and follow all safety precautions including the following:

- Follow all national and local safety regulations and practices. If you are uncertain or uncomfortable when performing the installation, consult a qualified electrician.
- CAUTION – Risk of Electric Shock – More than one disconnect switch may be required to de-energize the equipment and luminaire before servicing. A circuit breaker which disconnects the Line and Neutral conductor simultaneously is suitable.
- CAUTION – High Voltage – Disconnect power supply before servicing. Ensure power is off at the circuit breaker before removing or installing any switch. Use a non-contact voltage tester to ensure the power is off.
- Do not install the Smart Switch with wet hands or when standing on wet or damp surfaces.
- Keep the device away from water, fire, humidity or hot environments.
- Do not attempt to disassemble, repair, or modify the device. If you need service, please contact us.
- Do not use the device where wireless devices are not allowed.
- Rating: 100-120 V~ 50/60 Hz
- Supported Load: 15 A General Use, 600 W Incandescent, 120 W Max Ceiling Fan, 1/6 HP Motor.
- Operation temperature: 0~40°C (32~104°F)
- Install only in a suitable UL Listed outlet box (suitable dimensions: H > 2.95 in./75 mm, W > 1.81 in./46 mm, D > 2 in./51 mm).



CAUTION

Electrical switch integrated in this product is only intended for functional purposes. De-energized the product at the circuit breaker before servicing.

Explanation of the symbols on the product label

Symbol	Explanation
	Alternating current
	Indoor use only
	<p>RECYCLING</p> <p>This product bears the selective sorting symbol for Waste electrical and electronic equipment (WEEE). This means that this product must be handled pursuant to European directive 2012/19/EU in order to be recycled or dismantled to minimize its impact on the environment.</p> <p>User has the choice to give his product to a competent recycling organization or to the retailer when he buys a new electrical or electronic equipment.</p>