

Operator's Manual

CRAFTSMAN®

25cc/1.5 cu.in. 2-Cycle

200 MPH/430 CFM

GASOLINE POWERED BLOWER/VAC

Model No.

358.794732



- Safety
- Assembly
- Operation
- Maintenance
- Parts List
- Español, p. 21

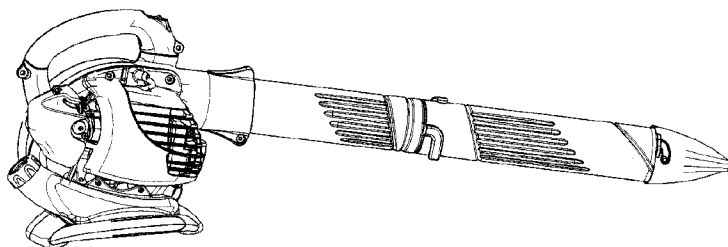

WARNING:

Read and follow all Safety Rules and Operating Instructions before first use of this product.



For answers to your questions about this product:
Call 7 am-7 pm, Mon.-Sat., or 10 am-7 pm, Sun.

1-800-235-5878

(Hours listed are Central Time)

Sears, Roebuck and Co., Hoffman Estates, IL 60179 U.S.A.

545218613 Rev. 6 5/31/09 BRW

TABLE OF CONTENTS

Warranty Statement	2	Storage	14
Identification of Safety Symbols	2	Troubleshooting Table	15
Safety Rules	4	Emissions Statement	16
Assembly	6	Parts List	18
Operation	9	Spanish	21
Maintenance	12	Parts and Ordering	Back Cover

WARRANTY STATEMENT

CRAFTSMAN FULL WARRANTY

If this Craftsman product fails due to a defect in material or workmanship within two years from the date of purchase, return it to any Sears store, Parts & Repair Service Center, or other Craftsman outlet in the United States for free repair (or replacement if repair proves impossible).

This warranty applies for only 90 days if this product is ever used for commercial or rental purposes.

This warranty covers ONLY defects in material and workmanship. Sears will NOT pay for:

- Expendable items that can wear out from normal use within the warranty period, such as the vacuum bag, filter or spark plug.
- Repairs necessary because of accident or failure to operate or maintain the product according to all supplied instructions.
- Preventive maintenance, or repairs necessary due to improper fuel mixture, contaminated or stale fuel.

This warranty gives you specific legal rights, and you may also have other rights which vary from state to state.

Sears, Roebuck and Co., Hoffman Estates, IL 60179

IDENTIFICATION OF SAFETY SYMBOLS



WARNING: This unit can be dangerous! Careless or improper use can cause serious injury.



Read your operator's manual carefully until you completely understand and can follow all warnings and safety rules before operating the unit. Failure to do so can result in serious injury. Save operator's manual.



The blower can throw objects violently. You can be blinded or injured. Always wear hearing protection and safety glasses marked Z87. Always wear heavy, long pants, long sleeves, boots and gloves.

IDENTIFICATION OF SAFETY SYMBOLS

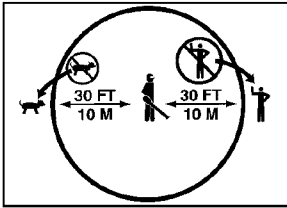

Hazard zone for thrown objects. Keep children, bystanders, and animals away from work area a minimum of 30 feet (10 meters) when starting or operating unit. Do not point blower nozzle in the direction of people or pets.



Secure hair above shoulder length. Do not wear jewelry, loose clothing, or clothing with loosing hanging straps, ties, tassels, etc. They can be caught in moving parts.

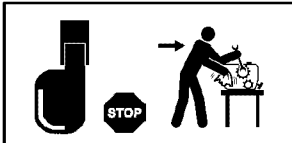

Always stop unit and disconnect spark plug before cleaning or servicing.



⚠ WARNING: Stop the engine before opening the vacuum inlet door. The engine must be stopped and the impeller blades no longer turning to avoid serious injury from the rotating blades. Gently tilt the handle of the screwdriver toward the back of the unit to release the latch while pulling up on the vacuum inlet cover with your other hand.



When using the vacuum attachment, the unit is designed to pick up dry material such as leaves, grass, small twigs, and bits of paper. Do not vacuum stones, gravel, metal, broken glass, etc., to avoid severe damage to the impeller.



⚠ WARNING: Fire hazard. Never mix, pour, or store gasoline or use the unit near a flame or sparks (including smoking, open flames, or work that can cause sparks).



⚠ WARNING: The muffler is very hot during and after use. Do not touch the muffler, muffler guard, or surrounding surfaces, or allow combustible material such as dry grass or fuel to do so.

SAFETY RULES

⚠ WARNING: Failure to follow all Safety Rules and Precautions can result in serious injury.

KNOW YOUR UNIT

- Read your operator's manual carefully until you completely understand and can follow all warnings and safety rules before operating the unit.
- Restrict unit to users who understand and will follow all warnings and safety rules in this manual.

⚠ WARNING: Inspect area before starting unit. Remove all debris and hard objects such as rocks, glass, wire, etc. that can ricochet, be thrown, or otherwise cause injury or damage during operation.

Use your unit as a blower for:

- Sweeping debris or grass clippings from driveways, sidewalks, patios, etc.
- Blowing grass clippings, straw, or leaves into piles, around joints, or between bricks.

Use your unit as a vacuum for:

- Picking up dry material such as leaves, grass, small twigs, and bits of paper.
- For best results during vacuum use, operate your unit at high speed.
- Move slowly back and forth over the material as you vacuum. Avoid forcing the unit into a pile of debris as this can clog the unit.
- Keep the vacuum tube about an inch above the ground for best results.

PLAN AHEAD

- Always wear eye protection when operating, servicing, or performing maintenance on unit. Wearing eye protection will help to prevent rocks or debris from being blown or ricocheting into eyes and face which can result in blindness and/or serious injury. Eye protection should be marked Z87.
- Always wear foot protection. Do not go barefoot or wear sandals.
- Always wear respirator or face mask when working with unit in dusty environments.
- Secure hair above shoulder length. Secure or remove jewelry, loose clothing, or clothing with loosely hanging straps, ties, tassels, etc. They can be caught in moving parts.

- Do not operate unit when you are tired, ill, upset, or if you are under the influence of alcohol, drugs, or medication.
- Keep children, bystanders, and animals away from work area a minimum of 30 feet (10 meters) when starting or operating unit. Do not point blower nozzle in the direction of people or pets.

HANDLE FUEL WITH CAUTION, IT IS HIGHLY FLAMMABLE

- Eliminate all sources of sparks or flame (including smoking, open flames, or work that can cause sparks) in the areas where fuel is mixed, poured, or stored.
- Mix and pour fuel in an outdoor area; store fuel in a cool, dry, well ventilated place; use an approved, marked container for all fuel purposes.
- Do not smoke while handling fuel or while operating the unit.
- Make sure the unit is properly assembled and in good operating condition.
- Do not fill fuel tank while engine is running.
- Avoid spilling fuel or oil. Wipe up fuel spills before starting engine.
- Move at least 10 feet (3 meters) away from fuel and fueling site before starting engine.
- Always store gasoline in a container approved for flammable liquids.

OPERATE YOUR UNIT SAFELY

- ⚠ WARNING:** Stop the engine before opening the vacuum inlet door. The engine must be stopped and the impeller blades no longer turning to avoid serious injury from the rotating blades.
- Inspect unit before each use for worn, loose, missing, or damaged parts. Do not use until unit is in proper working order.
 - Keep outside surfaces free from oil and fuel.
 - Never start or run engine inside a closed room, building or other unventilated area. Breathing exhaust fumes can kill.
 - To avoid static electricity shock, do not wear rubber gloves or any other insulated gloves while operating unit.

- Do not set unit on any surface except a clean, hard area while engine is running. Debris such as gravel, sand, dust, grass, etc. could be picked up by the air intake and thrown out through discharge opening, damaging unit, property, or causing serious injury to bystanders or operator.
- Avoid dangerous environments. Do not use in unventilated areas or where explosive vapors or carbon monoxide build up could be present.
- Do not overreach or use from unstable surfaces such as ladders, trees, steep slopes, rooftops, etc. Keep firm footing and balance at all times.
- Never place objects inside the blower tubes; always direct the blowing debris away from people, animals, glass, and solid objects such as trees, automobiles, walls, etc. The force of air can cause rocks, dirt, or sticks to be thrown or to ricochet which can hurt people or animals, break glass, or cause other damage.
- Never run unit without the proper equipment attached. When using your unit as a blower, always install blower tubes. When using the optional vacuum kit, always install vacuum tubes and vacuum bag assembly. Make sure vacuum bag assembly is completely zipped.
- Check air intake opening, blower tubes, and vacuum tubes frequently, always with engine stopped and spark plug disconnected. Keep vents and discharge tubes free of debris which can accumulate and restrict proper air flow.
- Never place any object in air intake opening as this could restrict proper air flow and cause damage to the unit.
- Never use for spreading chemicals, fertilizers, or other substances which may contain toxic materials.
- To avoid spreading fire, do not use near leaf or brush fires, fireplaces, barbecue pits, ashtrays, etc.
- Use only for jobs explained in this manual.

MAINTAIN YOUR UNIT PROPERLY

-  **WARNING:** Disconnect spark plug before performing maintenance except for carburetor adjustments.
- Have all maintenance other than the recommended procedures described

in the operator's manual performed by a Sears Service Center.

- Use only recommended Craftsman replacement parts; use of any other parts may void your warranty and cause damage to your unit.
- Empty fuel tank before storing the unit. Use up fuel left in carburetor by starting engine and letting it run until it stops.
- Do not use any accessory or attachment other than those recommended by manufacturer for use with your unit.
- Do not store the unit or fuel in a closed area where fuel vapors can reach sparks or an open flame from hot water heaters, electric motors or switches, furnaces, etc.
- Store in a dry area out of reach of children.

SAFETY NOTICE: Exposure to vibrations through prolonged use of gasoline powered hand tools could cause blood vessel or nerve damage in the fingers, hands, and joints of people prone to circulation disorders or abnormal swelling. Prolonged use in cold weather has been linked to blood vessel damage in otherwise healthy people. If symptoms occur such as numbness, pain, loss of strength, change in skin color or texture, or loss of feeling in the fingers, hands, or joints, discontinue the use of this tool and seek medical attention. An antivibration system does not guarantee the avoidance of these problems. Users who operate power tools on a continual and regular basis must monitor closely their physical condition and the condition of this tool.

SPECIAL NOTICE: This unit is equipped with a temperature limiting muffler and spark arresting screen which meets the requirements of California Codes 4442 and 4443. All U.S. forest land and the states of California, Idaho, Maine, Minnesota, New Jersey, Oregon, and Washington require by law that many internal combustion engines be equipped with a spark arresting screen. If you operate in a locale where such regulations exist, you are legally responsible for maintaining the operating condition of these parts. Failure to do so is a violation of the law. Refer to the MAINTENANCE section for information on maintenance of the muffler and spark arresting screen.

ASSEMBLY

CARTON CONTENTS

Check carton contents against the following list.

Model 358.794732

- Blower
- Upper blower tube
- Lower blower tube
- High velocity nozzle
- Elbow tube
- Vacuum bag
- Upper vacuum tube
- Lower vacuum tube
- 2-Cycle engine oil

NOTE: It is normal for the fuel filter to rattle in the empty fuel tank.

ASSEMBLY

⚠ WARNING: Stop engine and be sure the impeller blades have stopped turning before opening the vacuum inlet door or attempting to insert or remove the vacuum tubes. The rotating blades can cause serious injury.

⚠ WARNING: If you receive your unit assembled, repeat all steps to ensure your unit is properly assembled and all fasteners are secure.

- A standard screwdriver is required for assembly.

BLOWER ASSEMBLY

BLOWER TUBE ASSEMBLY

If you have already assembled your unit for use as a vacuum, remove the vacuum tubes and collection bag.

1. Align the rib on the upper blower tube with the groove in the blower outlet; slide the tube into place.

NOTE: Knob must be loose enough to allow blower tube to be inserted in blower outlet. Loosen knob by turning counterclockwise.

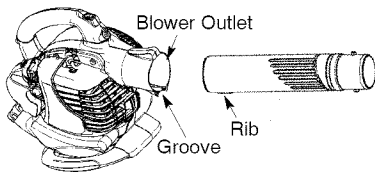

2. Secure the tube by turning the knob clockwise.
3. Align the slots on the lower blower tube with the tabs on the upper blower tube.

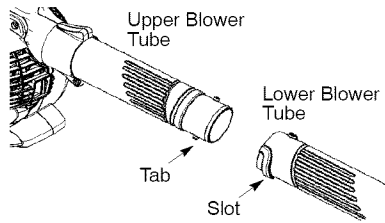

4. Slide the lower blower tube onto the upper blower tube.
5. Turn the lower blower tube clockwise until a click is felt to secure the lower blower tube to the upper blower tube.

NOTE: When the upper and lower blower tubes are assembled together properly, the arrows on both tubes will be aligned.

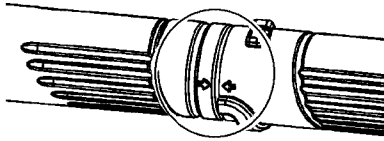

6. To remove the tubes, turn the knob counterclockwise to loosen the tubes; remove the tubes.

HIGH-SPEED NOZZLE ASSEMBLY

When greater air speed is desired, use the high-speed nozzle.

1. Align the slots on the nozzle with the tabs on the lower blower tube.

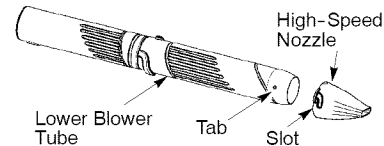

2. Slide the nozzle onto the lower blower tube.
3. Turn the nozzle clockwise until a click is felt to secure the nozzle to the lower blower tube.

VACUUM ASSEMBLY

VACUUM BAG ASSEMBLY

1. Open the zipper on the vacuum bag and insert the elbow tube.
2. Push the small end of the elbow tube through the small opening in the bag.

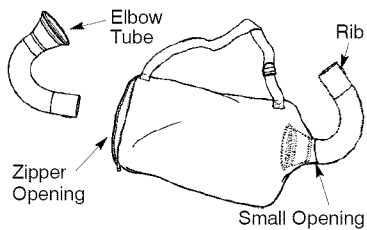

NOTE: Make sure edge of the small opening is flush against the flared area of the elbow tube, and the rib on the elbow tube is on the bottom.

3. Close the zipper on the bag. Make sure the zipper is closed completely.
4. Remove blower tubes from engine.

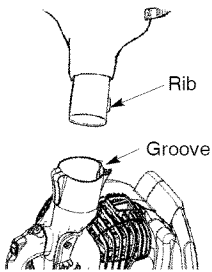

5. Insert the elbow tube into the blower outlet. Make sure elbow tube rib is aligned with the blower outlet groove.
6. Turn knob clockwise to secure elbow tube.

VACUUM TUBE ASSEMBLY

⚠ WARNING: Stop engine and be sure the impeller blades have stopped turning before opening the vacuum inlet door or attempting to insert or remove the vacuum or blower tubes. The rotating blades can cause serious injury.

1. Insert the tip of a screwdriver into the latch area of the vacuum inlet.

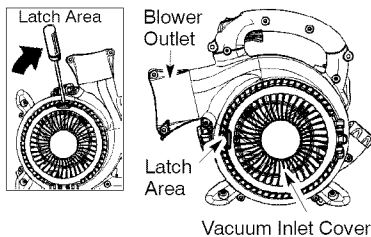

2. Gently tilt the handle of the screwdriver toward the front of the unit to release the latch while pulling up

on the vacuum inlet cover with your other hand.

3. Hold the vacuum inlet cover open until upper vacuum tube is installed.

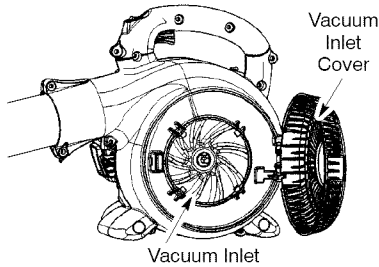

4. Align the tabs on the inside of the vacuum inlet with the slots in the upper vacuum tube.

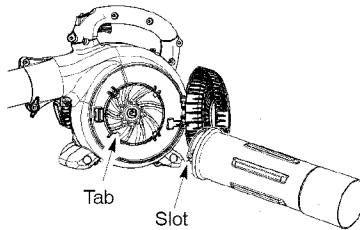

5. Push the upper vacuum tube into the vacuum inlet. Turn the tube counterclockwise until a click is felt to secure the tube to the blower unit.

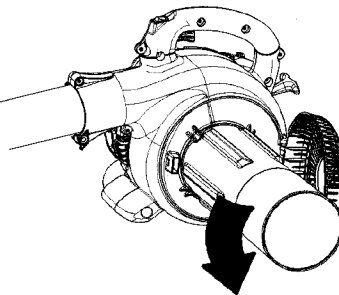

6. Align slanted end of lower vacuum tube as shown. Firmly push lower vacuum tube into upper vacuum tube.

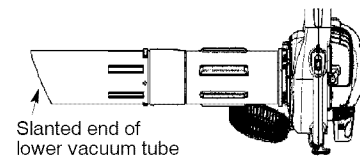

HOW TO CONVERT UNIT FROM VACUUM USE TO BLOWER USE

1. Remove the elbow tube and vacuum bag by turning the knob counterclockwise to loosen the elbow tube.
2. Remove the vacuum tubes by turning the tubes clockwise.
3. Close the vacuum inlet cover and make sure it is latched closed.
4. Reinstall the blower tubes (see BLOWER TUBE ASSEMBLY).

VACUUM BAG SHOULDER STRAP ADJUSTMENT

1. Hold the unit as shown with the muffler side facing away from your body and clothes.
2. Pass the shoulder strap over your head and onto your right shoulder.
3. Extend your left arm toward the rear of the vacuum bag.
4. Adjust shoulder strap until the vacuum bag/shoulder strap seam lies between your thumb and index finger.
5. Make sure air flows freely from the elbow tube into bag. If bag is kinked, the unit will not operate properly.



SHOULDER STRAP ATTACHMENT (optional accessory #71-85783)

1. Pass the shoulder strap over your head and onto your left shoulder.
2. Snap the hook onto the retainer (see following illustration).

BLOWER USE

Retainer

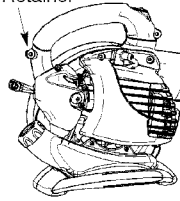

VACUUM USE

Retainer

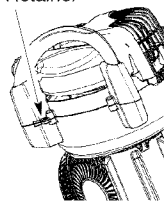

OPERATION

KNOW YOUR BLOWER

READ THIS OPERATOR'S MANUAL AND SAFETY RULES BEFORE OPERATING YOUR UNIT. Compare the illustrations with your unit to familiarize yourself with the location of the various controls and adjustments. Save this manual for future reference.

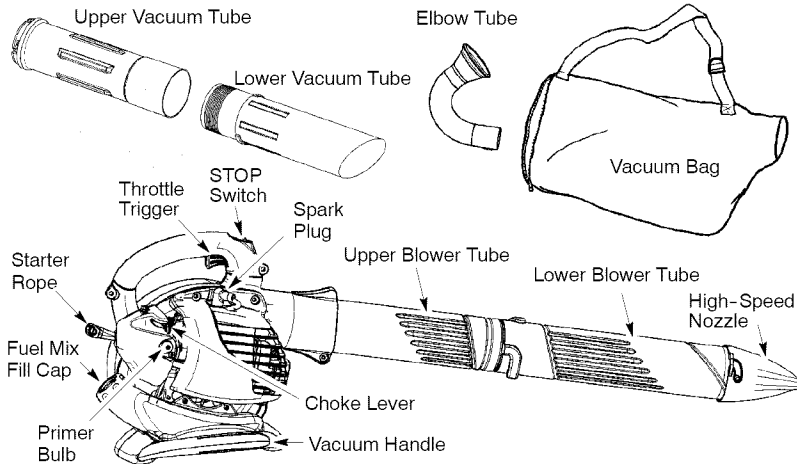

STOP SWITCH

The STOP switch is used to stop the engine. To stop the engine, push and hold the STOP switch in the STOP position until the engine stops.

THROTTLE TRIGGER

The THROTTLE TRIGGER is used to select the desired engine speed.

PRIMER BULB

The PRIMER BULB removes air from the carburetor and fuel lines and fills them with fuel. This allows you to start the en-

gine with fewer pulls on the starter rope. Activate primer bulb by pressing it and allowing it to return to its original position.

CHOKE LEVER

The CHOKE helps to supply fuel to the engine to aid in cold starting. Activate the choke by moving the choke lever to the FULL CHOKE position. After engine attempts to start, move the choke lever to the HALF CHOKE position. Once engine starts, move choke lever to the RUN position.

OPERATING TIPS

- While vacuuming or blowing debris, hold the unit with the muffler side facing away from your body and clothes (see OPERATING POSITION below).
- To reduce the risk of hearing loss associated with sound level(s), hearing protection is required.
- To reduce the risk of injury associated with contacting rotating parts, stop the engine before installing or removing attachments. Do not operate without guard(s) in place.
- Operate power equipment only at reasonable hours—not early in the morning or late at night when people might be disturbed. Comply with times listed in local ordinances. Usual recommendations are 9:00 a.m. to 5:00 p.m., Monday through Saturday.
- To reduce noise levels, limit the number of pieces of equipment used at any one time.
- To reduce noise levels, operate power blowers at the lowest possible throttle speed to do the job.
- Use rakes and brooms to loosen debris before blowing.
- In dusty conditions, slightly dampen surfaces or use a mister attachment when water is available.
- Conserve water by using power blowers instead of hoses for many lawn and garden applications, including areas such as gutters, screens, patios, grills, porches, and gardens.

- Watch out for children, pets, open windows, or freshly washed cars. Blow debris away safely.
- Use the full blower nozzle extension so the air stream can work close to the ground.
- After using blowers and other equipment, CLEAN UP! Dispose of debris in trash receptacles.

OPERATING POSITION

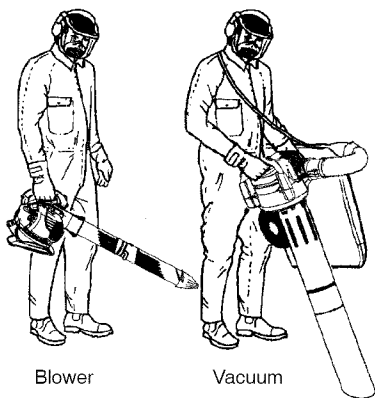

Blower

Vacuum

BEFORE STARTING ENGINE

WARNING: Be sure to read the fuel information in the safety rules before you begin. If you do not understand the safety rules, do not attempt to fuel your unit. Call 1-800-235-5878.

FUELING ENGINE

WARNING: Remove fuel cap slowly when refueling. This engine is certified to operate on unleaded gasoline. Before operation, gasoline must be mixed with a good quality synthetic 2-cycle air-cooled engine oil. We recommend Craftsman brand synthetic oil. Mix gasoline and oil at a ratio of 40:1. A 40:1 ratio is obtained by mixing 3.2 fluid ounces of oil with 1 gallon of unleaded gasoline. Included with this blower is a 3.2 ounce container of oil. Pour the entire contents of this container into 1 gallon of gasoline to achieve the proper fuel mixture. DO NOT USE automotive oil or boat oil. These oils will cause engine damage. When mixing fuel, follow instructions printed on container. Once oil is added to gasoline, shake container momentarily to assure that the fuel is thoroughly mixed. Always read and follow the safety rules relating to fuel before fueling your unit.

CAUTION: Never use straight gasoline in your unit. This will cause permanent engine damage and void the limited warranty.

FUEL REQUIREMENTS

This engine requires the use of minimum 87 octane [R+M]/2 clean gasoline.

IMPORTANT

Use of alcohol blended fuels (called gasohol or using ethanol or methanol) can cause major engine performance and durability problems.

WARNING: Alternative fuels (not gasoline) such as E-15 (15% alcohol), E-20 (20% alcohol), E-85 (85% alcohol) are NOT classified as gasoline and are NOT approved for use in 2-stroke gasoline engines. Use of alternative fuels will cause problems such as: improper clutch engagements, overheating, vapor lock, power loss, lubrication deficiency, deterioration of fuel lines, gaskets and internal carburetor components, etc. Alternative fuels cause high moisture absorption into the fuel/oil mixture leading to oil and fuel separation.

HOW TO STOP YOUR ENGINE

- Release the throttle trigger.
- Push and hold the STOP switch in the STOP position until the engine stops.

HOW TO START YOUR ENGINE

WARNING: You MUST make sure the tubes are secure before using the unit.

- Fuel engine. Move at least 10 feet (3 meters) away from the fueling site.
- Hold the unit in the starting position as shown. Make sure the blower end is directed away from people, animals, glass, and solid objects.

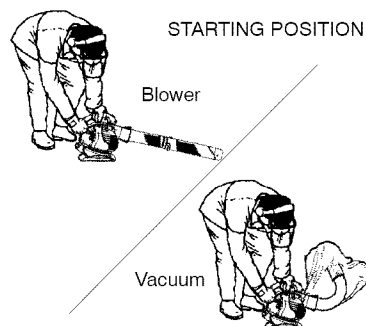

Blower

Vacuum

⚠ WARNING: When starting engine, hold the unit as illustrated. Do not set unit on any surface except a clean, hard area when starting engine or while engine is running. Debris such as gravel, sand, dust, grass, etc. could be picked up by the air intake and thrown out through the discharge opening, damaging the unit or property, or causing serious injury to bystanders or the operator.

STARTING A COLD ENGINE (or warm engine after running out of fuel)

1. Slowly press the primer bulb 6 times.
2. Move choke lever to the FULL CHOKE position.
3. Squeeze the throttle trigger fully and hold through *all remaining steps*.

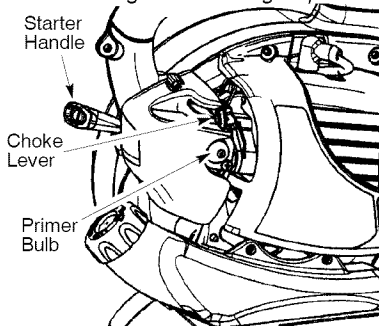

4. This unit has the Sim-pul™ starting system. You do not have to pull the starter rope handle sharply or briskly. Pull starter rope handle with a controlled and steady motion until engine sounds as if it is trying to start, but do not pull rope more than 6 times.
5. As soon as engine sounds as if it is trying to start, move choke lever to HALF CHOKE position.
6. Pull starter rope until engine runs, but no more than 6 pulls. **NOTE:** If the engine doesn't start after 6 pulls (at the HALF CHOKE position), move the choke lever to the FULL CHOKE position and press the primer bulb 6 times. Squeeze and hold the throttle trigger and pull the starter rope 2 more times. Move the choke lever to the HALF CHOKE position and pull the starter rope until the engine runs, but no more than 6 pulls. If the engine still doesn't start, it is probably flooded. Proceed to STARTING A FLOODED ENGINE.

7. Once the engine starts, allow it to run 10 seconds, then move the choke lever to the RUN position. Allow the unit to run for 30 more seconds at RUN before releasing the throttle trigger. **NOTE:** If engine dies with the choke lever in the RUN position, move the choke lever to the HALF CHOKE position and pull the rope until engine runs, but no more than 6 pulls.

STARTING A WARM ENGINE

1. Move the choke lever to the HALF CHOKE position.
2. Squeeze the throttle trigger fully and hold through *all remaining steps*.
3. Pull starter rope with a controlled and steady motion until engine runs, but no more than 6 pulls.
4. Allow engine to run 15 seconds, then move the choke lever to RUN.

NOTE: If engine has not started, pull starter rope 5 more pulls. If engine still does not run, it is probably flooded.

STARTING A FLOODED ENGINE

Flooded engines can be started by placing the choke lever in the RUN position; then, pull the rope to clear the engine of excess fuel. This could require pulling the starter handle many times depending on how badly the unit is flooded. If the unit still doesn't start, refer to TROUBLESHOOTING TABLE or call 1-800-235-5878.

MAINTENANCE

CUSTOMER RESPONSIBILITIES

⚠ WARNING: Disconnect the spark plug before performing maintenance, service, or adjustments.

CARE & MAINTENANCE TASK	WHEN TO PERFORM
Check for loose fasteners and parts	Before each use
Check for damaged or worn parts	Before each use
Inspect and clean unit and labels	After each use
Clean air filter	Every 5 hours of operation
Replace spark plug	Yearly
Replace fuel filter	Yearly
Check muffler mounting screws	Yearly

⚠ WARNING: Avoid touching muffler unless engine and muffler are cold. A hot muffler can cause serious burns.

⚠ WARNING: Stop engine and be sure the impeller blades have stopped turning before opening the vacuum inlet door or attempting to insert or remove the vacuum or blower tubes. The rotating blades can cause serious injury. Always disconnect the spark plug before performing maintenance or accessing movable parts.

GENERAL RECOMMENDATIONS

The warranty on this unit does not cover items that have been subjected to operator abuse or negligence. To receive full value from the warranty, the operator must maintain unit as instructed in this manual. Various adjustments will need to be made periodically to properly maintain your unit.

CHECK FOR LOOSE FASTENERS AND PARTS

- Muffler
- Spark Plug Boot
- Air Filter
- Housing Screws

CHECK FOR DAMAGED OR WORN PARTS

- Contact Sears Service Center for replacement of damaged or worn parts.
- Fuel Tank - Do not use unit if fuel tank shows signs of damage or leaks.
 - Vacuum Bag - Do not use vacuum bag if it is torn or damaged.

INSPECT AND CLEAN UNIT AND LABELS

- After each use, inspect complete unit for loose or damaged parts. Clean the unit using a damp cloth with a mild detergent.
- Wipe off unit with a clean dry cloth.

CLEAN AIR FILTER

A dirty air filter decreases engine performance and increases fuel consumption and harmful emissions. Always clean after every 5 hours of operation.

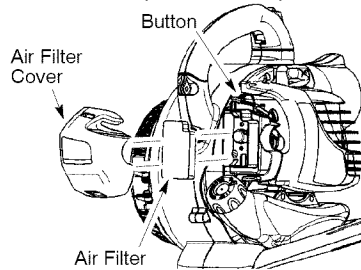

Cleaning the air filter:

1. Clean the cover and the area around it to keep debris from falling into the carburetor chamber when the cover is removed.

NOTE: Move choke lever to RUN position before opening air filter cover.

2. Open air filter cover by pushing button (see illustration). Remove air filter.

NOTE: Do not clean filter in gasoline or other flammable solvent. Doing so can create a fire hazard or produce harmful evaporative emissions.

3. Wash the filter in soap and water.
4. Allow filter to dry.
5. Apply a few drops of oil to the filter; squeeze filter to distribute oil.
6. Replace parts.

REPLACE SPARK PLUG

Replace spark plug each year to ensure the engine starts easier and runs better. Set spark plug gap at 0.025 inch. Ignition timing is fixed, nonadjustable.

1. Twist, then pull off spark plug boot.
2. Remove spark plug from cylinder and discard.
3. Replace with Champion RCJ-6Y spark plug and tighten securely with a 3/4 inch socket wrench.
4. Reinstall the spark plug boot.

REPLACE FUEL FILTER

To replace fuel filter, drain unit by running it dry of fuel, then remove fuel cap/retainer assembly from tank. Pull filter from tank and remove it from the fuel line. Install new fuel filter on fuel line; reinstall parts.

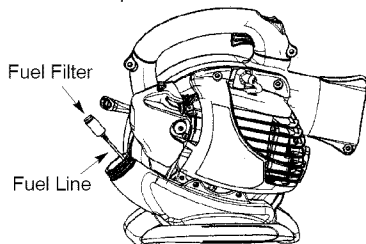

CHECK MUFFLER MOUNTING SCREWS

Once each year, ensure muffler mounting screws are secure and tightened properly to prevent damage.

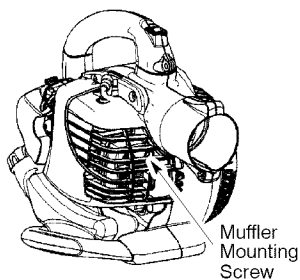

INSPECT MUFFLER AND SPARK ARRESTING SCREEN

⚠ WARNING: The muffler on this product contains chemicals known to the State of California to cause cancer.

As the unit is used, carbon deposits build up on the muffler and spark arresting screen, and must be removed to avoid creating a fire hazard or affecting engine performance.

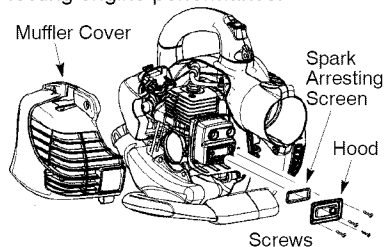

Replace the spark arresting screen every 50 hours of operation or if any damage or breaks in the screen are noted.

NOTE: Do not attempt to clean the spark arresting screen.

1. Remove 3 screws from muffler cover. Remove muffler cover.
2. Loosen and remove 4 screws from the muffler hood.
3. Remove the muffler hood and spark arresting screen.
4. Install new spark arresting screen.
5. Reinstall muffler hood and 4 screws. Tighten screws securely.
6. Reinstall muffler cover and 3 screws. Tighten securely.

NOTE: If any part of the muffler is cracked, broken or damaged, we recommend that the muffler be replaced.

CARBURETOR IDLE SPEED ADJUSTMENT

The carburetor has been carefully set at the factory. Adjustments may be necessary if you notice any of the following conditions:

- Engine will not idle when the throttle is released.

To adjust idle speed:

Allow engine to idle. Adjust speed until engine runs without stalling (idle speed too slow).

- Turn idle speed screw clockwise to increase engine speed if engine stalls or dies.
- Turn idle speed screw counterclockwise to decrease engine speed.

Idle Speed Screw

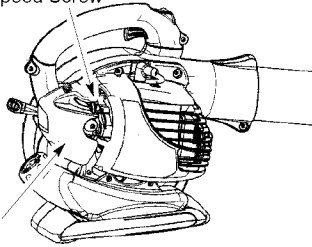

Air
Filter
Cover

If you require further assistance or are unsure about performing this procedure, contact your Sears Service Center or call our customer assistance help line at 1-800-235-5878.

STORAGE

⚠ WARNING: Perform the following steps after each use:

- Allow engine to cool, and secure the unit before storing or transporting.
- Store unit and fuel in a well ventilated area where fuel vapors cannot reach sparks or open flames from water heaters, electric motors or switches, furnaces, etc.
- Store unit with all guards in place. Position unit so that any sharp object cannot accidentally cause injury.
- Store unit and fuel well out of the reach of children.

SEASONAL STORAGE

Prepare unit for storage at end of season or if it will not be used for 30 days or more.

If your unit is to be stored for a period of time:

- Clean the entire unit before lengthy storage.
- Store in a clean dry area.
- Lightly oil external metal surfaces.

FUEL SYSTEM

Empty the fuel system before storage for 30 days or longer. Drain the gas tank, start the engine and let it run until the fuel lines and carburetor are empty. Use fresh fuel next season. Under FUELING ENGINE in the OPERATION section of this manual, see message labeled **IMPORTANT** regarding the use of gasoline in your engine.

Fuel stabilizer is an acceptable alternative in minimizing the formation of fuel gum deposits during storage. Add stabilizer to gasoline in fuel tank or fuel storage container. Follow the mix instructions found on stabilizer container. Run engine at least 3 minutes after adding stabilizer.

Craftsman 40:1, 2-cycle engine oil (air cooled) is already blended with fuel stabilizer. If you do not use this Sears oil, you can add a fuel stabilizer to your fuel tank.

ENGINE

- Remove spark plug and pour 1 teaspoon of 40:1, 2-cycle engine oil (air cooled) through the spark plug opening. Slowly pull the starter rope 8 to 10 times to distribute oil.
- Replace spark plug with new one of recommended type and heat range.
- Clean air filter.
- Check entire unit for loose screws, nuts, and bolts. Replace any damaged, broken, or worn parts.
- At the beginning of the next season, use only fresh fuel having the proper gasoline to oil ratio.

OTHER

- Do not store gasoline from one season to another.
- Replace your gasoline can if it starts to rust.

TROUBLESHOOTING TABLE

⚠ WARNING: Always stop unit and disconnect spark plug before performing any of the recommended remedies below other than remedies that require operation of the unit.

TROUBLE	CAUSE	REMEDY
Engine will not start.	<ol style="list-style-type: none"> 1. Engine flooded. 2. Fuel tank empty. 3. Spark plug not firing. 4. Fuel not reaching carburetor. 5. Compression low. 	<ol style="list-style-type: none"> 1. See "Starting a Flooded Engine" in Operation section. 2. Fill tank with correct fuel mixture. 3. Install new spark plug. 4. Check for dirty fuel filter; replace. Check for kinked or split fuel line; repair or replace. 5. Contact Sears Service (see back cover).
Engine will not idle properly.	<ol style="list-style-type: none"> 1. Fuel not reaching carburetor. 2. Carburetor requires adjustment. 3. Crankshaft seals worn. 4. Compression low. 	<ol style="list-style-type: none"> 1. Check for dirty fuel filter; replace. Check for kinked or split fuel line; repair or replace. 2. See "Carburetor Idle Speed Adjustment" in Service and Adjustments Section. 3. Contact Sears Service (see back cover). 4. Contact Sears Service (see back cover).
Engine will not accelerate, lacks power, or dies under a load.	<ol style="list-style-type: none"> 1. Air filter dirty. 2. Fuel not reaching carburetor. 3. Spark plug fouled. 4. Carburetor requires adjustment. 5. Carbon build up. 6. Compression low. 	<ol style="list-style-type: none"> 1. Clean or replace air filter. 2. Check for dirty fuel filter; replace. Check for kinked or split fuel line; repair or replace. 3. Clean or replace spark plug and re-gap. 4. Contact Sears Service (see back cover). 5. Contact Sears Service (see back cover). 6. Contact Sears Service (see back cover).
Engine smokes excessively.	<ol style="list-style-type: none"> 1. Choke partially on. 2. Fuel mixture incorrect. 3. Air filter dirty. 4. Carburetor requires adjustment. 	<ol style="list-style-type: none"> 1. Adjust choke. 2. Empty fuel tank and refill with correct fuel mixture. 3. Clean or replace air filter. 4. Contact Sears Service (see back cover).
Engine runs hot.	<ol style="list-style-type: none"> 1. Fuel mixture incorrect. 2. Spark plug incorrect. 3. Carburetor requires adjustment. 4. Carbon build up. 	<ol style="list-style-type: none"> 1. See "Fueling Engine" in Operation section. 2. Replace with correct spark plug. 3. Contact Sears Service (see back cover). 4. Contact Sears Service (see back cover).

U.S. EPA/CALIFORNIA EMISSION CONTROL WARRANTY STATEMENT

YOUR WARRANTY RIGHTS AND OBLIGATIONS: The U.S. Environmental Protection Agency/California Air Resources Board and Sears, Roebuck and Co., U.S.A., are pleased to explain the emissions control system warranty on your year 2009 and later small off-road engine. In California, all small off-road engines must be designed, built, and equipped to meet the State's stringent anti-smog standards. Sears must warrant the emission control system on your small off-road engine for the periods of time listed below provided there has been no abuse, neglect, or improper maintenance of your small off-road engine. Your emission control system includes parts such as the carburetor, the ignition system and the fuel tank. Where a warrantable condition exists, Sears will repair your small off-road engine at no cost to you. Expenses covered under warranty include diagnosis, parts and labor. **MANUFACTURER'S WARRANTY COVERAGE:** If any emissions related part on your engine (as listed under Emissions Control Warranty Parts List) is defective or a defect in the materials or workmanship of the engine causes the failure of such an emission related part, the part will be repaired or replaced by Sears. **OWNER'S WARRANTY RESPONSIBILITIES:** As the small off-road engine owner, you are responsible for the performance of the required maintenance listed in your operator's manual. Sears recommends that you retain all receipts covering maintenance on your small off-road engine, but Sears cannot deny warranty solely for the lack of receipts or for your failure to ensure the performance of all scheduled maintenance. As the small off-road engine owner, you should be aware that Sears may deny you warranty coverage if your small off-road engine or a part of it has failed due to abuse, neglect, improper maintenance, unapproved modifications, or the use of parts not made or approved by the original equipment manufacturer. You are responsible for presenting your small off-road engine to a Sears authorized repair center as soon as a problem exists. Warranty repairs should be completed in a reasonable amount of time, not to exceed 30 days. If you have any questions regard-

ing your warranty rights and responsibilities, you should contact your nearest authorized service center, call Sears at 1-800-469-4663, or send e-mail correspondence to emission_warranty@HCOP-emission.com. **WARRANTY COMMENCEMENT DATE:** The warranty period begins on the date the small off-road engine is purchased. **LENGTH OF COVERAGE:** This warranty shall be for a period of two years from the initial date of purchase. **WHAT IS COVERED: REPAIR OR REPLACEMENT OF PARTS.** Repair or replacement of any warranted part will be performed at no charge to the owner at an approved Sears Service Center. If you have any questions regarding your warranty rights and responsibilities, you should contact your nearest authorized service center, call Sears at 1-800-469-4663, or send e-mail correspondence to emission_warranty@HCOP-emission.com. **WARRANTY PERIOD:** Any warranted part which is not scheduled for replacement as required maintenance, or which is scheduled only for regular inspection to the effect of "repair or replace as necessary" shall be warranted for 2 years. Any warranted part which is scheduled for replacement as required maintenance shall be warranted for the period of time up to the first scheduled replacement point for that part. **DIAGNOSIS:** The owner shall not be charged for diagnostic labor which leads to the determination that a warranted part is defective if the diagnostic work is performed at an approved Sears Service Center. **CONSEQUENTIAL DAMAGES:** Sears may be liable for damages to other engine components caused by the failure of a warranted part still under warranty. **WHAT IS NOT COVERED:** All failures caused by abuse, neglect, or improper maintenance are not covered. **ADD-ON OR MODIFIED PARTS:** The use of add-on or modified parts can be grounds for disallowing a warranty claim. Sears is not liable to cover failures of warranted parts caused by the use of add-on or modified parts. **HOW TO FILE A CLAIM:** If you have any questions regarding your warranty rights and responsibilities, you should contact your nearest authorized service center, call Sears at 1-800-469-4663, or send

e-mail correspondence to emission_warranty@HCOP-emission.com.
WHERE TO GET WARRANTY SERVICE: Warranty services or repairs shall be provided at all Sears Service Centers. Call 1-800-469-4663 or send e-mail correspondence to emission_warranty@HCOP-emission.com.
MAINTENANCE, REPLACEMENT AND REPAIR OF EMISSION RELATED PARTS: Any Sears approved replacement part used in the performance of any warranty maintenance or

repair on emission related parts will be provided without charge to the owner if the part is under warranty. **EMISSION CONTROL WARRANTY PARTS LIST:** Carburetor, air filter (covered up to maintenance schedule), ignition system: spark plug (covered up to maintenance schedule), ignition module, muffler including catalyst (if equipped), fuel tank.
MAINTENANCE STATEMENT: The owner is responsible for the performance of all required maintenance as defined in the operator's manual.

The information on the product label indicates which standard your engine is certified. Example: (Year) EPA and/or CALIFORNIA.

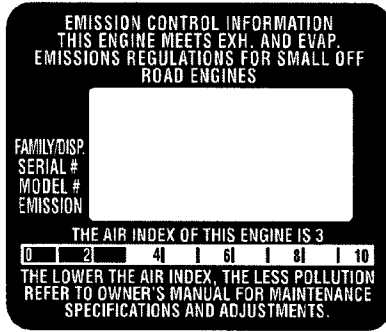

This engine is certified to be emissions compliant for the following use:

- Moderate (50 hours)
- Intermediate (125 hours)
- Extended (300 hours)