

## Portable Ice Maker



**OWNERS MANUAL v1.0**

*Read and save these instructions.*



# A Name You Can Trust

Trust should be earned and we will earn yours. Customer happiness is the focus of our business.

From the factory to the warehouse, from the sales floor to your home, the whole NewAir family promises to provide you with innovative products, exceptional service, and support when you need it the most.

## Count on NewAir.

As a proud NewAir owner, welcome to our family. There are no robots here, real people shipped your product and real people are here to help you.

## Contact Us:

For questions regarding your product, please contact us at:

**Call:** 1-855-963-9247  
**Email:** support@newair.com  
**Online:** www.newair.com

## Connect with Us:



Facebook.com/newairusa



Instagram.com/newairusa



YouTube.com/newairusa



Twitter.com/newairusa

For future reference, we recommend you attach a copy of your sales receipt here and record the following information. You will need this information if it becomes necessary to contact the manufacturer for service inquiries.

Date of Purchase: \_\_\_\_\_

Serial Number: \_\_\_\_\_

Model Number: \_\_\_\_\_

<http://www.NewAir.com>

## REGISTER YOUR PRODUCT ONLINE

### Register Your NewAir Product Online Today!

Take advantage of all the benefits product registration has to offer:



#### Service and Support

Diagnose troubleshooting and service issues faster and more accurately



#### Recall Notifications

Stay up to date for safety, system updates and recall notifications



#### Special Promotions

Opt-in for NewAir promotions and offers

Registering your product information online is safe & secure and takes less than 2 minutes to complete:

[Register.NewAir.com](https://Register.NewAir.com)

Alternatively, we recommend you attach a copy of your sales receipt below and record the following information, located on the manufacturer's nameplate on the rear of the unit. You will need this information if it becomes necessary to contact the manufacturer for service inquiries.

**Date of Purchase:** \_\_\_\_\_

**Serial Number:** \_\_\_\_\_

**Model Number:** \_\_\_\_\_

Love Your Home

# READ AND SAVE THESE INSTRUCTIONS.

## TABLE OF CONTENTS

Safety Information & Warnings .....	5
Parts List.....	6
Basic Parts Diagram .....	6
Control Panel Diagram .....	8
Assembly & Installation .....	9
Operating Instructions .....	10
Making Ice.....	10
Using the Timer .....	11
Cleaning & Maintenance.....	12
Storage .....	13
Troubleshooting.....	13
Limited Manufacturer's Warranty .....	16

## SPECIFICATIONS

<b>MODEL NO.</b>	AI-215
<b>RATED VOLTAGE:</b>	115V / 60Hz
<b>CURRENT:</b>	2.1/3.2 amps
<b>POWER CONSUMPTION:</b>	170 watts
<b>CAPACITY (DAILY):</b>	50 pounds
<b>CAPACITY (PER CYCLE):</b>	12 pieces
<b>ICE SIZES:</b>	3

## SAFETY INFORMATION & WARNINGS

As with any electrical appliance, basic safety precautions must be followed in order to reduce the risk of fire, electrical shock and/or injury to persons or property. Be sure to read all instructions before using this appliance and observe the following safety tips:



- Do not operate this appliance if it has a damaged cord.
- Only connect the ice maker to a properly polarized outlet. No other appliance should be plugged into the same outlet. Make sure the plug is fully inserted into the receptacle.
- An extension cord is not recommended, as it may overheat and become a fire risk. If necessary, use an extension cord with a minimum size of No. 14 AWG and rated for no less than 1875 watts.
- Do not place hands or objects on or near the ice maker's evaporator when it is in operation.
- Do not run the power cord over carpeting or heat insulators. Do not cover the cord. Keep the cord away from high traffic areas and never submerge it in water.
- Always turn off and unplug the ice maker from the power supply before cleaning and servicing.
- Do not use your ice maker outdoors.
- Do not use liquids other than water to make ice cubes.
- Exercise caution and make sure there is supervision when this appliance is being used near children.
- If the ice maker is brought in from the outside in the winter, allow the ice maker to warm up to your room's temperature for a few hours before plugging it in.
- Do not clean your ice maker with flammable fluids. The fumes can create a fire hazard or cause an explosion.

Do not touch the evaporator while the unit is in use or during the ice making process. It may cause severe burning.



## PARTS LIST

### BASIC PARTS DIAGRAM



1. Cover
2. Control Panel
3. Water Drain Cap
4. Ice Basket
5. Ice Scoop
6. Ice Shovel
7. Handle

<http://www.NewAir.com>

## FULL PARTS DIAGRAM

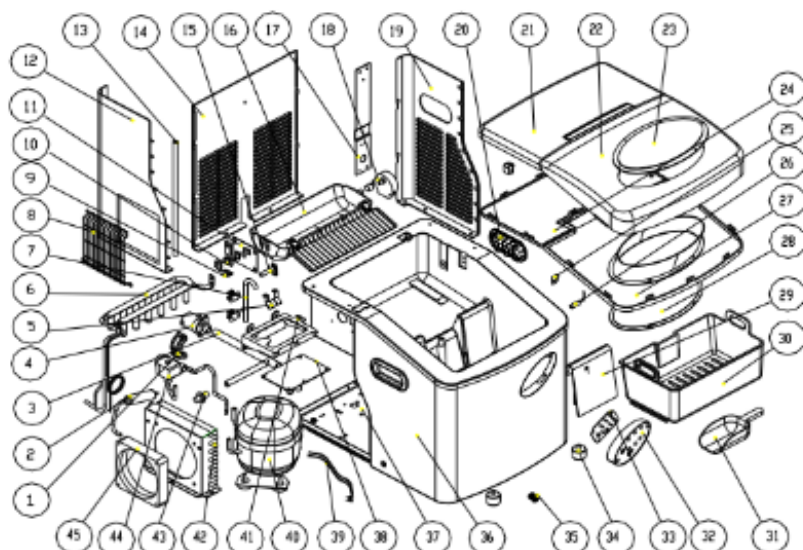

- |                                     |                                   |
|-------------------------------------|-----------------------------------|
| 1. Fixing set for water pump        | 24. Back down cover               |
| 2. Refrigerant dry filter           | 25. Detector pressing pat         |
| 3. Silicon pipe for supplying water | 26. Water full temperature sensor |
| 4. V/Water pump                     | 27. Front down cover              |
| 5. Water detecting piece            | 28. Down window                   |
| 6. Evaporator assembly              | 29. Ice apron                     |
| 7. Steel pipe for supplying water   | 30. Ice basket                    |
| 8. Steel grill                      | 31. Ice shove                     |
| 9. Cam                              | 32. Operation panel frame         |
| 10. Micro switch                    | 33. Button PWB                    |
| 11. Install panel of switch         | 34. Rubber feet with bolts        |
| 12. Left panel                      | 35. Water filter                  |
| 13. Silicon pipe for ice-making box | 36. Fomaing assembly              |
| 14. Rear panel                      | 37. Bottom base                   |
| 15. Ice making box axis             | 38. Main control PWB              |
| 16. Ice making box assembly         | 39. power line and clip           |
| 17. Back down cover                 | 40. Compressor                    |
| 18. Synchronous motor               | 41. Electrical box                |
| 19. Right panel                     | 42. Condenser                     |
| 20. Hand dug                        | 43. Water draining assembly       |
| 21. Back up cover                   | 44. Electromagnet valve assembly  |
| 22. Front up cover                  | 45. DC12V/Fan blade               |
| 23. Up window                       | 46. Inner lead                    |

## WIRING DIAGRAM

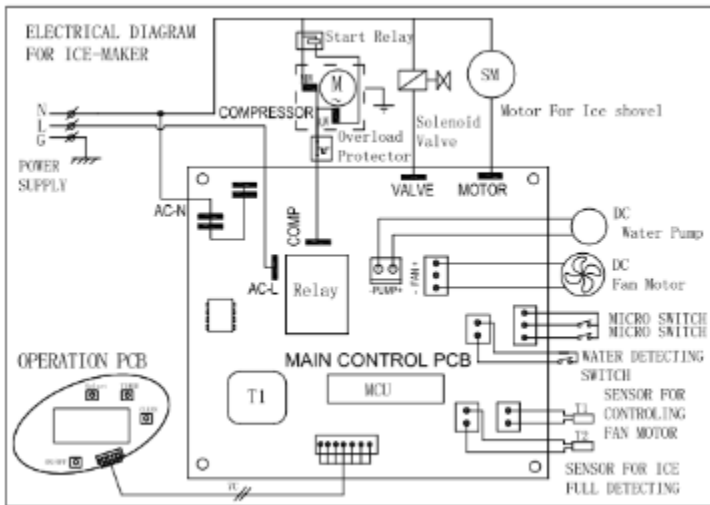

## CONTROL PANEL DIAGRAM



### BUTTONS:

**ON/OFF** – Use to start or stop the unit







**SELECT** - Selects ice size

**TIMER** – Set or cancel timer (refer to page 9)

<http://www.NewAir.com>

**CLEAN** – Begin self-cleaning function (refer to page 7)

**LCD DISPLAY SYMBOLS:**

	Power indicator		Ice Bucket Full Indicator
	Ice size selected (small, medium or large)		Add Water Indicator (flashes when water needs to be added)
	Timer display		Warning Indicator – problem with unit
			Self-Cleaning Indicator

## ASSEMBLY & INSTALLATION

1. Remove the exterior and interior packaging. Check that the ice basket and ice scoop are included. If any parts are missing, please contact customer service.
2. Clean the interior with lukewarm water and a soft cloth. Take out the ice basket and clean it.
3. Place your ice maker in a location that is protected from direct sunlight and other heat sources (e.g., stove, furnace, and radiator). Make sure it is on a level surface with at least 4 inches of space between the back and sides of the unit and the wall.
4. Allow two hours for the refrigerant fluid to settle in the compressor before plugging the ice maker in.

Love Your Home



**NOTICE:** After unpacking your ice maker, it must rest in an upright position for at least two hours before you plug it in or the compressor may be damaged, shortening the life span of the unit.

5. Plug your appliance into an exclusive, properly installed and grounded wall outlet. Do not under any circumstances cut or remove the third (ground) prong from the power cord. Any questions concerning power and/or grounding should be directed to a certified electrician.

We recommend you clean your ice maker thoroughly before using it. Please see Cleaning & Maintenance on page 10 of this guide.

## OPERATING INSTRUCTIONS

### MAKING ICE

1. Open the unit's cover, remove the ice basket, and pour water into the water reservoir. Keep the water level below the "MAX" line marked inside the reservoir.
2. Plug in the unit to the grounded power supply outlet.
3. Press the "ON/OFF" button on the control panel to begin the ice making cycle.
4. Select the size of the ice cube by pressing the "SELECT" button. If the room temperature is lower than 60°F, it is recommended to select small or medium ice in order to avoid the ice sticking together.
5. The ice making cycle lasts anywhere from 7 to 13 minutes, depending on the size of the ice cubes you select and the ambient room temperature. Ice making time may vary significantly in extremely high room temperatures.
6. Periodically verify the water level in the water reservoir when the ice maker is on. If the water level is too low, the ice maker will automatically

<http://www.NewAir.com>

stop and the “Add Water” indicator light will flash in the LCD display window. Press the “POWER” button to stop the unit and unplug it. Fill the reservoir with water up to the level mark. Plug it in and press the “POWER” button again to restart the unit. **Allow at least 3 minutes for the refrigerant inside the compressor to settle before restarting.**

7. The ice maker automatically stops working when the ice basket is full. The “Ice Bucket Full” indicator will also turn on at this time.
8. Change the water in the reservoir every 24 hours to ensure hygienic ice. If the ice maker will not be used for an extended period of time, drain the water from the reservoir by unplugging the drain off cap located on the side of the ice maker.

---

## USING THE TIMER

### How to Set the ON-TIMER Program

When the unit is off, you can program the timer to start the unit after a set number of hours.

1. Press the TIMER button on the control panel. “1.0H” will flash in the Timer Set Display Window.
2. Press the SELECT button to set the Timer delay to a time between 1.0 and 18.0 hours, in half hour increments.
3. After the desired time is set, the display will show the time remaining and will decrease in 0.1 hour increments. When the timer reaches ZERO and disappears, the unit will start to run automatically according to your settings.

To cancel when the time is set but not yet running, press the TIMER button twice to cancel it.

### How to Set the OFF-TIMER Program

When the unit is on, program the OFF-TIMER to stop the unit after a set time.

1. Press the TIMER button on the control panel. "1.0H" will flash in the Timer Set Display Window.
2. Press the SELECT button to set the Timer delay to a time between 1.0 and 18.0 hours, in half hour increments.
3. After the desired time is set, the display will show the time remaining and will decrease in 0.1 hour increments. When the timer reaches ZERO and disappears, the unit will stop running automatically.

To cancel while the unit is running, press the TIMER button twice to cancel the TIMER-OFF setting.

## CLEANING & MAINTENANCE

Clean the outside of the ice maker with a mild detergent solution and warm water. Use a soft cloth to wipe to avoid scratching or damaging the surface of the unit.

Use the unit's self-clean function to clean the interior of the unit:

1. Remove the ice basket.
2. Add 1:1 mixture of water and vinegar.
3. Plug in the unit. Hold down the CLEAN button for at least 6 seconds and release. The unit will automatically enter the self-clean program. This process will last about 5-6 minutes, after which the unit will automatically power down again. During this process the "Add Water Indicator" and the "Self Cleaning Indicator" will light in the LCD display window, and the fan blades in the self-clean symbol will always rotate. This process will rinse the inside parts of the ice maker thoroughly.
4. After the self-clean program is completed, drain out the water by unplugging the drain cap on the side. Then close the drain cap.
5. Unplug the unit and add fresh water into the interior tank, up to the water level mark.
6. Re-plug the unit to the power supply, and rerun the self-cleaning program again as described in Step 3.
7. When the self-cleaning program is completed, unplug the unit and drain out the water by unplugging the drain cap on the side.

8. Dry the interior and exterior with a soft cloth.
9. Tighten the drain cap. Replace the ice basket and plug the unit in again.

To remove the build-up of calcium or other impurities, add a capful of vinegar or lemon juice to the water in the reservoir and run for two or three ice-making cycles. Drain and refill the reservoir with clean, warm water. Run two more cycles to rinse the vinegar or lemon-juice.

When the machine is not in use open the water drain cap to completely drain the water reservoir.

## STORAGE

Before storing your ice maker, clean it according to the directions above and allow it to dry thoroughly – at least 24 hours – in order to prevent the growth of mold or mildew.

Store your ice maker in the original packaging, or cover with a soft cloth or plastic sheet.

## TROUBLESHOOTING

Problem	Possible Cause	Solution
The “ADD WATER” indicator light is on.	There is not enough water in the tank.	Press “POWER” to turn off the unit. Fill the reservoir with water. Press “POWER” to restart.
The “ICE BUCKET FULL” indicator light is on.	The ice basket is full.	Remove ice from the basket.
The “WARNING” indicator light is on.	Ice shovel cannot rotate.	Check if ice cubes are blocking the ice shovel; otherwise, consult a certified technician to check the motor and micro switch.

<b>Problem</b>	<b>Possible Cause</b>	<b>Solution</b>
<b>The “WARNING” indicator flashes for 20 seconds when starting or during operation.</b>	Ice-full detecting sensor on the edge of interior tank is malfunctioning.	Consult a qualified technician to check the sensor or change to a new one.
<b>Ice cubes stick together.</b>	The ice cycle is too long.	Stop the ice maker and allow ice block to melt. Select smaller size and restart.
	Water temperature in inner tank is too low.	Change the water in the inner tank. Temperature of water is best between 45°F - 90°F.
<b>The ice making cycle appears to be normal but no ice is being produced.</b>	The refrigerant may be leaking.	Consult a qualified technician.
	A pipe in the cooling system may be blocked.	Consult a qualified technician.
	Ambient temperature or water temperature in inner tank is too high.	Please run the ice maker below 90°F and pour colder water into the tank.
<b>The ice cubes are too small.</b>	The ambient temperature or water temperature may be too high.	Select large sized ice cubes by pressing the “SELECT” button.
	The compressor may need to warm up.	If this is the first time the unit is being used, allow the ice maker to cycle a few times. This should result in larger cubes.
<b>The ice has a “plastic” taste.</b>	The unit’s interior may need to be cleaned.	Add a tablespoon of lemon juice or vinegar to a full tank of water and allow the ice maker to cycle a few times.

<b>Problem</b>	<b>Possible Cause</b>	<b>Solution</b>
<b>The unit produces a large block of ice instead of cubes.</b>	The ambient temperature may be too low.	Unplug the unit and let the ice thaw out. Allow the ice maker to defrost for a few hours and restart the unit.
<b>The ice cubes have a cloudy appearance.</b>	There may be trace minerals in your water or ice is being produced too quickly.	Ice cubes may develop cloudiness when water is frozen quickly. As ice develops on the surface of water, certain gases can no longer remain dissolved and begin to surface as microscopic bubbles. This cloudiness is normal.

## LIMITED MANUFACTURER'S WARRANTY

This appliance is covered by a limited manufacturer's warranty. For one year from the original date of purchase, the manufacturer will repair or replace any parts of this appliance that prove to be defective in materials and workmanship, provided the appliance has been used under normal operating conditions as intended by the manufacturer.

### **Warranty Terms:**

During the first year, any components of this appliance found to be defective due to materials or workmanship will be repaired or replaced, at the manufacturer's discretion, at no charge to the original purchaser. The purchaser will be responsible for any removal or transportation costs.

### **Warranty Exclusions:**

The warranty will not apply if damage is caused by any of the following:

- Power failure
- Damage in transit or when moving the appliance
- Improper power supply such as low voltage, defective household wiring or inadequate fuses
- Accident, alteration, misuse or abuse of the appliance such as using non-approved accessories, inadequate air circulation in the room or abnormal operating conditions (extreme temperatures)
- Use in commercial or industrial applications
- Fire, water damage, theft, war, riot, hostility or acts of God such as hurricanes, floods, etc.
- Use of force or damage caused by external influences
- Partially or completely dismantled appliances
- Excess wear and tear by the user

### **Obtaining Service:**

When making a warranty claim, please have the original bill of purchase with purchase date available. Once confirmed that your appliance is eligible for warranty service, all repairs will be performed by a NewAir™ authorized repair facility. The purchaser will be responsible for any removal or transportation costs. Replacement parts and/or units will be new, re-manufactured or refurbished and is subject to the manufacturer's discretion. For technical support and warranty service, please email [support@newairusa.com](mailto:support@newairusa.com).

<http://www.NewAir.com>