



User guide



**MODEL
S600**

Table of Contents

Safety precautions.....	03
Product features.....	05
Installation instructions.....	07
Maintenance instructions.....	10
Troubleshooting.....	12
Warranty service.....	13
Packing list.....	13

Safety Precautions

Warning



Professional Services
Required



Disconnect power
supply during
installation
and maintenance



Do not use damaged
power cord



Only genuine
replacement can be
used



Do not contact
corrosive substances



Keep away from
the fire



No Heavy objects or
covering on top

* Do not open or modify the machine without permission. The installation, repairing and maintenance of the machine must be carried out by authorized competent person. A. O. Smith Corporation shall not responsible for any damages due installation, reparing or maintenance performed by unauthorised person. The factory shall not be responsible for the failure of the production to reach the normal state or performance due to the installation, repairing or maintenance without the authorized personnel of the factory.

* The limited liability warranty shall not cover any damages caused by unauthorized installation or maintenance and using non-genuine parts or accessories, including but not limited to the damages of product, personal and properties.

* Disconnect the power supply during installation and repiring. Do not touch the power supply with wet hands. Do not use damaged power supply components and it must be replaced by authorized competent person.

* Product can only be used under 220V power supply.

* Only original filter replacements can be used for the machines. The limited liability warranty will be void if non-genuine replacement be used. Please contact A. O. Smith when filters need to be replaced.

Safety Precautions

Attention



Sunlight



Do not expose to high temperature and humidity



Rinse the filter elements

- * The machine can be installed indoor only and it must not be exposed to direct sunlight.
- * This is ambient temperature, not inlet water temperature. if the inlet water temperature is 5 degree C, the unit can be used.
- * Please disconnect the water and power supply if machine will not be used for a period of time. When the machine has not been used for a while, always discharge water from machine at least 1 minute before consuming water from machine.
- * Please stop the water and power supply immediately under below circumstances:
 1. Water leakage from pipe or any part from machine.
 2. The machine is out of order.
 3. Electrical leakage of machine.
 4. Any abnormality or fault from machine.

Product features

Structural diagram

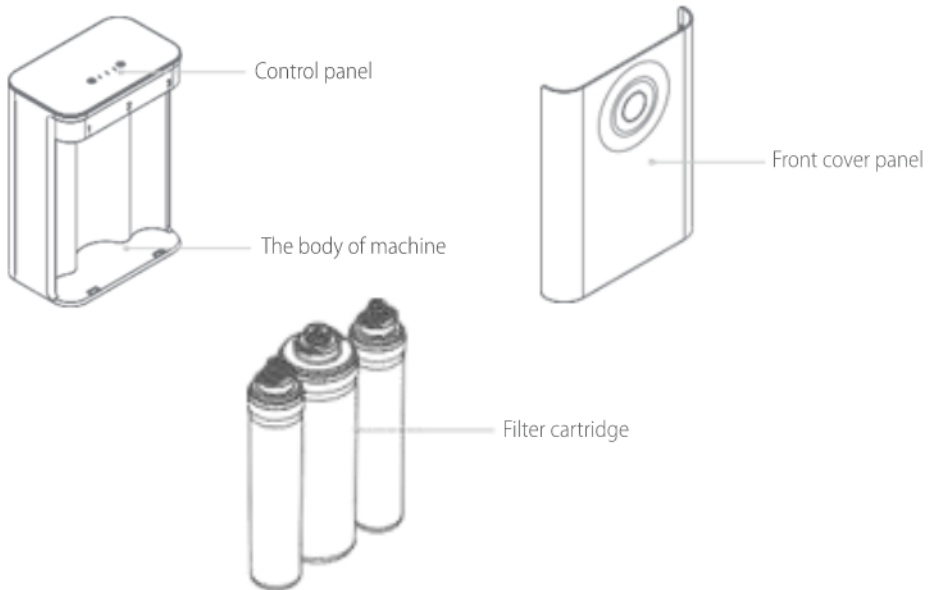

Display function description

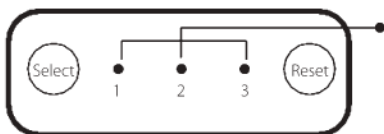

Filter replacement indicator:

- Filter 1: Composite filter
- Filter 2: RO side stream
- Filter 3: PAC filter

- Green: no replacement is needed.
- Orange: filters need to be replaced soon (when the filter life left $\leq 5\%$, the light get orange. so if the life time is 12 month, we suggest to replace it in half month).
- Red: filter need to be replaced immediately.



- White: no replacement is needed.
- Orange: filters need to be replaced soon (when the filter life left $\leq 5\%$, the light get orange. so if the life time is 12 month, we suggest to replace it in half month).
- Red: filter need to be replaced immediately.

Product features

Specification

A. O. Smith Corporation reserve the right to to modify product specification without prior notice.

* The claimed flow rate is under the condition of 25°C inlet temperature and 0.2MPa inlet temperature. The actual flow rate may vary when inlet temperature and pressure change.

* the rated total net water amount is tested in accordance with the requirements of the "code for hygienic safety and function evaluation of drinking water quality processors - reverse osmosis treatment overflow" (2001).

(7000L for 600G unit)

* unit conversion:

0.1MPa = 1.02KGF/cm² = 14.5psi

1psi = 0.07 KGF/cm²

Product model	S600
Water flow	600GPD (94L/h)
Rated power	65W
Feed water temperature	5-38oC
Feed water pressure	0.1- 0.35 MPa
Suitable feed water	Municipal water
Net weight	10.5 kg
Product Dimensions	310 x 185 x 430 (mm)

Water flow and electric diagram

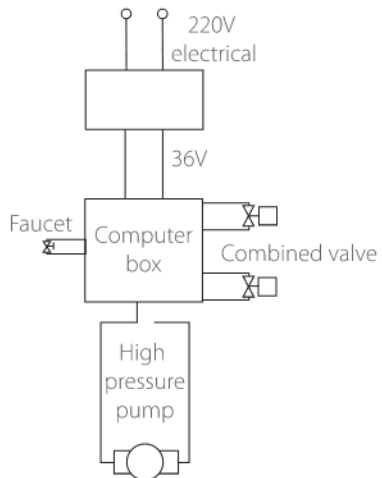
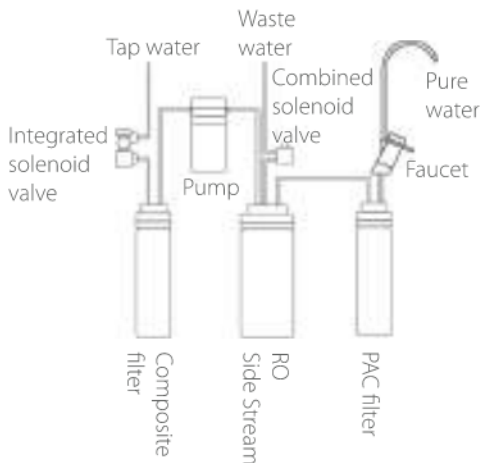

Installation instruction

Under no circumstance will A. O. SMITH Company be held liable for any damage that caused by failure to comply with the installation and operation instructions outlined in this manual. Only authorized competent person can perform the installation.

Installation steps

- Check the installation location
- Install Tee Stop Valve (suggest)
Stop the water supply. Install the tee stop valve between tap water inlet and tube to faucet. Insert PE pipe to water outlet.

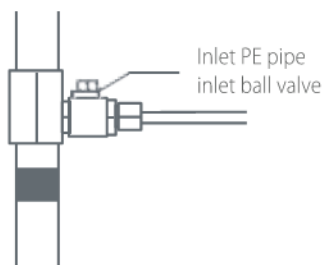
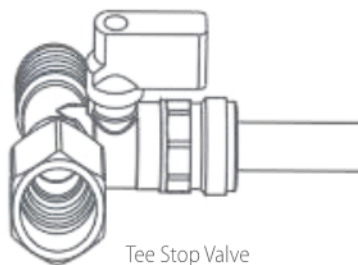

- Install two stage filter elements and RO filter.
- Connect the other parts basing on installation diagram.

Installation of filter element and reverse osmosis membrane

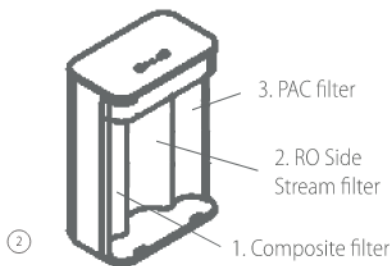
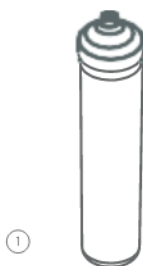

Installation instruction

Installation diagram

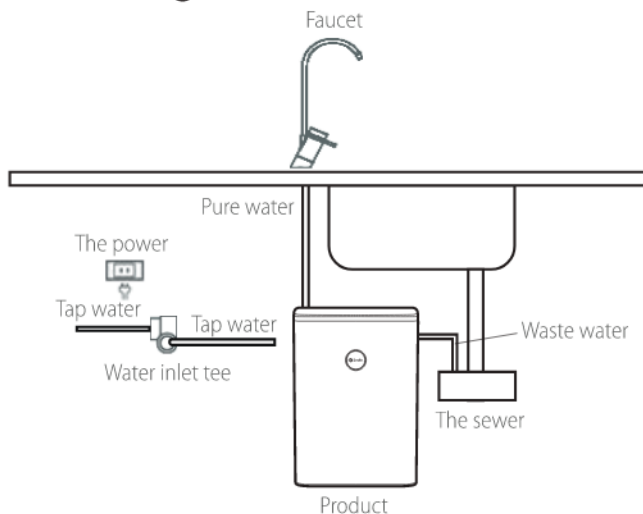

Installation of faucet

Attention: use clean sponge or soft cloth to wipe off grease on faucet. Do not use steel wool or rough objects to clear the faucet.

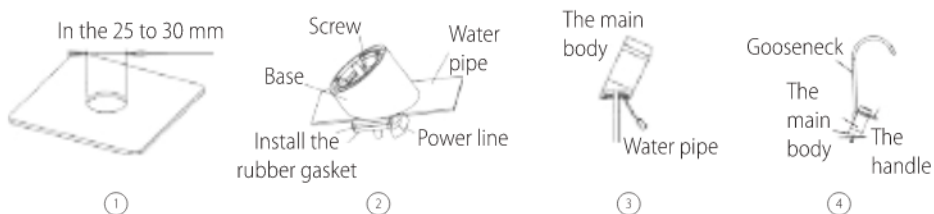

1	Drilling	Drill a hole - 25 to 30mm in the middle - where appropriate on the drawing table.
2	Installed base	Basing on below diagram.
3	Install the main body	Cut the pipe with appropriate length, insert one end into the quick connector on the faucet body, and insert the other end into the machine water outlet through the base. Connect, and then rotate the main body into the base, matching the base.
4	Install gooseneck	Insert the end of the o-ring into the outlet nozzle of the main body after dipping into the water, to complete the installatio of the faucet.

Installation instruction

Adjustment and use

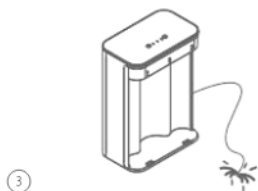
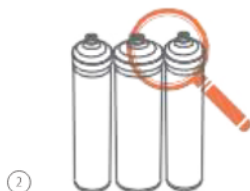
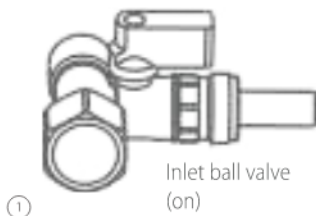

1	Power on, test function	Open the tap water inlet ball valve and the machine inlet ball valve, plug in the electricity, turn on the tap water, wait until the filter element is filled with water, and observe whether there is water flowing out.
2	Check leakage	When the machine is out of water and running steadily, check whether the inlet ball valve and joints of the machine are reliable, and whether the filter bottle joints are moist.
3	Close, test function	Turn off the faucet and wait for a while to check whether the concentrated water has stopped.
4	Flush	When you use this machine for the first time, it is recommended to discharge the water generated in the first 30 minutes at least until there is no visible object in the water, then it can be used normally.

Note

1. Due to the increase of gas solubility when tap water is filtered through high-pressure physical filter of water purifier, bubbles (similar to bubbles of carbonated drinks) will be generated when the pressure overflows when pure water flows out. As pure water has no impurities, bubbles will dissipate for a long time, which is a normal physical phenomenon and harmless to human body.
2. The RO membrane has been packed with antimicrobials agent to prevent it to be contaminated by microbial during storage and transportation. Please discharge water from machine after installation. Please refer to the above flushing procedure for details.

Filter life time and replacement

* The claimed life time of filters is for reference only. The actual life time of filter may vary from supplied water quality, frequency of usage and volume of water consumption. Early cloggage of filters or frequent filters replacement may resulted by lower quality of supplied water. Always observe the velocity of water flow to determine the need for filters replacement.

* The mahince is only for residential use, the flow rate and life time of filter will depend on actual consumption of water. This machine is not intended to be used for high traffic or commerical purposes.

* Below stated life time of filters is based on municipal water supply condition and average water consumption for residential purposes. The actual life time of filters may vary.

Filter name	Qty	Function	Recommended filter lifespan	Instructions
Composite filter	1	Effectively remove suspended matter, rust, sediment, colloid and other solid substances, humus, residual chlorine, disinfection by-products, organic matter, odor, color and other substances. Effectively alleviate the crystallization of calcium and magnesium ions in the filtration system.	12 to 18 months	Filter lifespan depend on feed water quality.
RO Side Stream	1	Effective interception of heavy metal ions, bacteria, viruses, pesticide residues and other harmful substances.	36 months	
PAC filter	1	Removes odor and adjusts taste.	12 to 18 months	

Replacement method of filter element



Pressure relief, remove the old filter element

1	Close the inlet ball valve, turn on the faucet to relieve pressure, and turn off the power, remove the main engine from the cabinet, and take out the old filter element (left rotation).
2	Install the new filter element according to "installation of filter element and reverse osmosis membrane" in the installation method.

Install new filter element

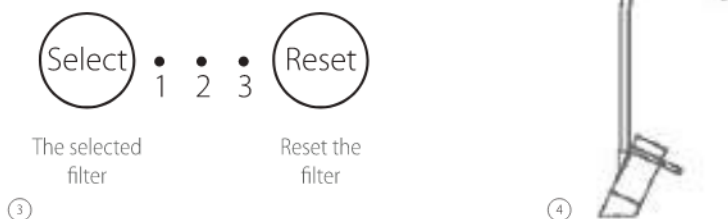

3	Reset the new filter element	On, press the "select" button to select the new filter Core indicator, long press "reset key" for 3 seconds, after successful reset, corresponding filter lamp display Green.
4	Flush	Open inlet ball valve and faucet to flush new filter element.

⚠ Note: the replacement of the waste filter element cannot be cleaned and recycled. It is suggested that you discard the waste filter element as solid household waste and have it buried by professionals.

Troubleshooting

Problem	Possible Cause	Solution
No water flow	<ul style="list-style-type: none"> - Power off. - The integrated valve is out of order and cannot be powered on. - Low inlet pressure/no water supply. - Power supply broken down/no output voltage in computer box. 	<ul style="list-style-type: none"> - Check the power supply or power plug. - After connecting the raw water, measure its resistance and replace it. - Check raw water pressure. - Measure its output voltage and replace it.
High pressure pump works normally but no water is produced	<ul style="list-style-type: none"> - High pressure pump loss of pressure. - Integrated valve cannot feed water (pure water and concentrated water are absent). - The composite filter element is clogged. - The reverse osmosis membrane is clogged. - Slow or no pure water. 	<ul style="list-style-type: none"> - Pressure is around 80psi~100psi, if the pressure is too low, need to replace the pump. - Replace integrated valve. - To check flow rate, the standard flowrate is 1.5L/M - Replace reverse osmosis membrane. - If do not have input voltage for the valve, then replace the main board. the valve work voltage is 36VDC.
The machine stop work but the concentration water won't stop	<ul style="list-style-type: none"> - Integrated valve failed, unable to effectively cut off water. 	<ul style="list-style-type: none"> - Check waste water, if waste water continue flow out after shut off faucet, it should be integrate valve issue.
Slow or no pure water	<ul style="list-style-type: none"> - The filter element/reverse osmosis membrane is blocked. - Integrated valve failure. - Insufficient pressure of high pressure pump. 	<ul style="list-style-type: none"> - Replace the filter element/reverse osmosis membrane. - Replace integrated valve. - Add a pressure gage in the pump outlet, it is easy for serviceman to do that.
Faucet not displayed	<ul style="list-style-type: none"> - The faucet cable is not connected. - Faucet display screen failure. 	<ul style="list-style-type: none"> - Connect the faucet cable to the machine and computer box. - Replace the faucet.

Warranty

Warranty conditions	<p>Users should follow the following rules, or lose warranty rights:</p> <ul style="list-style-type: none">* The machine must be purchased from authorized dealer. The serial number on the warranty card must same as the serial number on machine.* This machine is not a DIY product, installation must be carried out by authorized competent person.* Non-genuine filters, parts, accessories are installed or used.
Exception condition	<p>The limited liability warranty does not cover the failure or damage under circumstances listed below:</p> <ul style="list-style-type: none">* Obtain the product by illegal means (for example, someone steal the product from factory or consumer, and use it directly).* Lost of warranty card or proof of purchase.* Product damage resulting from act of God, human negligence, improper installation or abnormal usage.* Dailure or damage caused by force use of this product beyond normal use conditions. Artificial (intentional or unintentional) mechanical injury. Damage to the machine caused by force majeure (e.g. Natural disasters, wars, etc.)
Procedures	<ul style="list-style-type: none">* Under no circumstances the warranty shall coverage extend to any loss or damage to a person or property for any loss of profit, incidental, contingent, special or consequential damages or any direct or indirect loss.* In case of any disputes, A. O. Smith Corporation reserve the right to make the final decision.

Packing list

PE pipe	1
Water pipe	3 ~ 5 m
Faucet	1
Accessories package	1 package
Filter element and reverse osmosis membrane	1 set
Warranty card, instruction manual	One for each