

gorenje

EN

GB

IE

INSTRUCTIONS FOR USE
BUILT-IN OVEN

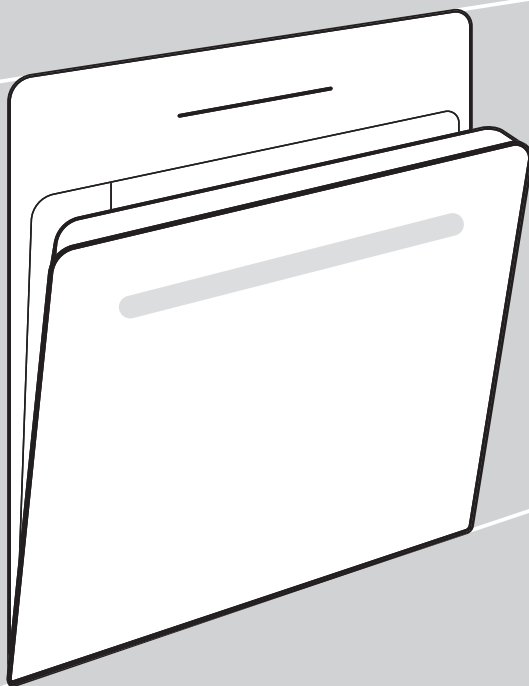

We thank you for your trust and the purchase of our appliance.

This detailed instruction manual is supplied to make the use of this product easier. The instructions should allow you to learn about your new appliance as quickly as possible.

Make sure you have received an undamaged appliance. If you do find transport damage, please contact the seller from which you purchased the appliance, or the regional warehouse from which it was supplied. The telephone number can be found on the invoice or on the delivery note.

Instructions for installation and connection are supplied on a separate sheet.

Carefully read the instructions for use before connecting the appliance. Repair or any warranty claim resulting from incorrect connection or use of the appliance shall not be covered by the warranty.



For more detailed instructions and tips, please visit <http://www.gorenje.com> or scan the QR code on the rating plate.

The following symbols are used throughout the manual and they have the following meanings:

 **INFORMATION!**
Information, advice, tip, or recommendation

 **WARNING!**
Warning – general danger

Contents

1. Safety precautions	4
1.1 Safe and correct use of the oven during pyrolytic cleaning	5
2. Other important safety warnings	5
3. Appliance description	8
3.1 Appliance equipment	8
3.2 Control panel	10
4. Before first use	11
4.1 Switching on for the first time	11
5. Using the oven – selecting the baking settings	13
5.1 Main menu - Manual	14
5.2 Timer - Timer functions	16
5.3 Cooking by steps (+ menu)	18
5.4 Automatic menu	19
5.5 Extra	19
6. Starting the cooking process	21
7. End of cooking by touching	21
7.1 Gratin (+ menu)	22
7.2 Crispy bottom	23
7.3 Favourites - save your own settings	24
8. General settings	25
8.1 Display lock (+ menu)	26
9. ConnectLife	26
10. Wi-Fi management	27
10.1 Using Wi-Fi	27
10.2 Managing the oven remote control	28
11. General tips and advice for baking	30
11.1 Cooking table	31
11.2 Cooking with a Temperature Probe	36
12. Cleaning and maintenance	39
12.1 Automatic oven cleaning – pyrolysis	39
12.2 Removing wire and fixed pull-out (extendible) guides	41
12.3 Removing and replacing the oven door and glass panes	42
12.4 Replacing the bulb	43
13. Troubleshooting	44
13.1 Troubleshooting table	44
13.2 Label – appliance information	45
14. Compliance information	45
15. Environment protection	46
16. Cooking test	47

1. Safety precautions

IMPORTANT SAFETY PRECAUTIONS – CAREFULLY READ THE INSTRUCTIONS AND SAVE THEM FOR FUTURE REFERENCE.

The appliance may only be connected to the power mains by an authorized service technician or expert. Tampering with the appliance or nonprofessional repair thereof may result in risk of severe injury or damage to the product.

Appliance must be connected to fixed wiring which has incorporated means of disconnection. Fixed wiring must be made in accordance with the wiring rules.

For stationary appliances permanently connected to the fixed wiring, compliance with this requirement is deemed to be met if the disconnection instruction incorporated into the fixed wiring complies with AS/NZS 3000 (Australia only).

The appliance must not be installed behind a decorative door in order to avoid overheating.

WARNING: A damaged power cord should only be replaced by the manufacturer or by an authorised repairer or other qualified person, otherwise it may be dangerous.

This appliance can be used by children aged 8 years and above, and by persons with reduced physical, sensory or mental capabilities or lack of experience and knowledge, if they have been given supervision or instruction concerning the use of the appliance in a safe way, and if they understand the hazards involved. Children shall not play with the appliance. Cleaning and user maintenance shall not be done by children without supervision.

WARNING: The appliance and its accessible parts become hot during use; avoid contact with heating elements. Children under 8 years of age must be kept away unless continuously supervised.

The appliance is not intended to be controlled by external timers or separate remote control system.

Only use the food probe recommended for use in this oven.

Do not use harsh abrasive cleaners or sharp metal scrapers to clean the oven door glass/ the glass of hinged lids of the hob (as appropriate), since they can scratch the surface, which may result in shattering of the glass.

Do not use steam cleaners or high-pressure cleaners to clean the appliance as this may result in an electric shock.

Never pour water directly on the bottom of the oven cavity. Temperature differences could result in damage to the enamel coating.

1.1 Safe and correct use of the oven during pyrolytic cleaning

During the automatic cleaning process, the oven heats up to a very high temperature and it is very hot on the outside as well. Risk of burns! Keep children away from the oven.

2. Other important safety warnings

The appliance is intended for household use. Do not use it for any other purpose, such as room heating, drying of pets or other animals, paper, fabrics, herbs etc. As this may lead to injury or fire hazard.

The appliance may only be connected to the power mains by an authorized service technician or expert. Tampering with the appliance or nonprofessional repair thereof may result in risk of severe injury or damage to the product.

We recommend that (due to appliance weight) at least two persons carry and install the appliance.

Do not lift the appliance by holding it by the door handle.

Oven door hinges may be damaged when under excessive load. Do not stand or sit on the open oven door, and do not lean against it. Also, do not place any heavy objects onto the oven door.

If the power cords of other appliances located in the vicinity of the oven become entangled in the oven door, they may get damaged, which may cause a short circuit. Therefore, make sure that the power cords of other appliances are at a safe distance.

Make sure the vents are never covered or obstructed in any other way.

Do not line the oven walls with aluminium foil and do not place baking trays or other containers on the bottom of the oven. This would reduce air circulation in the oven, obstruct and slow down the baking process and destroy the enamel coating.

We recommend you avoid opening the oven door during baking, as this increases power consumption and condensate accumulation.

At the end of the baking process, and during baking, be careful when opening the oven door, as there is danger of scalding.

To prevent limescale accumulation, leave the oven door open after baking or using the oven, to allow the oven cavity to cool down to room temperature.

Clean the oven when it has completely cooled down.

Eventual mismatches in colour shades between different appliances or components within a single design line may occur due to various factors, such as different angles under which the appliances are observed, different coloured backgrounds, materials, and room illumination.

Do not use the appliance if it is damaged. Unplug the appliance from the power mains and call an authorized service centre.

The oven can be safely used with or without baking pan guides.

Do not store items in the oven, which could cause danger when the oven is switched on.

Before you activate automatic cleaning, carefully read and observe all instructions in the chapter Cleaning and Maintenance, which describes correct and safe use of this function

Do not place anything on the oven bottom during the automatic cleaning process.

Risk of fire! During automatic cleaning, the appliance is heated to very high temperatures, which will incinerate food residues in the appliance. Therefore, remove visible dirt from the inside of the oven and from the utensils before each use. Smoke, irritating fumes and gases may also come from the oven while the cleaning function is active. Therefore, make sure that the room is well-ventilated while you carry out this procedure. Small animals or pets can be very sensitive to any fumes that might come out from the oven. It is recommended to remove them from the room during operation and to ventilate the room well after cleaning.

Do not open the oven door during cleaning.

Make sure no foreign objects enter the opening for locking the door guide, as this could block automatic door locking during the oven cleaning process.

Do not touch any metal surfaces or parts of the appliance during the automatic cleaning process!

In case of a power outage during the automatic cleaning process, the program will be terminated after two minutes and the oven door will remain locked. The door will be unlocked, when the appliance senses that the temperature has dropped to below 150 °C in the centre of the oven cavity.

After the self-cleaning process, the oven cavity and the oven accessories can discolour and lose their sheen. This does not affect their functionality.



WARNING!

Using the oven with the door open and the door switch closed is not permitted.



WARNING!

Carefully read the instructions for use before connecting the appliance. Repair or any warranty claim resulting from incorrect connection or use of the appliance shall not be covered by the warranty.

3. Appliance description



WARNING!

Appliance functions and equipment depend on the model.

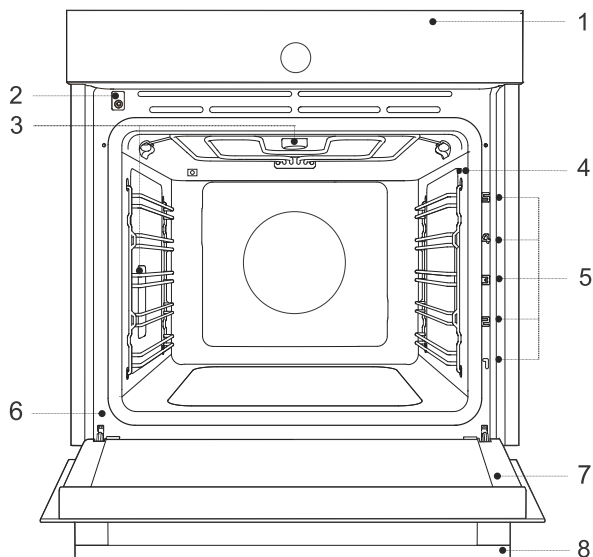

1. User interface
2. Locking the door with a switch
3. Lighting
4. Food probe socket
5. Guides – rack levels
6. Label
7. Oven door
8. Door handle

3.1 Appliance equipment

Oven door switch

The switch switches off the operation of the heaters and the ventilation in the oven room when the oven door is opened during operation.

Guides

Wire guides – always insert the wire rack and baking tray into the guide.

Fixed pull-out guides– place the equipment on the guide. On the same guide, you can place the rack together with the drip pan.

NOTE: Guides – rack levels are counted from the bottom up.

Oven equipment and accessories





Wire rack– used for grilling/broiling or as support for a pan, baking tray or baking dish.

NOTE: When inserting the wire rack into the guide, always make sure its elevated part is at the back and on the top side.

There is a safety latch on the wire rack. Therefore, the wire rack has to be lifted slightly at the front when pulling it out from the oven.

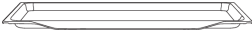
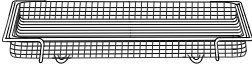
Table continued from last page



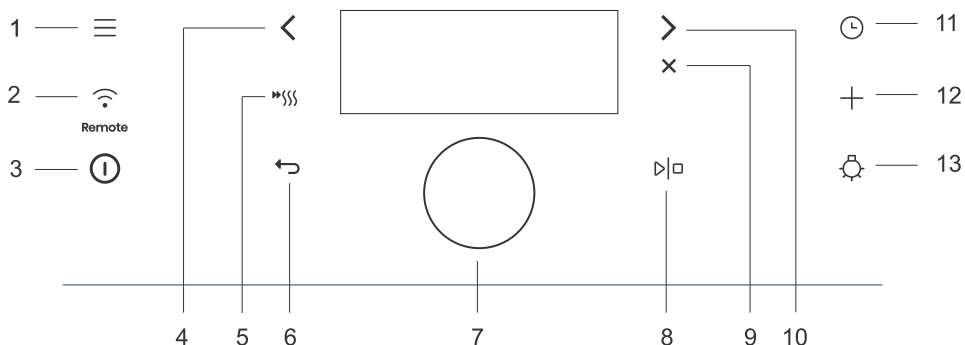

	<p>Drip tray – used for flatbreads and small cakes. It can also be used as a collecting tray. NOTE: A shallow baking tray may become deformed when heated in the oven. When it cools down, it returns to its original state. The deformation does not affect its functionality.</p>
	<p>Airfry grid tray – (baking tray with holes) used for cooking with systems that feature steam injection and for air frying. The holes allow for better air flow around the food and contribute to greater crispness.</p>
	<p>Deep baking tray – used for baking vegetables and moist pastries. It can also be used as a drip tray. NOTE: Never insert the deep all-purpose (or universal) baking tray into the first guide when baking.</p>
	<p>Temperature probe - (BAKESENSOR)</p>
<p>NOTE: Additional equipment can be purchased from an authorised service center.</p>	





3.2 Control panel



Key		Use
1.		Selection of basic menus
2.		Wi-Fi connectivity settings (Remote)
3.		Switching the oven on and off
4.		Left selector key
5.		Switching the fast preheat on and off
6.		Exit the current state without saving
7.		Button for selecting and confirming settings
8.		Starting and stopping the operation
9.		Cancel the current setting, delete the function
10.		Right selector key
11.		Selection of time functions
12.		Advanced settings
13.		Switching the oven light on and off

NOTE: Only the keys that are enabled in the current menu are illuminated (fully or partially) on the control panel.

Explanation of shortcuts in the manual:			
			
Short press – for basic selections	Long press – 5 sec – for additional settings or fast increase of setting	Rotate – to switch between settings.	Press the button – to confirm your selection.
 INFORMATION! The settings are controlled by the keys and the knob. For better key responsiveness, try touching them with as much of your fingertip as possible. Each time you press a key, this will be acknowledged by an audible signal (when this function is available).			

			
First step	Intermediate step	Passed time (exp. oven is operational)	Optional step

4. Before first use

1.	Remove oven utensils and any packaging (cardboard, polystyrene foam, plastic) from the oven.
2.	Wipe the oven accessories and interior with a damp cloth. Do not use abrasive or aggressive cloths or cleaners.
3.	Switch on the oven (see chapter 4.1 <i>Switching on for the first time</i>).
4.	Preheat the oven with the top and bottom heater system for about one hour  at a temperature of 230 °C (see chapter Manual cooking mode).
NOTE: During heating, the characteristic "new smell" is released, so ventilate the room thoroughly during this time.	

4.1 Switching on for the first time

After connecting the appliance to the mains for the first time or after a prolonged power outage, you will need to set the language and time.



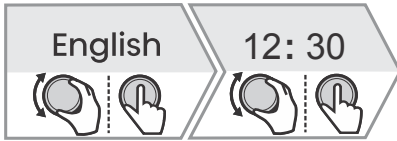

INFORMATION!

If you do not want to set this, press ① . The default settings will be saved. You can change the settings at any time (see chapter8. *General settings*).



1.	Setting the language: The display shows the default language (English). Rotate the KNOB to change the language. Confirm by pressing the KNOB.
2.	Setting the exact time: You can set the exact time of day by rotating the KNOB. Confirm the selection by pressing the KNOB.
3.	Setting the water hardness: Rotate the KNOB to set the water hardness. Confirm the selection by pressing the KNOB.
All initial settings are set and the appliance is in standby mode.	



5. Using the oven – selecting the baking settings

Home menu	
Switch on the appliance  and select  . By rotating the KNOB you can choose from different menus:	
Manual	Allows you to arbitrarily set the cooking parameters with preset values that can be changed (see chapter 5.1 <i>Main menu - Manual</i>).
My modes	Allows a large selection of preset programmes depending on the selected dish (see chapter 5.4 <i>Automatic menu</i>).
Favourites	This mode allows you to select your own programmes that you have previously saved (see chapter 7.3 <i>Favourites - save your own settings</i>).
Extra	Selection of additional programmes (see chapter 5.5 <i>Extra</i>).
Cleaning	Oven cleaning programmes.
Settings	General oven settings (see chapter 8. <i>General settings</i>).

+ menu - additional settings	
The function provides additional setting options. Menu content varies depending on the control options available at that time. To select additional settings, touch  .	
Step bake	Three-step cooking setting with different parameters (see chapter 5.3 <i>Cooking by steps (+ menu)</i>). The function can be selected after setting the cooking time.
Information	Detailed information on the programmes and function of the oven systems.
Gratin	It is used for dishes to which you add dressing/topping or you want to additionally bake its surface at the end. The function can be selected after 10 minutes of cooking or at the end of cooking (see chapter 6. <i>Starting the cooking process</i>).
Favourites	Saving selected custom settings (see chapter 7.3 <i>Favourites - save your own settings</i>).
Display lock	Activating / deactivating the safety key lock to protect the oven from accidental use (see chapter 8.1 <i>Display lock (+ menu)</i>).

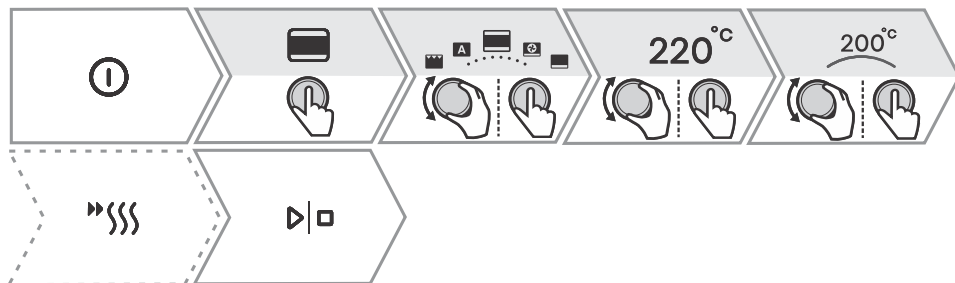
5.1 Main menu - Manual



1.	Switch on the appliance  .
2.	You can select the cooking system by turning the KNOB (see table Selection of cooking systems). Confirm the selection by pressing the KNOB.
3.	Rotate the KNOB to set the temperature to confirm the selection.
4.	Use quick preheating to bring the oven to the desired temperature as quickly as possible. By pressing  the symbol will light up fully. When the set temperature is reached, an acoustic signal sounds. The display will show Insert the dish . Open the door and insert the dish. The programme automatically resumes cooking with the selected settings.
5.	Additionally, you can set: - Timer (see chapter 5.2 <i>Timer - Timer functions</i>) - Cooking by steps (see chapter 5.3 <i>Cooking by steps (+ menu)</i>)
6.	To start cooking, touch  .

Choosing the baking system



















Symbol	Use
	Bottom + Top heater Use this system for conventional cooking on a single rack, making soufflés, and cooking at low temperatures (slow cooking).
	Hot air Hot air allows for better air circulation around the dish. In this way, it dries its surface more and creates a thicker crust. For roasting meat, baking cakes, cooking vegetables and for drying food at one or more levels at the same time.
	Hot air + Bottom heater Perfect for making pizza and pastries with a higher water content. For cooking on one level when you want your dishes cooked and crisp as quickly as possible.
	Bottom + Top heater + Fan For even cooking of dishes on one level and making souffles.
	Large grill For cooking large quantities of flat foods, such as toasted bread, canapees, grill sausages, steaks, fish, skewers, as well as for gratinating and achieving a nice crispy crust. The heaters mounted on the top of the oven cavity heat the entire surface evenly. Low level - suitable for cooking fish fillets, whole fish, frying cheese.

Table continued from last page

Symbol	Use
	<p>Medium level - suitable for cooking small pieces of meat, fish cutlets, vegetables, canapees, skewers.</p> <p>High level - suitable for cooking steaks, burgers, grill sausages, toast and cooking au gratin.</p>
	<p>Large grill + Fan For roasting poultry and grilling large pieces of meat.</p>
	<p>Hot air + Top heater This cooking method gives the food a crispy crust, without added fat. It is a healthy version of "fast food" with a lower calorie content. Suitable for small cuts of meat, fish, vegetables and pre-cooked frozen products (fries, chicken medallions).</p>
	<p>More systems Confirm your selection with OK . Additional systems will be displayed.</p>
	<p>Large grill + Bottom heater For faster cooking of dishes on one level and for a crispy pastry crust.</p>
	<p>Bottom heater + Grill For gentle and controlled slow cooking of delicate food (soft cuts of meat) and baking pastry with a crunchy bottom.</p>
	<p>Bottom heater + Grill + Fan For optimal preparation of yeast-leavened bakery products and all types of bread and for preservation.</p>
	<p>Large grill + Bottom heater + Hot air For dishes where even crispiness from all sides is desirable. The function is also suitable as a first step of multi-step roasting of meat, as it allows for quick searing of the surface in the initial phase and slow roasting in the second phase. The meat will be juicy and the crust nicely browned.</p>
	<p>Hot Air + Grill Hot air allows for better air circulation around the dish. This will dry out the surface more. In combination with the grill heater this will also result in a more intensive colour. For faster cooking of meat and vegetables.</p>
	<p>ECO Hot air¹⁾ For gentle, slow and even cooking of meat, fish and pastries on one level. This way of cooking retains a higher proportion of water in the meat, which leaves it juicier and softer, while the pastry becomes evenly browned/baked. The used temperature range is between 140 °C and 220 °C. It is the most energy-saving program.</p>
	<p>Auto Shortcut to the Auto menu (see chapter Auto menu)</p>

¹⁾ This function is used to determine the energy efficiency class according to EN 60350-1.

5.2 Timer - Timer functions

To select the timer functions, touch  . By pressing  or  you can select the time function you want to set.

The time function can be set before and during cooking.



INFORMATION!

The clock must be set to day time.





INFORMATION!

You can reset the selected time function by touching **0:00** .

Description / time function	Use
Duration	In this mode, you can specify the duration of operation for the oven.
Egg timer	The independent alarm operates independently of the oven operation. After the set time has expired, the appliance does not turn on or off automatically.
End baking at	Use this mode when you want the food in the oven to start cooking with a time delay. Enter the duration and desired end time of cooking. The appliance starts automatically and ends its operation at the desired time.

Setting duration



1. Rotate the KNOB to set the desired cooking time. Confirm the selection by pressing the KNOB. The selected oven operating time will appear on the display unit.
2. To start cooking, touch   .

Setting the timer



1. Rotate the KNOB to set the timer duration. Confirm the selection by pressing the KNOB.
- The maximum possible setting is 24 hours.
NOTE: If the appliance is switched off, the timer is still active.

Setting the End baking at

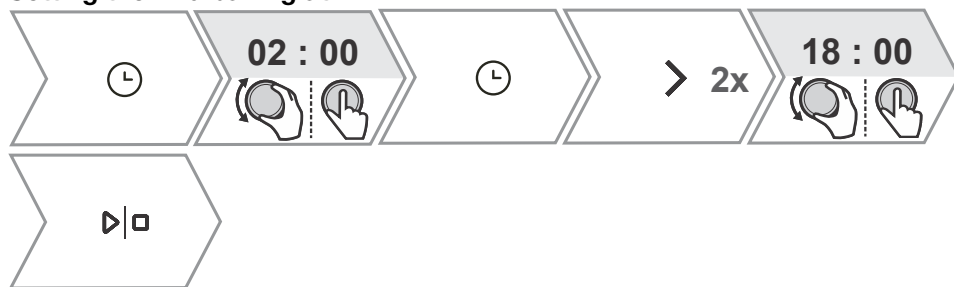

1.	First set the cooking time. Rotate the KNOB to set the desired cooking time. Confirm the selection by pressing the KNOB. The selected oven operating time will appear on the display unit. <i>Example: cooking time is 2 hours</i>
2.	Delayed cooking switch-off is selected by pressing ⌚ and then double-clicking on > . Rotate the KNOB to set the time at which you want the dish to be ready. Confirm the selection by pressing the KNOB. The desired end time is shown on the display. <i>Example: cooking ends at 18:00 ⌚</i>
3.	To start cooking, touch ▶ ◻ . The oven switches to partial standby mode while waiting for switch-on. The selected settings are automatically switched on and off at the selected time. <i>Example: cooking starts at 16:00, cooking ends at 18:00</i>
After the set time has expired, the oven stops working automatically. A short beep will be emitted.	



WARNING!

This function is not suitable for food that requires quick preheating.

Perishable food should not be kept in the oven for a long time. Before using this mode, check whether the clock on the appliance is accurately set.

5.3 Cooking by steps (+ menu)

This function allows you to set the cooking in three steps (combine three consecutive cooking steps in one cooking process).



INFORMATION!

The function can be set in the Main Menu - manual cooking mode (see chapter 5.1 Main menu - Manual).

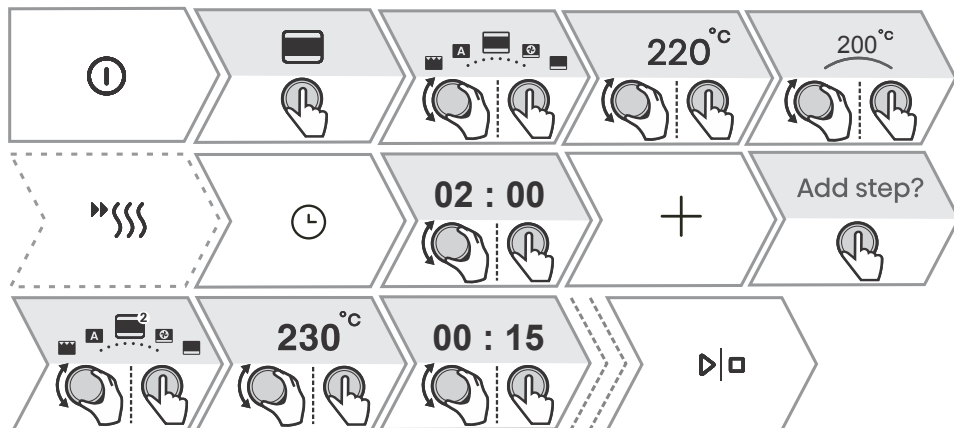

1.	Switch on the appliance .
2.	Step 1 By turning the KNOB, you can select the cooking system, temperature and cooking duration as the first step. Confirm the selection by pressing the KNOB. You can also choose quick preheating.
3.	Select additional settings. Touch . The display will show Add step . Confirm by pressing the KNOB.
4.	Step 2 Select the settings for the second cooking step (see setting under point 2). Confirm the selection by pressing the KNOB. NOTE: Do the same for Step 3 .
5.	You can also change all three steps before starting cooking. By pressing or you can select the step you want to change.
6.	To start cooking, touch . The oven first starts working with the settings for the first step.
NOTE: You can remove an individual step by touching .	

5.4 Automatic menu

The programme offers you a large selection of preset recipes that were approved by chefs and nutritionists.

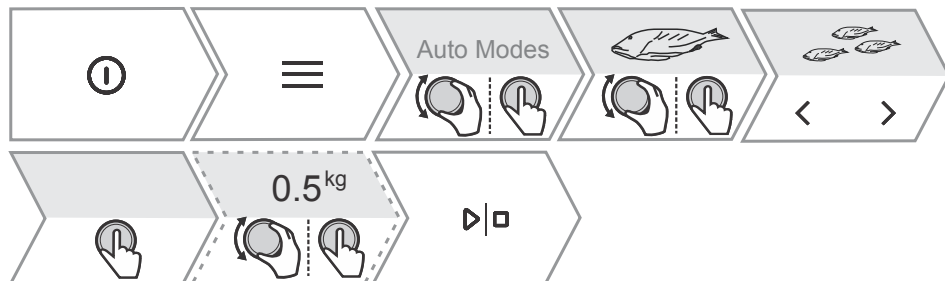

1.	Switch on the appliance and select . Rotate the KNOB to select Auto . Confirm by pressing the KNOB to enter the submenu.
2.	Rotate the KNOB to select the desired category and confirm the selection by pressing the KNOB. By pressing or select a subcategory, then rotate the KNOB to specify the type of dish and confirm the selection by pressing the KNOB again. The recipes have a predetermined system, temperature and cooking time. NOTE: For some dishes, you can change the weight and degree of cooking.
3.	To start cooking, touch .
4.	Some dishes also include the quick preheating function. When the set temperature is reached, an acoustic signal will sound. The display will show Insert the dish . Open the door and insert the dish. The programme automatically resumes cooking with the selected settings.
NOTE: By touching you can see a detailed description of the current selection.	

5.5 Extra

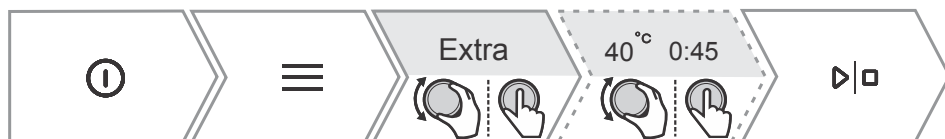

1.	Switch on the appliance and select . By pressing the KNOB, select Extra . By pressing the KNOB again, confirm the selection to enter the submenu.
2.	Rotate the KNOB to select a function (see table below). Confirm by pressing the KNOB. Preset values are displayed. Some functions allow you to set the temperature and cooking duration.
3.	To start cooking, touch .

Programme	Use
Air Fry	Frying food with hot air, without added fat. Faster and healthier version of "fast food". This cooking method gives the food a crispy crust, without added fat. It is a healthy version of "fast food" with a lower calorie content.
Proofing	The dough will rise faster and more evenly without drying out the surface. While the dough is rising, do not open the door.
Dehydrate	With the help of air, you reduce the amount of moisture in the food and thus prolong its durability.
Defrost	Used for the slow defrosting of frozen food (cakes, pastries, bread and fruit). Halfway through defrosting, turn the food over and separate the pieces if they are stuck to each other.
Reheat	This mode allows you to gently reheat ready-made dishes. Do not open the door unnecessarily during operation.
Keep warm	It is used to keep already prepared dishes warm. Do not open the door during operation.
Plate warming	Useful if you want to preheat the plates or cups so that the food stays warm for a long time. You can set the temperature range.
Preserving	The process by which we prolong the durability of the food. Use jars with a rubber sealing ring and lid. Do not use jars with threaded or metal caps or metal tins. Pour 1 litre of hot water (approximately 70 °C) into the deep tray and place 6 identical jars into the tray. Place the baking tray in the oven on the second guide.
Sterilise bottles	Suitable for sterilisation of all types of bottles. Sterilisation is a process that destroys all types of microorganisms.
Sabbath	The Sabbath function allows the food in the oven to stay warm without having to turn the oven on and off. Set the duration of operation (between 24 and 72 hours) and temperature. By pressing $\triangleright \square$, the countdown begins. All sounds and operations are switched off except for the key $\textcircled{1}$. NOTE: In case of a power outage, Sabbath mode will be deactivated and the oven will return to its initial state.

6. Starting the cooking process

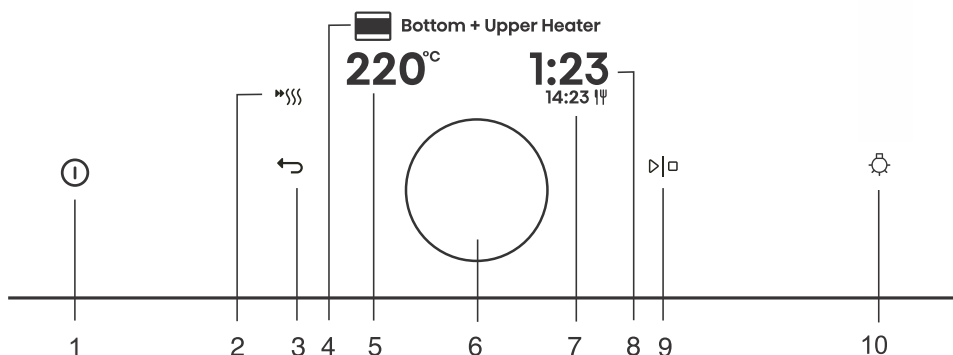

Key	Use
1.	Switching the oven on and off
2.	Switching the fast preheat on and off
3.	Exit the current state without saving
4.	Selected cooking system
5. 220°C	Selecting the temperature
6.	Button for selecting and confirming settings
7. 14:23	End time
8. 1:23	Elapsed cooking time
9.	Starting and stopping the operation
10.	Switching the oven light on and off

NOTE: Only the keys that are enabled in the current menu are illuminated (fully or partially) on the control panel.



INFORMATION!

During the cooking process, you can change the system, temperature and timer functions.

7. End of cooking by touching

After cooking is completed, the display shows **Baking finished**.

You can also stop the operation by touching **Baking finished**.



By turning the KNOB, you can select a new setting. Confirm by pressing the KNOB. Menu content varies depending on the control options available at that time.	
Baking finished	Select End to finish cooking. The main menu appears on the display.
Add extra time	By selecting this, you extend the cooking with the same system and temperature settings. NOTE: If you had a cooking duration set, the time is counted forward from where it was stopped.
Gratin	Select to cook the top of the dish even more (see chapter 7.1 <i>Gratin (+ menu)</i>).
Crispy bottom	Select to further brown the underside of the dish (see chapter 7.2 <i>Crispy bottom</i>).
Add to favorite?	This mode allows you to save the selected settings to your favourites and use them again later (7.3 <i>Favourites - save your own settings</i>).



INFORMATION!

After the operation is completed, all timer settings are also stopped and deleted, except for the egg timer. Time of day (clock) will be displayed. The cooling fan will continue to operate for a while.

After the use of the oven, some water may be left in the condensate channel (underneath the door). Wipe the channel with a sponge or a cloth.

7.1 Gratin (+ menu)

This function is used in the last phase of cooking, when we add dressing/topping to the dish or we want to crisp its surface. When using the gratin function, a crispy golden yellow crust is formed on the dish, which protects it from drying, and at the same time gives the dish a nicer appearance and better taste.



1.	Press + and rotate the KNOB to select Au gratin . The function is available after 10 minutes of operation.
2.	The display shows the preset system (large grill) and the temperature 300 °C. Set the operating time (max 10 min) and confirm the selection by touching ▷ □ .
3.	The function can also be switched off during operation. Switch off the cooking by touching ▷ □ .

Table continued from last page



WARNING!

Control the cooking. When using the au gratin function, the oven reaches high temperatures.

The au gratin function works for a maximum of 10 minutes, then the oven switches off automatically.

7.2 Crispy bottom

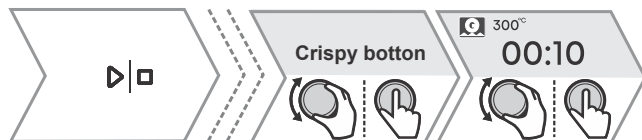







This function is available only at the end of cooking and can be activated for 10 min.

- | | |
|----|--|
| 1. | In the final menu, rotate the KNOB to select Crispy botton . Confirm your selection by touching ▷ ◻ . |
| 2. | Switch off the cooking by touching ▷ ◻ . |

7.3 Favourites - save your own settings

Add to favourites is a feature that allows you to save your favourite and most frequently used settings and use them again in the future. Up to 12 recipes can be stored.



1.	<p>Saving recipes in settings. Press  and rotate the KNOB to select Add to favorite?. Confirm by pressing the KNOB.</p>
2.	<p>Saving the setting after cooking is completed. In the final menu, rotate the KNOB to select Add to favorite?. Confirm by pressing the KNOB.</p>
<p>You can also change the name of a saved setting. Rotate the KNOB to select the letter and confirm it by pressing the KNOB. If necessary, delete the character with . Confirm with  to save your favourite recipe.</p>	
3.	<p>Displaying already saved recipes. Press . Rotate the KNOB to select My modes. Confirm by pressing the KNOB to enter the submenu. Saved recipes are displayed. NOTE: You can also change the preset values for already saved recipes and save them under a new name after cooking.</p>
4.	<p>Deleting already saved recipes Switch on the appliance and select . Rotate the KNOB to select My modes. Confirm by pressing the KNOB to display already saved recipes. Select a recipe and delete it by pressing .</p>

8. General settings



WARNING!

After a power outage or after the appliance is switched off, additional function settings will remain stored for no more than a few minutes. Then, all settings, except for the acoustic signal volume and display dimmer will be reset to factory defaults.







<p>Press . Rotate the KNOB to select Settings. Confirm by pressing the KNOB to enter the submenu. Rotate the KNOB to edit the individual settings. Confirm the selection by pressing the KNOB.</p>	
1.	 <p>Clock Set the hours and minutes. You can select the 12h or 24h display by touching .</p>
2.	 <p>Volume You can choose between four levels of volume (no sound, low, medium, high).</p>
3.	 <p>Touch Sound Enable or disable key sound.</p>
4.	 <p>Night mode This feature automatically reduces display brightness between 19:00 and 7:00 and turns off the clock display as well as the acoustic signals. To activate night mode, specify the start time and end time of operation. Turn off the night mode by pressing .</p>
5.	 <p>Display The function allows you to turn the daytime display on or off. It is deactivated by default (OFF). If the function is turned on (ON), electricity consumption may increase.</p>
6.	 <p>Fast preheat settings The function activates automatic preheating to cooking systems that allow it. Turn it on (ON) or off (OFF).</p>
7.	 <p>Heating systems The function activates the display of all cooking systems on the display unit. Turn it on (ON) or off (OFF).</p>

Table continued from last page

8.		Resets - Factory reset This function resets the appliance to factory settings. The display will show Reset , which is confirmed by long pressing ▷ □ .
9.		Language The display shows the default language (English). If the language in which the texts are displayed on the display does not suit you, choose another one.
To exit the general settings menu, touch ≡ or ↶		

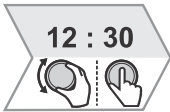
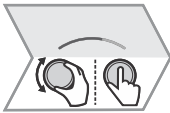
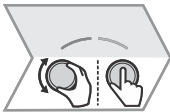
8.1 Display lock (+ menu)

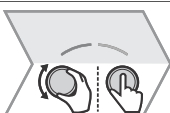
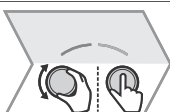
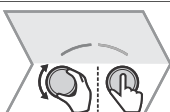

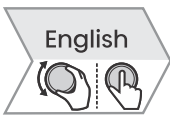
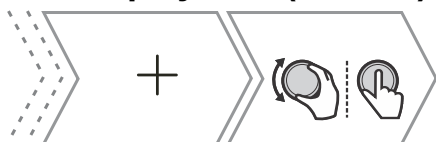
1. Press + and rotate the KNOB to select **Display locked**. Confirm the selection by pressing the KNOB. The screen is now locked.
To unlock the screen, touch + .

- If the lock is activated with no timer function engaged (only clock is displayed), then the oven will not operate.
- If the lock is activated after a timer function has been set, then the oven will operate normally; however, it will not be possible to change the settings.
- When the keys are locked, you cannot change the cooking systems or additional functions. You can only turn off the cooking.
- The keys remain locked even after the oven is switched off. To select a new system, you must deactivate the lock.

9. ConnectLife

Connecting the appliance to the ConnectLife application

ConnectLife is a smart home platform that connects people, devices and services. The **ConnectLife** application includes advanced digital services and carefree solutions that allow users to monitor and control appliances, receive notifications from a smartphone, and update software (supported features may vary depending on your appliance and the region/country in which you are located).

To connect your smart device, you need a home Wi-Fi network (only 2.4 GHz networks are supported) and a smartphone equipped with the application **ConnectLife**.



To download the **ConnectLife**, application, scan the QR code or search for **ConnectLife** in your favourite app store.

1. Install the **ConnectLife** application and create an account.
2. In the **ConnectLife** application, go to the "Add device" menu and select the appropriate type of device. Then scan the QR code (it can be found on the nameplate of the appliance; you can also enter the AUID/MV number manually).
3. The application then guides you through the entire process of connecting the appliance to your smartphone.
4. After a successful connection, the appliance can be operated remotely via the mobile application.

10. Wi-Fi management

INFORMATION!



If this setting is not available, then your oven is not fitted with a Wi-Fi module and does not support internet connectivity.

When the Wi-Fi module is enabled and connections are successfully set up and synchronized, then the oven can be controlled and operated via a mobile device and the **ConnectLife** app.



The Wi-Fi connection works in the same frequency range as some other devices (e.g. microwave ovens and remote-controlled toys). Consequently, temporary or permanent disruption of the connection is possible. In such cases, the availability of the offered functions cannot be guaranteed.

Ensuring the quality of the functions offered depends heavily on the signal strength. If the router is far away from the appliance, there may be problems with the reliability of the connection.

10.1 Using Wi-Fi

Switch on the appliance , then press  to activate the Wi-Fi function settings.

To enter different Wi-Fi module settings, press .

If you touched  inadvertently, the setting can be cancelled by repeatedly long tapping (for 18 seconds) .









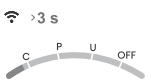

1.		<p>Switching on the Wi-Fi module: After long-pressing (up to 3 seconds) , the display will show Wifi On to indicate that the module is switched on. The symbol Wifi On will start blinking.</p>
2.		<p>Connecting the appliance: After long-pressing (between 3 to 6 seconds) , the display will show Connection setup. NOTE: For further settings, follow the instructions in the ConnectLife app..</p>

Table continued from last page

3.		<p>Connecting additional users: After long-pressing (between 6 to 9 seconds) , the display will show Pairing. Use this setting to connect additional users to the appliance using the ConnectLife app.. NOTE: For further settings, follow the instructions in the ConnectLife app..</p>
4.		<p>Removing all connected users: After long-pressing (between 9 and 12 seconds) , the display will show Unpair all. Use this setting to remove all connected users from the ConnectLife app..</p>
5.		<p>Switching off the Wi-Fi module: Switch off the Wi-Fi connection by long tapping (between 15 and 18 seconds) . The display will show Wifi Off.</p>

10.2 Managing the oven remote control

WARNING!

The remote monitoring function via a mobile device should not be used to replace direct personal supervision of the cooking process in the oven. Always regularly check, in person, what is actually going on in the oven.

Press . The display shows **Remote** to indicate the possibility of remote control via the ConnectLife app.,

INFORMATION!

For safety reasons, some functions are not available via remote access.

- If the oven is in standby mode and you open the oven door, the remote control option has to be enabled again.
- If oven door is opened during the baking process, the remote control option on the oven is disabled.
- Any user activity on the control unit will automatically disable the remote control option on the oven.
- Cancellation or completion of the baking program or process is the only option that remains available regardless of whether remote control is enabled or not.
- Remote control is disabled when using a microwave system (not applicable to combined microwave systems).
-

WARNING!

Always make sure the oven is used correctly and in compliance with the instructions, especially when using remote control. Do not run the oven via remote access unless you are certain about what exactly is in the oven.

Wi-Fi status	Wi-Fi symbol on the display unit
Wi-Fi is disabled.	Wi-Fi is constantly dimly lit.
Wi-Fi is enabled and it is successfully connected to the server.	The Wi-Fi symbol is constantly fully lit.

Table continued from last page

Wi-Fi status	Wi-Fi symbol on the display unit
Wi-Fi is enabled and: <ul style="list-style-type: none">• a connection to the server is being established,• is in the state of setting up or establishing connections,• there is no connection to the server.	Wi-Fi icon is fully lit and flashes.
Remote control of the oven is not enabled.	REMOTE symbol is not lit on the display unit.
Remote control of the oven is enabled.	REMOTE sign is fully lit on the display unit.

11. General tips and advice for baking

Equipment:

- Use equipment made of heat-resistant non-reflective materials (supplied baking trays and dishes, enamel-coated cookware, tempered glass cookware). Bright-coloured materials (stainless steel or aluminium) materials reflect heat. As a result, thermal processing of food in them is less effective.
- Always insert the baking sheets and trays to the end of the guides. When baking on the wire rack, place the baking dishes or trays in the middle of the rack.
- Do not place the baking trays directly onto the oven cavity bottom.
- Do not use the all-purpose deep baking tray on the 1st guide level while the appliance is operating.
- Do not cover the oven cavity bottom or the wire rack with aluminium foil.
- Always place the baking dishes onto the wire rack.
- When cooking on several levels at the same time, insert the deep all-purpose baking tray into the lower level.
- If you are using parchment paper, make sure it is resistant to high-temperatures. Always trim it accordingly. Parchment paper prevents the food from sticking to the baking tray and makes it easier to remove the food from the baking tray.
- When baking directly on the wire rack, insert the all-purpose deep tray one level lower to serve as a drip tray.

Food preparation:

- For optimum food preparation, we recommend observing the guidelines specified in the cooking table. Choose the lower specified temperature and the shortest specified cooking time. When this time expires, check the results and then adjust the settings as necessary.
- When cooking according to recipes from older cookbooks, use the bottom and top heater system (as in conventional ovens) and set the temperature 10 °C lower than specified in the recipe.
- When cooking larger cuts of meat or pastry with higher water content, a lot of steam will be generated inside the oven, which in turn may condense on the oven door. This is a normal phenomenon which will not affect the operation of the appliance. After the cooking process, wipe the door and the door glass dry.

Efficient use of energy

- Preheat the oven only if indicated in the recipe or in the tables in this instruction manual. If you are using quick preheating, do not put food in the oven until the oven is fully heated, unless otherwise recommended. When heating an empty oven, a lot of energy is consumed, so if possible, we recommend that you prepare several dishes in a row or several dishes at the same time.
- Remove all unnecessary equipment from the oven during baking
- Unless it is absolutely necessary, do not open the oven door during baking.
- With longer cooking programs, you can switch off the oven approximately 10 minutes before the end of cooking time to make use of the accumulated heat.

11.1 Cooking table

NOTE: Dishes requiring a fully pre-heated oven are indicated with a single asterisk in the table. *
Dishes that only require a 5-minute preheating of the oven are indicated with two asterisks. **. In
this case, do not use the quick preheating mode.























Dish			 °C	 min
PASTRY AND BAKERY PRODUCTS				
pastry/cakes in moulds				
sponge cake	3		170	30-40
pie with filling	2		160	70-120
marble cake	2		170-180	50-60
cake with leavened dough, Gugelhupf (Bundt cake, pound cake)	2		170-180	45-55
open pie, tart	3		170-180	35-45
brownies	2		170-180	30-35
pastry on baking trays and dishes				
strudel	2		180-190	60-70
strudel, frozen	2		200-210	34-45
sponge roll	3		170-180 *	13-18
buchteln	2		180-190	30-40
biscuits, cookies				
cupcakes	3		160 *	25-35
cupcakes, 2 levels	1, 5		140-150 **	30-40
yeast-leavened small pastry	2		180 *	17-22
yeast-leavened small pastry, 2 levels	2, 4		160 *	18-25
puff pastry	3		200-220	30-45
puff pastry, 2 levels	2, 4		170 *	25-30
cookies/biscuits				
piped cookies	3		150	30-40
piped cookies, 2 levels	2, 4		150 *	30-40

Table continued from last page



























Dish			 °C	 min
piped cookies, 3 levels	1, 3, 5		145 *	40-50
cookies/biscuits	3		160-180	40-50
biscuits, 2 levels	2, 4		150-160 *	20-25
meringue	3		80-100 *	120-150
meringue, 2 levels	2, 4		80-100 *	120-150
macarons	3		130-140 *	15-20
macarons, 2 levels	2, 4		130-140 *	15-20
bread				
rising and proofing	2		40-45	30-45
bread on a baking tray	2		190-200	40-55
bread on a baking tray, 2 levels	2, 4		190-200 *	40-55
bread in a tin	3		190-200	30-45
bread in a tin, 2 levels	2, 4		200-210	30-45
flatbread (focaccia)	2		270	15-25
fresh bread rolls (Semmel/morning rolls)	3		180-200	20-30
fresh bread rolls (Semmel/morning rolls), 2 levels	2, 4		200-210 *	15-20
toast	5		High	4-6
open sandwiches	5		Medium	5-9
pizza and other dishes				
homemade pizza	1		300 *	4-10
pizza, two levels	2, 4		210-220 *	25-30
frozen pizza	2		200-220	10-20
frozen pizza, two levels	2, 4		200-220	10-25
savoury pie, quiche	2		190-200	50-60

Table continued from last page

























Dish			 °C	 min
burek	2		190-210	40-50
MEAT				
beef and veal				
beef roast (loin, rump), 1.5 kg	2		160-170	130-160
braised beef, 1.5 kg	2		200-210	90-120
sirloin, medium done, 1 kg	2		170-190 *	40-60
beef roast, slow cooked	2		120-140 *	250-300
beef steaks, well done, thickness 4 cm	4		High	25-30
burgers, thickness 3 cm	4		High	25-35
veal roast, 1.5 kg	2		160-170	120-150
pork				
pork roast, rump, 1.5 kg	3		200-220	100-200
pork roast, shoulder, 1.5 kg	3		180-190	90-120
pork loin, 400 g	2		80-100 *	80-100
pork roast, slow cooked	2		100-120 *	200-230
pork ribs, slow cooked	2		120-140 *	210-240
pork chops, thickness 3 cm	4		Medium	20-25
poultry				
poultry, 1.2–2.0 kg	2		200-220	60-80
poultry with stuffing, 1.5 kg	2		170-180	70-90
poultry, breast	2		170-180	45-60
chicken thighs	3		210-220	25-40
chicken wings	4		210-220	25-40
poultry, breast, slow cooked	3		100-120 *	60-90
meat dishes				

Table continued from last page







































Dish			°C	min
meat loaf, 1 kg	2		170-180	60-70
grill sausages, bratwurst	4		High	8-15
FISH AND SEAFOOD				
whole fish, 350 g	4		230-240	12-20
fish fillet, thickness 1 cm	4		Low	8-12
fish steak, thickness 2cm	4		Medium	10-15
scallops	4		230 *	5-10
shrimps	4		Low	3-10
VEGETABLES				
baked potatoes, wedges	3		180-200 *	30-40
baked potatoes, halved	3		200-210 *	40-50
stuffed potato (jacket potato)	3		190-200	30-40
French fries, home-made	4		210-220 *	20-30
mixed vegetables, wedges	3		190-200	30-40
stuffed vegetables	3		190-200	30-40
CONVENTIONAL PRODUCTS – FROZEN				
French fries	3		210-220	20-25
french fries, 2 levels	2, 4		190-210	30-40
chicken medallions	4		210-220 *	12-17
fish fingers	2		210-220	15-20
lasagne, 400 g	2		200-210	30-40
diced vegetables	2		190-200	20-30
croissants	3		170-180	18-23
BAKED PUDDINGS, SOUFFLÉS AND DISHES AU GRATIN				
potato moussaka	2		180-190	35-45

Table continued from last page

Dish			 °C	 min
lasagne	2		180-190	35-45
sweet baked pudding	2		160-180	40-60
sweet soufflé	2		160-180 *	35-45
dishes au gratin	3		170-190	30-45
stuffed tortillas, enchiladas	2		180-200	20-35
grilling cheese	4		Low**	10-12
OTHER				
preservation	2		180	30
sterilization	3		125	30
cooking in a bain-marie (double boiler)	2		150-170 *	/
reheating	3		60-95	/
plate warming	2		75	15

11.2 Cooking with a Temperature Probe (BAKESENSOR)

The food probe allows for accurate monitoring of the core temperature of the food during cooking.



WARNING!

The food probe should not be in direct vicinity of the heating elements.

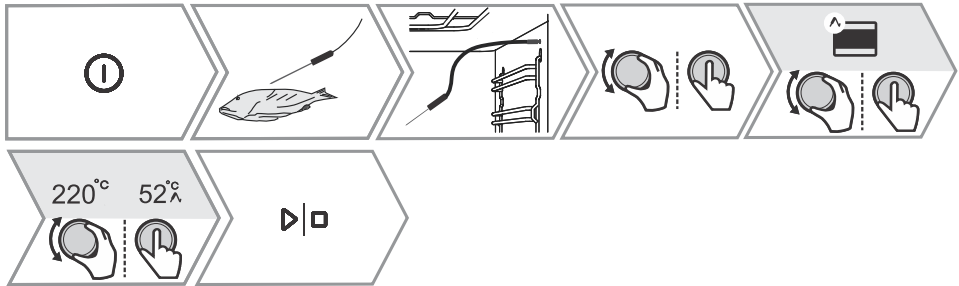

1.	Stick the metal end of the probe into the thickest part of the food. NOTE: To start cooking with the temperature probe, the current cooking process must first be interrupted and then the temperature probe must be connected to the socket. By inserting the probe into the socket, the preset functions on the oven are deleted.
2.	Insert the probe plug into the socket. Rotate the KNOB to select auto or manual setting. Confirm the selection by pressing the KNOB.
3.	- In manual mode, the symbol \wedge will appear next to the system on the display unit, together with the preset cooking temperature (in the temperature range up to 210 °C), which can be changed. Also determine the core temperature of the food (in the temperature range from 30 to 99 °C). The use of manual mode is shown in the picture above. - In auto mode rotate the KNOB to select the dish. The recipes have a predetermined system, temperature and cooking time. You can change the degree of browning NOTE: When using the probe, setting the cooking time is not possible.
4.	Confirm the setting by touching $\triangleright \square$. During cooking, the set temperature and current temperature of the foodstuff are alternated on the display. If desired, you can change the cooking temperature or the desired core temperature of the foodstuff during operation.
5.	When the set core temperature is reached, the oven will stop operating. The display will show Baking finished . An acoustic signal will be heard which you may turn off with any key. After one minute, the acoustic signal will be switched off automatically.



INFORMATION!

The use of a temperature probe enables automatic cooking selection mode.

Correct use of the probe, by type of food:

- poultry: stick the probe in the thickest part of the breast;
- red meat: stick the probe into a lean part that is not marbled with fat;
- smaller chunks with bone: stick them into an area along the bone;
- fish: stick the probe behind the head, towards the spine.

**WARNING!**

After use, carefully remove the probe from the food and socket, clean it, and tighten the socket cover.

Recommended doneness levels for different types of meat























Type of food	 / °C / 	medium rare [°C]	medium [°C]	medium well [°C]	well done [°C]
BEEF					
beef, roast	 / 170 / 2	48-52	53-58	59-65	68-73
beef, sirloin	 / 140 / 2	49-53	54-57	58-62	63-66
roast beef/rump steak	 / 160 / 3	49-53	54-57	58-62	63-66
burgers	 / High / 4	54-57	60-63	66-68	71-74
VEAL					
veal, sirloin	 / 140 / 2	49-53	54-57	58-62	63-66
veal, rump	 / 160 / 2	49-53	54-57	58-62	63-66
PORK					
roast, neck	 / 170 / 3	/	/	65-70	75-85
pork, loin	 / 140 / 2	/	/	60-69	/
meat loaf	 / 170 / 2	/	/	/	80-85
LAMB					
lamb	 / 170 / 3	60-65	66-71	72-76	77-80
MUTTON					
mutton	 / 170 / 3	60-65	66-71	72-76	77-80
GOAT MEAT					
goat	 / 170 / 3	60-65	66-71	72-76	77-80
POULTRY					
poultry, whole	 / 210 / 2	/	/	/	82-90
poultry, breast	 / 170 / 2	/	/	/	62-65
FISH AND SEAFOOD					
trout	 / 210 / 4	/	/	62-65	/

Table continued from last page

Type of food	 /  °C / 	medium rare [°C]	medium [°C]	medium well [°C]	well done [°C]
tuna	 / Medium / 4	/	/	55-60	/
salmon	 / Medium / 4	/	/	52-55	/

12. Cleaning and maintenance



WARNING!

Before manual cleaning, unplug the appliance from the power mains and wait for it to cool down.

Children should not clean the appliance or perform maintenance tasks without proper supervision.

- For easier cleaning, oven cavity and baking tray are coated with special enamel for a smooth and resistant surface.
- Regularly clean the appliance and use warm water and hand dishwashing liquid to remove larger impurities and limescale. Use a clean soft cloth or sponge cloth.
- Never use aggressive or abrasive cleaners and accessories (abrasive sponges and detergents, stain and rust removers, scrapers for glass ceramic plates).
- Food residue (fat, sugar, protein) can ignite during the use of the appliance. Therefore, remove larger chunks of dirt from the oven interior and accessories before each use.
- Oven equipment is dishwasher-safe. Pull-out guides are not suitable for this type of cleaning.

Exterior of the appliance	Use hot soapy water and a soft cloth to remove impurities and wipe the surfaces dry.
Interior of the appliance	For stubborn dirt or grime, use conventional oven cleaners. After using such agents, wipe the appliance thoroughly with a wet cloth to remove any residual cleaning agents.
Utensils and guides	Clean with hot soapy water and a damp cloth. In case of persistent dirt, we recommend prior soaking and the use of a brush.
If the cleaning results are not satisfactory, repeat the cleaning process.	



WARNING!

Do not use corrosive, abrasive, or aggressive cleaning agents when cleaning the oven's front panel. Such agents may damage the surface, cause scratches, or permanently alter its appearance.

12.1 Automatic oven cleaning – pyrolysis



WARNING!

Before manual cleaning, unplug the appliance from the power mains and wait for it to cool down.

Children should not clean the appliance or perform maintenance tasks without proper supervision.

Thanks to the high temperatures, the function allows for the easy cleaning of the interior of the appliance and some of the supplied equipment (deep universal baking tray, shallow baking tray and guides). During cleaning, fat residues and other impurities are incinerated and cremated.

There are three pyrolysis (cleaning intensity) levels available, with varying duration of the process:

Level	Cleaning purpose	Program duration
Low	For minor impurities	2 h
Medium	For noticeable major impurities	2 h 15 min

Table continued from last page

Level	Cleaning purpose	Program duration
High	For stubborn and persistent (older) impurities	2hrs 30mins
NOTE: The more stubborn the dirt, the higher the level that should be selected.		

Preparing for pyrolytic cleaning

Based on an average oven usage rate, we recommend pyrolytic cleaning once a month.

- Remove the Airfry grid tray and the food probe from the oven.
- Remove all visible dirt and food residue from the oven.
- Only start pyrolytic cleaning when the appliance is cooled.
- It is possible to clean the supplied equipment: the deep universal baking tray, shallow baking tray and guides.
- Insert the accessories into the groove on the second or third guide level – never use the first guide level.
- After the pyrolytic cleaning, wait for the equipment to cool down and clean it with hot soapsuds and a damp cloth.
- When cleaning the pull-out guides, pull them out and remove after the procedure has been completed.

INFORMATION!

For better cleaning results, we recommend cleaning the oven and the accessories/equipment separately. When using the pyrolytic cleaning process to clean the equipment, the oven cavity may not be completely clean at the end of the cycle.

If you are not happy with the cleaning results, we recommend repeating the process.

As a result of automatic pyrolytic cleaning, the interior of the oven and the accessories can change the color and lose the shine. The pull-out guides can become louder. This does not affect the functionality of the oven or accessories.



1.	Turn on the oven. Rotate the KNOB to select Cleaning . Confirm the selection by pressing the KNOB.
2.	The display shows three cleaning levels and the duration. Rotate the KNOB to select the cleaning level (see table above).
3.	Press ▷ ◻ . Confirm the selection by pressing the KNOB.
4.	The oven door locks automatically after a certain time for your safety.

Table continued from last page

5.	When the pyrolysis programme is finished, the display will show infoPyroLock and a short beep will be emitted. When the oven has cooled down, the door will be unlocked automatically. Once the oven cavity has fully cooled down, wipe it with hot soapsuds and a soft cloth to remove any residue (e.g. ashes).
----	--

⚠ WARNING!

During pyrolysis, unpleasant odours and smoke, as well as irritating vapours and gases, may be emitted. Therefore, make sure that the room is well-ventilated during the procedure and do not stay in that room for prolonged periods of time. Do not allow children or pets to come close to the oven.

During the pyrolysis process, food and fat residues may ignite. Therefore, remove all impurities from the oven interior before starting the process.

Appliance exterior will heat up to a high temperature during the pyrolytic cleaning process. Do not touch the oven door and never hang and combustible objects, such as kitchen cloths or towels, on the door handle.

Do not attempt to open the door while it is locked (during pyrolytic cleaning and while the appliance is cooling down after the process)! The cleaning process may be terminated and there is a risk of burns!

Small animals or pets can be particularly sensitive to any fumes. We recommend removing them from the room during the pyrolytic cleaning process and ventilating the room thoroughly once the cleaning process is complete.

12.2 Removing wire and fixed pull-out (extendible) guides

💡 INFORMATION!

When removing the guides, take care not to damage the enamel coating.

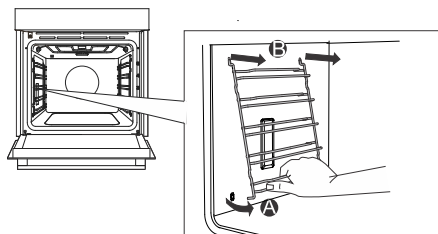

1.	Hold the guides by the bottom side and pull them towards the center of the oven cavity.
2.	Remove them from the openings at the top.

12.3 Removing and replacing the oven door and glass panes

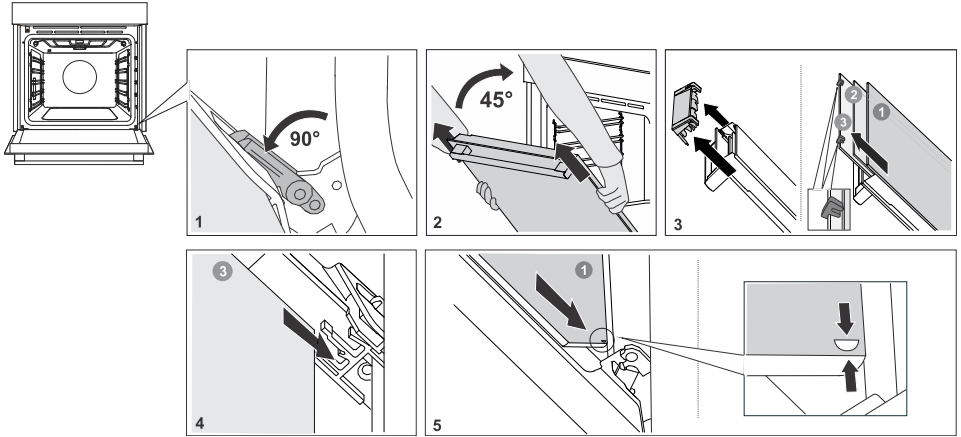

1.	First, fully open the door (as far as it will go).
2.	Oven door is attached to the hinges with special supports that also include safety levers. Rotate the safety levers towards the door by 90°. Slowly close the door to a 45° angle (relative to the position of the fully closed door); then, lift the door and pull it out. The oven door glass can be cleaned from the inside, but it has to be removed from the appliance door first. First do as described in point 2, but do not remove it.
3.	Remove the air guide. Hold it on the left- and right-hand side of the door with your hands. Remove it by slightly pulling it towards you.
4.	Hold the door glass at the upper edge and remove it. To the same for the second and third glass pane (depending on the model).
5.	To replace the glass panes, observe the reverse order.

INFORMATION!

To replace the door, follow the reverse order. If the door does not open or close properly, make sure the notches on the hinges are aligned with the hinge beds.

WARNING!

The oven door hinge can close with considerable force. Therefore, always rotate both safety levers to the support when fitting or removing the appliance door.

Soft door closing and opening

(depending on the model)

Oven door is fitted with a system that dampens the door closing force, starting at the a 75° angle. It allows simple, quiet, and gentle opening and closing of the door. A gentle push (to a 15° angle relative to the closed door position) is enough for the door to close automatically and softly.



WARNING!

If the force applied to close the door is too strong, the effect of the system is reduced and the safety mechanism effect is decreased.

12.4 Replacing the bulb

The light bulb is a consumable and is not covered by warranty. Before changing the bulb, remove any utensils from the oven.

Halogen bulb: G9, 230 V, side bulb - 25W and ceiling bulb - 40W.



WARNING!

Only replace the light bulb when the appliance is disconnected from the power supply. Be careful not to damage the enamel. Use protection to avoid burns.

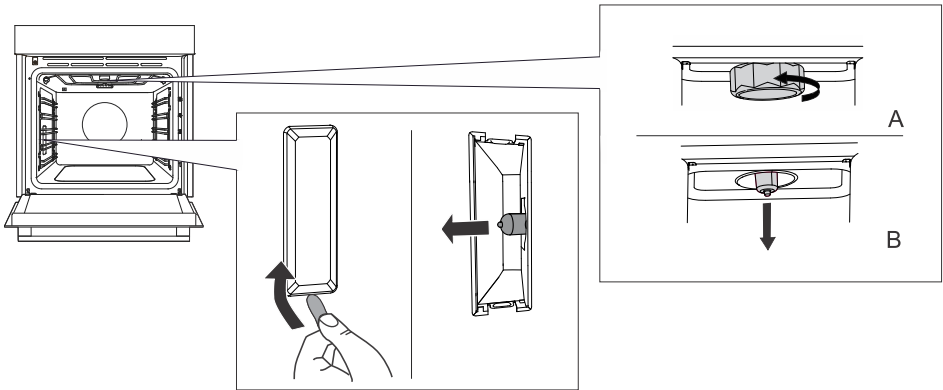

1.	Unscrew and remove the cover (in anti-clockwise direction). Remove the halogen bulb.
2.	Use a flat plastic tool to remove the cover. Remove the halogen bulb.

13. Troubleshooting

During the warranty period, only a service center authorized by the manufacturer may carry out any repairs.

- Before making any repairs, make sure the appliance is disconnected from the power mains either by removing the fuse or by disconnecting the power plug from the wall outlet.
- Any unauthorized repairs of the appliance may result in electric shock and short circuit hazard; therefore, do not perform them. Leave such work to an expert or a service technician.
- In case of minor problems with appliance operation, check this manual to see if you can fix the problem yourself.
- If the appliance is not operating properly or at all due to inappropriate operation or handling, a visit from a service technician shall not be free of charge, even during the warranty period.
- Save the instructions for future reference and pass them on to any subsequent owners or users of the appliance.
- Following is some advice on rectifying some common problems.

13.1 Troubleshooting table

Problem/error	Cause
The main fuse in your home trips often.	Call a service technician.
The oven lighting does not work.	The process of changing the light bulb in the oven is described in the chapter Replacing the bulb.
Control unit is not responding, the screen is frozen.	Disconnect the appliance from the power mains for a few minutes (undo the fuse or switch off the main switch); then, reconnect the appliance and switch it on.
The display shows the error Err X. In case of a double-digit error code, the display will show Err XX.	There is an error in the electronic module operation. Disconnect the appliance from the power mains for a few minutes. If the error is still indicated, call a service technician.
The display shows Cooking with meat probe, but the temperature probe is not connected.	Clean the socket. Try to connect and disconnect the food probe several times in succession.
Insufficient roasting on the bottom side.	Make sure that the correct cooking programme has been selected.
Steam accumulating on the display when opening the door.	Open the oven door completely, do not keep it somewhat closed.
Large amount of steam when cooking.	Certain foods contain a lot of water, so a large amount of steam is normal.
Meat probe appears on the screen, although it is not in use.	The cause of the error may be drops or dirt in the socket of the meat probe. We recommend inserting and removing the meat probe several times to clean the socket.
If the problems persist despite observing the above advice, call an authorized service technician. Repair or any warranty claim resulting from incorrect connection or use of the appliance shall not be covered by the warranty. In this case, the user will cover the cost of repair.	

13.2 Label – appliance information

A rating plate with basic information about the appliance is attached to the edge of the oven. Precise information on appliance type and model can also be found on the warranty sheet.

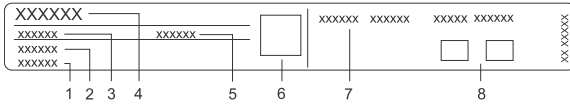

- | | |
|------------------|------------------------------|
| 1. Serial number | 5. ID/code |
| 2. Model | 6. QR code |
| 3. Type | 7. Technical information |
| 4. Brand | 8. Compliance labels/symbols |

14. Compliance information

Radio equipment type:	Built-in WiFi/BLE module
Wi-Fi indicator	
Operating frequency range:	2412 ~ 2472 MHz
Maximum output power:	19.99 dBm EIRP
Maximum antenna gain:	3.26 dBi
Bluetooth indicator	
Frequency range:	2402 ~ 2480 MHz
Carrier Output:	10.00 dBm
Emission type:	F1D

The company declares that the device with the function Connectlife complies with the essential requirements and other relevant provisions of Directive 2014/53/EU. The detailed Declaration of Conformity can be found at the web address <https://auid.connectlife.io> on the page of your device among the additional documents.



INFORMATION!

The project uses the LVGL graphics library as its graphical user interface.

15. Environment protection



Our product packaging is made of environmentally friendly materials that can be recycled, disposed of, or destroyed without any hazard to the environment. To this end, packaging materials are labelled appropriately.

The symbol on the product or its packaging indicates that the product should not be treated as normal household waste. Take the product to an authorized collection centre for waste electric and electronic equipment processing.

Correct **disposal** of the product will help prevent any negative effects on the environment and health of people, which could occur in case of incorrect product removal. For detailed information on removal and processing of the product, please contact the relevant municipal body in charge of waste management, your waste disposal service, or the store where you bought the product.

We reserve the right to any changes and errors in the instructions for use.

16. Cooking test

EN60350-1: Only use equipment supplied by the manufacturer.

Always insert the baking tray all the way to the end position on the wire guide. Place pastry or cakes baked in moulds as shown in the image.

* Preheat the appliance to desired temperature. Do not use the rapid preheat mode.

** Preheat the appliance for 10 minutes. Do not use the rapid preheat mode.

*** Turn after 2/3 of cooking time.























BAKING						
Dish	Equipment	mould placement		 °C	 min	
shortbread – single rack	shallow baking tray		3	150	25-40	
shortbread – single rack	shallow baking tray		3	135 **	35-50	
shortbread – two racks/levels	shallow baking tray		2, 4	140 **	25-45	
shortbread – three racks/levels	shallow baking tray		1, 4, 5	135	45-60	
small cakes – single rack	shallow baking tray		3	160-170 **	20-30	
small cakes – single rack	shallow baking tray		3	155-160 **	20-30	
small cakes – two racks/levels	shallow baking tray		1,5	140-150 **	30-45	
small cakes – three racks/levels	shallow baking tray		1, 3, 5	140-150	30-50	
sponge cake	round metal mould, diameter 26 cm/wire rack		3	170	30-45	
sponge cake	round metal mould, diameter 26 cm/wire rack		2	160	45-55	
sponge cake – two racks/levels	2 × round metal mould, diameter 26cm/wire rack		2, 4	170 *	45-55	
apple pie	2 × round metal mould, diameter 20cm/wire rack		2	160 **	70-120	
apple pie	2 × round metal mould, diameter 20cm/wire rack		2	160	70-120	
BROILING						
toast	wire rack		5	High	4-7	

Table continued from last page

BAKING						
beef burgers	wire rack + shallow baking sheet as drip tray		5	High	25-40	

gorenje



940975-a8

CE