

Operating Instructions Digital High Definition Plasma Television

Manual de instrucciones

Televisor digital con pantalla de plasma de alta definición

Model No. **TH-37PX60U**

Número de modelo **TH-42PX60U**

TH-50PX60U

TH-50PX60X

TH-58PX60U



For assistance, please call : **1-888-VIEW-PTV (843-9788)**
or contact us at www.panasonic.com/contactinfo

(U.S.A.)

For assistance, please call : **787-750-4300**
or visit us at www.panasonic.com

(Puerto Rico)

For assistance, please call : **1-800-561-5505**
or visit us at www.panasonic.ca

(Canada)

Para solicitar ayuda, llame al: **1-888-VIEW-PTV (843-9788)**
ó visítenos en www.panasonic.com/contactinfo

(EE.UU.)

Para solicitar ayuda, llame al: **787-750-4300**
ó visítenos en www.panasonic.com

(Puerto Rico)

English

Español

Please read these instructions before operating your set and retain them for future reference.
The images shown in this manual are for illustrative purposes only.

Lea estas instrucciones antes de utilizar su televisor y guárdelas para consultarlas en el futuro.
Las imágenes mostradas en este manual tienen solamente fines ilustrativos.

Turn your own living room into a movie theater!
Experience an amazing level of multimedia excitement



Manufactured under license from Dolby Laboratories.
"Dolby" and the double-D symbols are trademarks of
Dolby Laboratories.



HDMI, the HDMI logo and High-Definition
Multimedia Interface are trademarks
or registered trademarks of HDMI Licensing LLC.



SD Logo is a
trademark.

Contents

Be Sure to Read

- Safety Precautions..... 4
(Warning/Caution)
- Notes..... 5

- Accessories/Options 6
- **Connection** 10
- Identifying Controls 12
- **First Time Setup** 13

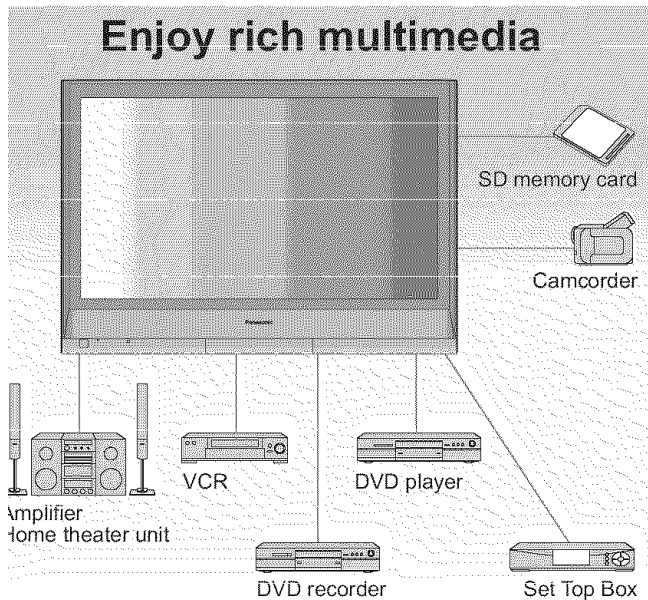

Enjoy your TV !

Basic Features

- Watching TV..... 14
- Viewing from SD Card 16
- SD Cards: Notes and Cautions..... 18
- Watching Videos and DVDs..... 19

Advanced Features

- How to Use Menu Functions
(picture, sound quality, etc.)..... 20
- Control with HDMI "HDAVI Control™" 22
- Channel Lock 26
- Editing and Setting Channels 28
- Input Labels/Closed Caption..... 30
- Using Timer..... 32
- Operating Peripheral Equipment 33
- Recommended AV Connections 34

FAQs, etc.

- Remote Control Operation/Code List..... 36
- Ratings List for Channel Lock..... 39
- Technical Information 40
- Maintenance 43
- FAQ..... 44
- Specifications..... 46
- Limited Warranty (for U.S.A.)..... 48
- Customer Services Directory (for U. S. A.)..... 49
- Limited Warranty (for Canada)..... 50

<p>HDAVI Control™ is a trademark of Matsushita Electric Industrial Co., Ltd.</p>	
----------------------------------------------------------------------------------	-------------------------------------------------------------------------------------

Safety Precautions

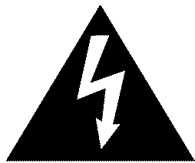

CAUTION

**RISK OF ELECTRIC SHOCK
DO NOT OPEN**



The lightning flash with arrow-head within a triangle is intended to tell the user that parts inside the product are a risk of electric shock to persons.



The exclamation point within a triangle is intended to tell the user that important operating and servicing instructions are in the papers with the appliance.

WARNING: To reduce the risk of electric shock, do not remove cover or back. No user-serviceable parts inside. Refer servicing to qualified service personnel.

WARNING: To reduce the risk of fire or electric shock, do not expose this apparatus to rain or moisture. Do not place liquid containers (flower vase, cups, cosmetics, etc.) above the set (including on shelves above, etc.).

Important Safety Instructions

- 1) Read these instructions.
- 2) Keep these instructions.
- 3) Heed all warnings.
- 4) Follow all instructions.
- 5) Do not use this apparatus near water.
- 6) Clean only with dry cloth.
- 7) Do not block any ventilation openings. Install in accordance with the manufacturer's instructions.
- 8) Do not install near any heat sources such as radiators, heat registers, stoves, or other apparatus (including amplifiers) that produce heat.
- 9) Do not defeat the safety purpose of the polarized or grounding-type plug. A polarized plug has two blades with one wider than the other. A grounding type plug has two blades and a third grounding prong. The wide blade or the third prong are provided for your safety. If the provided plug does not fit into your outlet, consult an electrician for replacement of the obsolete outlet.
- 10) Protect the power cord from being walked on or pinched particularly at plugs, convenience receptacles, and the point where they exit from the apparatus.
- 11) Only use attachments / accessories specified by the manufacturer.
- 12) Use only with the cart, stand, tripod, bracket, or table specified by the manufacturer, or sold with the apparatus. When a cart is used, use caution when moving the cart / apparatus combination to avoid injury from tip-over.
- 13) Unplug this apparatus during lightning storms or when unused for long periods of time.
- 14) Refer all servicing to qualified service personnel. Servicing is required when the apparatus has been damaged in any way, such as power-supply cord or plug is damaged, liquid has been spilled or objects have fallen into the apparatus, the apparatus has been exposed to rain or moisture, does not operate normally, or has been dropped.
- 15) To prevent electric shock, ensure the grounding pin on the AC cord power plug is securely connected.



FCC STATEMENT

This equipment has been tested and found to comply with the limits for an Other Class B digital device, pursuant to Part 15 of the FCC Rules. These limits are designed to provide reasonable protection against harmful interference in a residential installation. This equipment generates, uses and can radiate radio frequency energy and, if not installed and used in accordance with the instructions, may cause harmful interference to radio communications. However, there is no guarantee that interference will not occur in a particular installation. If this equipment does cause harmful interference to radio or television reception, which can be determined by turning the equipment off and on, the user is encouraged to try to correct the interference by one of the following measures:

- Reorient or relocate the receiving antenna.
- Increase the separation between the equipment and receiver.
- Connect the equipment into an outlet on a circuit different from that to which the receiver is connected.
- Consult the Panasonic Service Center or an experienced radio/TV technician for help.

FCC Caution:

To assure continued compliance, use only shielded interface cables when connecting TV to peripheral devices. Any changes or modifications not expressly approved by responsible party may cause harmful interference and could void the user's authority to operate this device.

Responsible Party: Panasonic Corporation of North America
One Panasonic Way, Secaucus, NJ 07094
Contact Source: Panasonic Consumer Electronics Company
1-888-VIEW-PTV (843-9788)
email: consumerproducts@panasonic.com

CANADIAN NOTICE:

For Models TH-37PX60U, TH-42PX60U, TH-50PX60U, TH-50PX60X, TH-58PX60U
This Class B digital apparatus complies with Canadian ICES-003.

⚠ WARNING

SMALL PARTS CAN PRESENT CHOKING HAZARD IF ACCIDENTALLY SWALLOWED. KEEP SMALL PARTS AWAY FROM YOUNG CHILDREN. DISCARD UNNEEDED SMALL PARTS AND OTHER OBJECTS, INCLUDING PACKAGING MATERIALS AND PLASTIC BAGS/SHEETS TO PREVENT THEM FROM BEING PLAYED WITH BY YOUNG CHILDREN, CREATING THE POTENTIAL RISK OF SUFFOCATION.

■ Set up

Do not place the Plasma TV on sloped or unstable surfaces.

- The Plasma TV may fall off or tip over.

Do not place any objects on top of the Plasma TV.

- If water spills onto the Plasma TV or foreign objects get inside it, a short-circuit may occur which could result in fire or electric shock. If any foreign objects get inside the Plasma TV, please consult an Authorized Service Center.

This Plasma TV is for use only with the following optional accessories. Use with any other type of optional accessories may cause instability which could result in the possibility of injury.

(All of the following accessories are manufactured by Matsushita Electric Industrial Co., Ltd.)

- Wall-hanging bracket (Vertical):
TY-WK42PV3U (TH-37PX60U, TH-42PX60U, TH-50PX60U, TH-50PX60X, TH-58PX60U)
- Wall-hanging bracket (Angled):
TY-WK42PR2U, TY-WK42PR3U (TH-37PX60U, TH-42PX60U, TH-50PX60U, TH-50PX60X)

Always be sure to ask a qualified technician to carry out set-up.

■ AC Power Supply Cord

The Plasma TV is designed to operate on 120 V AC, 50/60 Hz (TH-37PX60U, TH-42PX60U, TH-50PX60U, TH-58PX60U) or on 110 - 127 V AC, 50/60 Hz (TH-50PX60X). Securely insert the power cord plug as far as it will go.

- If the plug is not fully inserted, heat may be generated which could cause fire. If the plug is damaged or the wall socket plate is loose, they should not be used.

Do not handle the power cord plug with wet hands.

- Doing so may cause electric shocks.

Do not do anything that might damage the power cable.

When disconnecting the power cable, hold the plug, not the cable.

- Do not make any modifications to, place heavy objects on, place near hot objects, heat, bend, twist or forcefully pull the power cable. Doing so may cause damage to the power cable which can cause fire or electric shock. If damage to the cable is suspected, have it repaired at an Authorized Service Center.

■ If problems occur during use

If a problem occurs (such as no picture or no sound), or if smoke or an abnormal odor is detected from the Plasma TV, unplug the power cord immediately.

- Continued use of the TV under these conditions might cause fire or permanent damage to the unit. Have the TV evaluated at an Authorized Service Center. Servicing of the TV by any unauthorized personnel is strongly discouraged due to its high voltage dangerous nature.

If water or foreign objects get inside the Plasma TV, if the Plasma TV is dropped, or if the cabinet becomes damaged, disconnect the power cord plug immediately.

- A short may occur, which could cause fire. Contact an Authorized Service Center for any repairs that need to be made.

⚠ CAUTION

Do not cover the ventilation holes.

- Doing so may cause the Plasma TV to overheat, which can cause fire or damage to the Plasma TV.

If using the pedestal, leave a space of 3 15/16" (10 cm) or more at the top, left and right, 2 3/8" (6 cm) or more at the bottom, and 2 3/4" (7 cm) or more at the rear.

■ When using the Plasma TV

Be sure to disconnect all cables before moving the Plasma TV.

- Moving the TV with its cables attached might damage the cables which, in turn, can cause fire or electric shock.
- Disconnect the power plug from the wall outlet as a safety precaution before carrying out any cleaning.**
- Electric shocks can result if this is not done.
- Clean the power cable regularly to prevent it from becoming dusty.**
- Built-up dust on the power cord plug can increase humidity which might damage the insulation and cause fire. Unplug the cord from the wall outlet and clean it with a dry cloth.

This Plasma TV radiates infrared rays; therefore, it may affect other infrared communication equipment.

Install your infrared sensor in a place away from direct or reflected light from your Plasma TV.

Do not climb up onto the television or use it as a step.

(Young children should be made particularly aware of this caution.)

- If the unit falls over or becomes damaged through misuse, injury may result.

The TV will still consume some power as long as the power cord is inserted into the wall outlet.

Notes

■ Do not display a still picture for a long time

This causes the image to remain on the plasma screen ("after image"). This is not considered a malfunction and is not covered by the warranty.

Typical still images

- Channel number and other logos
- Image displayed in 4:3 mode
- SD Card photo ● Video game ● Computer image

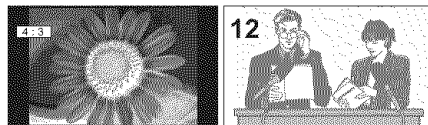

To prevent after image, the screen saver is automatically activated after a few minutes if no signals are sent or no operations are performed. (p. 45)

■ Setup

- Do not place the unit where it's exposed to sunlight or other bright light (including reflections).
- Use of some types of fluorescent lighting may reduce the remote control's transmission range.

Accessories/Options

Check you have all the items shown.

Accessories

- Remote Control Transmitter
● EUR7737Z20

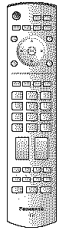

- Batteries for the Remote Control Transmitter (2)
● AA Battery

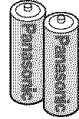

- Antenna Adapter
● F-Type for 5C-2V



- Cable clumper (2)

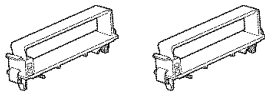

- AC cord

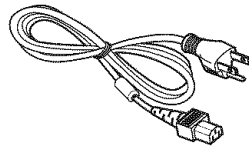

- Operating Instructions

- Product Registration Card (U.S.A.)

- Customer Care Plan Card (U.S.A.)

- Warranty Card (TH-50PX60X) (Mexico)

- Pedestal

- TBL2AX00011
(TH-37PX60U, TH-42PX60U)

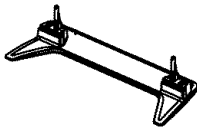

- TBL2AX00051
(TH-50PX60U, TH-50PX60X)

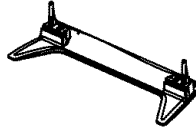

- TBL2AX00081
(TH-58PX60U)

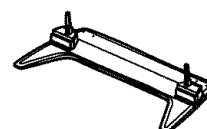

Installing remote's batteries

1

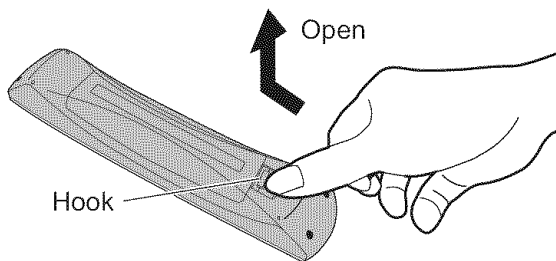

2

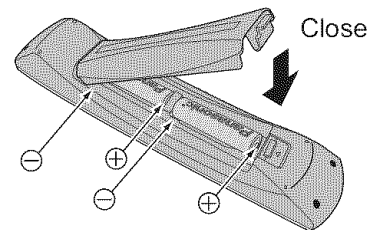

Note the correct polarity (+ or -).

Caution

- Incorrect installation may cause battery leakage and corrosion, resulting in damage to the remote control unit.
 - Do not mix old and new batteries.
 - Do not mix different battery types (such as alkaline and manganese batteries).
 - Do not use rechargeable (Ni-Cd) batteries.
- Do not burn or break batteries.
- Make a note of the remote control codes before changing batteries in case the codes are reset. (p. 37-38)

Optional accessories

Wall-hanging bracket (vertical)

- TY-WK42PV3U
(TH-37PX60U, TH-42PX60U, TH-50PX60U, TH-50PX60UX, TH-58PX60U)

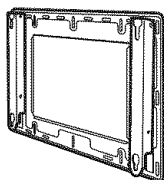

(angle)

- TY-WK42PR2U
● TY-WK42PR3U
(TH-37PX60U, TH-42PX60U, TH-50PX60U, TH-50PX60X)

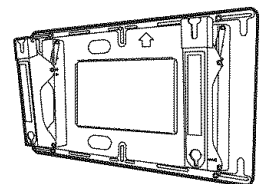

Attaching the pedestal to the plasma television

Caution

Do not use any television or displays other than those given in this manual.

● Otherwise the unit may fall over and become damaged, and personal injury may result.

Do not use the pedestal if it becomes warped or physically damaged.

● If you use the pedestal while it is physically damaged, personal injury may result. Contact your nearest Panasonic Dealer immediately.

During setting-up, make sure that all screws are securely tightened.

● If sufficient care is not taken to ensure screws are properly tightened during assembly, the pedestal will not be strong enough to support the plasma television, and it might fall over and become damaged, and personal injury may result.



Use the accessory fall-prevention brackets to secure the plasma television.

● If the unit is knocked or children climb onto the pedestal with the Plasma TV installed, the plasma television may fall over and personal injury may result.

Two or more people are required to install and remove the television.

● If two people are not present, the television may be dropped, and personal injury may result.

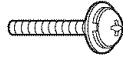
Accessories for pedestal assembly

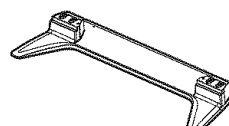
<p>(A) Assembly screw (4)</p>  <p>(37", 42", 50") M5 x 20 (58") M6 x 20</p>	<p>(B) Assembly screw (4)</p>  <p>M5 x 30</p>	<p>(C) Pole (2)</p> 	<p>(D) Base (1)</p> 
------------------------------------------------------------------------------------------------------------------------------------------------------------------	--------------------------------------------------------------------------------------------------------------------------------	--------------------------------------------------------------------------------------------------------	---------------------------------------------------------------------------------------------------------

1 Assembling the pedestal

■ Installing the poles

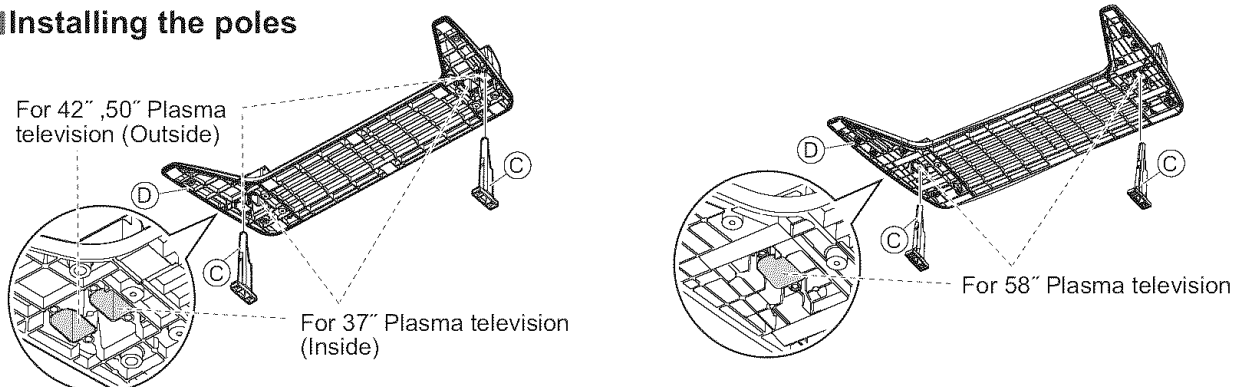

Insert the poles (C) into the left and right holes in the underside of the base (D) so that they fit securely as shown in the illustration above.

■ Securing the poles

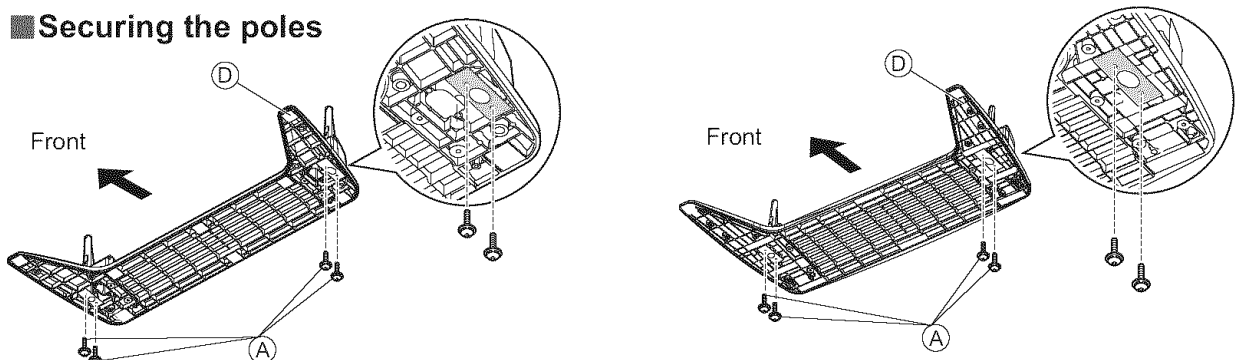

Use the assembly (A) screws to secure the poles firmly to the bottom of the base.

Note

Forcing the assembly screws the wrong way will strip the threads.

Accessories/Options

2 Setting-up

Television unit

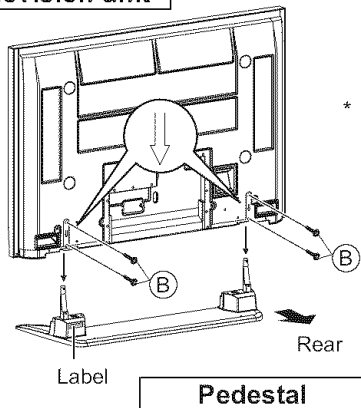

* Carry out work on a horizontal and level surface.

Lift the television unit above the pedestal base, with the back of the display unit on the same side as the Label. Then align the holes in the television unit with the poles of the pedestal and lower the television unit into place. Use the assembly screws (B) (M5 x 30) to fasten securely.

3 Stopping the plasma television from falling over

* The plasma TV must be fastened to both the base and the wall.

For 37", 42", 50" Plasma television

Accessories for pedestal security

① Band (2)

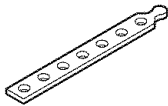

② Screw (2)

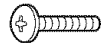

Nominal diameter
4 mm x 12

③ Wood screw (2)

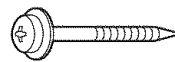

④ Clamp (2)



■ Securing to a base

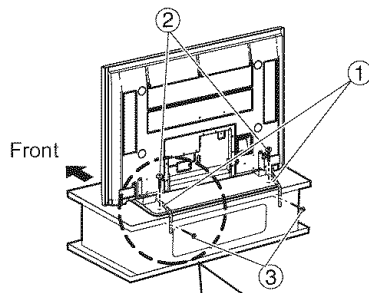

■ Securing to a wall

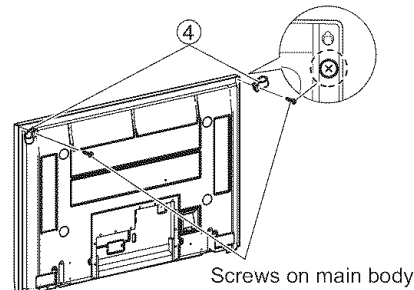



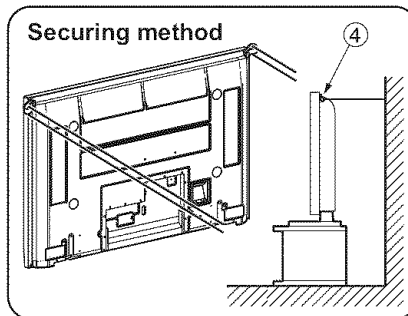
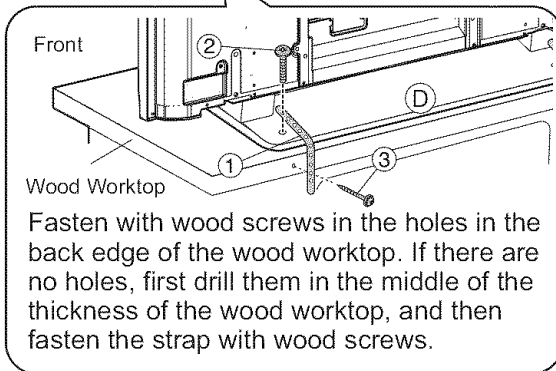

* Remove the screws at both top corners on the rear side of the plasma TV, and attach the clamps (4) to the plasma TV using the removed screws.

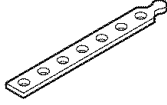

* Use strong wire or chain which is commercially available to secure the plasma television to a solid area of the wall or a pillar.

For 58" Plasma television

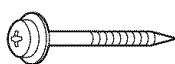
Accessories for pedestal security

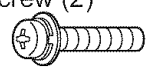
<p>① Band (4)</p> 	<p>② Screw (4)</p>  <p>Nominal diameter 4 mm x 12</p>	<p>③ Wood screw (4)</p> 	<p>④ Hook (2)</p> 	<p>⑤ Hook securing screw (2)</p>  <p>M8 x 35</p>
-----------------------------------------------------------------------------------------------------	--------------------------------------------------------------------------------------------------------------------------------------------	-----------------------------------------------------------------------------------------------------------	-------------------------------------------------------------------------------------------------------	-------------------------------------------------------------------------------------------------------------------------------------

■ Securing to a base.

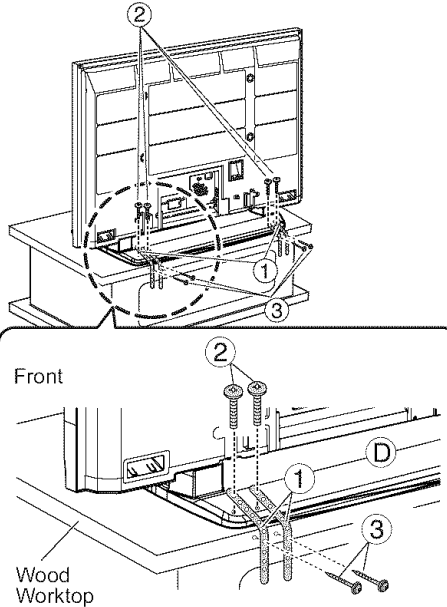

Fasten with wood screws in the holes in the back edge of the wood worktop. If there are no holes, first drill them in the middle of the thickness of the wood worktop, and then fasten the strap with wood screws.

■ Securing to a wall.

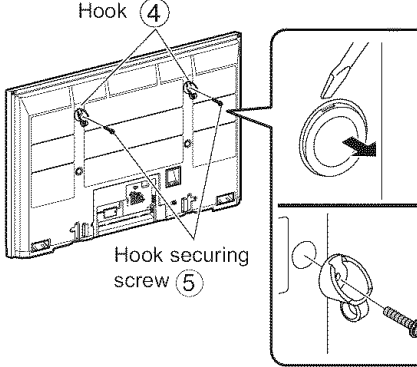

Hook (4)

Hook securing screw (5)

• Securing method

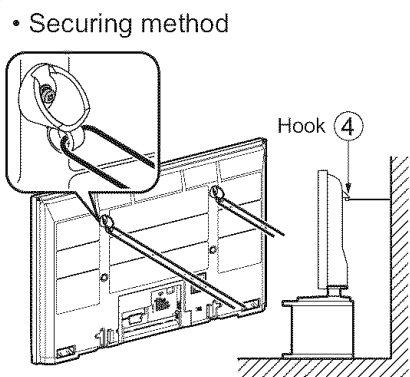

* Use a flat-head screwdriver to remove the caps at the left and right top on the rear side of the plasma TV, and attach the hooks (4) to the plasma TV using the hook securing screws (5). (Keep the caps you have removed in a safe place.)

* Use a strong wire or chain which is commercially available to secure the hooks (4) to a solid area of the wall or pillar.

Connection

■ Watching TV

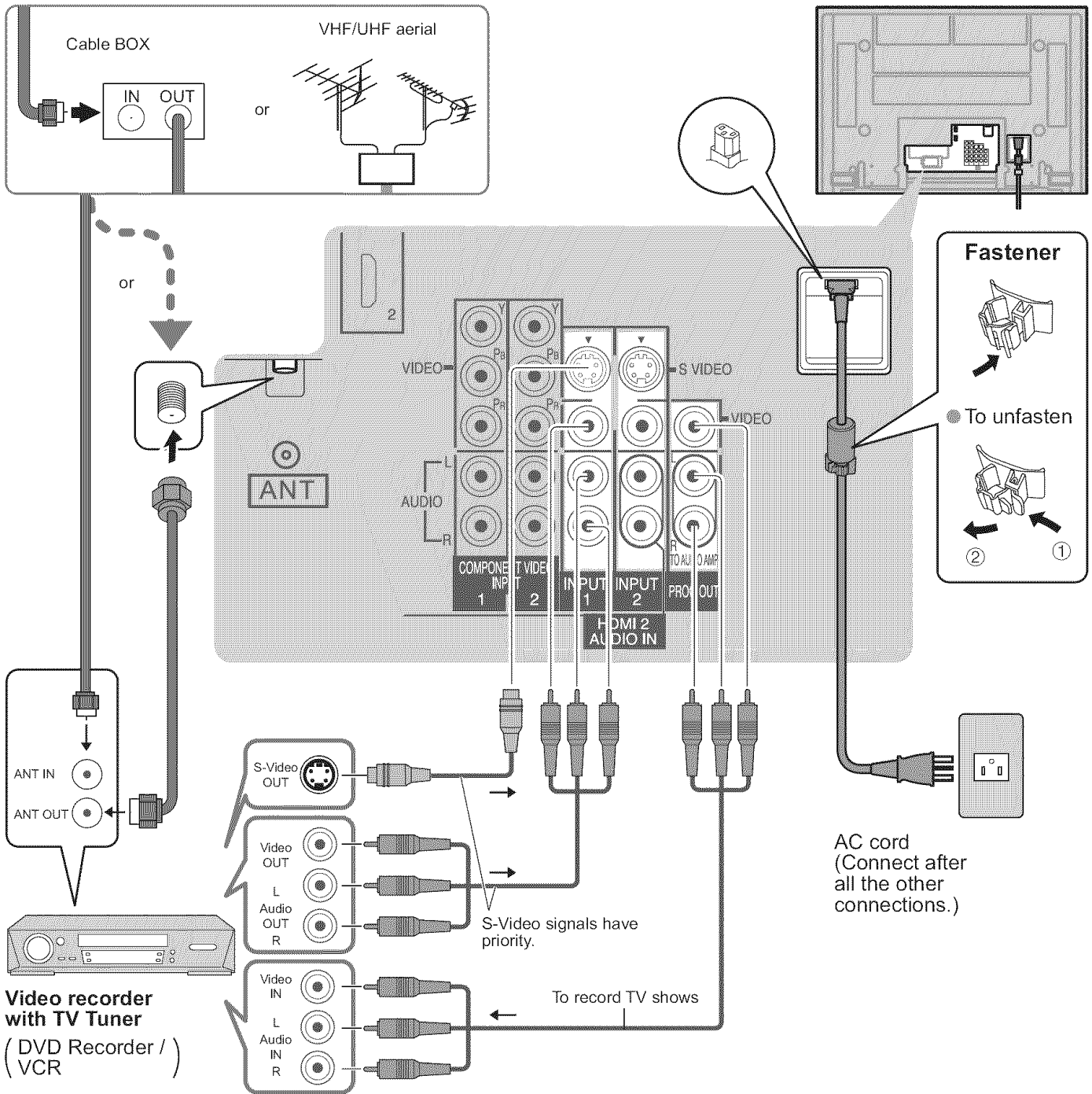

Note

- All cables and external equipment shown in this book are not supplied with the TV.
- For additional assistance, visit us at : www.panasonic.com
www.panasonic.ca
- The S Video input will override the composite video signal when S Video cable is connected. Connect either S Video cable or Video cable.
- When receiving digital channel signals, all digital formats are down-converted to composite NTSC video to be output through the PROG.OUT terminals.
- Some programs contain a copyright protection signal to prevent VCR recording.
- Set the TV channel to CH3 or CH4 for using Cable Box Connection.

Cable Binding Instructions

■ Attaching the Cable clampers

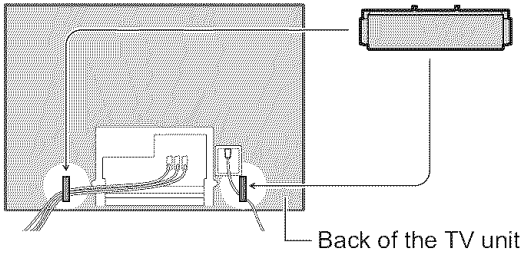

- Do not bundle the RF cable and AC cord together (could cause distorted image).
- Fix cables with Cable clampers as necessary.
- When using the optional accessory, follow the option's assembly manual to fix cables.

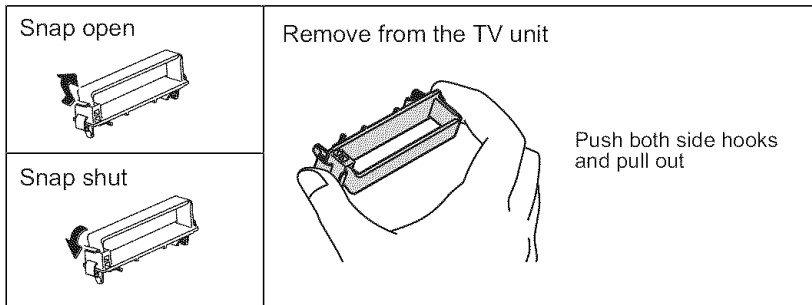

■ Cable Binding Instructions

Bind all cables to the plasma television with the Cable clamer.

- Bundle cables with the Cable clamer on the left side.
- Fasten the AC cord with the Cable clamer on the right side.

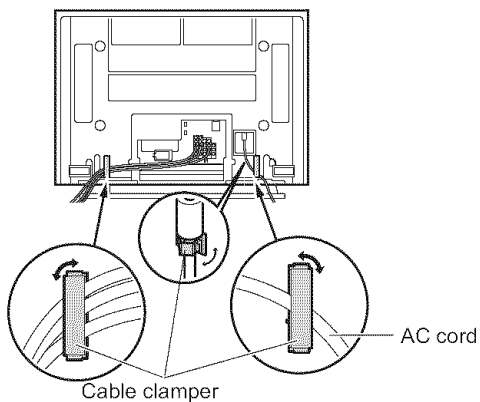

Identifying Controls

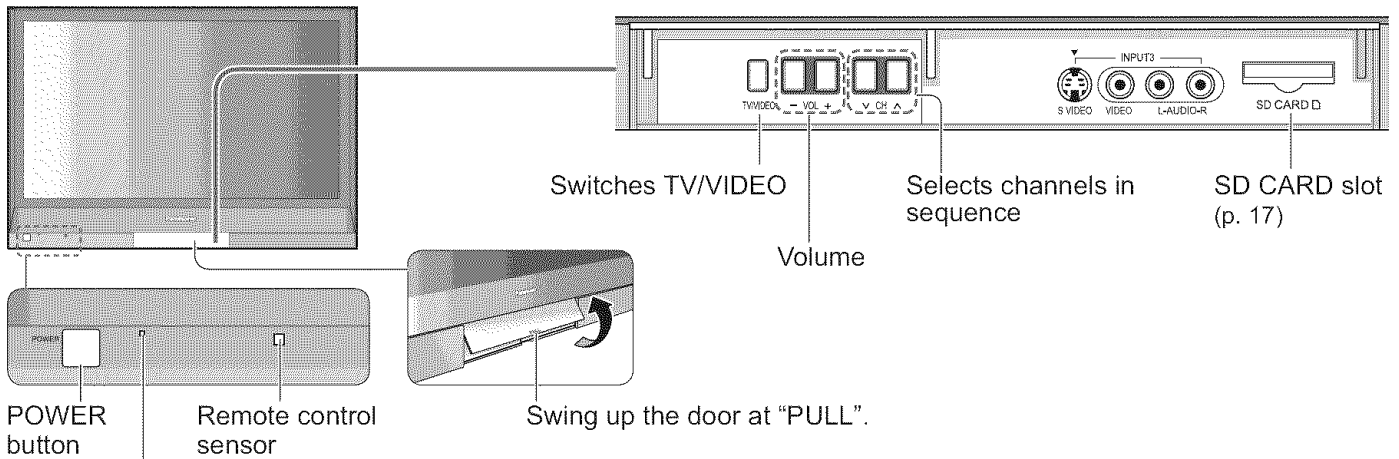

Power indicator (on: red, off: no light)

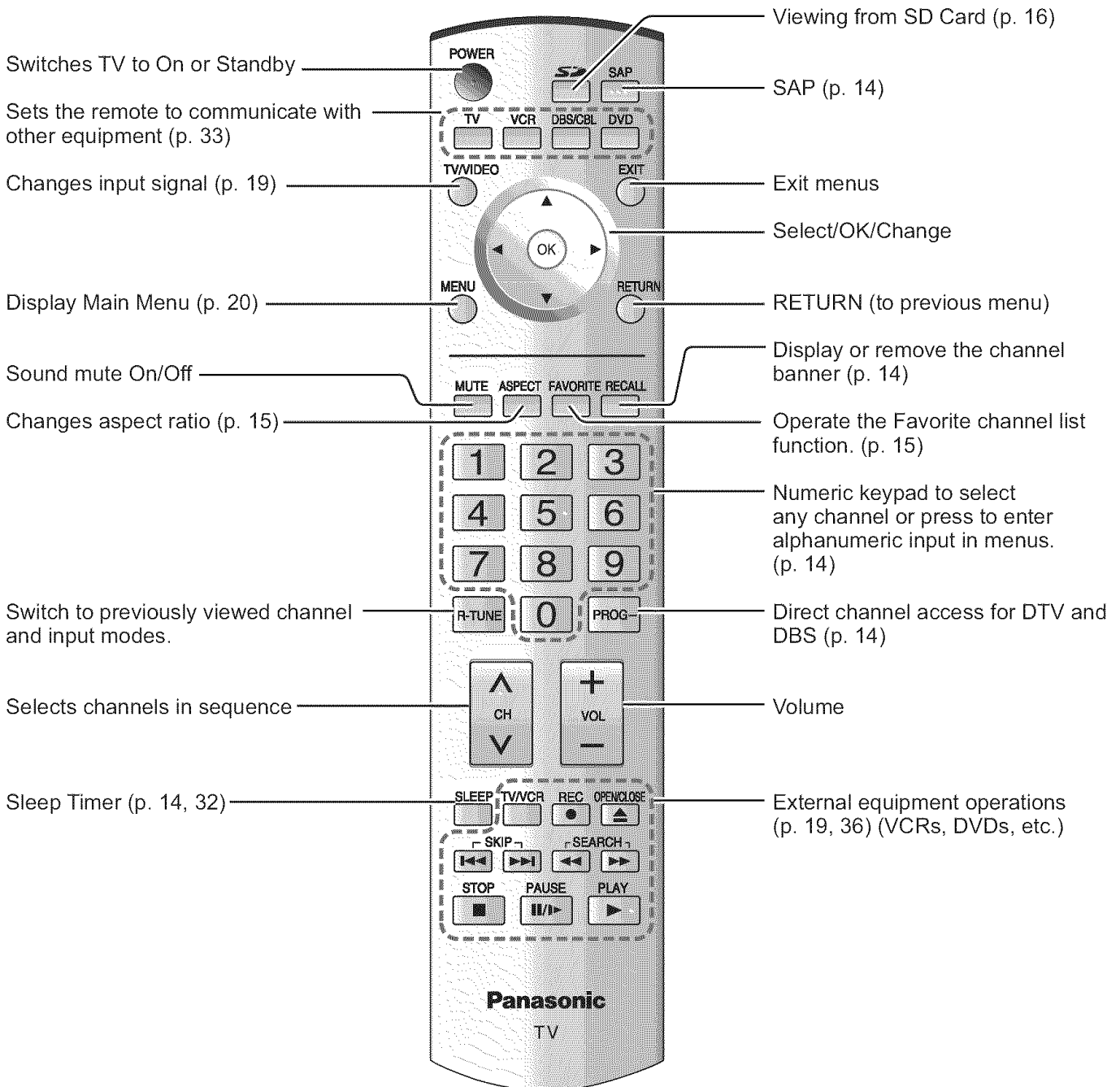

First Time Setup

“First time setup” is displayed only when the TV is turned on for the first time after the AC cord is inserted into a wall outlet. Available only when “Auto power on” (p. 20) is set to “Off”.

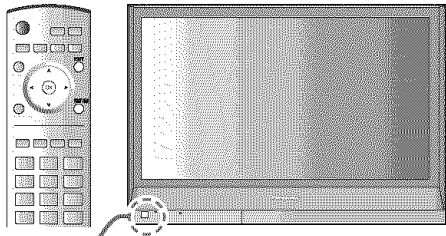

1 Turn the TV On with the POWER button

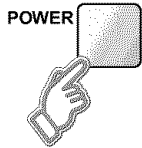

2 Select your language

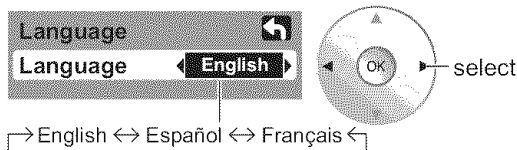
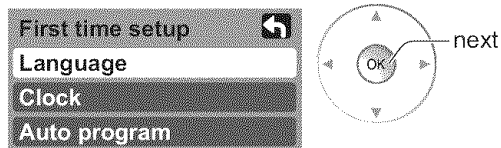

→ English ↔ Español ↔ Français ←

RETURN

Press to go to previous screen. Or, select icon, then press OK for same results.

3 Adjust the clock

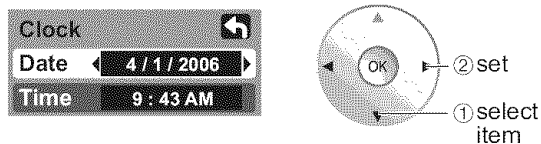
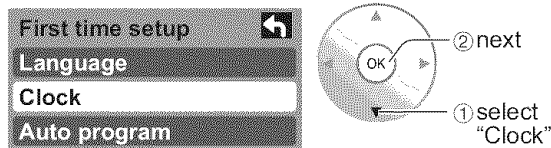

Date: Adjust the date (Press and hold to change the month.)

Time: Adjust the time (If the button is held, the speed of change increases.)

4 Auto channel setup

① Select “Auto program”

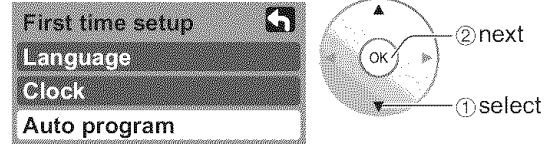

② Select antenna and input modes

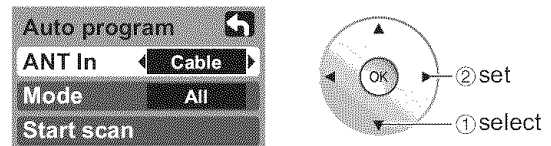

ANT In

Cable: Cable TV
Antenna: Antenna

Mode

All: digital and analog
Analog: analog only
(Reduces time for scanning)

- About broadcasting systems
Analog: traditional TV system
Digital: new system that allows you to view more channels featuring high-quality video and sound

③ Start scanning the channels

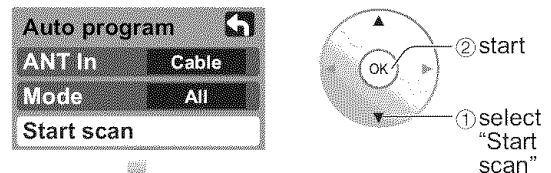

Available channels (analog/digital) are automatically set.

④ Confirm registered channels

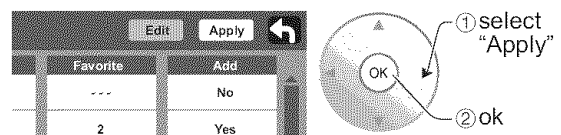

- If OK is not pressed after selecting “Apply”, the channels will not be memorized.

■ Press to exit

EXIT



■ Press to return to

previous screen RETURN



Note

- To change setting later, go to Menu screen (p. 20)

Watching TV

Connect cable Box when watching cable TV. (p. 10)

1 Switch to TV mode



2 Turn power on



- POWER button on unit should be On.

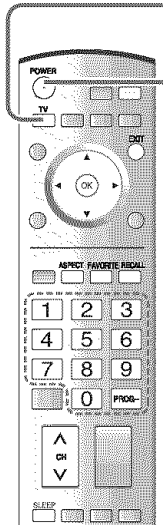



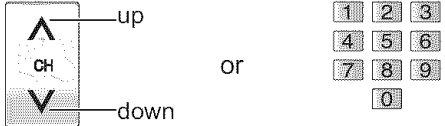

3 Select a channel number



■ To directly input the digital channel number



- When tuning digital channel, press the button to enter the minor number in a compound channel number.

example: CH15-1:    

■ Other Useful Functions (Operate after 3)

Sleep Timer

Switches the unit OFF in a preset amount of time from 0 to 90 minutes in 30 minute intervals.

SLEEP ● 0/30/60/90 (minutes)

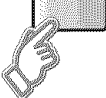

Listen with SAP (Secondary Audio Program)

■ Select Audio Mode for TV Viewing

SAP



- **Digital mode**
Press SAP to select the next audio track (if available) when receiving a digital channel.

Audio Track 1 of 1 (English)

- **Analog mode**
Press SAP to select the desired audio mode.
• Each press of SAP will change the audio mode. (Stereo/SAP/Mono)

Information Recall

Display or remove the channel banner.

RECALL



Channel	Ending time	Show title	Clock
15-2 ABC - HD	- 10:30	Andrew's cooking show	10:00 am
Station identifier	CC SAP SAP	TV-G Rating Level	1080i Signal resolution
		Standard Picture mode	4-3 Aspect ratio
			30 Sleep timer remaining time

Change aspect ratio

Change the aspect (p. 40)

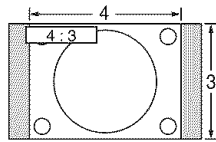
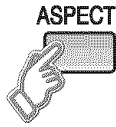

- Each press changes the mode.
- 480i (4:3), 480i (16:9), 480p (4:3), 480p (16:9) : FULL, JUST, 4:3 or ZOOM
- 1080p / 1080i / 720p : FULL, H-FILL, JUST, 4:3 or ZOOM.

Call up a favorite channel



FAVORITE

Channel numbers registered in Favorite are displayed on the favorite tune screen. Select the desired broadcast station with the cursor, or using number keys. (see below)

Caution

- ATSC broadcasts cannot be received in countries other than the USA, Canada, and Mexico.

Note

- Reselect "Cable" or "Antenna" in "ANT In" of "Auto program" to switch the signal reception between cable TV and antenna. (p. 13)
- The channel number and volume level remain the same even after the TV is turned off.

Set Favorite Feature

1 Display the channel to be placed on the Favorites list.

2 FAVORITE

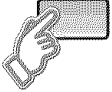

Hold down FAVORITE for several seconds.

- Press FAVORITE repeatedly to change between pages (1/3, 2/3, 3/3, or exit). Pressing ◀ ▶ also changes the page.

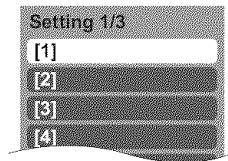

3 ① select

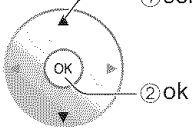

- Press ▲ ▼ to highlight a position on the list. Then, press OK to memorize the displayed CH in that position.
- You can also use the NUMBER keys (1-9 and 0) to select the recorded list numbers (1-9 and 0). By doing so, the numbers will be directly recorded without having to press the OK key.

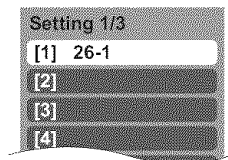

● To delete a favorite channel

A memorized channel can be removed from the list by holding down FAVORITE while its position is highlighted.

Use Favorite Feature

1 FAVORITE



Press FAVORITE.

- Press FAVORITE repeatedly to change between pages (1/3, 2/3, 3/3, or exit). Pressing ◀ ▶ also changes the page.

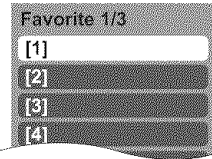

2 select

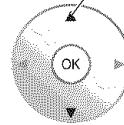

Press ▲ ▼ or a Numbered key (1-9 and 0) to highlight a channel on the list.

- Selecting a channel number from the list with the Number keys will display the channel directly.

3 ok



Press OK to display the highlighted channel.

Viewing from SD Card

You can view photos taken with a digital camera or a digital video camera saved on SD card.
(Media other than SD Cards may not be reproduced properly.)



- 1 Insert the SD Card**
● For cautions and details on SD Cards (p. 18 and 41)

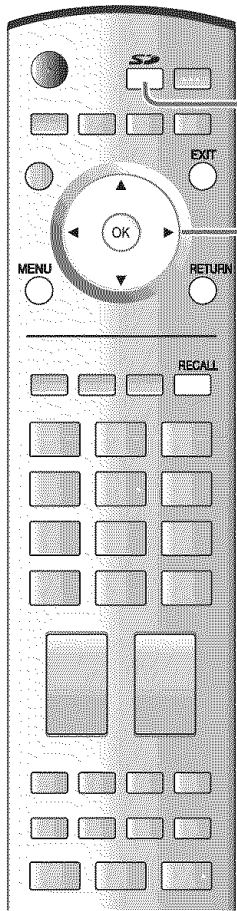

- 2 Select the SD mode**

- 3 Select the data to be viewed**

While reading the data

Thumbnail view

JPEG thumbnail

Accessing

Total 8

Info

No. 102-0008

Date 01/01/2000

Pixel 2048x1536

Select OK

Select (4)

MENU RETURN

Navigation Area

Selected picture information is displayed.
No. : Image number or file name is displayed.
Date : Date of recording is displayed.
Pixel : Display resolution is displayed.

Note

● Depending on the JPEG type, Info contents may not be displayed correctly.

Total number of images

① select

② view

■ Press to return to

TV



■ Press to exit

EXIT



■ Press to return to the previous screen

RETURN



- 4 View**

Navigation Area

To previous photo

Rotate 90 degree (clockwise)

To next photo

Rotate 90 degree (counter-clockwise)

Displayed one at a time

● To display/hide Navigation Area



Note

● This SD modes selection are able to operate from MENU screen.

SD Card

- Insert the card

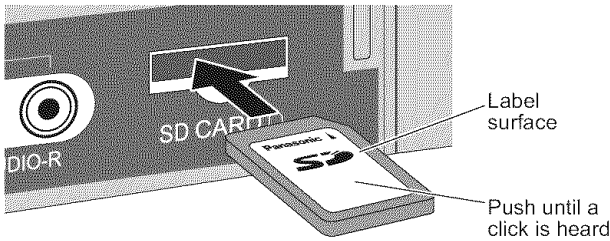

- Remove the card

➔ Press in lightly on SD Card, then release.

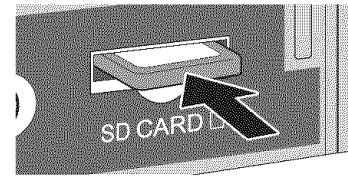

- Compliant card type (maximum capacity): SD Card (2 GB), Mini SD Card (1 GB) (requiring mini SD Card adapter)

To change the view (slide show, adjusting images, etc.)

■ To watch photos in slide show

In ④

Adjust

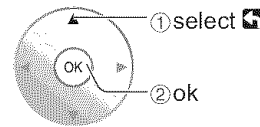
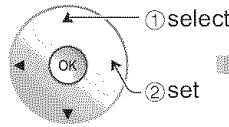
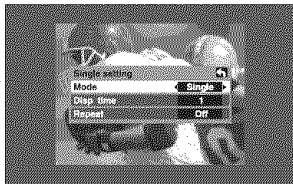
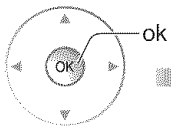

Start slide show

Mode	Set to Single/Slide to view single images or perform a slide show.
Disp time	You can set how many seconds each image is displayed in Slide mode.
Repeat	Turn the slide show Repeat function On or Off.

Note

- For large image sizes, the display time will be longer than the number of seconds set.
- To stop in mid-cycle ➔ Press "OK" button

■ To adjust picture

When MENU is pressed, the Picture Adjust menu is displayed. (p. 20)

In ④

MENU

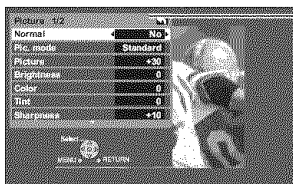
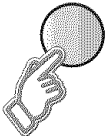

Picture menu (p. 20)

- To display/hide Navigation Area



SD Card: Notes and Cautions

Card Warning Messages

Message	Meaning
Is memory card in?	● The card is not inserted or this unit does not support the format.
No file	● The card has no data or this type of data is not supported.

Cautions in handling card :

- Do not remove the card while the unit is accessing data (this can damage card or unit).
- Do not touch the terminals on the back of the card.
- Do not subject the card to a high pressure or impact.
- Insert the card in the correct direction (otherwise, card may be damaged).
- Electrical interference, static electricity, or erroneous operation may damage the data or card.
- Back up the recorded data at regular intervals in case of deteriorated or damaged data or erratic operation of the unit. (Panasonic is not liable for any deterioration or damage of recorded data.)

Watching Videos and DVDs

Some Panasonic equipment connected to the TV unit can be operated with the remote control. Programming the remote control is necessary to operate other manufacturers' products. (p. 33)

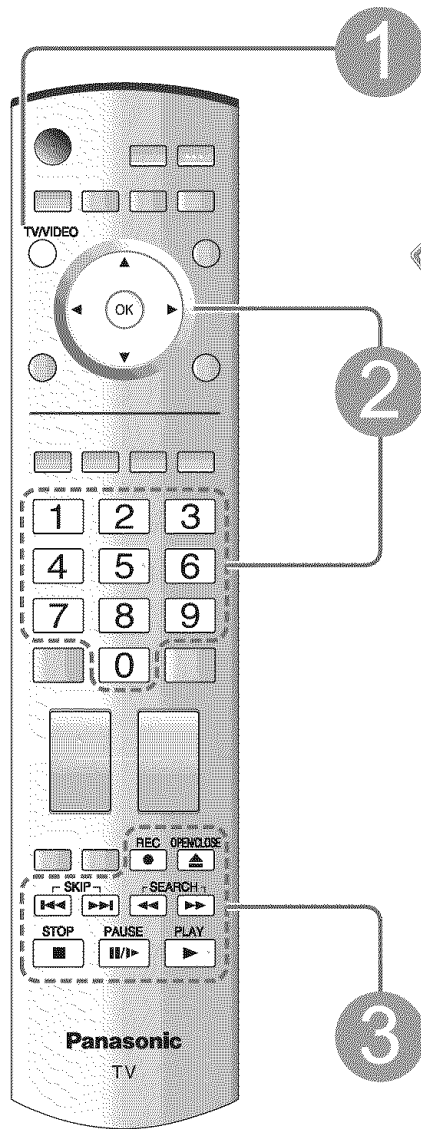

1 With VCR or DVD turned On
Switch to external input
 Press to display the Input select menu.
 TV/VIDEO

2 **Select the input mode**

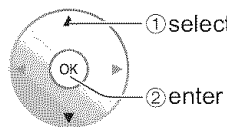
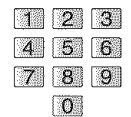

Press corresponding NUMBER key on the Remote Control to select the input of your choice.

Press to select the input of your choice, then press "OK".
 ● If during selection, no action is taken for several seconds, the Input selection menu is exited.

(Initial screen)

- The terminal and label of the connected device is indicated. To label each of the connected devices (p. 30)

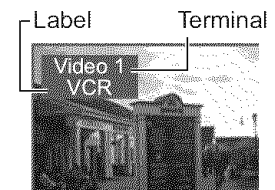

[example]

3 **Operate**
 the VCR or DVD with the remote control

(example)

■ Press to return to TV
 TV/VIDEO



Note

- For details, see the manual of the equipment or ask your local dealer.

	VCR	DVD
REC	VCR Record	Record
OPEN/CLOSE	—	Open/Close
SKIP	—	Skip Reverse/Forward
SEARCH	Rewind/Fast Forward	Reverse/Forward
STOP	Stop	Stop
PAUSE	Pause	Pause
PLAY	Play	Play

(For other operations, see p. 36.)

Viewing
 ● Watching Videos and DVDs
 ● Cards: Notes and Cautions

How to Use Menu Functions

Various menus allow you to select settings for the picture, sound, and other functions so that you can enjoy watching TV in your own way.

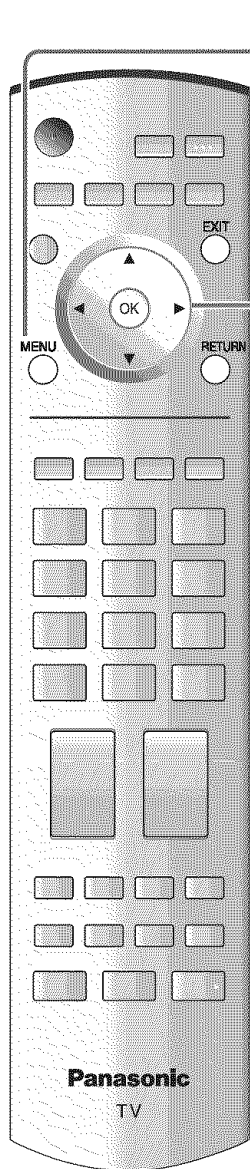

1 Display menu
MENU ● Displays the functions that can be set (varies according to the input signal)

2 Select the menu

Menu	
Picture	
Audio	
Timer	
Lock	
Memory card	
Setup	

① select
② next

3 Select the item

Picture 1/2	
Normal	No
Pic. mode	Standard
Picture	+30
Brightness	0
Color	0
Tint	0
Sharpness	+10

select

(example: Picture menu)

4 Adjust or select

Picture 1/2	
Normal	No
Pic. mode	Standard
Picture	+30
Brightness	0
Color	0
Tint	0
Sharpness	+10

adjust or select

(example: Picture menu)

■ Press to return to TV
EXIT

■ Press to return to the previous screen
RETURN

Menu list

Menu	Item	
Picture	Normal	
	Pic. mode	
	Picture, Brightness, Color, Tint, Sharpness	
	Color temp	
	Color mng.	
	Zoom adjust	
	Other adjust	Video NR
		3D Y/C filter
		Color matrix
		MPEG NR
Black level		
Audio	Normal	
	Bass	
	Treble	
	Balance	
	Other adjust	AI sound
		Surround
		Speakers
		HDMI1 in HDMI2 in
Audio leveler		
Timer	Sleep, Timer1-5	
Lock		
Memory Card		
Setup	CH scan	
	Language	
	Clock	
	Program channel	
	Input labels	
	CC	
	Other adjust	Auto power on
		Side bar
		Prog-out stop
		Ctrl with HDMI
Power off link Power on link		
About		
Reset		

Adjustments/Configurations (alternatives)

Resets all picture adjustments to factory default settings except for "Other adjust"	Normal	No
Basic picture mode (Vivid/Standard/Cinema) (p. 42)	Pic. mode	Standard
Adjusts color, brightness, etc. for each picture mode to suit your taste	Picture	+30
	Brightness	0
	Color	0
	Tint	0
	Sharpness	+10
Selects level of warm colors (red) and cool colors (blue) (Warm/Cool/Normal)	Color temp	Cool
On enhances green and blue color reproduction, especially outdoor scenes. (On/Off)	Color mng.	Off
Adjusts vertical alignment and size when aspect setting is "ZOOM" (p. 40)	Zoom adjust	
Reduces noise, commonly called snow. Leave off when receiving a strong signal. (On/Off)	Video NR	Off
Minimizes noise and cross-color in the picture. (On/Off)	3D Y/C filter	Off
Selects image resolution of component-connected devices (SD/HD)	Color matrix	SD
● SD: normal vision HD: high-definition vision	MPEG NR	Off
● Only 480p signal accepted; regular TV (NTSC) is not available.	Black level	Dark
Reduces noise of specific digital signals of DVD, STB, etc. (On/Off)	Normal	Set
Select Dark or Light. Valid only for external input signals. (Dark/Light)	Bass	+7
Reset Bass, Treble and Balance adjustments to factory default settings.	Treble	+7
Increase or decrease the bass response.	Balance	0
Increase or decrease the treble response.	AI sound	On
Emphasize the left / right speaker volume.	Surround	Off
Equalize overall volume levels across all channels and VIDEO inputs. (On/Off)	Speakers	On
Enhances audio response when listening to stereo. (On/Off)	HDMI1 in	Auto
Switches to "Off" when using external speakers (On/Off)	HDMI2 in	Auto
● "AI sound", "Surround" and "Audio leveler" do not work if "Off" is selected	Audio leveler	0
Selects according to the signal when HDMI is connected (Auto/Digital/Analog)	Sleep	60
● Auto: Automatically selects Analog / Digital signal		
Minimizes volume disparity after switching to external inputs		
The TV can automatically turn On/Off at the designated date and time. (p. 32)		
Locks the channels and programs (p. 26)		
Displays SD card data (p. 16)		
Selects the channel with "Program up/down" button (Fav./All)	CH scan	All
● Fav.: Only channels registered as FAVORITE (p. 15, 28)	Language	
Selects the screen menu language (p. 13)	Clock	
Adjusts the clock (p. 13)	Program channel	
Sets channels (p. 28)	Input labels	
Sets the terminal and the label of the external equipment (p. 30)	CC	
Displays subtitles (Closed Caption) (p. 30)	Auto power on	Off
Turns TV On automatically when the cable box or a connected device is turned On (Set/Off)	Side bar	Bright
● The Sleep Timer and On / Off timer will not function if "Auto power on" is set.	Prog-out stop	Off
Increases the brightness of the side bar (Off/Dark/Mid/Bright) (4:3 mode only)	Ctrl with HDMI	On
● The recommended setting is Bright to prevent panel "after image". (p. 42)	Power off link	Set
To prevent howling and image oscillation, stops output of the pictures and audio specified in this menu. (p. 35) (Off/Comp.1/Comp.2/HDMI 1/HDMI 2/Video 1/Video 2/Video 3)	Power on link	Set
Controls equipment connected to HDMI terminals (p. 22) (On/Off)	About	
● "Power off link" and "Power on link" do not work if "Off" is selected.	Reset	
Sets "Power off link" of HDMI connection equipment (p. 22) (Set/No)		
Sets "Power on link" of HDMI connection equipment (p. 22) (Set/No)		
Displays TV version and software license		
Performing Reset will clear all items set with Setup, such as channel settings. (p. 28)		

● In AV mode, the Audio menu and Setup menu give a smaller number of options.

Control with HDMI “HDAVI Control™”*

* Simultaneously control all Panasonic “HDAVI Control” equipped components using one-button on one remote.

Newer Panasonic audio-video products with HDMI output connections can be controlled using the TV’s remote. Limited features such as home theater system volume and automatic switching to the TV’s HDMI input are available.

- This feature is limited to models incorporating Panasonic’s “Control with HDMI”. Refer to the individual instruction manuals for compatibility information.
- Non-HDMI-compliant cables cannot be utilized.
- It is recommended that you use Panasonic’s HDMI cable.
Recommended part number: RP-CDHG15 (1.5 m), RP-CDHG30 (3.0 m), RP-CDHG50 (5.0 m)

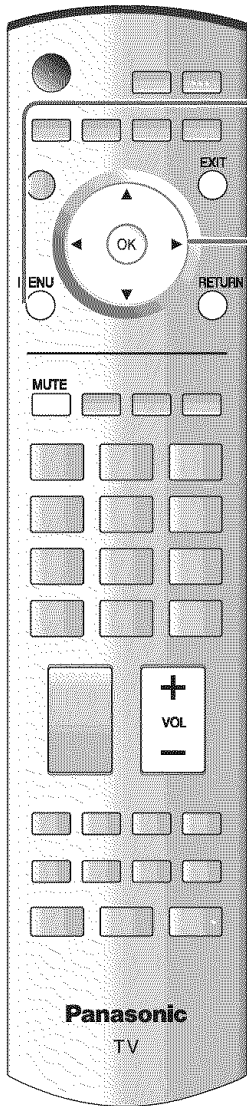

1 Display menu
MENU

2 Select “Setup”

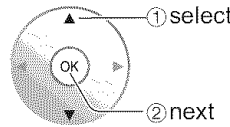
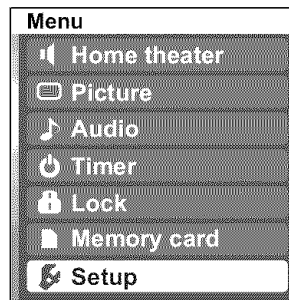

3 Select “Other adjust”

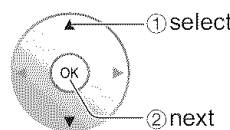
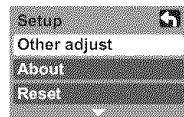

4 Select “Ctrl with HDMI”

Other adjust	
Auto power on	Off
Side bar	Off
Prog-out stop	Off
Ctrl with HDMI	On
Power off link	Set
Power on link	Set

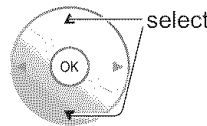

5 Select “On”

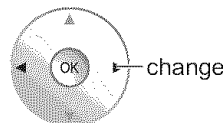

■ Press to return to TV
EXIT



■ Press to return to the previous screen
RETURN



● Default setting is “On”. If no HDMI equipment is connected or standard HDMI equipment (non- “Control with HDMI”) is used, set to “Off”.

Automatic input switching

Theater speaker

Power on link

Power off link

One-touch theater playback

At the start of DIGA, Player theater or RAM theater playback, the TV's input automatically switches to the input corresponding to the playback equipment.

- For RAM theater, the speakers automatically switch to theater.
- If using DIGA operation, the TV's input automatically switches to DIGA and the DIGA menu is displayed.

You can control the theater speaker with TV's remote control.

"Home theater" with speaker icon appears when a Panasonic "Control with HDMI" home theater system is connected via the HDMI input (1 or 2).

Pressing the OK button toggles between TV and home theater volume control.

- "Ctrl with HDMI" must be set to "On".
- Limited to newer Panasonic Home Theater, RAM theater and DIGA/DVD models with "Control with HDMI".

① Display menu 

② Select "Home theater" or "TV speakers"



■ **Home theater:**

Adjustment for Panasonic Amplifier, Panasonic Player theater, Panasonic RAM theater



■ **TV speakers:**

The TV speakers are active.

- When selecting "Home theater", the sound of TV speakers is mute.
- When "Home theater" is selected, the home theater volume control can be raised or lowered using the TV remote volume button. The TV will display "Home Theater + / -" on screen.
- If home theater/RAM theater/Player theater is currently off, selecting the "Home theater" option will automatically turn the equipment on. See "Power on link" below.
- If home theater/Player theater/RAM theater power is turned Off, speakers automatically switch to the TV.

When "Set" is selected, this allows for the TV to automatically turn on and switch to the appropriate HDMI input whenever a "Control with HDMI" compatible DVD player/recorder is initially turned on and Play mode is selected.

When "Set" is selected, this allows for the TV to turn off and also turn off the connected home theater/ RAM theater/player theater and/or DIGA-DVD player.

If the "ONE TOUCH PLAY" key is pressed on the AV amp or Player theater remote control, the following sequence of operations is performed automatically.

- ① Home theater/Player theater power switches On, and playback begins.
- ② TV power switches On, and the playback screen is displayed.
- ③ Audio is muted on the TV and switches to theater.

Caution

- "Control with HDMI" function does not work in countries other than the USA and Canada.
- The TV remains on even if the "Control with HDMI" compatible equipment is turned off.

Note

- Before using HDMI control functions, the connected equipment (DIGA, RAM theater, Player theater, AV amp) must also be set. For details, see the operation manual for each equipment.
- For equipment connection details, see p. 24.

Control with HDMI “HDAVI Control™”

Recommended HDMI Connections

Follow the connection diagrams below for HDMI control of a single AV piece of equipment such as a Panasonic DIGA-DVD recorder, RAM Theater or Player Theater system. Refer to page 22 for Setup Menu settings and additional control information.

● Optional HDMI and/or optical cables are not provided.

If connection (or setting) of equipment compatible with HDMI control is changed, switch the power of this unit Off then On again while the power of all equipment is On (to this unit to correctly recognize the connected equipment) and check that DIGA, RAM theater and Player theater playback operates.

■ Connecting this unit to a DVD recorder, RAM theater or Player theater

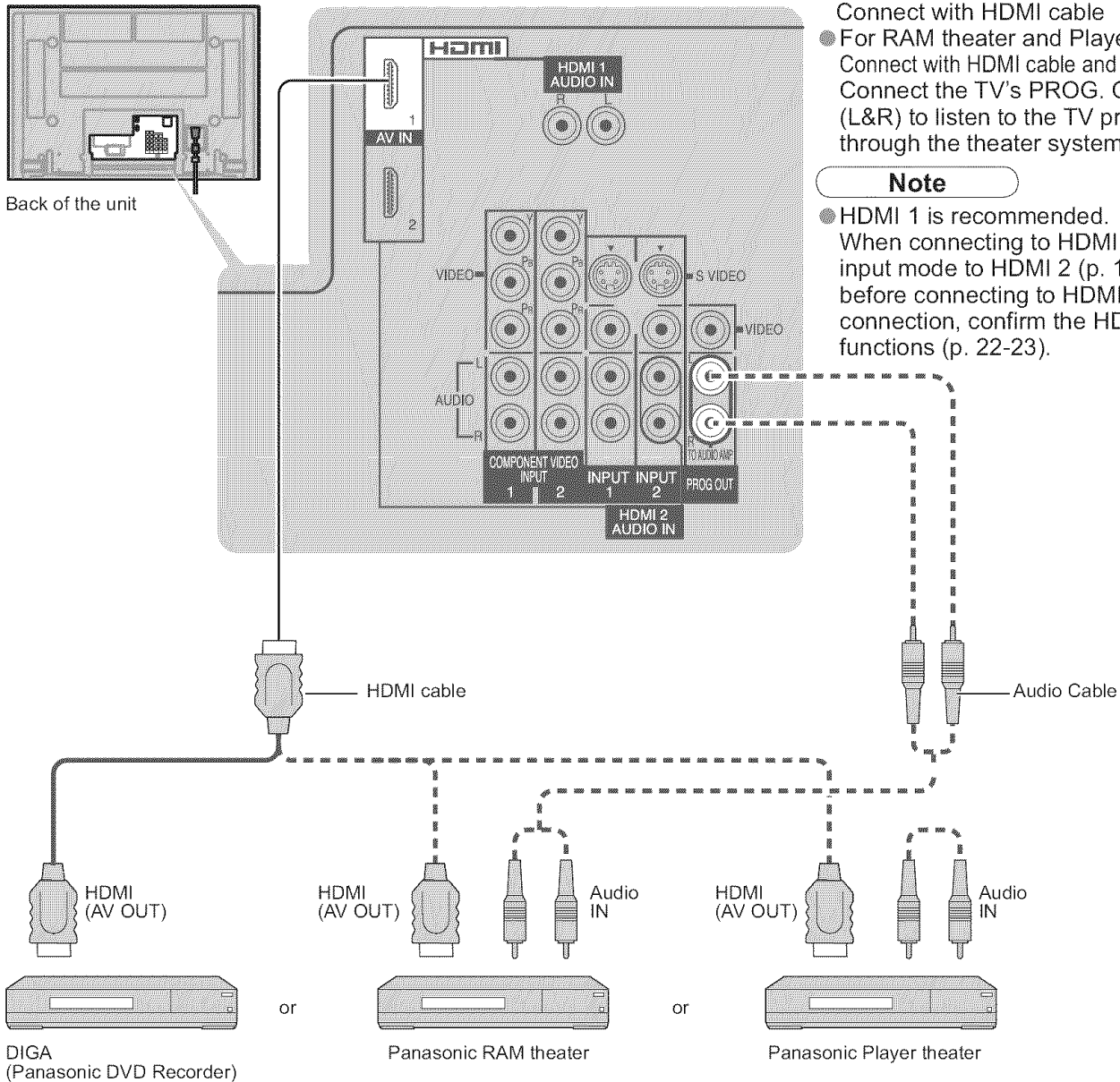

- For DIGA :
Connect with HDMI cable
- For RAM theater and Player theater :
Connect with HDMI cable and audio cable. Connect the TV's PROG. OUT audio (L&R) to listen to the TV program through the theater system.

Note

- HDMI 1 is recommended. When connecting to HDMI 2, set the input mode to HDMI 2 (p. 19) initially before connecting to HDMI 2. After connection, confirm the HDMI control functions (p. 22-23).

■ Setting of this unit after connection

After making connections as shown above, set “Ctrl with HDMI” (under “Other adjust”) to “On” using the Setup menu. (p. 22).

Note

- Individual HDMI equipment may require additional menu settings specific to each model. Please refer to their respective operating instruction manuals.

■ Connecting this unit to a DVD recorder and AV amp

When using an "Control with HDMI" audio-video amplifier and a compatible DIGA recorder, use a daisy chain connection as shown below.

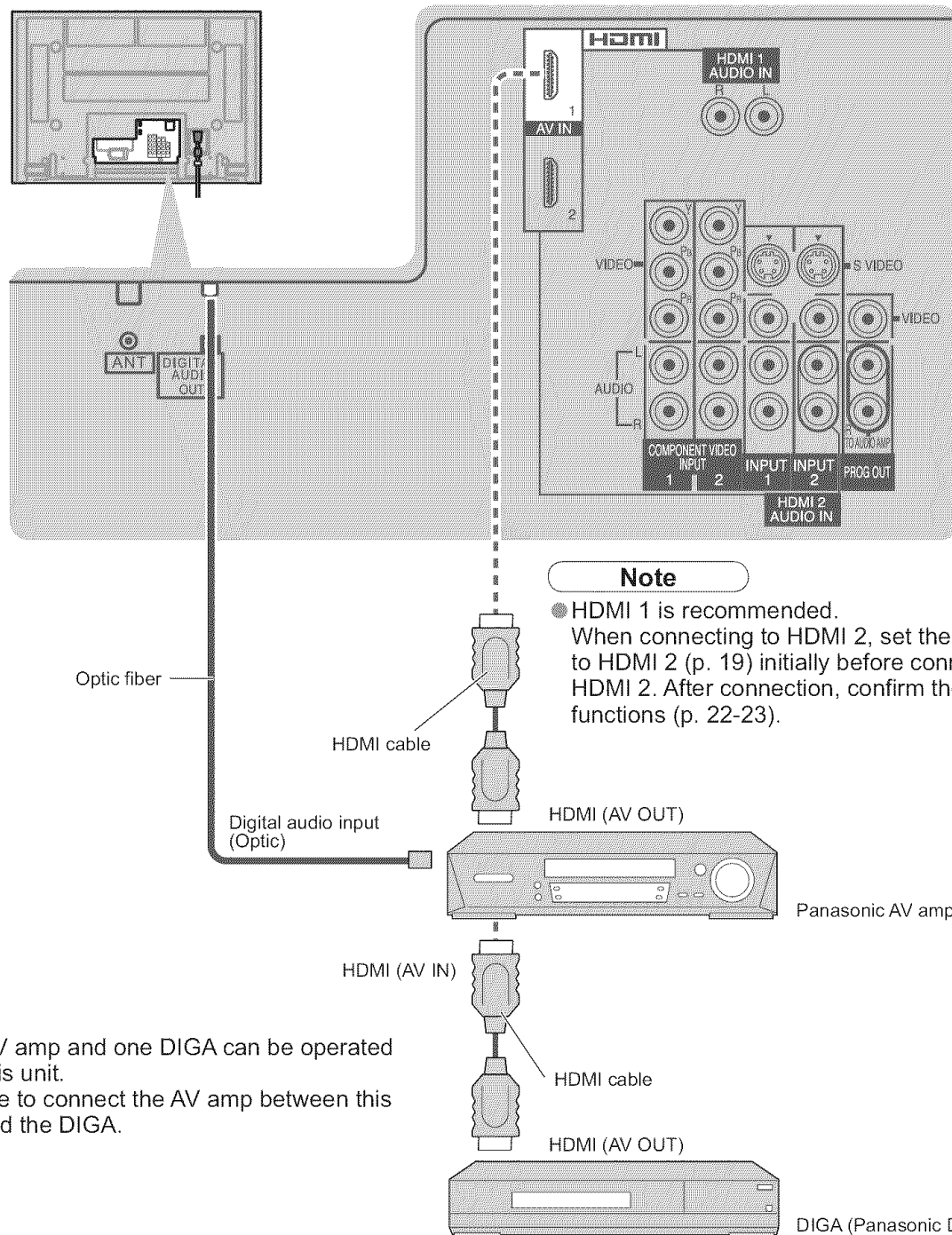

Note

- HDMI 1 is recommended. When connecting to HDMI 2, set the input mode to HDMI 2 (p. 19) initially before connecting to HDMI 2. After connection, confirm the HDMI control functions (p. 22-23).

- One AV amp and one DIGA can be operated with this unit.
- Be sure to connect the AV amp between this unit and the DIGA.

■ Setting of this unit after connection

After making connections as shown above, set "Ctrl with HDMI" (under "Other adjust") to "On" using the Setup menu. (p. 22).

Note

- Individual HDMI equipment may require additional menu settings specific to each model. Please refer to their respective operating instruction manuals.
- When audio from other equipment connected to this unit via HDMI is output using "DIGITAL AUDIO OUT" of this unit, the system switches to 2CH audio. (When connecting to an AV amp via HDMI, you can enjoy higher sound quality.)

Channel Lock

You can lock out specified channels or shows to prevent children from watching objectionable content.

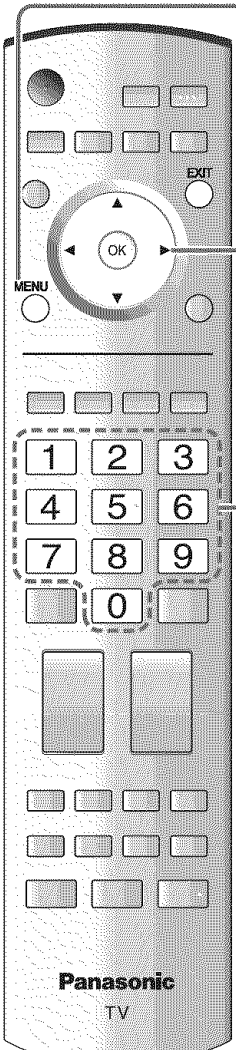

1 Display menu
MENU

2 Select "Lock"
You will be asked to enter your password each time you display the Lock menu.

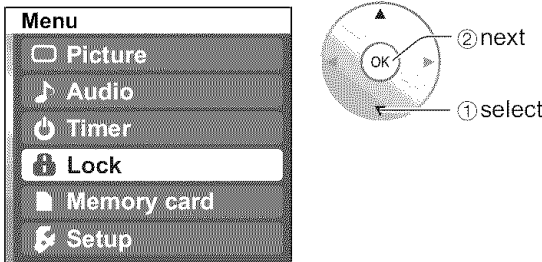

3 Input your 4-digit password
A 4-digit code must be entered to view a blocked program or change rating settings.

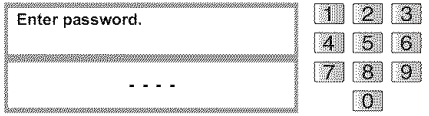

4 Select the Lock mode

■ Press to exit

EXIT



Caution

- Make a note of your password in case you forget it. (If you have forgotten your password, consult your local dealer.)

Note

- When you select a locked channel, a message will be displayed that allows you to view the channel if you input your password.

- Off: "Channel lock" not activated
- All: Locks all channels and Video inputs
- Game: Locks CH3, CH4, and Video inputs
- CH: Locks specified channels (analog/digital)

■ To change the password

- ① In ④, select "Change password" and press "OK" button
- ② Input the new 4-digit password twice

■ To cancel the "Channel lock"

- Select "Off" in ④

■ To select the channel or the rating of the program to be locked

Channel Lock

Select up to 7 (1-7) channels to be blocked out. These channels will be blocked out regardless of the program rating.

Select "CH" in ④ on p. 26

① Select "Channel"

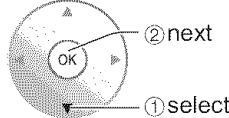
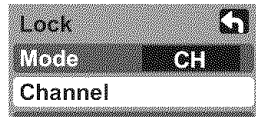

② Select channel to lock

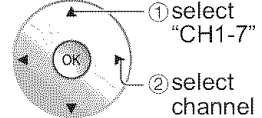
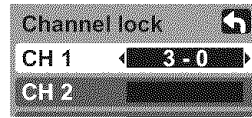

■ To set rating level

"V-chip" technology enables restricted shows to be locked according to TV ratings.

① Select "Program"

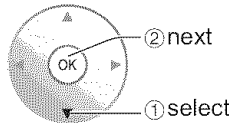
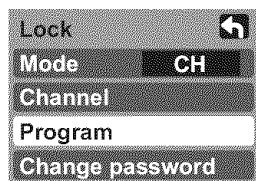

② Select the rating category you wish to follow

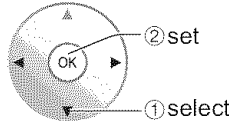
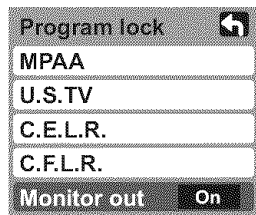

③ Select the rating to be locked

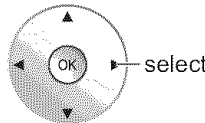

Example of "MPAA" (U.S movie ratings)

Off	No rating
G	General Audience: All ages admitted
PG	Parental Guidance Suggested
PG-13	Parents Strongly Cautioned: Inappropriate for children under 13
R	Restricted: Under 17 requires accompanying parent or adult guardian
NC-17	No one 17 and under admitted
X	Adults only

● To get other information (p. 39)

Block program

- MPAA : U.S movie ratings
- U.S.TV : U.S TV program ratings
- C.E.L.R. : Canadian English ratings
- C.F.L.R. : Canadian French ratings

■ To disable recording of the locked program

➔ Select "Monitor out" in "Program lock" menu (②)

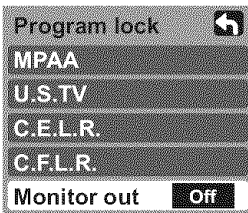

- On : Turns on the monitor terminal output for programs that have been set to "Blocked."
- Off : Turns off the monitor terminal output for programs that have been set to "Blocked."

Caution

- The V-Chip system that is used in this set is capable of blocking "NR" programs (non rated, not applicable and none) as per FCC Rules Section 15.120(e)(2). If the option of blocking "NR" programs is chosen "unexpected and possibly confusing results may occur, and you may not receive emergency bulletins or any of the following types of programming:"
 - Emergency Bulletins (Such as EAS messages, weather warnings and others)
 - Locally originated programming • News • Political • Public Service Announcements • Religious • Sports
 - Weather

Note

- The Off rating is independent of other ratings.
- When placing a block on a specific age based rating level, the Off rating and any other more restrictive ratings will also be blocked.

Editing and Setting Channels

The current channel settings can be changed according to your needs and reception conditions.

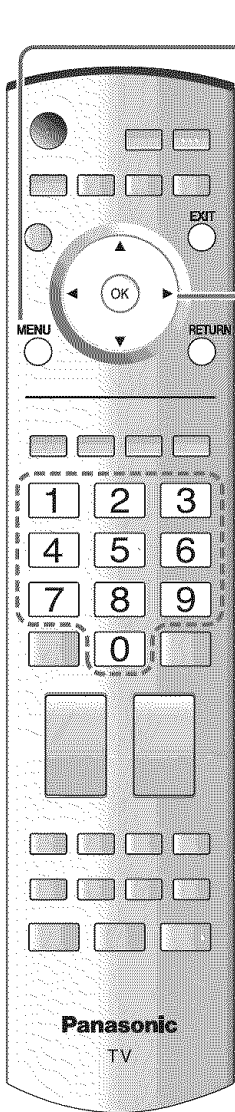

1 Display menu
MENU

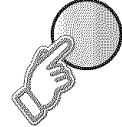

2 Select "Setup"

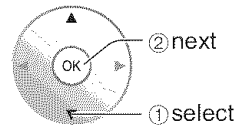
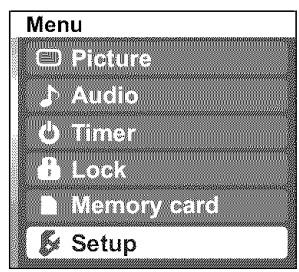

3 Select "Program channel"

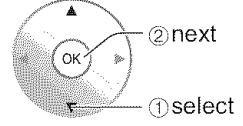
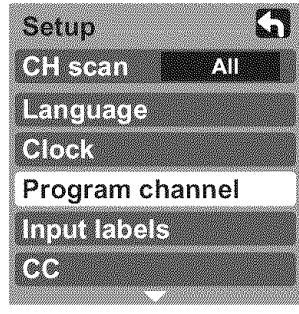

4 Select the function

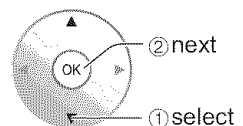
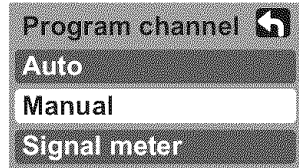

■ Press to exit
EXIT



5 Set

- To reset the settings of Setup menu
 - ① Select "Reset" in Setup menu (3) and press "OK" button
 - ② Input your 4-digit password with number buttons
 - ③ Select "Yes" on the confirmation screen and press "OK" button

Auto
Set automatically

Manual
Set manually

Signal meter
Check signal strength

Automatically searches and adds receivable channels to memory.

- ① Select "ANT In" → (Select Cable or Antenna)
- ② Select "Mode" → Select All or Analog
All: Analog and digital
Analog: Analog only

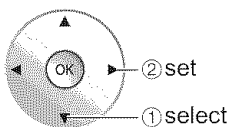
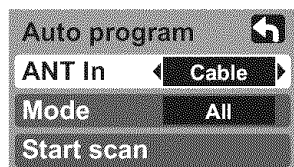

- ③ Select "Start scan"

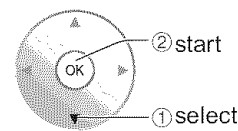
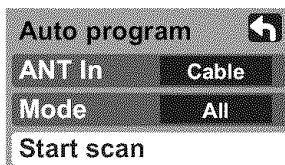

Settings are made automatically

- After completing the setting, select "Apply". (see below ④).
- All previous memorized channels are erased.

Use this procedure when changing setting of receiving channels or changing the channel display. Also, use to add or delete channels from channel list manually.

- ① Select "Edit"

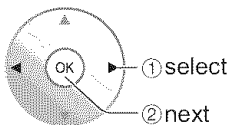
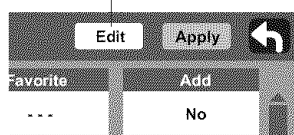

- ② Select the item to be edited

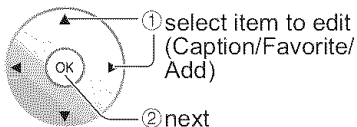
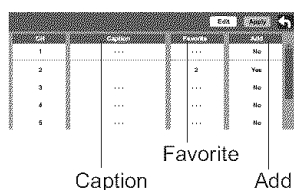

- Caption:
Changes the station identifier
- Favorite:
Registers channel to Favorites List
- Add:
Adds or deletes channels

- ③ Edit

- Caption

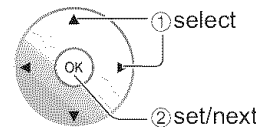
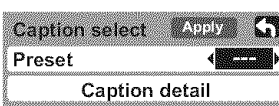

- Preset

Select the station identifier

- Caption detail

Rename (maximum 7 characters available)

- Favorite

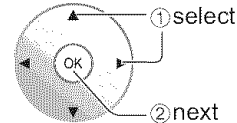

- Favorite

Select the number

- Add

- Press "OK" button to select "Yes (add)" or "No (delete)"

- ④ Select "Apply"

Press to move cursor to "Apply"

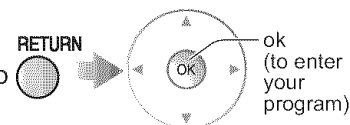

Check the signal strength if interference is found or freezing occurs on a digital image.

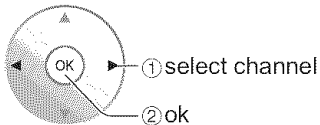
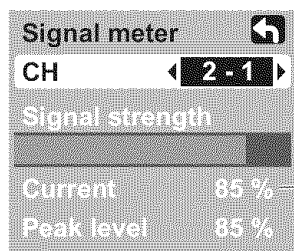

Signal intensity

- If the signal is weak, check the antenna. If no problem is found, consult your local dealer.

Note

- Not available if "Cable" is selected in "ANT In" (see above).
- Effective only for digital antenna channels.

- If "Channel lock" (p. 26) is activated and "Auto", "Manual" or "Signal meter" is selected, "Enter password." will be displayed.

Input Labels/Closed Caption

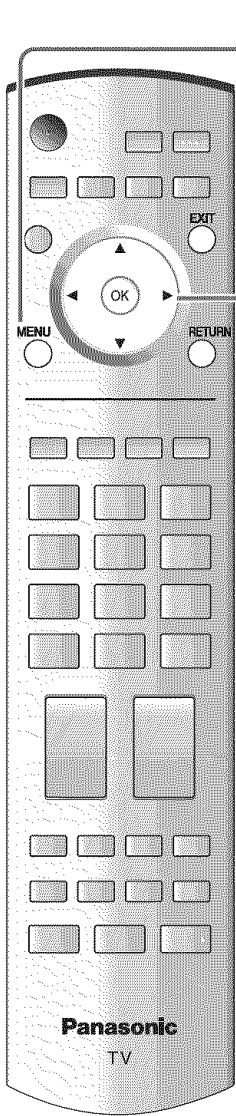

1 Display menu
MENU



2 Select "Setup"

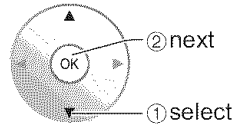
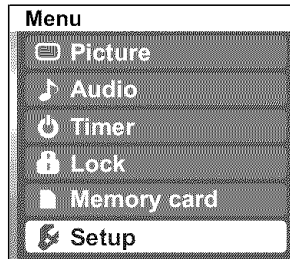

3 Select "Input labels" or "CC"

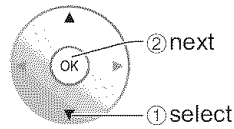
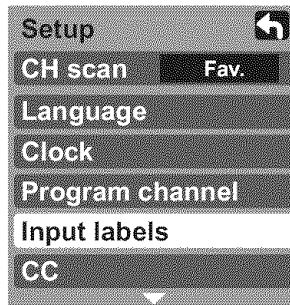

■ Press to exit



4 Set

Input labels

Display labels of external devices

CC

Display Closed Caption

The labels of devices connected to external input terminals can be indicated for easy recognition on the screen. (In selecting input mode of p. 19 ●)

Select the terminal and the label of the external equipment

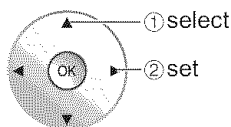
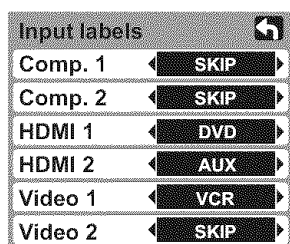

- Terminals: Comp.1-2/HDMI1-2/Video1-3
- Label: SKIP*/VCR/DVD/CABLE/DBS/PVR/GAME/AUX/[BLANK]

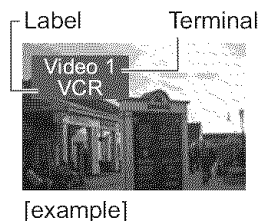

[example]

* If "SKIP" is selected for a non-connected terminal, its input is skipped when switched with TV/VIDEO button.



The television includes a built-in decoder that is capable of providing a visual display of the audio portion. The program viewed must provide Closed Captioning (CC) for the television to display it. (p. 40)

■ Select the item and set

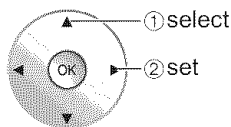
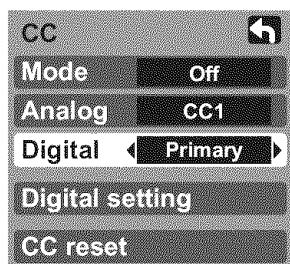

Mode

Select "On" (when not using, select "Off").

Analog

(Choose the closed caption service of Analog broadcasting.)

CC1-4: Information related to pictures (Appears at bottom of screen)

T1-4: Textual information (Appears over entire screen)

Digital

(The Digital Closed Caption menu lets you configure the way you choose to view the digital captioning.)

- The settings in "Analog" or "Digital" depend on the broadcaster.

Select the setting.

- "Primary", "Second.", "Service 3", "Service 4", "Service 5", "Service 6"

■ To make more in-depth display settings in digital programs

- ① Select "Digital setting" and press "OK" button
- ② Select the item and set

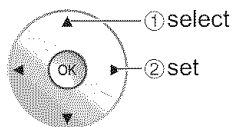
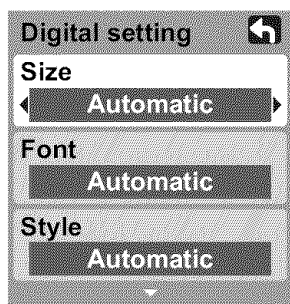

- Size: Text size
 - Font: Text font
 - Style: Text style (Raised, Depressed, etc.)
 - Foreground: Color of text
 - Fore opacity: Opacity of text
 - Background: Color of text box
 - Back opacity: Opacity of text box
 - Outline: Outline color of text
- (Identify the setting options on the screen.)

(1/3)

■ To reset the settings

Select "CC reset" and press "OK" button

Using Timer

The TV can automatically turn On/Off at the designated date and time.

● The Clock must be set before On time/Off time settings. (p. 13)

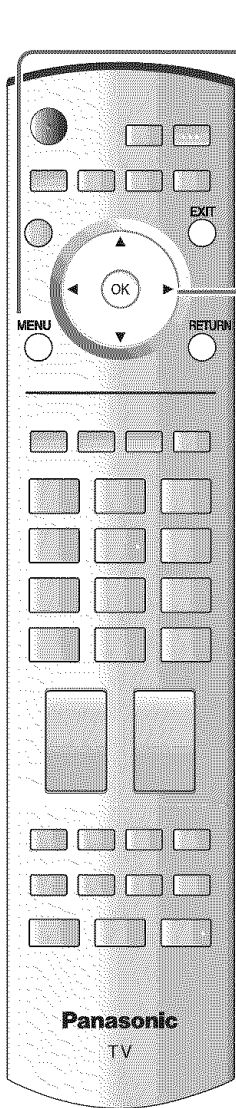

1 Display menu
MENU



2 Select "Timer"

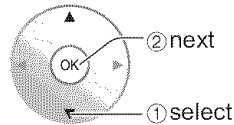
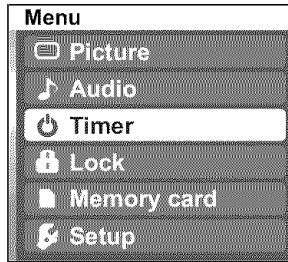

3 Select the timer to set

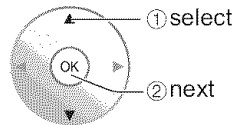
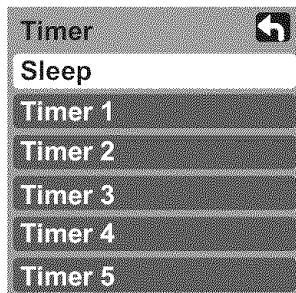

- Sleep** Turns Off automatically
- Timer 1** Turns On/Off automatically (5 timers can be set.)
- Timer 5**

4 Set the timer

■ To set "Sleep" (Off Timer)

Press to set unit to shut itself off after a preselected amount of time.

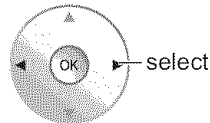

● 0/30/60/90 (minutes)

■ Press to exit



■ Press to return to the previous screen



Note

● The TV automatically turns Off after 90 minutes when turned On by the Timer. This operation will be cancelled if the Off time is selected or if a key is pressed.

■ To set "Timer 1-5" (On/Off Timer)

Select the item and set

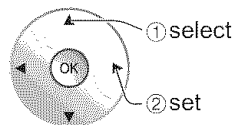
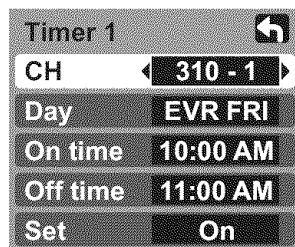

CH Select the channel

Day Select the day

(SUN/MON/TUE/WED/THU/FRI/SAT/
MON-FRI/SAT-SUN/DAILY/EVR SUN/
EVR MON/EVR TUE/EVR WED/EVR THU/
EVR FRI/ EVR SAT

On time The time to turn On

Off time The time to turn Off

Set Timer setting (On/Off)

Operating Peripheral Equipment

You can operate other manufacturers' components using this TV's remote control.

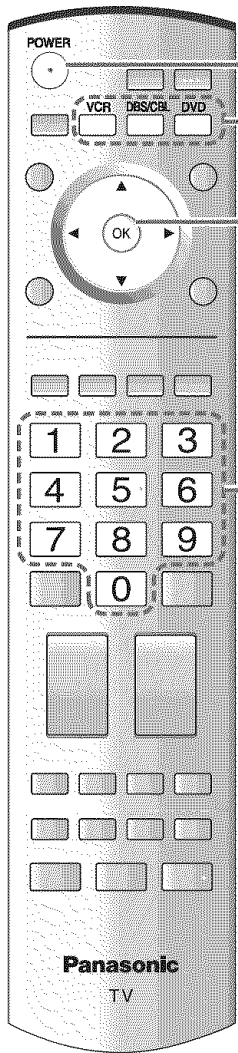

1 Connect the external equipment to the TV and **turn Off the external equipment**

2 Press both buttons simultaneously for more than 3 seconds.

- Release the buttons when the equipment selection buttons start flashing.

3 Select the equipment with the equipment selection button

with the equipment selection button

- The selected button remains lit (other buttons are not lit).

4 Input the equipment's 4-digit remote control code (p. 37-38)

5 Confirm the equipment with the remote control

- The external equipment turns On.

■ If the equipment does not operate with remote control

- When your equipment has a single code
 - ➔ Input the remote control code again
- When your equipment has multiple codes
 - ➔ Change the code with 4 above and test again (p. 37-38)

Caution

- Registration will fail if the wrong code is input or it takes more than 30 seconds to register.

To find a code not listed in the code list

This procedure searches all codes and is called the "sequence method."

① After step ③ above, change the code and test



➔ Operate the equipment with the remote control (p. 36)

- Repeat until the code is found
- It may take many attempts before the correct code is found

② When the correct code is found

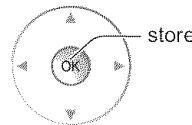

Recommended AV Connections

These diagrams show our recommendations for how to connect the TV unit to your various equipment. For other connections, consult the instructions of each equipment, and the specifications (p. 46-47). For additional assistance, please visit our website at : www.panasonic.com
www.panasonic.ca

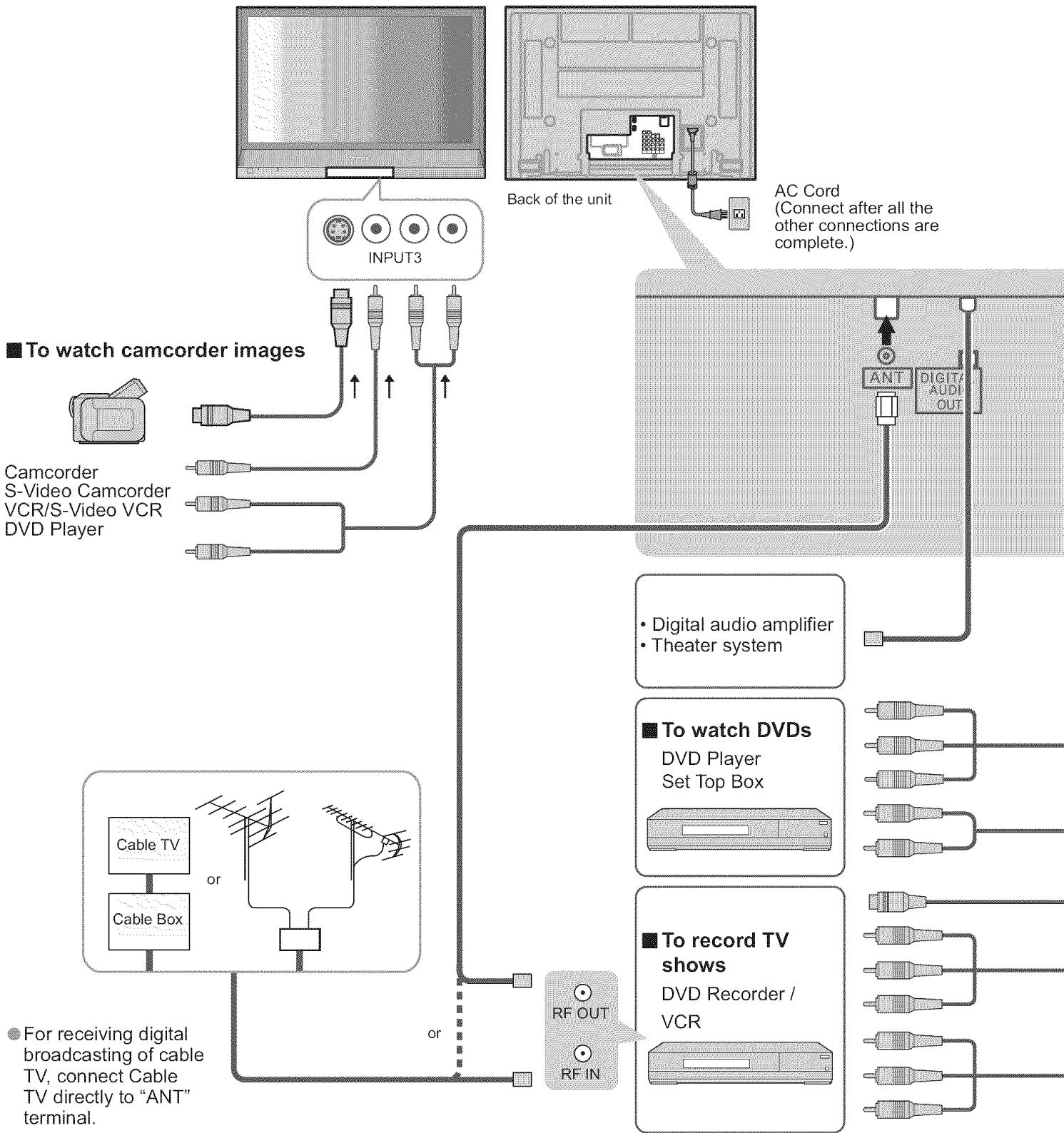

Caution

● For Antenna connection via VCR, please refer to the Operating Instructions of a VCR.

■ Recommended HDMI Connections (p. 24-25)

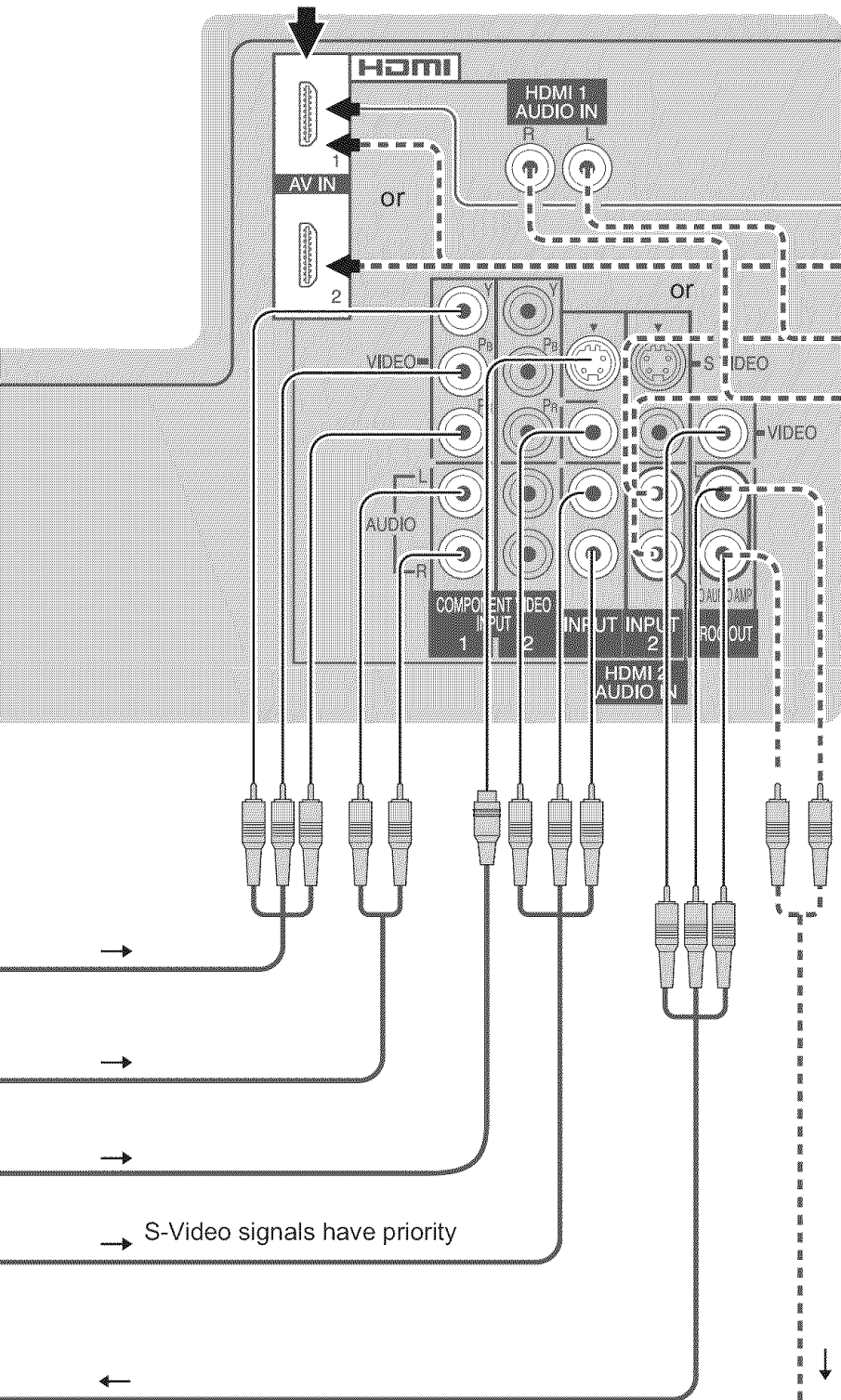

■ To watch digital video image

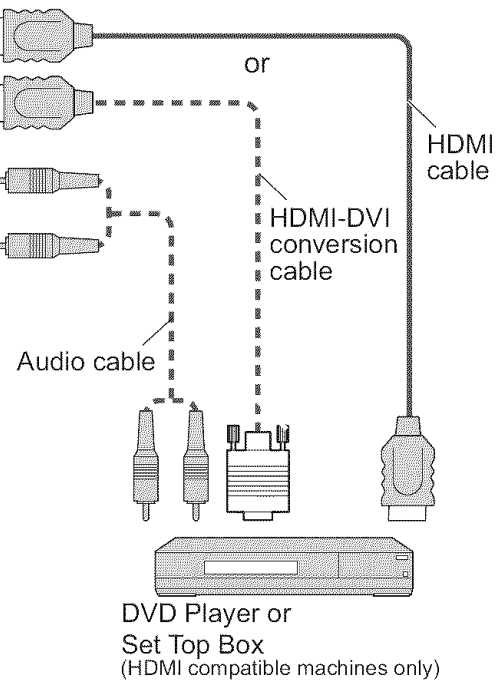

DVD Player or Set Top Box (HDMI compatible machines only)

Note

- The picture and audio input signals connected to a terminal specified in "Prog-out stop" (p. 20) cannot be output from "OUTPUT" terminals. However, audio output can be obtained from the optical Digital Audio Out terminal.
- To prevent howling and image oscillation, set the "Prog-out-stop" setting when connecting VCR with loop-connection. (p. 20)
- When a device (STB, DVD, etc.) is connected to the HDMI or COMPONENT terminals, only audio signals will be output. No video signals will be output.

■ To listen to the TV through speakers

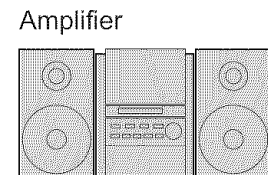

- Turn Off the TV speakers. (p. 20 "Speakers")

Remote Control Operation/Code List

The following explains how to operate external devices with the remote control.

- Register the remote control codes (p. 33) if you want to operate an external device of another manufacturer. (p. 37-38)

Note

- Operation may not be possible depending on the available memory size of the remote control. This remote control is not designed to cover operation of all functions of all models.

Remote Control Operation List

This chart defines which keys are operational after programming (if needed), while in the selected remote control mode, VCR, DBS/CBL, DVD.

KEY NAME	VCR MODE	DBS/CBL MODE		DVD MODE
		(DBS)	(CBL)	
POWER	Power	Power	Power	Power
TV/VIDEO	TV Input Switch	TV Input Switch	TV Input Switch	TV Input Switch
EXIT	—	Exit	Exit	—
	—	DBS Cursor Up/Down/Right/Left	CBL Cursor Up/Down/Right/Left	DVD Cursor Up/Down/Right/Left
	—	Ok	Ok	Ok
MENU	—	DBS Menu	CBL Menu	DVD Setup Menu
RETURN	—	—	—	Return, Clear
MUTE	TV Mute	TV Mute	TV Mute	TV Mute
ASPECT	—	Aspect	Aspect	DVD Disc Menu
FAVORITE	—	—	—	Title
RECALL	Onscreen Display	Onscreen Display	Onscreen Display	Onscreen Display
0 ~ 9	0-9	0-9	0-9	0-9
R-TUNE	—	DBS Previous Channel	CBL Previous Channel	Drive Select
	Channel Up/Down	DBS Channel Up/Down	CBL Channel Up/Down	Channel Up/Down
	TV Volume Up/Down	TV Volume Up/Down	TV Volume Up/Down	TV Volume Up/Down
SLEEP	—	Sleep	Sleep	—
TV/VCR	TV/VCR Switch	TV/DBS Switch	TV/CBL Switch	—
REC	VCR Record	PVR Record *1	PVR Record *1	Record
OPEN/CLOSE	—	Search *1	Search *1	Open/Close
SKIP	—	—	—	Skip Reverse/Forward
SEARCH	Reverse/Forward	—	—	Rewind/Fast Forward
STOP	Stop	—	—	Stop
PAUSE	Pause	—	—	Pause
PLAY	Play	—	—	Play

*1: Combination type

Remote Control Code List

Cable Converter (DBS/CBL)

Brand	Code	Brand	Code	Brand	Code	Brand	Code
ABC	0003, 0008	Hamlin	0009, 0273	Philips	0317, 1305	Scientific Atlanta	0008, 0477, 0877, 1877
Americast	0899	Jerrold	0003, 0276, 0476, 0810	Pioneer	0144, 0533, 0877, 1877	Sony	1006
Bell South	0899	Memorex	0000	Pulsar	0000	Starcom	0003
Digeo	1187	Motorola	1376, 0276, 0476, 0810, 1187	Quasar	0000	Supercable	0276
Director	0476	Pace	0008, 0237, 1877	Regal	0273, 0279	Torx	0003
General Instrument	0003, 0276, 0476, 0810	Panasonic	0000, 0107	Runco	0000	Toshiba	0000
GoldStar	0144	Paragon	0000	Samsung	0144	Zenith	0000, 0525, 0899

Satellite Receiver (DBS/CBL)

AlphaStar	0772	General Instrument	0869	Magnavox	0722, 0724	Samsung	1108, 1109, 1142, 1276, 1377, 1442, 1609
Chaparral	0216	GOI	0775, 1775	Memorex	0724	Sanyo	1219
Crossdigital	1109	Goodmans	1246	Mitsubishi	0749	Sony	0639, 1639, 1640
DirecTV	0099, 0247, 0392, 0566, 0639, 0724, 0749, 0819, 1076, 1108, 1109, 1142, 1377, 1392, 1414, 1442, 1443, 1444, 1609, 1639, 1640, 1749, 1856	Hisense	1535	NEC	1270	Star Choice	0869
Dish Network System	0775, 1005, 1170, 1505, 1775	HITACHI	0819, 1250	Next Level	0869	Tivo	1142, 1442, 1443, 1444
Dishpro	0775, 1005, 1505, 1775	HTS	0775, 1775	Panasonic	0152, 0247, 0701, 1786	Toshiba	0749, 0790, 0819, 1285, 1749
Echostar	0775, 1005, 1170, 1505, 1775	Hughes	0749, 1442, 1749	Paysat	0724	UltimateTV	1392, 1640
Expressvu	0775, 1775	Hughes Network Systems	0749, 1142, 1442, 1443, 1444, 1749	Philips	0099, 0722, 0724, 0749, 0819, 1076, 1142, 1442, 1749	Uniden	0722, 0724
GE	0392, 0566	iLo	1535	Pioneer	1442	US Digital	1535
		Janel	0152	Proscan	0392, 0566	Voom	0869
		Jerrold	0869	Proton	1535	Zenith	1856
		JVC	0775, 1170, 1775	RadioShack	0869		
		LG	1226, 1414	RCA	0143, 0392, 0566, 0855, 1392		

Cable/PVR Combination (DBS/CBL)

Americast	0899	Jerrold	0476, 0810	Pioneer	0877, 1877	Supercable	0276
Digeo	1187	Motorola	0476, 0810, 1187, 1376	Scientific Atlanta	0877, 1877	Zenith	0899
General Instrument	0476, 0810	Pace	0237, 1877	Sony	1006		

DBS/PVR Combination (DBS/CBL)

DirecTV	0099, 0392, 0639, 1076, 1142, 1377, 1392, 1442, 1443, 1444, 1640	Dishpro	0775, 1505	JVC	1170	Samsung	1442
Dish Network System	0775, 1505	Echostar	0775, 1170, 1505	Motorola	0869	Sony	0639, 1640
		Expressvu	0775	Philips	1142, 1442	Star Choice	0869
		Hughes Network Systems	1142, 1442, 1443, 1444	Proscan	0392		
				RCA	1392		

VCR (VCR)

ABS	1972	Hewlett Packard	1972	NEC	0067	Scott	0043, 0045
Adventura	0000	Hitachi	0000, 0042, 0089	Nikko	0037	Sears	0000, 0035, 0037, 0042, 1237
Aiwa	0000, 0037, 0124	Howard Computers	1972	Niveus Media	1972	Sharp	0807, 0848
Akai	0175	HP	1972	Northgate	1972	Sonic Blue	0614, 0616
Alienware	1972	Hughes Network Systems	0042, 0739	Olympus	0035, 0226	Sony	0000, 0032, 0033, 0035, 0636, 1032, 1232, 1972
American High	0035	Humax	0739	Onkyo	0222	Stack 9	1972
Audiovox	0037	Hush	1972	Optimus	0037	STS	0042
Broksonic	1479	iBUYPOWER	1972	Orion	1479	Sylvania	0000, 0035, 0043, 1781
Calix	0037	JVC	0067	Panasonic	0035, 0077, 0225, 0226, 0227, 0378, 0616, 1035, 1244	Symphonic	0000
Canon	0035	KEC	0037	Penney	0035, 0037, 0042, 1035, 1237	Systemax	1972
Citizen	0037, 1278	Kenwood	0067	Pentax	0042	Tagar Systems	1972
Craig	0037	Kodak	0035, 0037	Philco	0035	Teac	0000
Curtis Mathes	0035, 0060, 1035	Linksys	1972	Philips	0035, 0618, 0739, 1081, 1181	Technics	0035
CyberPower	1972	Lloyd's	0000	Pilot	0037	Teknika	0000, 0035, 0037
Daewoo	0045, 1278	LXI	0037	Pioneer	0067	Thomas	0000
Dell	1972	Magnasonic	1278	Proscan	0060, 1060	Tivo	0618, 0636, 0739
Denon	0042	Magnavox	0000, 0035, 0039, 1781	Pulsar	0039	Toshiba	0043, 0045, 0845, 1008, 1145, 1972
DirecTV	0739	Marantz	0035	Quasar	0035, 0077, 1035	Totevision	0037
Durabrand	0039	Marta	0037	RadioShack	0000	Touch	1972
Dynatech	0000	Matsushita	0035	Radix	0037	Vector	0045
Electrohome	0037, 0043	Media Center PC	1972	Randex	0037	Video Concepts	0045
Electrohome	0037	MEI	0035	RCA	0042, 0060, 0077, 0807, 0880, 1035, 1060	Videomagic	0037
Emerex	0032	Memorex	0000, 0035, 0037, 0039, 1237	Realistic	0000, 0035, 0037	Viewsonic	1972
Emerson	0000, 0037, 0043, 1278, 1479	MGA	0043	ReplayTV	0614, 0616	Villain	0000
Fuji	0033, 0035	Microsoft	1972	Ricavision	1972	Voodoo	1972
Funai	0000	Mind	1972	Runco	0039	Wards	0000, 0035, 0042, 0060
Garrard	0000	Minolta	0042	Samsung	0045, 0739, 1014	XR-1000	0000, 0035
Gateway	1972	Mitsubishi	0043, 0067, 0807	Sanyo	0039	Zenith	0000, 0033, 0039, 1479
GE	0035, 0060, 0807, 1035, 1060	Motorola	0035	Sansui	0000, 0067, 1479	ZT Group	1972
GoldStar	0037, 1237	MTC	0000	Sanyo	0159		
Gradiente	0000	Multitech	0000				
Harley Davidson	0000						

Remote Control Operation/Code List

Remote Control Code List

DBS/PVR Combination (VCR)

Brand	Code	Brand	Code	Brand	Code	Brand	Code
Hughes Network Systems	0739	Philips	0739				
		Samsung	0739				

PVR (VCR)

ABS	1972	Hughes Network Systems	0739	Niveus Media	1972	Systemax	1972
Alienware	1972	Humax	0739	Northgate	1972	Tagar Systems	1972
CyberPower	1972	Hush	1972	Panasonic	0616		
Dell	1972	iBUYPOWER	1972	Philips	0618, 0739	Tivo	0618, 0636, 0739
DirectTV	0739	Linksys	1972	RCA	0880	Toshiba	1008, 1972
Gateway	1972	Media Center PC	1972	ReplayTV	0614, 0616	Touch	1972
Hewlett Packard	1972	Microsoft	1972	Sonic Blue	0614, 0616	Viewsonic	1972
Howard Computers	1972	Mind	1972	Sony	0636, 1972	Voodoo	1972
HP	1972			Stack 9	1972	ZT Group	1972

DVD (DVD)

Adcom	1094	GoldStar	0741	Onkyo	0503, 0792	Sensory Science	1158
Allegro	0869	Gradiente	0490	Panasonic	0490, 0503, 0632, 0703, 1010, 1011, 1362, 1462, 1490, 1762, 1967	Sharp	0630, 0675, 0752, 1256
Apex Digital	0672, 0794, 0796, 0797, 1004, 1056, 1061, 1100	Grundig	0539			Shinsonic	0533
		Hitachi	0573, 0664	Sonic Blue	0869		
Aspire Digital	1168	Hiteker	0672	Philips	0503, 0539, 0646, 0675, 1267, 1354	Sony	0533, 0864, 1033, 1431, 1533
		Integra	0571			Sylvania	0675
Blue Parade	0571	JVC	0558, 0623, 0867, 1164, 1275	PianoDisc	1024	Symphonic	0675
Broksonic	0695	Kenwood	0490, 0534	Pioneer	0525, 0571, 0631, 0632	Teac	0809
California Audio Labs	0490	Lecson	1533	Polaroid	1061, 1086	Technics	0490, 0703
CineVision	0833, 0869	LG	0591, 0741, 0801, 0869	Polk Audio	0539	Theta Digital	0571
Coby	1086	LiteOn	1158, 1440	Proceed	0672	Toshiba	0503, 0695, 1045, 1154
CyberHome	0816, 1023, 1024, 1129	Loewe	0511	Proscan	0522	Urban Concepts	0503
Daewoo	0833, 0869	Magnavox	0503, 0539, 0646, 0675	RCA	0522, 0571, 0822	Xbox	0522
Denon	0490	Marantz	0539	Rio	0869	Yamaha	0490, 0539, 0545
Disney	0675	McIntosh	1533	Rotel	0623	Zenith	0503, 0591, 0741, 0869
DVD2000	0521	Memorex	0695	Sampo	0752		
Emerson	0591, 0675	Microsoft	0522	Samsung	0490, 0573, 0820, 1075		
Enterprise	0591	Mitsubishi	0521, 1521	Sansui	0695		
Funai	0675	NAD	0591, 0741	Sanyo	0695, 0873, 1967		
Gateway	1158	NEC	0785				
GE	0522						
Go Video	0741, 0833, 0869, 1075, 1158, 1304, 1730						

DVD Recorder (DVD)

Apex Digital	1056	Go Video	0741, 1158, 1304, 1730	Philips	0646	Sensory Science	1158
Aspire Digital	1168	JVC	1164, 1275	Pioneer	0631	Sharp	0675
Coby	1086	LG	0741	Polaroid	1086	Sony	1033, 1431
CyberHome	1129	LiteOn	1158, 1440	RCA	0522	Sylvania	0675
Funai	0675	Magnavox	0646	Samsung	0490	Zenith	0741
Gateway	1158	Panasonic	0490, 1010, 1011				

Ratings List for Channel Lock

"V-chip" technology enables you to lock out channels or shows according to standard ratings set by the entertainment industry. (p. 27)

U.S. MOVIE RATINGS (MPAA)

Off	NO RATING (NOT RATED) AND NA (NOT APPLICABLE) PROGRAMS. Movie has not been rated or rating does not apply.
G	GENERAL AUDIENCES. All ages admitted.
PG	PARENTAL GUIDANCE SUGGESTED. Some material may not be suitable for children.
PG-13	PARENTS STRONGLY CAUTIONED. Some material may be inappropriate for children under 13.
R	RESTRICTED. Under 17 requires accompanying parent or adult guardian.
NC-17	NO ONE 17 AND UNDER ADMITTED.
X	ADULTS ONLY.

U.S. TV PROGRAMS RATINGS (U. S. TV)

Age-based Group	Age-based Ratings	Possible Content Selections	Description
NR (Not Rated)	TV-NR	<input type="radio"/> Viewable <input type="radio"/> Blocked	Not Rated.
Youth	TV-Y	<input type="radio"/> Viewable <input type="radio"/> Blocked	All children. The themes and elements in this program are specifically designed for a very young audience, including children from ages 2-6.
	TV-Y7	<input type="radio"/> FV Blocked <input type="radio"/> Viewable <input type="radio"/> Blocked	Directed to older children. Themes and elements in this program may include mild physical or comedic violence, or may frighten children under the age of 7.
Guidance	TV-G	<input type="radio"/> Viewable <input type="radio"/> Blocked	General audience. It contains little or no violence, no strong language, and little or no sexual dialogue or situations.
	TV-PG	<input type="radio"/> D,L,S,V (all selected) <input type="radio"/> Any combination of D, L, S, V	Parental guidance suggested. The program may contain infrequent coarse language, limited violence, some suggestive sexual dialogue and situations.
	TV-14	<input type="radio"/> D,L,S,V (all selected) <input type="radio"/> Any combination of D, L, S, V	Parents strongly cautioned. This program may contain sophisticated themes, sexual content, strong language and more intense violence.
	TV-MA	<input type="radio"/> D,L,S,V (all selected) <input type="radio"/> Any combination of L, S, V	Mature audiences only. This program may contain mature themes, profane language, graphic violence, and explicit sexual content.

FV: Fantasy/Cartoon Violence. V: Violence S: Sex L: Offensive Language D: Dialogue with sexual content.

CANADIAN ENGLISH RATINGS (C. E. L. R)

E	Exempt - Exempt programming includes: news, sports, documentaries and other information programming, talk shows, music videos, and variety programming.
C	Programming intended for children under age 8. No offensive language, nudity or sexual content.
C8+	Programming generally considered acceptable for children 8 years and over. No profanity, nudity or sexual content.
G	General programming, suitable for all audiences.
PG	Parental Guidance suggested. Some material may not be suitable for children.
14+	Programming contains themes or content which may not be suitable for viewers under the age of 14. Parents are strongly cautioned to exercise discretion in permitting viewing by pre-teens and early teens.
18+	18+ years old. Programming restricted to adults. Contains constant violence or scenes of extreme violence.

CANADIAN FRENCH RATINGS (C. F. L. R)

E	Exempt - Exempt programming.
G	General - Programming intended for audience of all ages. Contains no violence, or the violence content is minimal or is depicted appropriately.
8 ans+	8+ General - Not recommended for young children. Programming intended for a broad audience but contains light or occasional violence. Adult supervision recommended.
13 ans+	Programming may not be suitable for children under the age of 13 - Contains either a few violent scenes or one or more sufficiently violent scenes to affect them. Adult supervision strongly suggested.
16 ans+	Programming may not be suitable for children under the age of 16 - Contains frequent scenes of violence or intense violence.
18 ans+	Programming restricted to adults. Contains constant violence or scenes of extreme violence.

Technical Information

Closed Caption (CC)

- For viewing Closed Caption of digital broadcasting, set the aspect ratio to FULL.
(If viewing with H-FILL, JUST, ZOOM or 4:3, characters will be cut off.)
- The closed caption is not displayed when you use HDMI connection.
- If analog connected equipment is used for displaying or recording, closed caption (CC) should be set On/Off on the connected equipment.
The CC mode setting of the TV will not affect the analog input.
If a digital program is being output in analog format, the CC data will also be output in analog format.
If digital connected equipment is used for input, CC should be set to On on either the connected equipment or the TV.
If CC is set On on both the connected equipment and the TV, captions from each unit will overlap.

Aspect Ratio

Let you choose the aspect depending on the format of the received signal and your preference. (p. 15)

● FULL

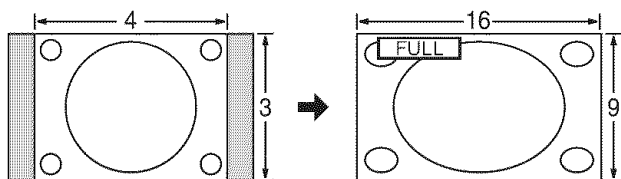

Enlarges the 4:3 image horizontally to the screen's side edges.
(Recommended for anamorphic picture)

● JUST

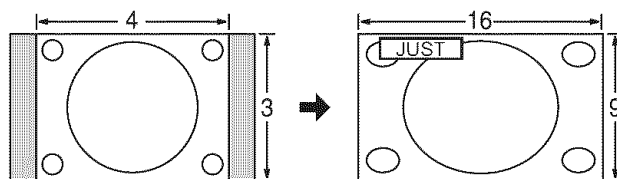

Stretches to justify the 4:3 image to the four corners of the screen.
(Recommended for normal TV broadcast)

● H-FILL

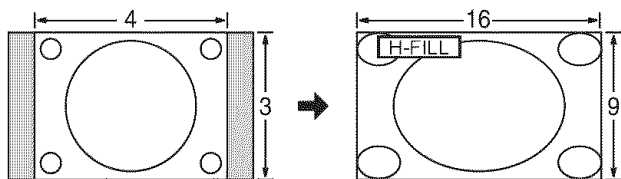

Enlarges the 4:3 image horizontally to the screen's side edges. The side edges of the image are cut off.

● 4:3

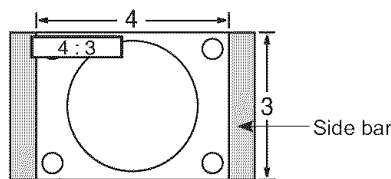

Standard
(Note that "after image" of the side bar may occur from displaying it for a long time.)

● ZOOM

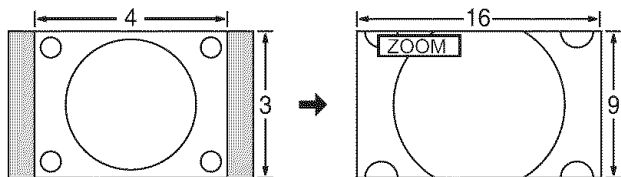

Enlarges the 4:3 image to the entire screen.
(Recommended for Letter Box)

Note

- 480i (4:3), 480i (16:9), 480p (4:3), 480p (16:9) : FULL, JUST, 4:3 or ZOOM
- 1080p / 1080i / 720p : FULL, H-FILL, JUST, 4:3 or ZOOM.
- When the signal is 720p/1080i/1080p, the aspect mode automatically defaults to Full after turning off the TV, after changing input mode, or after changed signal resolution other than 720p/1080i/1080p.

● Zoom adjust

Vertical image position and size can be adjusted in "ZOOM."

- ① Select "Zoom adjust" on the Picture menu. (p. 20)
- ② Vertical position adjustment

Vertical size adjustment

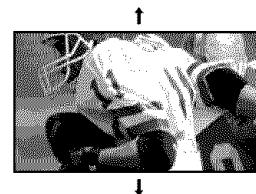

- To reset the aspect ratio →  (OK)

Data format for Card browsing

Photo:	Still images recorded with digital still cameras compatible with JPEG files of DCF* and EXIF standards
Data format:	Baseline JPEG 160X120-2,560X1,920 pixels (Sub-sampling: 4:4:4, 4:4:2 or 4:2:0)
Max. number of files:	9,999
Image resolution:	8 x 8 to 5,120 x 3,840

* DCF (Design rule for camera file system): A Japan Electronics and Information Technology Industries Association's standard

Caution

- A JPEG image modified with a PC cannot be displayed.
- Partly degraded files might be displayed at a reduced resolution.

Note

- Folder structure viewed in PC

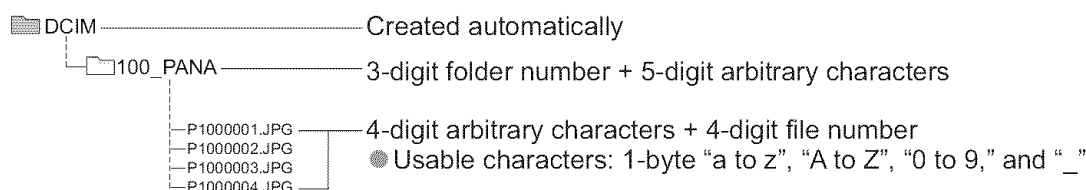

- The folder and file names may be different depending on the digital camera used.
- Suitable SD Memory Cards. Please confirm the latest information on the following website.
<http://panasonic.co.jp/pavc/global/cs> (This site is in English only)

DIGITAL AUDIO OUT terminals

You can enjoy your home theater by connecting a Dolby Digital (5.1 channel) decoder and "Multi Channel" amplifier to the DIGITAL AUDIO OUT terminals.

Caution

- External speakers cannot be connected directly to PROG.OUT terminals.
- When ATSC channel is selected, the output from the DIGITAL AUDIO OUT jack will be Dolby Digital. When NTSC channel is selected, the output will be PCM.

Control with HDMI "HDAVI Control"

HDMI connections to some Panasonic equipment allow you to enjoy the easy playback or home theater.

- Setup the equipment to enable this function. Read the manual of the equipment.
- Switch the TV unit on again with the equipment on when connection or setup is changed.
- This function may not work normally depending on the equipment condition.
- The equipment can be operated by TV's remote control with this function on even if TV is in Standby mode.
- Image or sound may not be available for the first few seconds when the playback starts.
- Image or sound may not be available for the first few seconds when Input mode is switched.
- Volume function will be displayed when adjusting the volume of the equipment.
- Easy playback is also available by using the remote control for Amplifier. Read the manuals of Amplifier.

Technical Information

HDMI connection

HDMI (high-definition multimedia interface) allows you to enjoy high-definition digital images and high-quality sound by connecting the TV unit and the devices.

HDMI-compatible equipment (*1) with an HDMI or DVI output terminal, such as a set top box or a DVD player, can be connected to the HDMI terminal using an HDMI compliant (fully wired) cable.

- HDMI is the world's first complete digital consumer AV interface complying with a non-compression standard.
- If the external device has only a DVI output, connect to the HDMI terminal via a DVI to HDMI adapter cable (*2).
- When the DVI to HDMI adapter cable is used, connect the audio cable to the audio input terminal.
- Audio settings can be made on the "HDMI1 in" or "HDMI2 in" menu screen. (p. 20)
Applicable audio signal sampling frequencies (L.PCM): 48 kHz, 44.1 kHz, 32 kHz

(*1): The HDMI logo is displayed on an HDMI-compliant device.
(*2): Enquire at your local digital device retailer shop.

Caution

- Use with a PC is not assumed.
- All signals are reformatted before being displayed on the screen.
- If the connected device has an aspect adjustment function, set the aspect ratio to "16:9".
- This HDMI connector is "type A".
- A device having no digital output terminal may be connected to the input terminal of either "COMPONENT", "S VIDEO", or "VIDEO" to receive analog signals.
- The HDMI input terminal can be used with only the following image signals: 480i, 480p, 720p, 1080i and 1080p. Match the output setting of the digital device.
- For details of the applicable HDMI signals, see below.

Input signal that can be displayed

* Mark: Applicable input signal for Component (Y, P_B, P_R), and HDMI

	horizontal frequency (kHz)	vertical frequency (Hz)	COMPONENT	HDMI
525 (480) / 60i	15.73	59.94	*	*
525 (480) / 60p	31.47	59.94	*	*
750 (720) / 60p	45.00	59.94	*	*
1,125 (1,080) / 60i	33.75	59.94	*	*
1,125 (1,080) / 60p	67.43	59.94		*
1,125 (1,080) / 60p	67.50	60.00		*

Note

- Signals other than those shown above may not be displayed properly.
- The above signals are reformatted for optimal viewing on your display.

Side Bar

Do not display a picture in 4:3 mode for an extended period, as this can cause an after-image to remain on either or both sides of the display field.

To reduce the risk of such an after-image, change the brightness of the side bars.

- The side bar may flash (alternate black/white) depending on the picture. Using Cinema mode will reduce such flashing (See below).

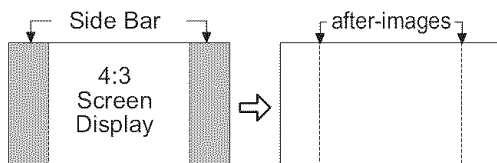

Pic. mode

- Vivid (default) : Provides enhanced picture contrast and sharpness for viewing in a well-lit room.
- Standard : Recommended for normal viewing conditions with subdued room lighting.
- Cinema : For watching movies in a darkened room. It provides a soft, film-like picture.

Maintenance

First, unplug the AC cord plug from the wall outlet.

Display panel

The front of the display panel has been specially treated. Wipe the panel surface gently using only a cleaning cloth or a soft, lint-free cloth.

- If the surface is particularly dirty, soak a soft, lint-free cloth in a weak detergent solution and then wring the cloth to remove excess liquid. Use this cloth to wipe the surface of the display panel, then wipe it evenly with a dry cloth, of the same type, until the surface is dry.
- Do not scratch or hit the surface of the panel with fingernails or other hard objects. Furthermore, avoid contact with volatile substances such as insect sprays, solvents and thinner; otherwise, the quality of the surface may be adversely affected.

Cabinet

If the cabinet becomes dirty, wipe it with a soft, dry cloth.

- If the cabinet is particularly dirty, soak the cloth in a weak detergent solution and then wring the cloth dry. Use this cloth to wipe the cabinet, and then wipe it dry with a dry cloth.
- Do not allow any detergent to come into direct contact with the surface of the Plasma TV. If water droplets get inside the unit, operating problems may result.
- Avoid contact with volatile substances such as insect sprays, solvents and thinner; otherwise, the quality of the cabinet surface may be adversely affected or the coating may peel off. Furthermore, do not leave it for long periods in contact with articles made from rubber or PVC.

Pedestal

● Cleaning

Wipe the surfaces with a soft, dry cloth. If the unit is particularly dirty, clean it using a cloth soaked with water to which a small amount of neutral detergent has been added, and then wipe with a dry cloth.

Do not use products such as solvents, thinner or household wax for cleaning, as they can damage the surface coating. (If using a chemically-treated cloth, follow the instructions supplied with the cloth.)

- Do not attach sticky tape or labels, as they can make the surface of the pedestal dirty. Do not allow long-term contact with rubber, vinyl products or the like. (Doing so will cause deterioration.)

FAQ

Before requesting service or assistance, please follow these simple guides to resolve the problem.

If problem still persists, please contact your local Panasonic dealer or Panasonic Service center for assistance. For details (p. 49, 50)

For additional assistance, please contact our website at:

www.panasonic.com/contactinfo

www.panasonic.ca

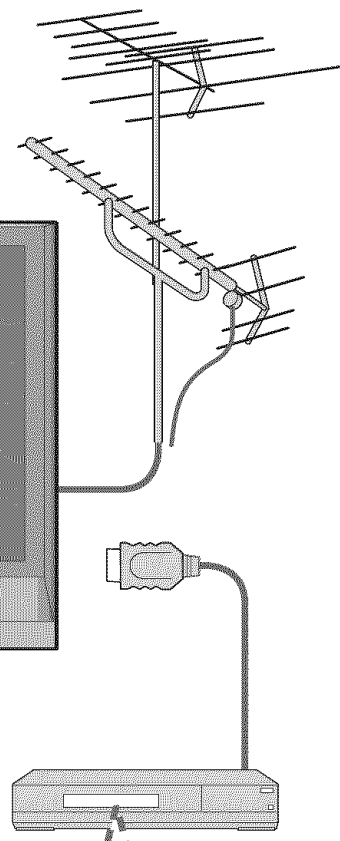

White spots or shadow images (noise)

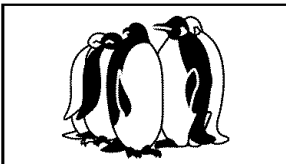
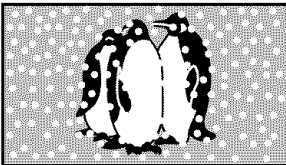

- Check the position, direction, and connection of the aerial.

Interference or frozen digital channels

(intermittent sound)



- Change the direction of antenna for digital channels .
- Check "Signal meter" (p. 28). If the signal is weak, check the antenna and consult your local dealer.

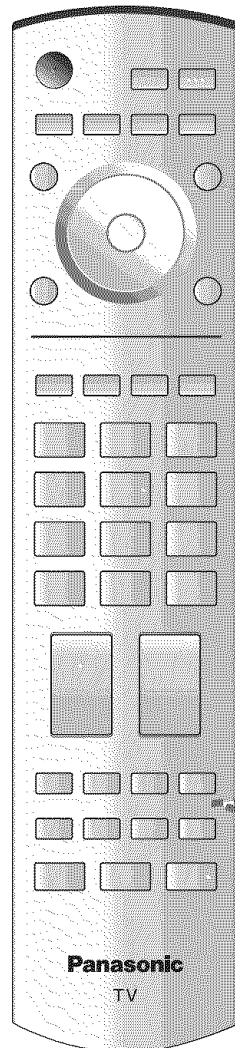
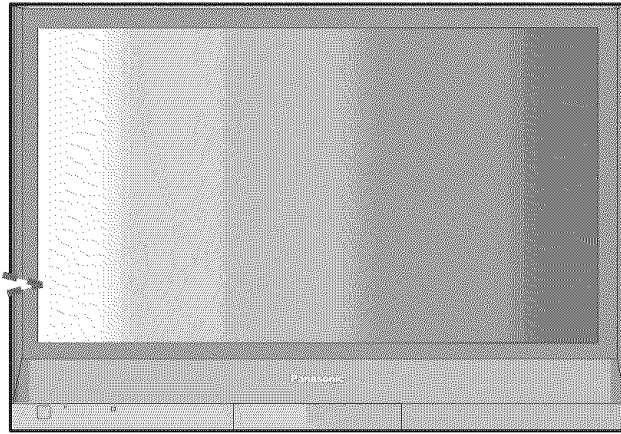

Pictures from external equipment are distorted when the unit is connected via HDMI

- Is the HDMI cable connected properly? (p. 24-25, 34-35)
- Turn Off the TV unit and equipment, then turn them On again.
- Check an input signal from the equipment. (p. 24-25, 34-35)
- Use a device compliant with EIA/CEA-861/861B.

The remote control does not work

- Are the batteries installed correctly? (p. 6)
- Has the battery run down?
- Has the TV POWER button been turned On?
- To operate external equipment of other manufacturers, register the remote control codes. (p. 33)

Before requesting service or assistance, please follow these simple guides to resolve the problem. If problem still persists, please contact your local Panasonic dealer or Panasonic Service center for assistance. For details (p. 49, 50)

	Problem	Actions
Screen	“Press any key to return” moves on the screen	<ul style="list-style-type: none"> ● The function to prevent “after image” is activated. (Not a faulty symptom) ● The screen saver is activated if the TV unit is not operated for a certain time in SD mode. ● “after image” (p. 5)
	One spot remains dark	<ul style="list-style-type: none"> ● A pixel or luminescent spot can occasionally be missing in plasma displays. (Not a faulty symptom)
	Chaotic image, noisy	<ul style="list-style-type: none"> ● Check nearby electrical products (car, motorcycle, fluorescent lamp).
	No image can be displayed	<ul style="list-style-type: none"> ● Check Picture menu (p. 20)
	Only spots are displayed instead of images	<ul style="list-style-type: none"> ● Check the channel settings. (p. 13, 28) ● Check the antenna cables.
	Neither image nor sound is produced	<ul style="list-style-type: none"> ● Is the AC power cord plugged into the outlet? ● Is the TV unit turned On? ● Check Picture menu (p. 20) and volume. ● Are the remote control codes correct? (p. 37-38)
Sound	Black Box appears	<ul style="list-style-type: none"> ● Change settings of Closed Caption (CC). (p. 30)
	No sound is produced	<ul style="list-style-type: none"> ● Is “Sound Mute” active? (p. 12) ● Is the volume set to the minimum? ● Is “Speakers” set to “Off”? (p. 20) ● Change “SAP” settings. (p. 14) ● Check “HDMI1 in” or “HDMI2 in” settings. (p. 20)
	Sound is unusual	<ul style="list-style-type: none"> ● Set “SAP” setting to “Stereo” or “Mono.” ● Check the HDMI device connected to the unit. ● Set the audio setting of the HDMI device to “Linear PCM.” ● If digital sound connection has a problem, select analog sound connection.
	Whirling sound is heard	<ul style="list-style-type: none"> ● The sound is from built-in cooling fan (not a sign of faulty operation).
HDMI	“Control with HDMI” function does not work	<ul style="list-style-type: none"> ● Switch the TV unit on again with the equipment on. ● Set “Control with HDMI” to “Off”, then set to “On” again. (p. 22)



Specifications

		TH-37PX60U	TH-42PX60U
Power Source		AC 120 V, 50 / 60 Hz	
Power Consumption	Maximum	323 W	390 W
	Standby condition	0.2 W	0.2 W
Plasma Display panel	Drive method	AC type	
	Aspect Ratio	16:9	
	Contrast Ratio	(max) 10000:1	
	Visible screen size (W × H × Diagonal)	94 cmV 32.2" × 18.2" × 37.0" (818 mm × 461 mm × 939 mm)	106 cmV 36.3" × 20.4" × 41.6" (920 mm × 518 mm × 1,056 mm)
	(No. of pixels)	737,280 (1,024 (W) × 720 (H)) [3,072 × 720 dots]	786,432 (1,024 (W) × 768 (H)) [3,072 × 768 dots]
Sound	Speaker	4.8" × 2.4" (120 mm × 60 mm) × 2pcs, 8 Ω	
	Audio Output	20 W [10 W + 10 W] (10 % THD)	
Channel Capability (Digital/Analog)		VHF/ UHF : 2-69, CATV:1-135	
Operating Conditions		Temperature : 32 °F - 104 °F (0 °C - 40 °C) Humidity : 20 % - 80 % RH (non-condensing)	
Connection Terminals	INPUT 1-3	VIDEO : RCA PIN Type × 1 1.0 V [p-p] (75 Ω) S-VIDEO : Mini DIN 4-pin Y:1.0 V [p-p] (75 Ω) C:0.286 V [p-p] (75 Ω) AUDIO L - R : RCA PIN Type × 2 0.5 V [rms]	
	COMPONENT VIDEO INPUT 1-2	Y : 1.0 V [p-p] (including synchronization) Pb, Pr: ±0.35 V [p-p] AUDIO L-R : RCA PIN Type × 2 0.5 V [rms]	
	HDMI 1-2	TYPE A Connector AUDIO L-R: RCA PIN Type × 2 0.5 V [rms]	
	Card slot	SD CARD slot × 1	
	AV PROG. OUT	VIDEO: RCA PIN Type × 1 1.0 V [p-p] (75 Ω) AUDIO L - R: RCA PIN Type × 2 0.5 V [rms]	
	DIGITAL AUDIO OUT	PCM / Dolby Digital, Fiber Optic	
FEATURES		3D Y/C FILTER CLOSED CAPTION V-Chip Photo Viewer	
Dimensions (W × H × D)	Including pedestal	36.1" × 27.9" × 12.7" (917 mm × 708 mm × 321 mm)	40.2" × 30.3" × 12.7" (1,020 mm × 768 mm × 321 mm)
	TV Set only	36.1" × 25.4" × 3.8" (917 mm × 645 mm × 95 mm)	40.2" × 27.8" × 3.8" (1,020 mm × 705 mm × 95 mm)
Weight	Including pedestal	61.7 lb. (28 kg)	70.5 lb. (32 kg)
	TV Set only	57.3 lb. (26 kg)	66.1 lb. (30 kg)

[TH-37PX60U]

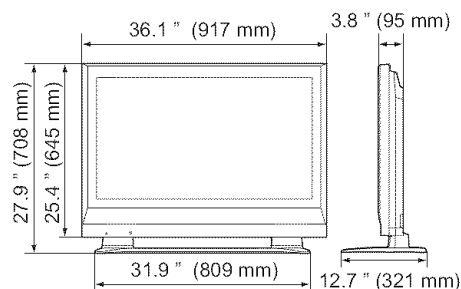

[TH-42PX60U]

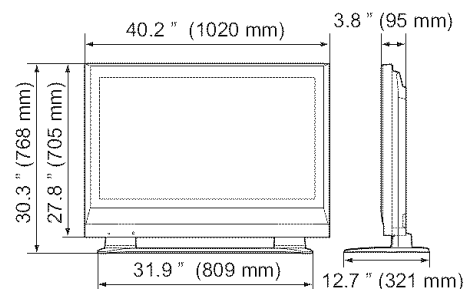

Note

- Design and Specifications are subject to change without notice. Weight and Dimensions shown are approximate.

		TH-50PX60U, TH-50PX60X	TH-58PX60U
Power Source		AC 120 V, 50 / 60 Hz (TH-50PX60U, TH-58PX60U) AC 110 - 127 V, 50 / 60 Hz (TH-50PX60X)	
Power Consumption	Maximum	515 W	655 W
	Standby condition	0.2 W	0.2 W
Plasma Display panel	Drive method	AC type	
	Aspect Ratio	16:9	
	Contrast Ratio	(max) 10000:1	
	Visible screen size (W × H × Diagonal)	127 cmV 43.6" × 24.5" × 50.0" (1,106 mm × 622 mm × 1,269 mm)	148 cmV 50.7" × 28.5" × 58.1" (1,287 mm × 723 mm × 1,476 mm)
(No. of pixels)	1,049,088 (1,366 (W) × 768(H)) [4,098 × 768 dots]	1,049,088 (1,366 (W) × 768(H)) [4,098 × 768 dots]	
Sound	Speaker	4.8" × 2.4" (120 mm × 60 mm) × 2pcs, 8 Ω	
	Audio Output	20 W [10 W + 10 W] (10 % THD)	
Channel Capability (Digital/Analog)	VHF/ UHF : 2-69, CATV:1-135		
Operating Conditions	Temperature : 32 °F - 104 °F (0 °C - 40 °C) Humidity : 20 % - 80 % RH (non-condensing)		
Connection Terminals	INPUT 1-3	VIDEO : RCA PIN Type × 1 1.0 V [p-p] (75 Ω) S-VIDEO : Mini DIN 4-pin Y:1.0 V [p-p] (75 Ω) C:0.286 V [p-p] (75 Ω) AUDIO L - R : RCA PIN Type × 2 0.5 V [rms]	
	COMPONENT VIDEO INPUT 1-2	Y : 1.0 V [p-p] (including synchronization) PB, PR: ±0.35 V [p-p] AUDIO L-R : RCA PIN Type × 2 0.5 V [rms]	
	HDMI 1-2	TYPE A Connector AUDIO L-R: RCA PIN Type × 2 0.5 V [rms]	
	Card slot	SD CARD slot × 1	
	AV PROG. OUT	VIDEO: RCA PIN Type × 1 1.0 V [p-p] (75 Ω) AUDIO L - R: RCA PIN Type × 2 0.5 V [rms]	
	DIGITAL AUDIO OUT	PCM / Dolby Digital, Fiber Optic	
FEATURES	3D Y/C FILTER CLOSED CAPTION V-Chip Photo Viewer		
Dimensions (W × H × D)	Including pedestal	47.7" × 34.8" × 14.6" (1,210 mm × 882 mm × 371 mm)	55.1" × 39.3" × 16.9" (1,399 mm × 997 mm × 430 mm)
	TV Set only	47.7" × 32.2" × 3.8" (1,210 mm × 818 mm × 95 mm)	55.1" × 36.8" × 3.9" (1,399 mm × 934 mm × 99 mm)
Weight	Including pedestal	93.7 lb. (42.5 kg)	138.9 lb. (63 kg)
	TV Set only	88.2 lb. (40 kg)	130.1 lb. (59 kg)

[TH-50PX60U, TH-50PX60X]

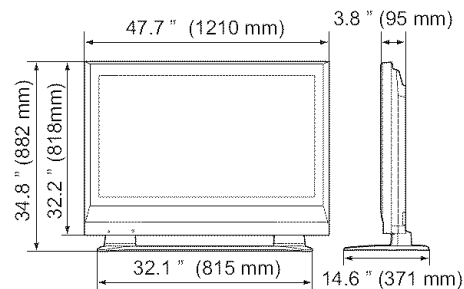

[TH-58PX60U]

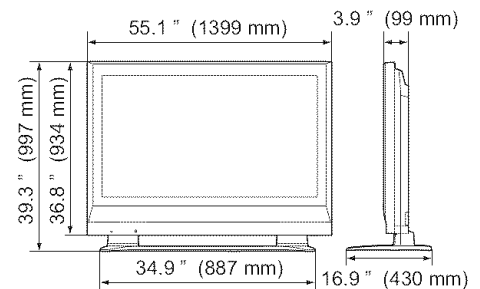

Note

● Design and Specifications are subject to change without notice. Weight and Dimensions shown are approximate.

Limited Warranty (for U.S.A.)

PANASONIC CONSUMER ELECTRONICS COMPANY,
DIVISION OF
PANASONIC CORPORATION OF NORTH AMERICA
One Panasonic Way
Secaucus, New Jersey 07094

PANASONIC SALES COMPANY,
DIVISION OF
PANASONIC PUERTO RICO INC.
Ave. 65 de Infanteria, Km. 9.5
San Gabriel Industrial Park
Carolina, Puerto Rico 00985

Panasonic Color Television Limited Warranty

Limited Warranty Coverage

If your product does not work properly because of a defect in materials or workmanship, Panasonic Consumer Electronics Company or Panasonic Puerto Rico, Inc. (collectively referred to as "the warrantor") will, for the length of the period indicated on the chart below, which starts with the date of original purchase ("Limited Warranty period"), at its option either (a) repair your product with new or refurbished parts, or (b) replace it with a new or a refurbished product. The decision to repair or replace will be made by the warrantor.

CATEGORIES	ALL PARTS EXCEPT GLASS PANEL OR CRT	LABOR	GLASS PANEL OR CRT	GLASS PANEL OR CRT LABOR	SERVICE
PLASMA DISPLAY	1 (ONE) YEAR	1 (ONE) YEAR	GLASS PANEL - 2 (TWO) YEARS	1 (ONE) YEAR	IN-HOME OR CARRY-IN

During the "Labor" Limited Warranty period there will be no charge for labor. During the "Parts" Limited Warranty period, there will be no charge for parts.

You must carry-in your product or arrange for in-home service during the Limited Warranty period. If non-rechargeable batteries are included, they are not warranted. This Limited Warranty only applies to products purchased and serviced in the United States or Puerto Rico. This Limited Warranty is extended only to the original purchaser and only covers product purchased as new. A purchase receipt or other proof of the original purchase date is required for Limited Warranty service.

In-Home or Carry-in Service

For In-Home or Carry-In Service in the United States call 1-888-VIEW-PTV(1-888-843-9788).

For assistance in Puerto Rico call Panasonic Puerto Rico, Inc. (787)-750-4300 or fax (787)-768-2910.

In-Home service requires clear, complete and easy access to the product by the authorized servicer and does not include removal or re-installation of an installed product. It is possible that certain in-home repairs will not be completed in-home, but will require that the product, or parts of the product, be removed for shop diagnosis and/or repair and then returned.

Limited Warranty Limits And Exclusions

This Limited Warranty ONLY COVERS failures due to defects in materials or workmanship, and DOES NOT COVER normal wear and tear or cosmetic damage, nor does it cover markings or retained images on the picture tube resulting from viewing fixed images (including, among other things, letterbox pictures on standard 4:3 screen TV's, or non-expanded standard 4:3 pictures on wide screen TV's, or onscreen data in a stationary and fixed location). The Limited Warranty ALSO DOES NOT COVER damages which occurred in shipment, or failures which are caused by products not supplied by the warrantor, or failures which result from accidents, misuse, abuse, neglect, bug infestation, mishandling, misapplication, alteration, faulty installation, set-up adjustments, misadjustment of consumer controls, improper maintenance, power line surge, lightning damage, modification, or commercial use (such as in a hotel, office, restaurant, or other business), rental use of the product, service by anyone other than a Factory Servicenter or other Authorized Servicer, or damage that is attributable to acts of God.

THERE ARE NO EXPRESS WARRANTIES EXCEPT AS LISTED UNDER "LIMITED WARRANTY COVERAGE". THE WARRANTOR IS NOT LIABLE FOR INCIDENTAL OR CONSEQUENTIAL DAMAGES RESULTING FROM THE USE OF THIS PRODUCT, OR ARISING OUT OF ANY BREACH OF THIS LIMITED WARRANTY. (As examples, this excludes damages for lost time, cost of having someone remove or re-install an installed unit if applicable, or travel to and from the servicer. The items listed are not exclusive, but are for illustration only.) **ALL EXPRESS AND IMPLIED WARRANTIES, INCLUDING THE LIMITED WARRANTY OF MERCHANTABILITY, ARE LIMITED TO THE PERIOD OF THE LIMITED WARRANTY.**

Some states do not allow the exclusion or limitation of incidental or consequential damages, or limitations on how long an implied Limited Warranty lasts, so the exclusions may not apply to you.

This Limited Warranty gives you specific legal rights and you may also have others rights which vary from state to state. If a problem with this product develops during or after the Limited Warranty period, you may contact your dealer or Servicenter. If the problem is not handled to your satisfaction, then write to the warrantor's Consumer Affairs Department at the addresses listed for the warrantor.

PARTS AND SERVICE (INCLUDING COST OF AN IN-HOME SERVICE CALL, WHERE APPLICABLE) WHICH ARE NOT COVERED BY THIS LIMITED WARRANTY ARE YOUR RESPONSIBILITY.

Customer Services Directory (for U.S.A.)

Customer Services Directory

Obtain Product Information and Operating Assistance; locate your nearest Dealer or Service center; purchase Parts and Accessories; or make Customer Service and Literature requests by visiting our Web Site at:

<http://www.panasonic.com/consumersupport>

or, contact us via the web at:

<http://www.panasonic.com/contactinfo>

You may also contact us directly at:

1-888-VIEW-PTV (843-9788)

Monday-Friday 9 am-9 pm; Saturday-Sunday 10 am-7 pm, EST.

■ For hearing or speech impaired TTY users, TTY : 1-877-833-8855

Accessory Purchases

Purchase Parts, Accessories and Instruction Books on line for all Panasonic Products by visiting our Web Site at:

<http://www.pasc.panasonic.com>

or, send your request by E-mail to:

npcparts@us.panasonic.com

You may also contact us directly at:

1-800-332-5368 (Phone) 1-800-237-9080 (Fax Only) (Monday - Friday 9 am to 8 pm, EST.)

Panasonic Services Company

20421 84th Avenue South,

Kent, WA 98032

(We Accept Visa, MasterCard, Discover Card, American Express, and Personal Checks)

■ For hearing or speech impaired TTY users, TTY : 1-866-605-1277

Service in Puerto Rico

Panasonic Puerto Rico, Inc.

Ave. 65 de Infantería, Km. 9.5, San Gabriel Industrial Park,

Carolina, Puerto Rico 00985

Phone (787)750-4300, Fax (787)768-2910

Limited Warranty (for Canada)

Panasonic Canada Inc.

PANASONIC PRODUCT - LIMITED WARRANTY

Panasonic Canada Inc. warrants this product to be free from defects in material and workmanship and agrees to remedy any such defect for a period as stated below from the date of original purchase.

Plasma TV / Monitor	In-home service	One (1) year, parts (including Plasma Panel) and labour.
LCD TV (26 in & over)	In-home service	One (1) year, parts (including LCD Panel) and labour.
LCD TV (25 in & under)	Carry-in service only	One (1) year, parts (including LCD Panel) and labour.

In-home Service will be carried out only to locations accessible by roads and within 50 km of an authorized Panasonic service facility.

LIMITATIONS AND EXCLUSIONS

This warranty does not apply to products purchased outside Canada or to any product which has been improperly installed, subjected to usage for which the product was not designed, misused or abused, damaged during shipping, or which has been altered or repaired in any way that affects the reliability or detracts from the performance, nor does it cover any product which is used commercially. Dry cell batteries are also excluded from coverage under this warranty.

This warranty is extended to the original end user purchaser only. A purchase receipt or other proof of date of original purchase is required before warranty service is performed.

THIS EXPRESS, LIMITED WARRANTY IS IN LIEU OF ALL OTHER WARRANTIES, EXPRESS OR IMPLIED, INCLUDING ANY IMPLIED WARRANTIES OF MERCHANTABILITY AND FITNESS FOR A PARTICULAR PURPOSE. IN NO EVENT WILL PANASONIC CANADA INC. BE LIABLE FOR ANY SPECIAL, INDIRECT OR CONSEQUENTIAL DAMAGES.

In certain instances, some jurisdictions do not allow the exclusion or limitation of incidental or consequential damages, or the exclusion of implied warranties, so the above limitations and exclusions may not be applicable.

In-home service requires clear, complete and easy access to the product by the Authorized Servicentre and does not include removal or re-installation of an installed product. If removal is required to service the product, it will be at the discretion of the Servicentre and in no event will Panasonic Canada Inc. or the Servicentre be liable for any special, indirect or consequential damages.

WARRANTY SERVICE

For product operation and information assistance, please contact:

Our Customer Care Centre: Telephone #: (905) 624-5505
1-800 #: 1-800-561-5505
Fax #: (905) 238-2360
Email link: "Customer support" on www.panasonic.ca

FOR PRODUCT REPAIRS, please locate your nearest Authorized Servicentre at www.panasonic.ca :

Link: "Servicentres™ locator" under "Customer support"

IF YOU SHIP THE PRODUCT TO A SERVICENTRE

Carefully pack and send prepaid, adequately insured and preferably in the original carton.
Include details of the defect claimed, and proof of date of original purchase.

Customer's Record

The model number and serial number of this product can be found on its back cover. You should note this serial number in the space provided below and retain this book, plus your purchase receipt, as a permanent record of your purchase to aid in identification in the event of theft or loss, and for Warranty Service purposes.

Model Number _____

Serial Number _____

**Panasonic Consumer Electronics Company,
Division of Panasonic Corporation of
North America**

One Panasonic Way, Secaucus New Jersey
07094 U.S.A.

Panasonic Canada Inc.

5770 Ambler Drive Mississauga, Ontario L4W 2T3
CANADA

**Panasonic Puerto Rico Inc.
("PSC")**

Ave. 65 de Infanteria, Km 9.5 San Gabriel Industrial
Park, Carolina, Puerto Rico 00985

Panasonic De México S.A. De C.V.

Moras No.313, Col. Tlacoquemecatl Del Valle Del.
Benito Juárez
MÉXICO, D.F. C.P. 03200

