

# **VEVOR<sup>®</sup>**

## **TOUGH TOOLS, HALF PRICE**

Technical Support and E-Warranty Certificate [www.vevor.com/support](http://www.vevor.com/support)

### **STAINLESS STEEL HANDRAIL**

**MODEL:SSH-1S-80-2 \ SSH-1S-100-0 \ SSH-1S-100-2  
SSH-1S-120-2 \ SSH-1S-120-3 \ SSH-1S-150-0 \ SSH-1S-150-3  
SSH-1S-150-5 \ SSH-1S-180-0 \ SSH-1S-180-2**

We continue to be committed to provide you tools with competitive price. "Save Half", "Half Price" or any other similar expressions used by us only represents an estimate of savings you might benefit from buying certain tools with us compared to the major top brands and does not necessarily mean to cover all categories of tools offered by us. You are kindly reminded to verify carefully when you are placing an order with us if you are actually saving half in comparison with the top major brands.



# VEVOR<sup>®</sup>

TOUGH TOOLS, HALF PRICE

STAINLESS STEEL  
HANDRAIL

**MODEL:** SSH-1S-80-2 \ SSH-1S-100-0 \ SSH-1S-100-2 \ SSH-1S-120-2  
SSH-1S-120-3 \ SSH-1S-150-0\SSH-1S-150-3\SSH-1S-150-5  
SSH-1S-180-0 \ SSH-1S-180-2



(**PS:** The number of cross bars:0、2、3、5.)

## NEED HELP? CONTACT US!

Have product questions? Need technical support? Please feel free to contact us:

**Technical Support and E-Warranty Certificate**  
[www.vevor.com/support](http://www.vevor.com/support)

This is the original instruction, please read all manual instructions carefully before operating. VEVOR reserves a clear interpretation of our user manual. The appearance of the product shall be subject to the product you received. Please forgive us that we won't inform you again if there are any technology or software updates on our product.

## SAFE INSTRUCTIONS

**CAUTION:** Carefully read instructions and procedures for safe operations. Failure to do so can result in serious injury.

### **WARNING:**

1. Before using the handrail, ensure that the handrail is securely installed to prevent personal injury and accidents.
2. When using the handrail, do not overload the handrail to avoid personal injury or accident.
3. Do not draw, cut, or use sharp objects on the handrail to avoid damage.
4. If you need to disassemble the handrail, please follow the reverse steps to disassemble and store it properly.
5. This product is not a toy. Do not allow children to play with this item.







## ASSEMBLY PRECAUTIONS

1. Assemble only according to these instructions. Improper assembly can create hazards.
2. Wear ANSI-approved safety goggles and heavy-duty work gloves during assembly.
3. Keep assembly area clean and well-lit.
4. Keep bystanders out of the area during assembly.
5. Do not assemble when tired or under the influence of alcohol, drugs or medication.
6. Product capabilities apply to properly and completely assembled products only.
7. For additional information regarding the parts listed in the following pages, please refer to the Assembly Diagram of this manual. Unwrap and separate all parts in a clean work area.
8. For safety reasons, this hardware is recommended to be installed by 2 people .

**SAVE THESE INSTRUCTIONS**





No.	Model	Length Of Handrail (mm)	No. Of Cross Bars(pcs)
1	SSH-1S-80-2	800	2
2	SSH-1S-100-0	1000	0
3	SSH-1S-100-2		2
4	SSH-1S-120-2	1200	2
5	SSH-1S-120-3		3
6	SSH-1S-150-0	1500	0
7	SSH-1S-150-3		3
8	SSH-1S-150-5		5
9	SSH-1S-180-0	1800	0
10	SSH-1S-180-2		2

## Sheet 1

Part List							
No.	Name	Picture	QTY.				
			SSH -1S -80 -2	SSH -1S -100 -0	SSH -1S -100 -2	SSH -1S -120 -2	SSH -1S -120 -3
A	Handrail		1	1	1	1	1
B	Column		2	2	2	2	2
C	Column Head		2	2	2	2	2
D	Screw M6*12		2	2	2	2	2
E	Screw M6*25		2	2	2	2	2
F	Expansion Bolt		6	6	6	6	6

G	Decorative Cover		2	2	2	2	2
H&I &J	Cross bar mounting accessories		4 set	0 set	4 set	4 set	6 set
K	Cross Bar		2	0	2	2	3
L	Wrench		1	1	1	1	1
M	Hex Key 3		1	1	1	1	1
N	Hex Key 4		1	1	1	1	1
O	Hex Key 5		1	1	1	1	1
P	Drill Bit		1	1	1	1	1

## Sheet 2

Part List							
No.	Name	Picture	QTY.				
			SSH -1S -150 -0	SSH -1S -150 -3	SSH -1S -150 -5	SSH -1S -180 -0	SSH -1S -180 -2
A	Handrail		1	1	1	1	1
B	Column		2	2	2	2	2
C	Column Head		2	2	2	2	2
D	Screw M6*12		2	2	2	2	2

E	Screw M6*25		2	2	2	2	2
F	Expansion Bolt		6	6	6	6	6
G	Decorative Cover		2	2	2	2	2
H& I&J	Cross bar mounting accessories		0 set	6set	10 set	0 set	4 set
K	Cross Bar		0	3	5	0	2
L	Wrench		1	1	1	1	1
M	Hex Key 3		1	1	1	1	1
N	Hex Key 4		1	1	1	1	1
O	Hex Key 5		1	1	1	1	1
P	Drill Bit		1	1	1	1	1

## Product Assembly

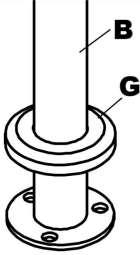
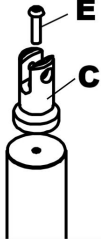
	
<b>STEP 1:</b> Put in Decorative Cover.	<b>STEP 2:</b> Lock the column head firmly.

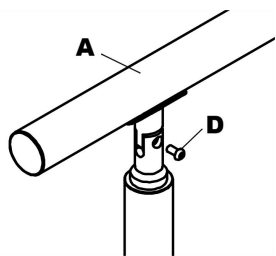

**STEP 3:** Install handrail.

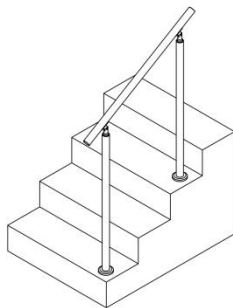

**STEP 4:** Put the handrail on the stairs.

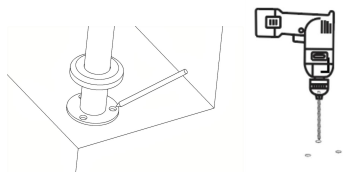

**STEP 5:** Mark the installation location and drill holes.

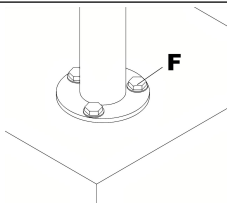

**STEP 6:** Mounting expansion bolt.

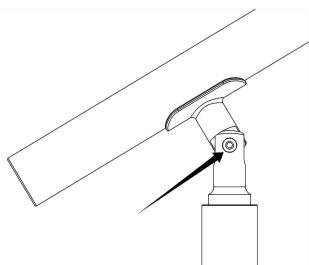

**STEP 7:** Lock screws.

- If the product has some cross bars, install them in the same way as installing SSH-1S-100-2.



<p><b>STEP 1:</b> Put in Decorative Cover.</p>	<p><b>STEP 2:</b> Lock the column head firmly.</p>
<p><b>STEP 3:</b> Install handrail.</p>	<p><b>STEP 4:</b> Assemble the crossbar assembly.</p>

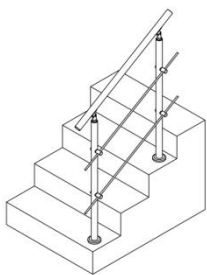

**STEP 5:** Put the handrail on the stairs.

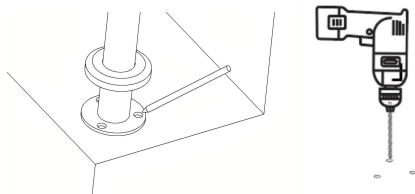

**STEP 6:** Mark the installation location and drill holes.

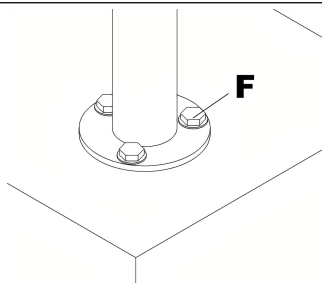

**STEP 7:** Mounting expansion bolt.

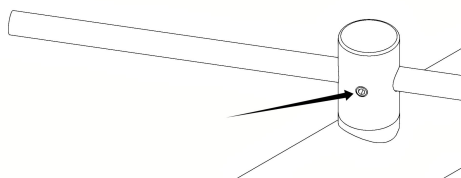

**STEP 8:** Lock firmly set screws.

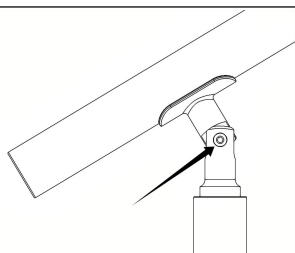

**STEP 9:** Lock screws.

**Manufacturer:** Shanghaimuxinmuyeyouxiangongsi

**Address:** Shuangchenglu 803nong11hao1602A-1609shi, baoshanqu, shanghai 200000 CN.

**Imported to AUS:** SIHAO PTY LTD. 1 ROKEVA STREETEASTWOOD NSW 2122 Australia

**Imported to USA:** Sanven Technology Ltd. Suite 250, 9166 Anaheim Place, Rancho Cucamonga, CA 91730

<b>UK</b>	<b>REP</b>
-----------	------------

YH CONSULTING LIMITED.  
C/O YH Consulting Limited Office 147,  
Centurion House, London Road,  
Staines-upon-Thames, Surrey, TW18 4AX

<b>EC</b>	<b>REP</b>
-----------	------------

E-CrossStu GmbH  
Mainzer Landstr.69,  
60329 Frankfurt am Main.

**VEVOR<sup>®</sup>**

**TOUGH TOOLS, HALF PRICE**

**Technical Support and E-Warranty Certificate**

**[www.vevor.com/support](http://www.vevor.com/support)**

# VEVOR<sup>®</sup>

## TOUGH TOOLS, HALF PRICE

Assistance technique et certificat de garantie électronique [www.vevor.com/support](http://www.vevor.com/support)

### MAIN COURANTE EN ACIER INOXYDABLE

MODÈLE : SSH-1S-80-2 \ SSH-1S-100-0 \ SSH-1S-100-2  
SSH-1S-120-2 \ SSH-1S-120-3 \ SSH-1S-150-0 \ SSH-1S-150-3  
SSH-1S-150-5 \ SSH-1S-180-0 \ SSH-1S-180-2

Nous continuons à nous engager à vous fournir des outils à des prix compétitifs.

"Économisez la moitié", "Moitié prix" ou toute autre expression similaire que nous utilisons ne représente qu'une estimation des économies dont vous pourriez bénéficier en achetant certains outils chez nous par rapport aux grandes marques et ne signifie pas nécessairement couvrir toutes les catégories d'outils proposés, par nous.

Nous vous rappelons de bien vouloir vérifier attentivement lorsque vous passez une commande chez nous si vous économisez réellement la moitié par rapport aux grandes marques.



**VEVOR**<sup>®</sup>  
TOUGH TOOLS, HALF PRICE

ACIER INOXYDABLE  
BALUSTRADE

MODÈLE : SSH-1S-80-2 \ SSH-1S-100-0 \ SSH-1S-100-2 \ SSH-1S-120-2  
SSH-1S-120-3 \ SSH-1S-150-0\SSH-1S-150-3\SSH-1S-150-5  
SSH-1S-180-0 \ SSH-1S-180-2



(PS : Le nombre de barres transversales : 0235.)

### BESOIN D'AIDE? CONTACTEZ-NOUS!

Vous avez des questions sur les produits ? Besoin d'une assistance technique ? N'hésitez pas à nous

contacter : Support technique et certificat de garantie électronique  
[www.vevor.com/support](http://www.vevor.com/support)

Il s'agit des instructions originales, veuillez lire attentivement toutes les instructions du manuel avant de l'utiliser. VEVOR se réserve une interprétation claire de notre manuel d'utilisation. L'apparence du produit dépend du produit que vous avez reçu. Veuillez nous pardonner que nous ne vous informerons plus s'il y a des mises à jour technologiques ou logicielles sur notre produit.

## CONSIGNES DE SÉCURITÉ

ATTENTION : Lisez attentivement les instructions et les procédures pour des opérations sûres.

Ne pas le faire peut entraîner des blessures graves.



AVERTISSEMENT:

1. Avant d'utiliser la main courante, assurez-vous qu'elle est solidement installée sur prévenir les blessures et les accidents.
2. Lorsque vous utilisez la main courante, ne surchargez pas la main courante pour éviter les blessures personnelles. blessure ou accident.
3. Ne dessinez pas, ne coupez pas et n'utilisez pas d'objets pointus sur la main courante pour éviter tout dommage.
4. Si vous devez démonter la main courante, veuillez suivre les étapes inverses pour le démonter et le ranger correctement.
5. Ce produit n'est pas un jouet. Ne laissez pas les enfants jouer avec cet article.







## PRÉCAUTIONS DE MONTAGE

1. Assemblez uniquement selon ces instructions. Un assemblage incorrect peut créer des dangers.
2. Portez des lunettes de sécurité approuvées par l'ANSI et des gants de travail robustes pendant assemblée.
3. Gardez la zone de rassemblement propre et bien éclairée.
4. Gardez les spectateurs hors de la zone pendant l'assemblage.
5. Ne vous rassemblez pas lorsque vous êtes fatigué ou sous l'influence de l'alcool, de drogues ou de médicament.
6. Les capacités du produit s'appliquent à un assemblage correct et complet produits uniquement.
7. Pour plus d'informations concernant les pièces répertoriées dans ce qui suit pages, veuillez vous référer au schéma d'assemblage de ce manuel. Déballez et séparez toutes les pièces dans une zone de travail propre.
8. Pour des raisons de sécurité, il est recommandé d'installer ce matériel avant 2 heures. personnes .

CONSERVEZ CES INSTRUCTIONS





Non.	Modèle	Longueur de la main courante (mm)	Nombre de croix Barres (pièces)
1	SSH-1S-80-2	800	2
2	SSH-1S-100-0	1000	0
3	SSH-1S-100-2		2
4	SSH-1S-120-2	1200	2
5	SSH-1S-120-3		3
6	SSH-1S-150-0	1500	0
7	SSH-1S-150-3		3
8	SSH-1S-150-5		5
9	SSH-1S-180-0	1800	0
10	SSH-1S-180-2		2

## Feuille 1

Liste des pièces						
Sans nom	Image	QTÉ.				
		SSH -1S -80 -2	SSH -1S -100 -0	SSH -1S -100 -2	SSH -1S -120 -2	SSH -1S -120 -3
Une main courante		1	1	1	1	1
B	Colonne 	2	2	2	2	2
C	Colonne Tête 	2	2	2	2	2
D	Vis M6*12 	2	2	2	2	2
ET	Vis M6*25 	2	2	2	2	2
F	Expansion Boulon 	6	6	6	6	6

g	Décoratif Couverture		2	2	2	2	2
SALUT &J	Barre transversale montage accessoires		4 séries	0 séries	4 séries	4 séries	6 ensemble
	Barre transversale K		2	0	2	2	3
L	Clé		1	1	1	1	1
	Clé hexagonale M 3		1	1	1	1	1
	N Clé hexagonale 4		1	1	1	1	1
	O Clé hexagonale 5		1	1	1	1	1
P.	Foret		1	1	1	1	1

## Feuille 2

Liste des pièces								
Non.	Nom	Image	QTÉ.					
			SSH -1S -150 -0	SSH -1S -150 -3	SSH -1S -150 -5	SSH -1S -180 -0	SSH -1S -180 -2	
	Une main courante		1	1	1	1	1	
B	Colonne		2	2	2	2	2	
C	Colonne Tête		2	2	2	2	2	
D	Vis M6*12		2	2	2	2	2	

ET	Vis M6*25		2	2	2	2	2
F	Expansion Boulon		6	6	6	6	6
g	Décoratif Couverture		2	2	2	2	2
H& I&J	Barre transversale montage accessoires		0 ensemble	6 ensemble	10 ensemble	0 ensemble	4 ensemble
	Barre transversale K		0	3	5	0	2
L	Clé		1	1	1	1	1
	Clé hexagonale M 3		1	1	1	1	1
	N Clé hexagonale 4		1	1	1	1	1
	O Clé hexagonale 5		1	1	1	1	1
P.	Foret		1	1	1	1	1

### Assemblage du produit

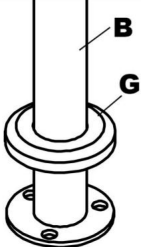
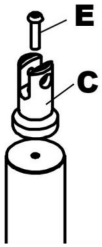
	
<p>ÉTAPE 1 : Mettez la couverture décorative. ÉTAPE 2 : Verrouillez fermement la tête de colonne.</p>	

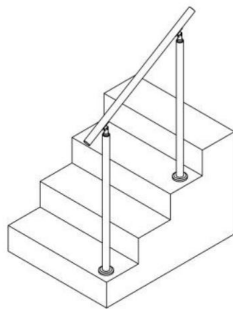
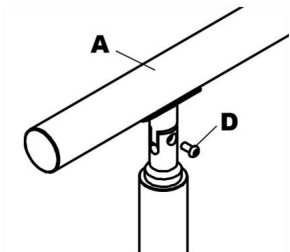

ÉTAPE 3 : Installez la main courante.

ÉTAPE 4 Placez la main courante sur les escaliers.

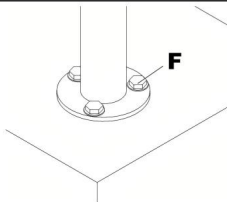
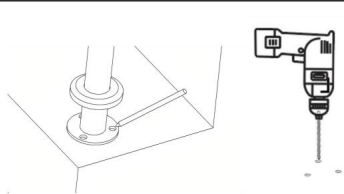

ÉTAPE 5 : Marquer l'installation  
emplacement et perçage des trous.

ÉTAPE 6 : Montage du boulon d'expansion.

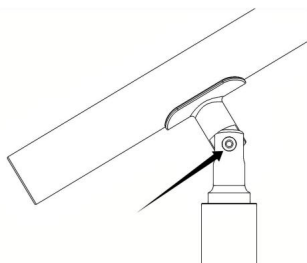

ÉTAPE 7 : Verrouillez les vis.

Si le produit comporte des barres transversales, installez-les de la même manière que pour l'installation du SSH-1S-100-2.

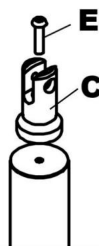
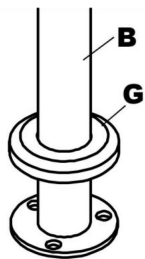

ÉTAPE 1 : Mettez la couverture décorative. ÉTAPE 2 : Verrouillez fermement la tête de colonne.

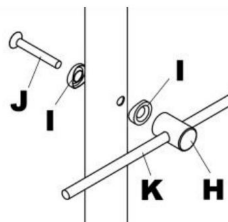
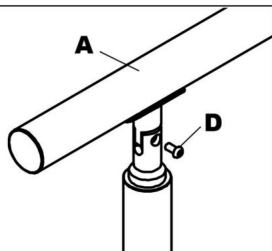

ÉTAPE 3 : Installez la main courante.

ÉTAPE 4 : Assemblez la barre transversale assemblée.

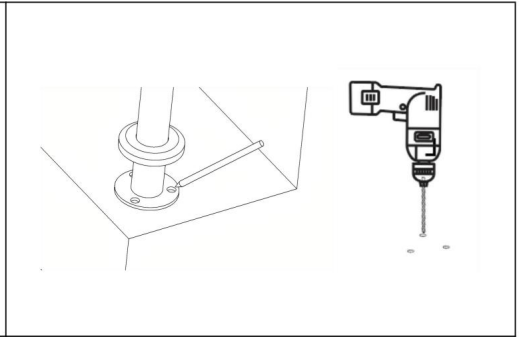
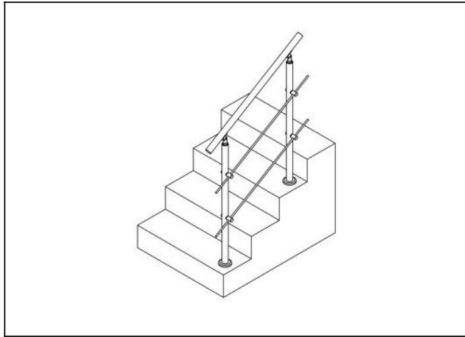

ÉTAPE 5 : Placez la main courante sur les escaliers.

ÉTAPE 6 : Marquez l'emplacement d'installation et percez des trous.

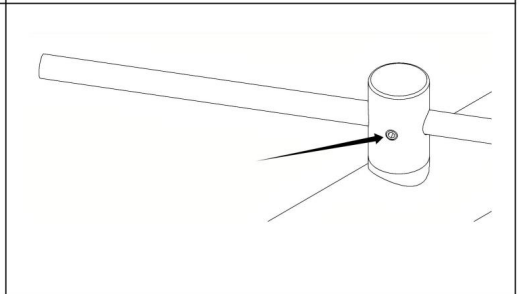
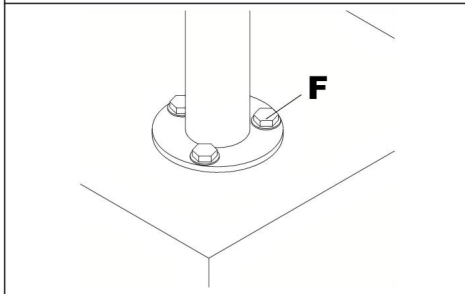

ÉTAPE 7 : Montage du boulon d'expansion. ÉTAPE 8 : Verrouillez fermement les vis de réglage.

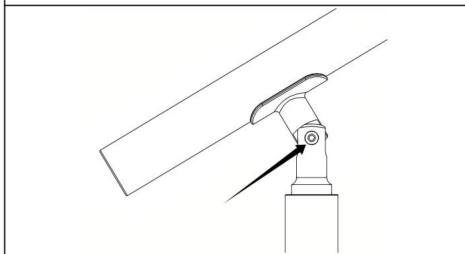

ÉTAPE 9 : Verrouillez les vis.

Fabricant : Shanghaimuxinmuyeyouxiangongsi

Adresse : Shuangchenglu 803nong11hao1602A-1609shi, baoshanqu, shanghai  
200000 CN.

Importé en Australie : SIHAO PTY LTD. 1 RUE ROKEVAASTWOOD  
NSW 2122 Australie

Importé aux États-Unis : Sanven Technology Ltd. Suite 250, 9166 Anaheim  
Lieu, Rancho Cucamonga, CA 91730



YH CONSULTING LIMITÉE.

C/O YH Consulting Limited Bureau 147,  
Centurion House, London Road,  
Staines-upon-Thames, Surrey, TW18 4AX

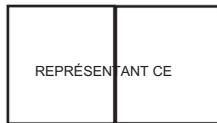

E-CrossStu GmbH

Mainzer Landstr.69,  
60329 Francfort-sur-le-Main.

**VEVOR**®

**TOUGH TOOLS, HALF PRICE**

Assistance technique et certificat de garantie  
électronique [www.vevor.com/support](http://www.vevor.com/support)

# **VEVOR<sup>®</sup>**

## **TOUGH TOOLS, HALF PRICE**

Technischer Support und E-Garantie-Zertifikat [www.vevor.com/support](http://www.vevor.com/support)

### **EDELSTAHL-HANDLAUF**

MODELL: SSH-1S-80-2 \ SSH-1S-100-0 \ SSH-1S-100-2  
SSH-1S-120-2 \ SSH-1S-120-3 \ SSH-1S-150-0 \ SSH-1S-150-3  
SSH-1S-150-5 \ SSH-1S-180-0 \ SSH-1S-180-2

Wir sind weiterhin bestrebt, Ihnen Werkzeuge zu wettbewerbsfähigen Preisen anzubieten. „Sparen Sie die Hälfte“, „Halber Preis“ oder andere ähnliche Ausdrücke, die wir verwenden, stellen nur eine Schätzung der Ersparnis dar, die Sie beim Kauf bestimmter Werkzeuge bei uns im Vergleich zu den großen Topmarken erzielen können, und decken nicht unbedingt alle von uns angebotenen Werkzeugkategorien ab. Wir möchten Sie freundlich daran erinnern, bei Ihrer Bestellung bei uns sorgfältig zu prüfen, ob Sie im Vergleich zu den großen Topmarken tatsächlich die Hälfte sparen.



**VEVOR**<sup>®</sup>  
TOUGH TOOLS, HALF PRICE

EDELSTAHL  
GELÄNDER

**MODELL:** SSH-1S-80-2 \ SSH-1S-100-0 \ SSH-1S-100-2 \ SSH-1S-120-2  
SSH-1S-120-3 \ SSH-1S-150-0\SSH-1S-150-3\SSH-1S-150-5  
SSH-1S-180-0 \ SSH-1S-180-2



**(PS:** Anzahl der Querbalken: 0, 2, 3, 5.)

### **Brauchen Sie Hilfe? Kontaktieren Sie uns!**

Haben Sie Fragen zum Produkt? Benötigen Sie technischen Support? Bitte kontaktieren Sie uns:

**Technischer Support und E-Garantie-Zertifikat [www.vevor.com/support](http://www.vevor.com/support)**

Dies ist die Originalanleitung. Bitte lesen Sie alle Anweisungen sorgfältig durch, bevor Sie das Gerät in Betrieb nehmen. VEVOR behält sich eine klare Auslegung unserer Bedienungsanleitung vor. Das Erscheinungsbild des Produkts richtet sich nach dem Produkt, das Sie erhalten haben. Bitte verzeihen Sie uns, dass wir Sie nicht erneut informieren, wenn es Technologie- oder Software-Updates für unser Produkt gibt.

## SICHERE ANWEISUNGEN

**ACHTUNG:** Lesen Sie die Anweisungen und Verfahren für einen sicheren Betrieb sorgfältig durch. Andernfalls kann es zu schweren Verletzungen kommen.



### **WARNUNG:**

1. Stellen Sie vor der Verwendung des Handlaufs sicher, dass der Handlauf sicher installiert ist um Personenschäden und Unfälle zu verhindern.
2. Wenn Sie den Handlauf benutzen, überlasten Sie ihn nicht, um Verletzungen zu vermeiden. Verletzungen oder Unfälle.
3. Um Schäden zu vermeiden, ziehen, schneiden oder verwenden Sie keine scharfen Gegenstände am Handlauf.
4. Wenn Sie den Handlauf demontieren müssen, befolgen Sie bitte die Schritte in umgekehrter Reihenfolge um es ordnungsgemäß zu zerlegen und zu lagern.
5. Dieses Produkt ist kein Spielzeug. Erlauben Sie Kindern nicht, mit diesem Artikel zu spielen.







## VORSICHTSMASSNAHMEN BEI DER MONTAGE

1. Nur gemäß dieser Anleitung zusammenbauen. Unsachgemäßer Zusammenbau kann Gefahren schaffen.
2. Tragen Sie ANSI-zugelassene Schutzbrillen und schwere Arbeitshandschuhe während Montage.
3. Halten Sie den Versammlungsbereich sauber und gut beleuchtet.
4. Halten Sie während der Montage unbeteiligte Zuschauer vom Bereich fern.
5. Montieren Sie nicht, wenn Sie müde sind oder unter dem Einfluss von Alkohol, Drogen oder Medikamente.
6. Die Produkteigenschaften gelten für ordnungsgemäß und vollständig montierte Nur Produkte.
7. Weitere Informationen zu den im Folgenden aufgeführten Teilen finden Sie Seiten finden Sie im Montagediagramm dieses Handbuchs. Auspacken und Trennen Sie alle Teile in einem sauberen Arbeitsbereich.
8. Aus Sicherheitsgründen wird empfohlen, diese Hardware von 2 zu installieren Menschen .

### **ANLEITUNG AUFBEWAHREN**





NEIN.	Modell	Länge des Handlaufs (mm)	Anzahl der Kreuze Riegel (Stk.)
1	SSH-1S-80-2	800	2
2	SSH-1S-100-0	1000	0
3	SSH-1S-100-2		2
4	SSH-1S-120-2	1200	2
5	SSH-1S-120-3		3
6	SSH-1S-150-0	1500	0
7	SSH-1S-150-3		3
8	SSH-1S-150-5		5
9	SSH-1S-180-0	1800	0
10	SSH-1S-180-2		2







**Blatt1**

Stückliste						
Kein Name	Bild	MENGE.				
		SSH	SSH	SSH	SSH	SSH
		<small>-1 Sekunden</small>	<small>-1 Sekunden</small>	<small>-1 Sekunden</small>	<small>-1 Sekunden</small>	<small>-1 Sekunden</small>
		-80	-100	-100	-120	-120
		-2	-0	-2	-2	-3
Ein Handlauf		1	1	1	1	1
B	Spalte 	2	2	2	2	2
C	Spalte Kopf 	2	2	2	2	2
D	Schrauben M6*12 	2	2	2	2	2
UND	Schrauben M6*25 	2	2	2	2	2
F	Erweiterung Bolzen 	6	6	6	6	6

G	Dekorativ Abdeckung		2	2	2	2	2
HALLO &J	Querstrebe Montage Zubehör		4 Satz 0	Satz 4	Satz 4	Satz	6 Satz
K	Querstrebe		2	0	2	2	3
M	Schlüssel		1	1	1	1	1
M	Inbusschlüssel 3		1	1	1	1	1
N	Inbusschlüssel 4		1	1	1	1	1
O	Inbusschlüssel 5		1	1	1	1	1
P	Bohrer		1	1	1	1	1

## Blatt 2

Stückliste							
NEIN.	Name	Bild	MENGE.				
			SSH <small>-1 Sekunden</small>	SSH <small>-1 Sekunden</small>	SSH <small>-1 Sekunden</small>	SSH <small>-1 Sekunden</small>	SSH <small>-1 Sekunden</small>
			-150 -0	-150 -3	-150 -5	-180 -0	-180 -2
Ein	Handlauf		1	1	1	1	1
B	Spalte		2	2	2	2	2
C	Spalte Kopf		2	2	2	2	2
D	Schrauben M6*12		2	2	2	2	2

UND	Schrauben M6*25		2	2	2	2	2
F	Erweiterung Bolzen		6	6	6	6	6
G	Dekoratív Abdeckung		2	2	2	2	2
H& <small>ich und J.</small>	Querstrebe Montage Zubehör		0 Satz	6 Satz	10 Satz	0 Satz	4 Satz
K	Querstrebe		0	3	5	0	2
M	Schlüssel		1	1	1	1	1
M	Inbusschlüssel 3		1	1	1	1	1
N	Inbusschlüssel 4		1	1	1	1	1
O	Inbusschlüssel 5		1	1	1	1	1
P	Bohrer		1	1	1	1	1

## Produktmontage

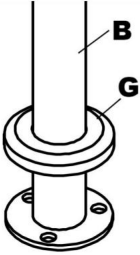
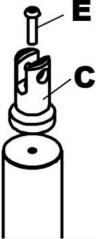
	
<p><b>SCHRITT 1:</b> Setzen Sie die dekorative Abdeckung ein. <b>SCHRITT 2:</b> Verriegeln Sie den Säulenkopf fest.</p>	

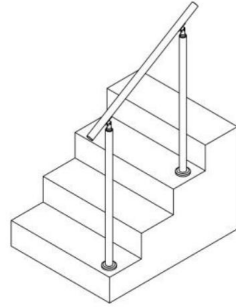
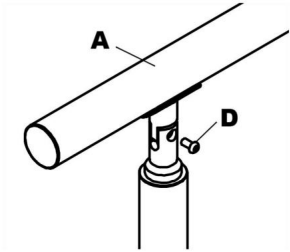

**SCHRITT 3:** Handlauf installieren.

**SCHRITT 4:** Bringen Sie den Handlauf an der Treppe an.

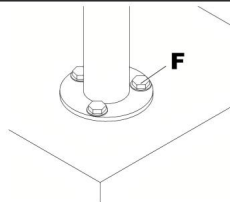
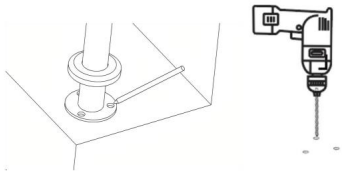

**SCHRITT 5:** Markieren Sie die Installation  
Position und Löcher bohren.

**SCHRITT 6:** Anbringen des Spreizbolzens.

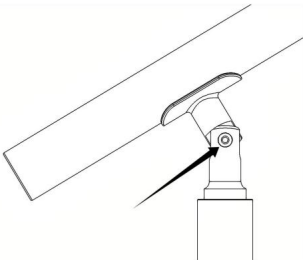

**SCHRITT 7:** Schrauben festziehen.

Wenn das Produkt über Querstangen verfügt, installieren Sie diese auf die gleiche Weise wie bei der Installation von SSH-1S-100-2.

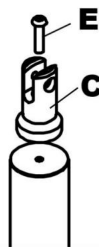
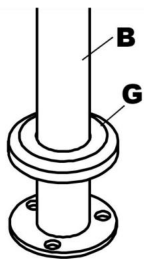

**SCHRITT 1:** Setzen Sie die dekorative Abdeckung ein. **SCHRITT 2:** Verriegeln Sie den Säulenkopf fest.

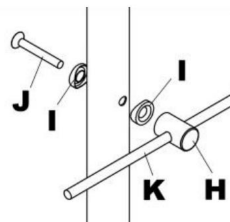
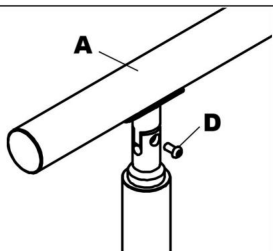

**SCHRITT 3:** Handlauf installieren.

**SCHRITT 4:** Querstrebe montieren

Montage.

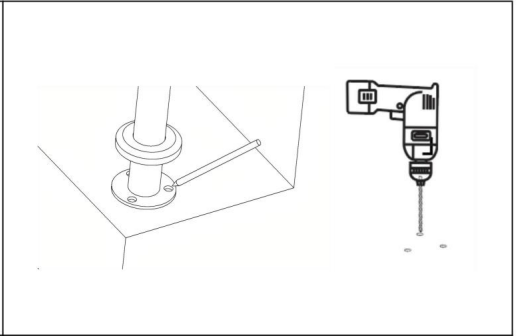
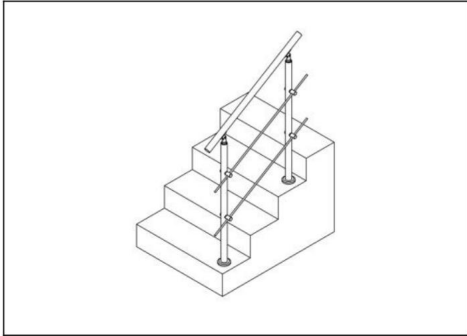

**SCHRITT 5:** Legen Sie den Handlauf auf die Treppe.

**SCHRITT 6:** Markieren Sie den Installationsort und Löcher bohren.

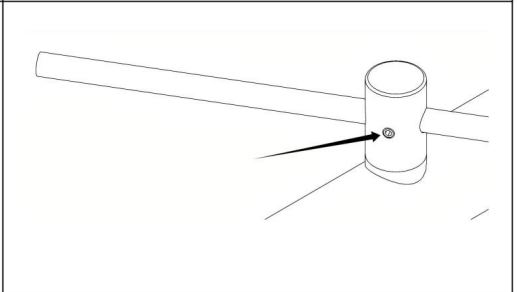
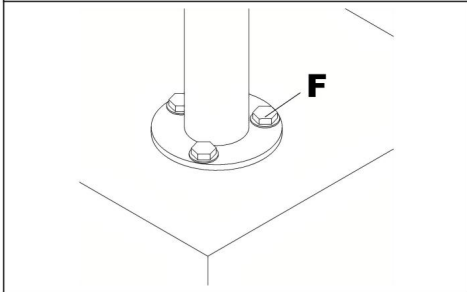

**SCHRITT 7:** Anbringen des Spreizbolzens. **SCHRITT 8:** Festziehen der Stellschrauben.

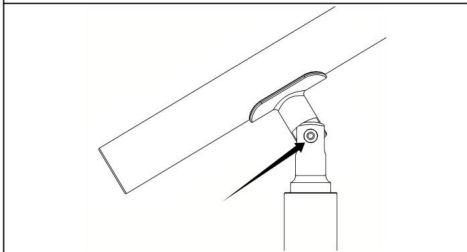

**SCHRITT 9:** Schrauben festziehen.

**Hersteller:** Shanghaimuxinmuyeyouxiangongsi

**Adresse:** Shuangchenglu 803nong11hao1602A-1609shi, baoshanqu, Shanghai  
200000 CN.

**Nach AUS importiert:** SIHAO PTY LTD. 1 ROKEVA STREETEASTWOOD  
NSW 2122 Australien

**Importiert in die USA:** Sanven Technology Ltd. Suite 250, 9166 Anaheim  
Ort, Rancho Cucamonga, CA 91730



YH CONSULTING LIMITED.

C/O YH Consulting Limited Office 147,  
Centurion House, London Road,  
Staines-upon-Thames, Surrey, TW18 4AX

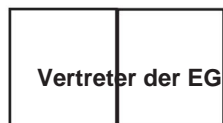

E-CrossStu GmbH

Mainzer Landstr.69,  
60329 Frankfurt am Main.

**VEVOR**<sup>®</sup>

**TOUGH TOOLS, HALF PRICE**

**Technischer Support und E-Garantie-Zertifikat**

**[www.vevor.com/support](http://www.vevor.com/support)**

# **VEVOR<sup>®</sup>**

## **TOUGH TOOLS, HALF PRICE**

Supporto tecnico e certificato di garanzia elettronica [www.vevor.com/support](http://www.vevor.com/support)

### **CORRIMANO IN ACCIAIO INOSSIDABILE**

MODELLO:SSH-1S-80-2 \ SSH-1S-100-0 \ SSH-1S-100-2  
SSH-1S-120-2 \ SSH-1S-120-3 \ SSH-1S-150-0 \ SSH-1S-150-3  
SSH-1S-150-5 \ SSH-1S-180-0 \ SSH-1S-180-2

Continuiamo a impegnarci per fornirvi strumenti a prezzi competitivi.

"Risparmia la metà", "Metà prezzo" o qualsiasi altra espressione simile da noi utilizzata rappresenta solo una stima del risparmio che potresti trarre dall'acquistare determinati strumenti con noi rispetto ai principali marchi più importanti e non significa necessariamente coprire tutte le categorie di strumenti offerti da noi. Ti ricordiamo di verificare attentamente quando effettui un ordine con noi se stai effettivamente risparmiando la metà rispetto ai migliori marchi principali.



# VEVOR<sup>®</sup>

TOUGH TOOLS, HALF PRICE

ACCIAIO INOSSIDABILE  
CORRIMANO

**MODELLO:** SSH-1S-80-2 \ SSH-1S-100-0 \ SSH-1S-100-2 \ SSH-1S-120-2  
SSH-1S-120-3 \ SSH-1S-150-0 \ SSH-1S-150-3 \ SSH-1S-150-5  
SSH-1S-180-0 \ SSH-1S-180-2



**(PS: il numero di barre trasversali: 0ÿ2ÿ3ÿ5.)**

## HO BISOGNO DI AIUTO? CONTATTACI!

Hai domande sul prodotto? Hai bisogno di supporto tecnico? Non esitate a contattarci:

### Supporto

**tecnico e certificato di garanzia elettronica [www.vevor.com/  
support](http://www.vevor.com/support)**

Queste sono le istruzioni originali, leggere attentamente tutte le istruzioni del manuale prima dell'uso. VEVOR si riserva una chiara interpretazione del nostro manuale d'uso. L'aspetto del prodotto sarà soggetto al prodotto ricevuto. Ti preghiamo di perdonarci se non ti informeremo più se sono presenti aggiornamenti tecnologici o software sul nostro pr

## ISTRUZIONI SICURE

**ATTENZIONE:** leggere attentamente le istruzioni e le procedure per operare in sicurezza. In caso contrario si potrebbero causare lesioni gravi.



### AVVERTIMENTO:

1. Prima di utilizzare il corrimano, assicurarsi che il corrimano sia installato saldamente prevenire lesioni personali e incidenti.
2. Quando si utilizza il corrimano, non sovraccaricare il corrimano per evitare rischi personali lesioni o incidenti.
3. Non disegnare, tagliare o utilizzare oggetti appuntiti sul corrimano per evitare danni.
4. Se è necessario smontare il corrimano, seguire i passaggi inversi smontarlo e conservarlo correttamente.
5. Questo prodotto non è un giocattolo. Non permettere ai bambini di giocare con questo oggetto.







## PRECAUZIONI DI MONTAGGIO

1. Montare solo seguendo queste istruzioni. Un assemblaggio improprio può creare pericoli.
2. Indossare occhiali di sicurezza approvati ANSI e guanti da lavoro pesanti durante assemblaggio.
3. Mantenere l'area di assemblaggio pulita e ben illuminata.
4. Tenere gli astanti lontani dall'area durante l'assemblaggio.
5. Non montare in caso di stanchezza o sotto l'effetto di alcol, droghe o farmaco.
6. Le capacità del prodotto si applicano a un assemblaggio corretto e completo solo prodotti.
7. Per ulteriori informazioni riguardanti le parti elencate di seguito pagine, fare riferimento allo schema di assemblaggio di questo manuale. Scartare e separare tutte le parti in un'area di lavoro pulita.
8. Per motivi di sicurezza, si consiglia di installare questo hardware entro 2 persone .

**CONSERVA QUESTE ISTRUZIONI**





NO.	Modello	Lunghezza del corrimano (mm)	No. Di Croce Barre (pezzi)
1SSH-1S-80-2		800	2
2SSH-1S-100-0		1000	0
3SSH-1S-100-2			2
4SSH-1S-120-2		1200	2
5SSH-1S-120-3			3
6SSH-1S-150-0		1500	0
7SSH-1S-150-3			3
8SSH-1S-150-5			5
9SSH-1S-180-0		1800	0
10SSH-1S-180-2			2

## Foglio 1

Elenco delle parti							
Senza nome	Immagine	QUANTITÀ.					
		SSH	SSH	SSH	SSH	SSH	
		-1S -80 -2	-1S -100 -0	-1S -100 -2	-1S -120 -2	-1S -120 -3	
Un corrimano		1	1	1	1	1	
B	Colonna 	2	2	2	2	2	
C	Colonna Testa 	2	2	2	2	2	
D	Vite M6*12 	2	2	2	2	2	
E	Vite M6*25 	2	2	2	2	2	
F	Espansione Bullone 	6	6	6	6	6	

G	Decorativo Copertina		2	2	2	2	2
CIAO &J	Traversa montaggio Accessori		4 serie 0	serie 4	serie 4	serie	6 impostato
	Barra trasversale K		2	0	2	2	3
I	Chiave inglese		1	1	1	1	1
	Chiave esagonale M 3		1	1	1	1	1
N	Chiave esagonale 4		1	1	1	1	1
O	Chiave esagonale 5		1	1	1	1	1
P	Punta da trapano		1	1	1	1	1

## Foglio 2

Elenco delle parti							
NO.	Nome	Immagine	QUANTITÀ.				
			SSH -1S -150 -0	SSH -1S -150 -3	SSH -1S -150 -5	SSH -1S -180 -0	SSH -1S -180 -2
	Un corrimano		1	1	1	1	1
B	Colonna		2	2	2	2	2
C	Colonna Testa		2	2	2	2	2
D	Vite M6*12		2	2	2	2	2

E	Vite M6*25		2	2	2	2	2
F	Espansione Bullone		6	6	6	6	6
G	Decorativo Copertina		2	2	2	2	2
H& I&J	Traversa montaggio Accessori		0 serie	6 serie	10 serie	0 serie	4 serie
	Barra trasversale K		0	3	5	0	2
I	Chiave inglese		1	1	1	1	1
	Chiave esagonale M 3		1	1	1	1	1
N	Chiave esagonale 4		1	1	1	1	1
O	Chiave esagonale 5		1	1	1	1	1
P	Punta da trapano		1	1	1	1	1

### Assemblaggio del prodotto

	
<p><b>FASE 1:</b> inserire la copertura decorativa. <b>FASE 2:</b> Bloccare saldamente la testa della colonna.</p>	

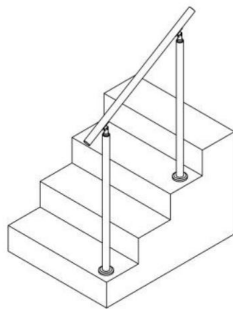
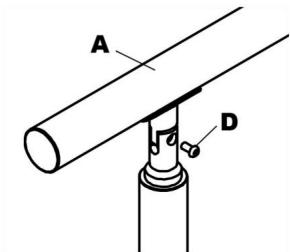

**FASE 3:** Installare il corrimano.

**FASE 4:** Metti il corrimano sulle scale.

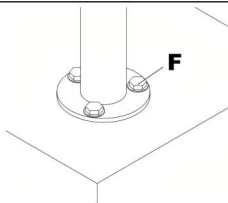
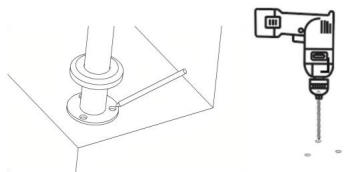

**PASSO 5:** Contrassegnare l'installazione posizione e praticare i fori.

**FASE 6:** Montaggio del bullone di espansione.

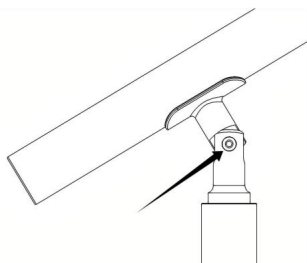

**FASE 7:** Bloccare le viti.

Se il prodotto dispone di barre trasversali, installarle nello stesso modo in cui si installa SSH-1S-100-2.

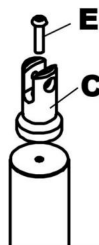
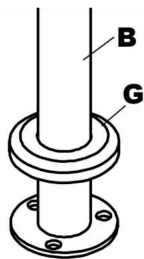

**FASE 1:** inserire la copertura decorativa. **FASE 2:** Bloccare saldamente la testa della colonna.

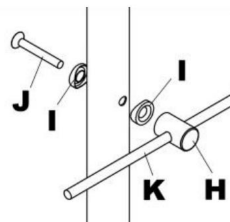
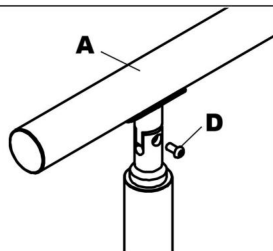

**FASE 3:** Installare il corrimano.

**FASE 4:** assemblare la traversa

assemblaggio.

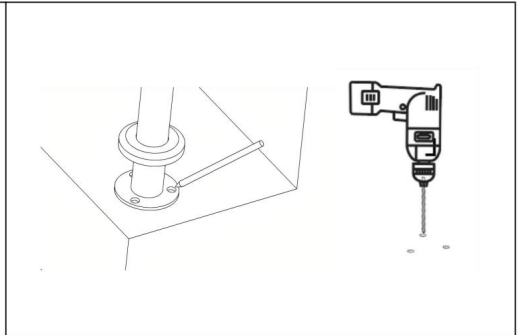
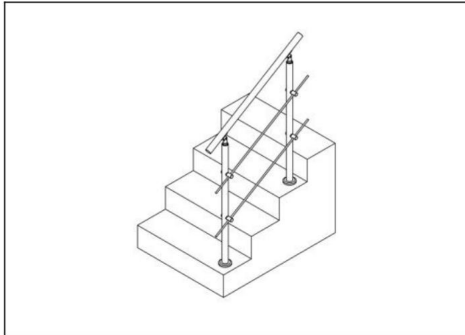

**PASSO 5:** Metti il corrimano sul scale.

**PASSO 6:** Contrassegnare la posizione di installazione e praticare dei fori.

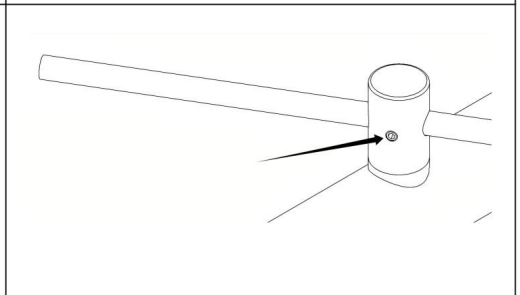
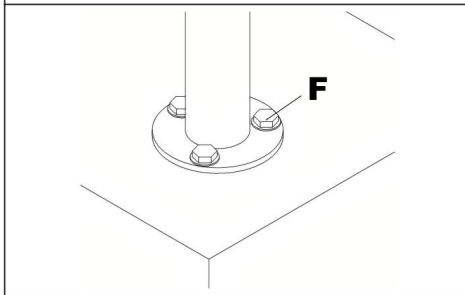

**FASE 7** Montaggio del bullone di espansione. **FASE 8:** Bloccare saldamente le viti di fissaggio.

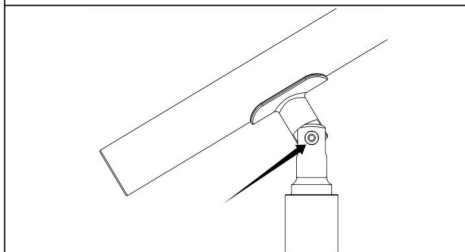

**PASSO 9:** Bloccare le viti.

**Produttore:** Shanghaimuxinmuyeyouxiangongsi

**Indirizzo:** Shuangchenglu 803nong11hao1602A-1609shi, baoshanqu, shanghai  
200000 CN.

**Importato in AUS:** SIHAO PTY LTD. 1 ROKEVA STREETEASTWOOD  
NSW 2122Australia

**Importato negli Stati Uniti:** Sanven Technology Ltd. Suite 250, 9166 Anaheim  
Luogo, Rancho Cucamonga, CA 91730



YH CONSULENZA LIMITATA.

C/O YH Consulting Limited Office 147,  
Centurion House, London Road,  
Staines-upon-Thames, Surrey, TW18 4AX



E-CrossStu GmbH

Mainzer Landstr.69,  
60329 Francoforte sul Meno.

**VEVOR**<sup>®</sup>

**TOUGH TOOLS, HALF PRICE**

**Supporto tecnico e certificato di garanzia  
elettronica [www.vevor.com/support](http://www.vevor.com/support)**

# VEVOR<sup>®</sup>

## TOUGH TOOLS, HALF PRICE

Soporte técnico y certificado de garantía electrónica [www.vevor.com/support](http://www.vevor.com/support)

### PASAMANOS DE ACERO INOXIDABLE

MODELO:SSH-1S-80-2 \ SSH-1S-100-0 \ SSH-1S-100-2  
SSH-1S-120-2 \ SSH-1S-120-3 \ SSH-1S-150-0 \ SSH-1S-150-3  
SSH-1S-150-5 \ SSH-1S-180-0 \ SSH-1S-180-2

Seguimos comprometidos a proporcionarle herramientas a precios competitivos.

"Ahorre a mitad de precio", "A mitad de precio" o cualquier otra expresión similar utilizada por nosotros solo representa una estimación de los ahorros que podría beneficiarse al comprar ciertas herramientas con nosotros en comparación con las principales marcas y no significa necesariamente cubrir todas las categorías de herramientas ofrecidas por nosotros. Le recordamos que, cuando realice un pedido con nosotros, verifique cuidadosamente si realmente está ahorrando la mitad en comparación con las principales marcas.



**VEVOR**<sup>®</sup>  
TOUGH TOOLS, HALF PRICE

ACERO INOXIDABLE  
PRETIL

MODELO: SSH-1S-80-2 \ SSH-1S-100-0 \ SSH-1S-100-2 \ SSH-1S-120-2  
SSH-1S-120-3 \ SSH-1S-150-0\SSH-1S-150-3\SSH-1S-150-5  
SSH-1S-180-0\SSH-1S-180-2



(PD: el número de barras transversales: 0, 2, 3, 5).

¿NECESITAS AYUDA? ¡CONTÁCTENOS!

¿Tiene preguntas sobre el producto? ¿Necesita soporte técnico? No dude en contactarnos:  
Soporte

técnico y certificado de garantía electrónica [www.vevor.com/support](http://www.vevor.com/support)

Estas son las instrucciones originales; lea atentamente todas las instrucciones del manual antes de operar. VEVOR se reserva una interpretación clara de nuestro manual de usuario. La apariencia del producto estará sujeta al producto que recibió. Perdón que no le informaremos nuevamente si hay actualizaciones de tecnología o software en nuestro producto.

## INSTRUCCIONES DE SEGURIDAD

**PRECAUCIÓN:** Lea atentamente las instrucciones y procedimientos para operaciones seguras. De lo contrario, se pueden producir lesiones graves.



### ADVERTENCIA:

1. Antes de usar el pasamanos, asegúrese de que esté instalado de forma segura en prevenir lesiones personales y accidentes.
2. Cuando utilice el pasamano, no lo sobrecargue para evitar daños personales. lesión o accidente.
3. No dibuje, corte ni utilice objetos afilados en el pasamanos para evitar daños.
4. Si necesita desmontar el pasamanos, siga los pasos inversos. desmontarlo y guardarlo correctamente.
5. Este producto no es un juguete. No permita que los niños jueguen con este artículo.







## PRECAUCIONES DE MONTAJE

1. Ensamble únicamente de acuerdo con estas instrucciones. Un montaje inadecuado puede crear peligros.
2. Use gafas de seguridad aprobadas por ANSI y guantes de trabajo resistentes durante asamblea.
3. Mantenga el área de reunión limpia y bien iluminada.
4. Mantenga a las personas transeúntes fuera del área durante el montaje.
5. No se reúna cuando esté cansado o bajo la influencia de alcohol, drogas o medicamento.
6. Las capacidades del producto se aplican a un ensamblaje correcto y completo. productos solamente.
7. Para obtener información adicional sobre las piezas enumeradas a continuación páginas, consulte el diagrama de montaje de este manual. Desarrollar y Separe todas las piezas en un área de trabajo limpia.
8. Por razones de seguridad, se recomienda que este hardware sea instalado por 2 gente .

**GUARDA ESTAS INSTRUCCIONES**





No.	Modelo	Longitud del pasamano (mm)	No. de cruz Barras (piezas)
1SSH-1S-80-2		800	2
2SSH-1S-100-0		1000	0
3SSH-1S-100-2			2
4SSH-1S-120-2		1200	2
5SSH-1S-120-3			3
6SSH-1S-150-0		1500	0
7SSH-1S-150-3			3
8SSH-1S-150-5			5
9SSH-1S-180-0		1800	0
10SSH-1S-180-2			2

## Hoja 1

Lista de							
Sin nombre	Imagen	CANT.					
		SSH	SSH	SSH	SSH	SSH	
		-1S	-1S	-1S	-1S	-1S	
		-80	-100	-100	-120	-120	-3
		-2	-0	-2	-2	-3	
un pasamanos		1	1	1	1	1	
B	Columna 	2	2	2	2	2	
C	Columna Cabeza 	2	2	2	2	2	
D	Tornillo M6*12 	2	2	2	2	2	
Y	Tornillo M6*25 	2	2	2	2	2	
F	Expansión Tornillo 	6	6	6	6	6	

GRABO	Decorativo Cubrir		2	2	2	2	2
HOLA &J	barra transversal montaje accesorios		4 juegos	0 juegos	4 juegos	4 juegos	6 colocar
	Barra transversal K		2	0	2	2	3
I	Llave inglesa		1	1	1	1	1
	Llave hexagonal M 3		1	1	1	1	1
	N llave hexagonal 4		1	1	1	1	1
	O llave hexagonal 5		1	1	1	1	1
PAG	Broca		1	1	1	1	1

## Hoja 2

Lista de							
No.	Nombre	Imagen	CANT.				
			SSH -1S -150 -0	SSH -1S -150 -3	SSH -1S -150 -5	SSH -1S -180 -0	SSH -1S -180 -2
	un pasamanos		1	1	1	1	1
B	Columna		2	2	2	2	2
C	Columna Cabeza		2	2	2	2	2
D	Tornillo M6*12		2	2	2	2	2

Y	Tornillo M6*25		2	2	2	2	2
F	Expansión Tornillo		6	6	6	6	6
GRAND	Decorativo Cubrir		2	2	2	2	2
H& I&J	barra transversal montaje accesorios		0 conjunto	6 conjunto	10 conjunto	0 conjunto	4 conjunto
	Barra transversal K		0	3	5	0	2
I	Llave inglesa		1	1	1	1	1
	Llave hexagonal M 3		1	1	1	1	1
	N llave hexagonal 4		1	1	1	1	1
	O llave hexagonal 5		1	1	1	1	1
PAG	Broca		1	1	1	1	1

## Montaje del producto

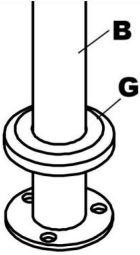
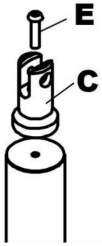
	
<p>PASO 1: Coloque la cubierta decorativa. PASO 2: Bloquee firmemente el cabezal de la columna.</p>	

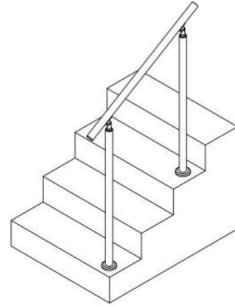
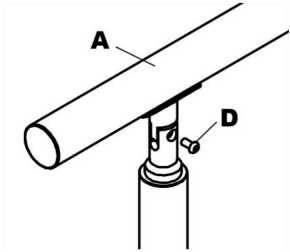

PASO 3: Instale el pasamanos.

PASO 4: Coloque el pasamanos en las escaleras.

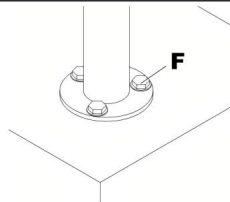
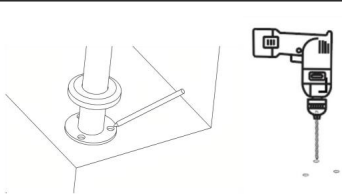

PASO 5: Marque la instalación  
ubicación y taladre los agujeros.

PASO 6: Montaje del perno de expansión.

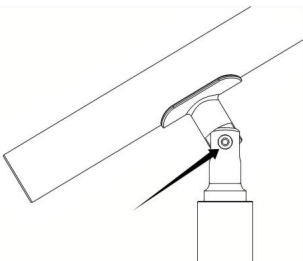

PASO 7: Bloquee los tornillos.

Si el producto tiene algunas barras transversales, instélaslas de la misma manera que instala SSH-1S-100-2.

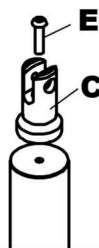
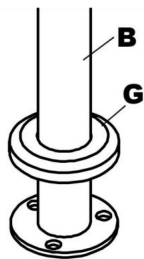

PASO 1: Coloque la cubierta decorativa. PASO 2: Bloquee firmemente el cabezal de la columna.

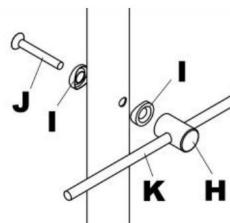
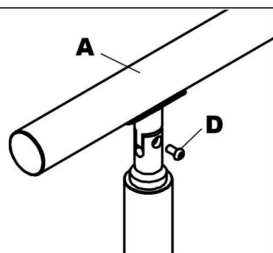

PASO 3: Instale el pasamanos.

PASO 4: Ensamble la barra transversal  
asamblea.

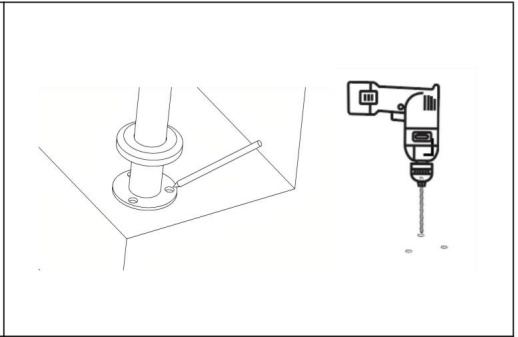
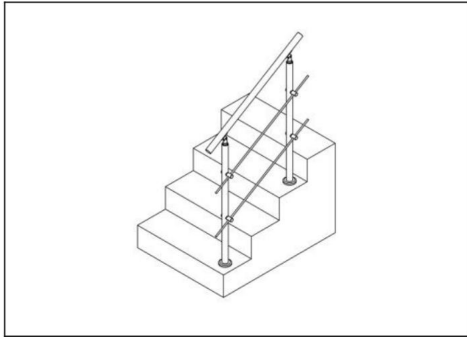

PASO 5: Coloque el pasamanos en el  
escaleras.

PASO 6: Marque la ubicación de instalación  
y taladrez agujeros.

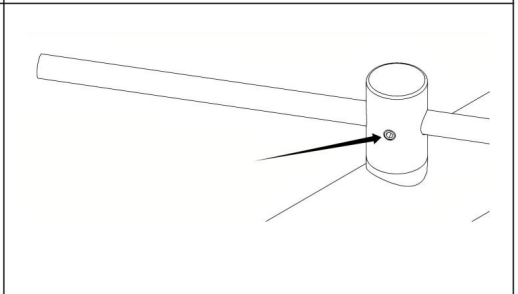
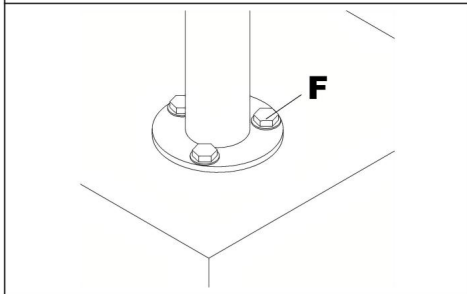

PASO 7: Montaje del perno de expansión. PASO 8: Bloquee firmemente los tornillos fijados.

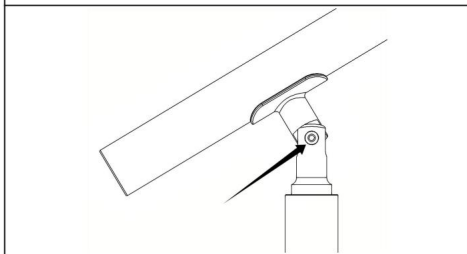

PASO 9: Bloquee los tornillos.

Fabricante: Shanghaimuxinmuyeyouxiangongsi

Dirección: Shuangchenglu 803nong11hao1602A-1609shi, baoshanqu, shanghai  
200000 CN.

Importado a AUS: SIHAO PTY LTD. 1 ROKEVA CALLE ASTWOOD

Nueva Gales del Sur 2122 Australia

Importado a EE. UU.: Sanven Technology Ltd. Suite 250, 9166 Anaheim

Lugar, Rancho Cucamonga, CA 91730

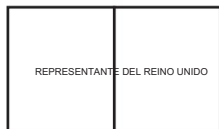

YH CONSULTING LIMITADO.

C/O YH Consulting Limited Oficina 147,  
Centurion House, London Road,  
Staines-upon-Thames, Surrey, TW18 4AX

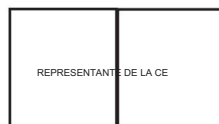

E-CrossStu GmbH

Mainzer Landstr.69,  
60329 Fráncfort del Meno.

**VEVOR**®

**TOUGH TOOLS, HALF PRICE**

Soporte técnico y certificado de garantía  
electrónica [www.vevor.com/support](http://www.vevor.com/support)

# VEVOR<sup>®</sup>

## TOUGH TOOLS, HALF PRICE

Wsparcie techniczne i certyfikat e-gwarancji [www.vevor.com/support](http://www.vevor.com/support)

### PORĘCZ ZE STALI NIERDZIEWNEJ

MODEL:SSH-1S-80-2 \ SSH-1S-100-0 \ SSH-1S-100-2  
SSH-1S-120-2 \ SSH-1S-120-3 \ SSH-1S-150-0 \ SSH-1S-150-3  
SSH-1S-150-5 \ SSH-1S-180-0 \ SSH-1S-180-2

Nadal dokładamy wszelkich starań, aby zapewnić Państwu narzędzia w konkurencyjnej cenie. „Zaoszczędź połowę”, „połowa ceny” lub inne podobne wyrażenia używane przez nas przedstawiają jedynie szacunkową oszczędność, jaką możesz zyskać kupując u nas określone narzędzia w porównaniu z głównymi najlepszymi markami i niekoniecznie oznaczają uwzględnienie wszystkich kategorii oferowanych narzędzi przez nas. Przypominamy, aby podczas składania zamówienia u nas dokładnie sprawdzić, czy rzeczywiście oszczędzasz połowę w porównaniu z czołowymi markami.



**VEVOR**<sup>®</sup>  
TOUGH TOOLS, HALF PRICE

STAL NIERDZEWNA  
PORĘCZ

MODEL: SSH-1S-80-2 \ SSH-1S-100-0 \ SSH-1S-100-2 \ SSH-1S-120-2  
SSH-1S-120-3 \ SSH-1S-150-0\SSH-1S-150-3\SSH-1S-150-5  
SSH-1S-180-0 \ SSH-1S-180-2



(PS: Liczba poprzeczek: 0235.)

POTRZEBUJĘ POMOCY? SKONTAKTUJ SIĘ Z NAMI!

Masz pytania dotyczące produktu? Potrzebujesz wsparcia technicznego? Prosimy o kontakt:  
Wsparcie

techniczne i certyfikat e-gwarancji [www.vevor.com/support](http://www.vevor.com/support)

To jest oryginalna instrukcja. Przed przystąpieniem do obsługi prosimy o dokładne zapoznanie się ze wszystkimi instrukcjami. VEVOR zastrzega sobie jasną interpretację naszej instrukcji obsługi. Wygląd produktu zależy od produktu, który otrzymałeś. Proszę wybaczyć nam, że nie będziemy ponownie informować Państwa, jeśli pojawią się jakieś aktualizacje technologii lub oprogramowania naszego produktu.

## BEZPIECZNE INSTRUKCJE

**UWAGA:** Przeczytaj uważnie instrukcje i procedury dotyczące bezpiecznej obsługi.

Niezastosowanie się do tego może spowodować poważne obrażenia.



### OSTRZEŻENIE:

1. Przed użyciem poręczy upewnij się, że poręcz jest bezpiecznie zamontowana zapobiegać obrażeniom ciała i wypadkom.
2. Podczas korzystania z poręczy nie przeciążaj poręczy, aby uniknąć obrażeń osobistych uraz lub wypadek.
3. Nie rysuj, nie przecinaj ani nie używaj ostrych przedmiotów na poręczy, aby uniknąć uszkodzenia.
4. Jeżeli zachodzi potrzeba demontażu poręczy, wykonaj czynności w odwrotnej kolejności zdemontować i prawidłowo przechowywać.
5. Ten produkt nie jest zabawką. Nie pozwalaj dzieciom bawić się tym przedmiotem.







## ŚRODKI OSTROŻNOŚCI PRZY MONTAŻU

1. Montaż wyłącznie według niniejszej instrukcji. Nieprawidłowy montaż może stwarzać zagrożenia.
2. Podczas pracy nosić zatwierdzone przez ANSI okulary ochronne i wytrzymałe rękawice robocze montaż.
3. Utrzymuj miejsce montażu w czystości i dobrze oświetlone.
4. Podczas montażu trzymaj osoby postronne z dala od obszaru.
5. Nie montuj się będąc zmęczonym, pod wpływem alkoholu, narkotyków lub narkotyków lek.
6. Możliwości produktu dotyczą prawidłowo i całkowicie zmontowanego tylko produkty.
7. Dodatkowe informacje dotyczące części wymienionych poniżej stron, zapoznaj się ze schematem montażu w tej instrukcji. Rozpakuj i oddziel wszystkie części w czystym miejscu pracy.
8. Ze względów bezpieczeństwa zaleca się instalację tego sprzętu przez 2 osoby ludzie .

**ZACHOWAJ TE INSTRUKCJE**





NIE.	Model	Długość poręczy (mm)	Nr krzyża Pręty (szt.)
1	SSH-1S-80-2	800	2
2	SSH-1S-100-0	1000	0
3	SSH-1S-100-2		2
4	SSH-1S-120-2	1200	2
5	SSH-1S-120-3		3
6	SSH-1S-150-0	1500	0
7	SSH-1S-150-3		3
8	SSH-1S-150-5		5
9	SSH-1S-180-0	1800	0
10	SSH-1S-180-2		2

## Arkusz 1

Lista części							
Bez nazwy	Zdjęcie	ILOŚĆ.					
		SSH -1 S -80 -2	SSH -1 S -100 -0	SSH -1 S -100 -2	SSH -1 S -120 -2	SSH -1 S -120 -3	
Poręcz		1	1	1	1	1	
B	Kolumna 	2	2	2	2	2	
C	Kolumna Głowa 	2	2	2	2	2	
D	Śruba M6*12 	2	2	2	2	2	
I	Śruba M6*25 	2	2	2	2	2	
F	Ekspansja Śruba 	6	6	6	6	6	

G	Dekoracyjny Okładka		2	2	2	2	2
CZEŚĆ &J	Poprzeczka montowanie Akcesoria		4 zestawy	0 zestawów	4 zestawów	4 zestawów	6 ustawić
	Poprzeczka K		2	0	2	2	3
L	Klucz		1	1	1	1	1
M	Klucz sześciokątny 3		1	1	1	1	1
N	Klucz sześciokątny 4		1	1	1	1	1
O	Klucz sześciokątny 5		1	1	1	1	1
P	Wiertło		1	1	1	1	1

## Arkusz 2

Lista części							
NIE.	Nazwa	Zdjęcie	ILOŚĆ.				
			SSH -1 S -150 -0	SSH -1 S -150 -3	SSH -1 S -150 -5	SSH -1 S -180 -0	SSH -1 S -180 -2
	Porecz		1	1	1	1	1
B	Kolumna		2	2	2	2	2
C	Kolumna Głowa		2	2	2	2	2
D	Śruba M6*12		2	2	2	2	2

I	Śruba M6*25		2	2	2	2	2
F	Ekspansja Śruba		6	6	6	6	6
G	Dekoracyjny Okładka		2	2	2	2	2
H& I&J	Poprzeczka montowanie Akcesoria		0 zestawów	6 zestawów	10 zestawów	0 zestawów	4 zestawów
	Poprzeczka K		0	3	5	0	2
L	Klucz		1	1	1	1	1
M	Klucz sześciokątny 3		1	1	1	1	1
N	Klucz sześciokątny 4		1	1	1	1	1
O	Klucz sześciokątny 5		1	1	1	1	1
P	Wiertło		1	1	1	1	1

## Montaż produktu

	
KROK 1: Załóż ozdobną osłonę. KROK 2: Mocno zablokuj głowicę kolumny.	

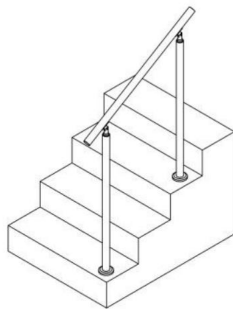
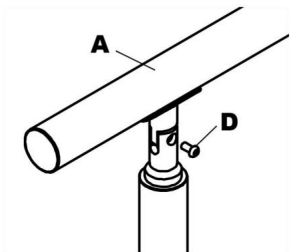

KROK 3: Zamontuj poręcz.

KROK 4: Połóż poręcz na schodach.

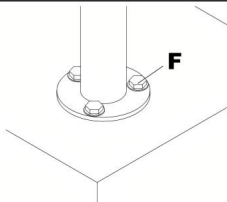
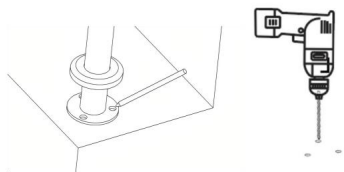

KROK 5: Zaznacz instalację  
lokalizację i wywierć otwory.

KROK 6: Montaż śruby rozporowej.

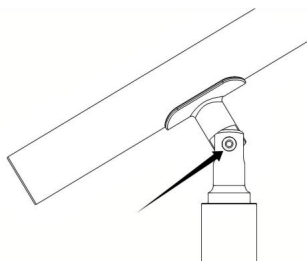

KROK 7: Zablokuj śruby.

Jeśli produkt ma poprzeczki, zainstaluj je w taki sam sposób, jak instalując SSH-1S-100-2.

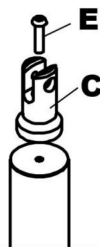
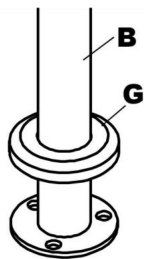

KROK 1: Załóż ozdobną osłonę. KROK 2: Mocno zablokuj głowicę kolumny.

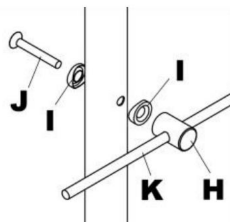
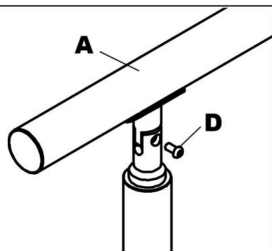

KROK 3: Zamontuj poręcz.

KROK 4: Zamontuj poprzeczkę  
montaż.

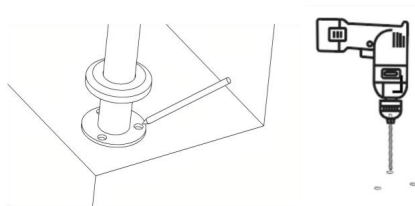
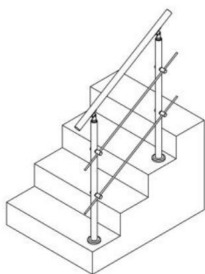

KROK 5: Połóż poręcz na schody.

KROK 6: Zaznacz miejsce instalacji i wywierć otwory.

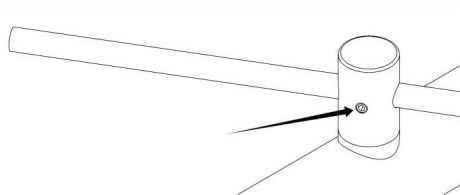
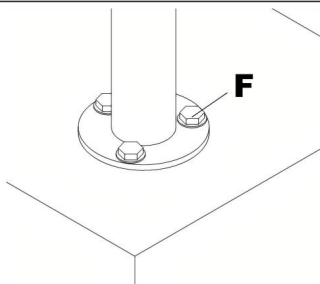

KROK 7: Montaż śruby rozporowej. KROK 8: Zablokuj mocno dokręcone śruby.

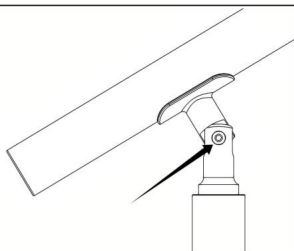

KROK 9: Zablokuj śruby.

Producent: Shanghaimuxinmuyeyouxiangongsi

Adres: Shuangchenglu 803nong11hao1602A-1609shi, baoshanqu, szanghaj  
200000 CN.

Import do AUS: SIHAO PTY LTD. 1 ROKEVA STREETEASTWOOD

Nowa Południowa Walia 2122 Australia

Import do USA: Sanven Technology Ltd. Suite 250, 9166 Anaheim  
Place, Rancho Cucamonga, Kalifornia 91730



YH CONSULTING SPÓŁKA Z OGRANICZONĄ ODPOWIEDZIALNOŚCIĄ.

C/O YH Consulting Limited Office 147,  
Centurion House, London Road,  
Staines-upon-Thames, Surrey, TW18 4AX

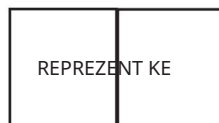

E-CrossStu GmbH  
Mainzer Landstr.69,  
60329 Frankfurt nad Menem.

**VEVOR<sup>®</sup>**

**TOUGH TOOLS, HALF PRICE**

Wsparcie techniczne i certyfikat e-gwarancji

[www.vevor.com/support](http://www.vevor.com/support)

# VEVOR<sup>®</sup>

## TOUGH TOOLS, HALF PRICE

Technische ondersteuning en e-garantiecertificaat [www.vevor.com/support](http://www.vevor.com/support)

### ROESTVRIJ STALEN LEUNING

MODEL:SSH-1S-80-2 \ SSH-1S-100-0 \ SSH-1S-100-2  
SSH-1S-120-2 \ SSH-1S-120-3 \ SSH-1S-150-0 \ SSH-1S-150-3  
SSH-1S-150-5 \ SSH-1S-180-0 \ SSH-1S-180-2

We blijven ons inzetten om u gereedschap tegen een concurrerende prijs te bieden.

'Bespaar de helft', 'Halve prijs' of andere soortgelijke uitdrukkingen die door ons worden gebruikt vertegenwoordigen slechts een schatting van de besparingen die u zou kunnen profiteren als u bepaalde gereedschappen bij ons koopt in vergelijking met de grote topmerken en betekenen niet noodzakelijkerwijs dat ze alle aangeboden categorieën gereedschappen dekken. door ons. U wordt er vriendelijk aan herinnerd om bij het plaatsen van een bestelling bij ons zorgvuldig te verifiëren of u daadwerkelijk de helft bespaart in vergelijking met de grote topmerken.



# VEVOR<sup>®</sup>

TOUGH TOOLS, HALF PRICE

ROESTVRIJ STAAL  
LEUNING

**MODEL:** SSH-1S-80-2 \ SSH-1S-100-0 \ SSH-1S-100-2 \ SSH-1S-120-2  
SSH-1S-120-3\SSH-1S-150-0\SSH-1S-150-3\SSH-1S-150-5  
SSH-1S-180-0\SSH-1S-180-2



**(PS:** Het aantal dwarsbalken: 0,2,3,5.)

**HULP NODIG? NEEM CONTACT MET ONS OP!**

Heeft u productvragen? Technische ondersteuning nodig? Neem gerust contact met ons op:

**Technische**

**ondersteuning en e-garantiecertificaat [www.vevor.com/  
support](http://www.vevor.com/support)**

Dit is de originele instructie. Lees alle handleidingen zorgvuldig door voordat u ermee aan de slag gaat. VEVOR behoudt zich een duidelijke interpretatie van onze gebruikershandleiding voor. Het uiterlijk van het product is afhankelijk van het product dat u heeft ontvangen. Vergeef ons alstublieft dat we u niet opnieuw informeren als er technologie- of software-updates zijn voor ons product.

## VEILIGE INSTRUCTIES

**LET OP:** Lees zorgvuldig de instructies en procedures voor veilig gebruik.

Als u dit niet doet, kan dit leiden tot ernstig letsel.



### **WAARSCHUWING:**

1. Voordat u de leuning gebruikt, moet u ervoor zorgen dat de leuning stevig is geïnstalleerd persoonlijk letsel en ongevallen voorkomen.
2. Wanneer u de leuning gebruikt, overbelast de leuning dan niet om persoonlijk letsel te voorkomen letsel of ongeval.
3. Teken, snij of gebruik geen scherpe voorwerpen op de leuning om schade te voorkomen.
4. Als u de leuning moet demonteren, volgt u de stappen in omgekeerde volgorde demonteren en op de juiste manier opbergen.
5. Dit product is geen speelgoed. Laat kinderen niet met dit artikel spelen.







## MONTAGEVOORZORGSMAATREGELEN

1. Monteer uitsluitend volgens deze instructies. Onjuiste montage kan gevaren creëren.
2. Draag tijdens de werkzaamheden een ANSI-goedgekeurde veiligheidsbril en stevige werkhandschoenen montage.
3. Houd de verzamelplaats schoon en goed verlicht.
4. Houd omstanders tijdens de montage uit de buurt.
5. Niet monteren als u moe bent of onder invloed bent van alcohol, drugs of medicatie.
6. Productmogelijkheden zijn van toepassing op correcte en volledige montage alleen producten.
7. Voor aanvullende informatie over de hieronder genoemde onderdelen pagina's verwijzen wij u naar het montageschema van deze handleiding. Uitpakken en scheid alle onderdelen in een schone werkomgeving.
8. Om veiligheidsredenen wordt aanbevolen deze hardware vóór 2 uur te installeren mensen .

### **BEWAAR DEZE INSTRUCTIES**





Nee.	Model	Lengte van leuning (mm)	Nr. Van Kruis Staven (stuks)
1	SSH-1S-80-2	800	2
2	SSH-1S-100-0	1000	0
3	SSH-1S-100-2		2
4	SSH-1S-120-2	1200	2
5	SSH-1S-120-3		3
6	SSH-1S-150-0	1500	0
7	SSH-1S-150-3		3
8	SSH-1S-150-5		5
9	SSH-1S-180-0	1800	0
10	SSH-1S-180-2		2

**Blad 1**

Onderdelen lijst							
Geen naam	naam	Afbeelding	AANTAL.				
			SSH	SSH	SSH	SSH	SSH
			-1S -80 -2	-1S -100 -0	-1S -100 -2	-1S -120 -2	-1S -120 -3
Een	leuning		1	1	1	1	1
B	Kolom		2	2	2	2	2
C	Kolom Hoofd		2	2	2	2	2
D	Schroef M6*12		2	2	2	2	2
EN	Schroef M6*25		2	2	2	2	2
F	Uitbreiding Bout		6	6	6	6	6

G	Decoratief Omslag		2	2	2	2	2
HOI & J	Dwarsbalk montage accessoires		4 ingesteld	0 ingesteld	4 ingesteld	4 ingesteld	6 set
K	Dwarsbalk		2	0	2	2	3
L	Moersleutel		1	1	1	1	1
M	Inbussleutel 3		1	1	1	1	1
N	Inbussleutel 4		1	1	1	1	1
O	Inbussleutel 5		1	1	1	1	1
P	Boor		1	1	1	1	1

## Blad 2

Onderdelen lijst								
Nee.	Naam	Afbeelding	AANTAL.					
			SSH -1S -150 -0	SSH -1S -150 -3	SSH -1S -150 -5	SSH -1S -180 -0	SSH -1S -180 -2	
Een	leuning		1	1	1	1	1	
B	Kolom		2	2	2	2	2	
C	Kolom Hoofd		2	2	2	2	2	
D	Schroef M6*12		2	2	2	2	2	

EN	Schroef M6*25		2	2	2	2	2
F	Uitbreiding Bout		6	6	6	6	6
G	Decoratief Omslag		2	2	2	2	2
H& Ik&J	Dwarsbalk montage accessoires		0 set 6 set 10 set	0 set 4 set			
K	Dwarsbalk		0	3	5	0	2
L	Moersleutel		1	1	1	1	1
M	Inbussleutel 3		1	1	1	1	1
N	Inbussleutel 4		1	1	1	1	1
O	Inbussleutel 5		1	1	1	1	1
P	Boor		1	1	1	1	1

## Productmontage

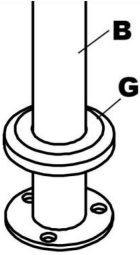
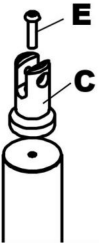
	
<b>STAP 1:</b> Plaats een decoratieve hoed.	<b>STAP 2:</b> Vergrendel de kolomkop stevig.

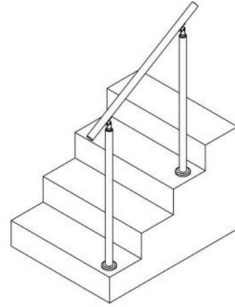
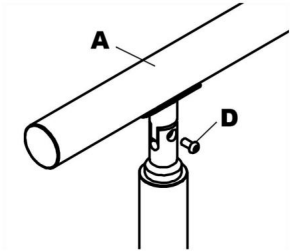

**STAP 3:** Installeer de leuning.

**STAP 4:** Plaats de leuning op de trap.

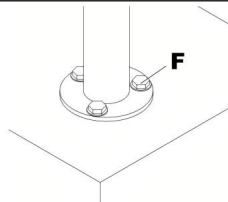
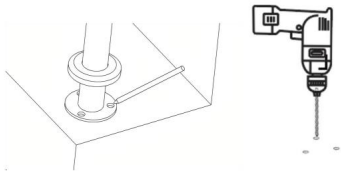

**STAP 5:** Markeer de installatie  
plaatsen en gaten boren.

**STAP 6:** Expansiebout monteren.

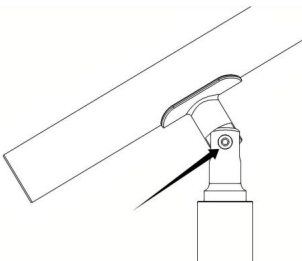

**STAP 7:** Borgschroeven.

ÿ Als het product dwarsbalken heeft, installeer deze dan op dezelfde manier als bij het installeren van SSH-1S-100-2.

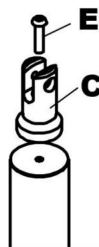
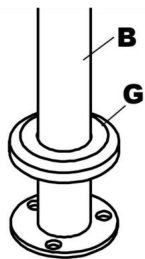

**STAP 1:** Plaats een decoratieve hoed. **STAP 2:** Vergrendel de kolomkop stevig.

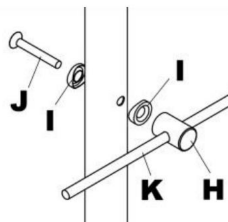
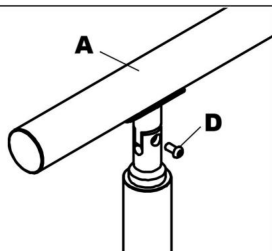

**STAP 3:** Installeer de leuning.

**STAP 4:** Monteer de dwarsbalk montage.

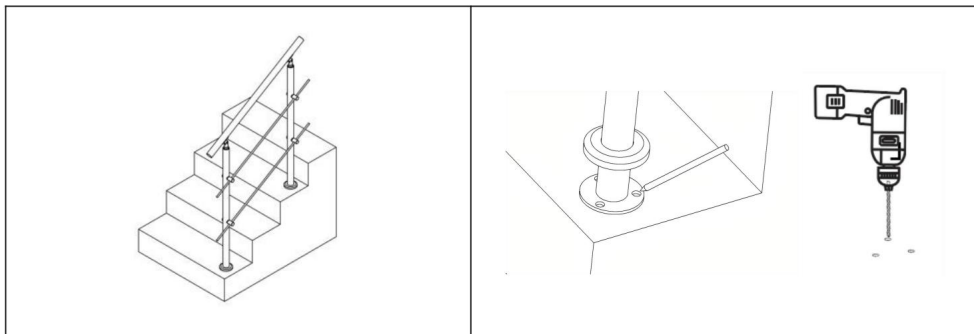

**STAP 5:** Plaats de leuning op de trap.

**STAP 6:** Markeer de installatielocatie en gaten boren.

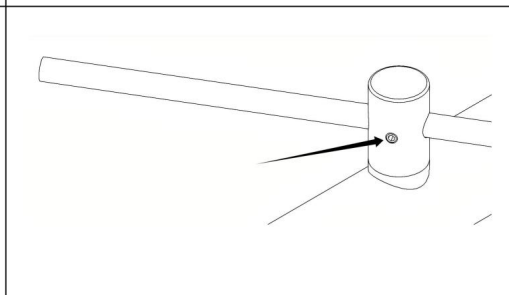
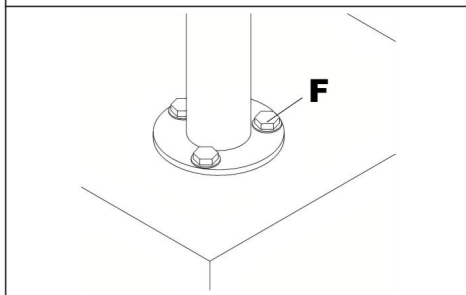

**STAP 7:** Expansiebout monteren. **STAP 8:** Zet de stelschroeven stevig vast.

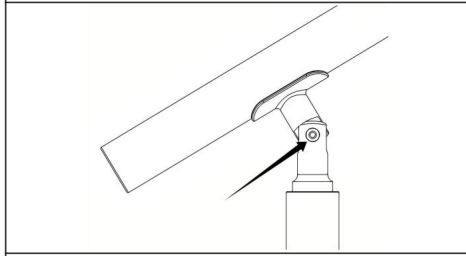

**STAP 9:** Borgschroeven.



**Fabrikant:** Shanghaimuxinmuyeyouxiangongsi

**Adres:** Shuangchenglu 803nong11hao1602A-1609shi, baoshanqu, shanghai  
200000 CN.

**Geïmporteerd naar AUS:** SIHAO PTY LTD. 1 ROKEVA STREETEASTWOOD  
NSW 2122 Australië

**Geïmporteerd in de VS:** Sanven Technology Ltd. Suite 250, 9166 Anaheim  
Plaats, Rancho Cucamonga, CA 91730



YH CONSULTING LIMITED.

C/O YH Consulting Limited Office 147,  
Centurion House, London Road,  
Staines-upon-Thames, Surrey, TW18 4AX



E-CrossStu GmbH

Mainzer Landstr.69,  
60329 Frankfurt am Main.

**VEVOR**®

**TOUGH TOOLS, HALF PRICE**

Technische ondersteuning en e-  
garantiecertificaat [www.vevor.com/support](http://www.vevor.com/support)

# **VEVOR<sup>®</sup>**

## **TOUGH TOOLS, HALF PRICE**

Teknisk support och e-garanticertifikat [www.vevor.com/support](http://www.vevor.com/support)

### **ROSTFRITT STÅL RÄKKE**

MODELL:SSH-1S-80-2 \ SSH-1S-100-0 \ SSH-1S-100-2  
SSH-1S-120-2 \ SSH-1S-120-3 \ SSH-1S-150-0 \ SSH-1S-150-3  
SSH-1S-150-5 \ SSH-1S-180-0 \ SSH-1S-180-2

Vi fortsätter att vara engagerade i att ge dig verktyg till konkurrenskraftiga priser. "Spara hälften", "halva priset" eller andra liknande uttryck som används av oss representerar bara en uppskattning av besparingar du kan dra nytta av att köpa vissa verktyg hos oss jämfört med de stora toppmärkena och betyder inte nödvändigtvis att täcka alla kategorier av verktyg som erbjuds av oss. Du påminns vänligen om att noggrant kontrollera när du gör en beställning hos oss om du faktiskt sparar hälften i jämförelse med de främsta stora varumärkena.



# VEVOR®

TOUGH TOOLS, HALF PRICE

ROSTFRITT STÅL  
LEDSTÅNG

**MODELL:** SSH-1S-80-2 \ SSH-1S-100-0 \ SSH-1S-100-2 \ SSH-1S-120-2  
SSH-1S-120-3 \ SSH-1S-150-0\SSH-1S-150-3\SSH-1S-150-5  
SSH-1S-180-0 \ SSH-1S-180-2



**(PS: Antalet korsstaplar: 0, 2, 3, 5.)**

## BEHÖVS HJÄLP? KONTAKTA OSS!

Har du produktfrågor? Behöver du teknisk support? Kontakta oss gärna: **Teknisk support och e-garanticertifikat [www.vevor.com/support](http://www.vevor.com/support)**

Detta är den ursprungliga instruktionen, läs alla instruktioner noggrant innan du använder den. VEVOR reserverar sig för en tydlig tolkning av vår användarmanual. Utseendet på produkten är beroende av den produkt du fått. Ursäkta oss att vi inte kommer att informera dig igen om det finns någon teknik eller mjukvaruuppdateringar på vår produkt.

## SÄKERHETSINSTRUKTIONER

**VARNING:** Läs noggrant instruktionerna och procedurerna för säker användning. Underlåtenhet att göra det kan resultera i allvarliga skador.



1. Innan du använder räcket, se till att räcket är säkert monterat på förebygga personskador och olyckor.
2. När du använder ledstången, överbelasta inte ledstången för att undvika personlig skada eller olycka.
3. Dra, skär eller använd inte vassa föremål på ledstången för att undvika skador.
4. Om du behöver ta isär ledstången, följ de omvända stegen att demontera och förvara den på rätt sätt.
5. Denna produkt är inte en leksak. Tillåt inte barn att leka med detta föremål.







## FÖRSIKTIGHETSÅTGÄRDER FÖR MONTERING







1. Montera endast enligt dessa instruktioner. Felaktig montering kan skapa faror.
2. Bär ANSI-godkända skyddsglasögon och kraftiga arbetshandskar under hopsättning.
3. Håll monteringsområdet rent och väl upplyst.
4. Håll åskådare borta från området under monteringen.
5. Sätt inte ihop när du är trött eller påverkad av alkohol, droger eller medicin.
6. Produktens kapacitet gäller för korrekt och fullständigt monterad endast produkter.
7. För ytterligare information om delarna som listas nedan sidorna, se monteringsdiagrammet i denna manual. Packa upp och separera alla delar i ett rent arbetsområde.
8. Av säkerhetsskäl rekommenderas denna hårdvara att installeras senast 2 människor .

## SPARA DESSA INSTRUKTIONER





Nej.	Modell	Ledstångens längd (mm)	Nr av kors Barer (st)
1	SSH-1S-80-2	800	2
2	SSH-1S-100-0	1000	0
3	SSH-1S-100-2		2
4	SSH-1S-120-2	1200	2
5	SSH-1S-120-3		3
6	SSH-1S-150-0	1500	0
7	SSH-1S-150-3		3
8	SSH-1S-150-5		5
9	SSH-1S-180-0	1800	0
10	SSH-1S-180-2		2









**Blad 1**

Dellista							
Inget namn	Bild	ANTAL.					
		SSH -1S -80 -2	SSH -1S -100 -0	SSH -1S -100 -2	SSH -1S -120 -2	SSH -1S -120 -3	
Ett ledstång		1	1	1	1	1	
B	Kolumn 	2	2	2	2	2	
C	Kolumn Huvud 	2	2	2	2	2	
D	Skruva M6*12 	2	2	2	2	2	
OCH	Skruva M6*25 	2	2	2	2	2	
F	Expansion Bult 	6	6	6	6	6	

G	Dekorativ Omslag		2	2	2	2	2
HEJ & J	Tvärstång montering Tillbehör		4 set	0 set	4 set	4 set	6 uppsättning
K	Cross Bar		2	0	2	2	3
L	Rycka		1	1	1	1	1
M	sexkantsnyckel 3		1	1	1	1	1
N	sexkantsnyckel 4		1	1	1	1	1
O	Insexnyckel 5		1	1	1	1	1
P	Borr		1	1	1	1	1

## Blad 2

Dellista							
Nej.	namn	Bild	ANTAL.				
			SSH -1S -150 -0	SSH -1S -150 -3	SSH -1S -150 -5	SSH -1S -180 -0	SSH -1S -180 -2
	Ett ledstång		1	1	1	1	1
B	Kolumn		2	2	2	2	2
C	Kolumn Huvud		2	2	2	2	2
D	Skruva M6*12		2	2	2	2	2

och	Skruva M6*25		2	2	2	2	2
F	Expansion Bult		6	6	6	6	6
G	Dekorativ Omslag		2	2	2	2	2
H& I J	Tvärstång montering Tillbehör		0 set 6 set 10 set 0 set 4 set				
K	Cross Bar		0	3	5	0	2
L	Rycka		1	1	1	1	1
M	sexkantsnyckel 3		1	1	1	1	1
N	sexkantsnyckel 4		1	1	1	1	1
O	Insexnyckel 5		1	1	1	1	1
P	Borr		1	1	1	1	1

## Produktmontering

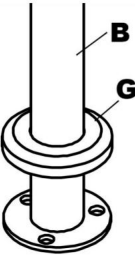
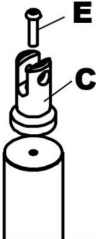
	
<b>STEG 1:</b> Sätt i det dekorativa höljet.	<b>STEG 2:</b> Lås pelarhuvudet ordentligt.

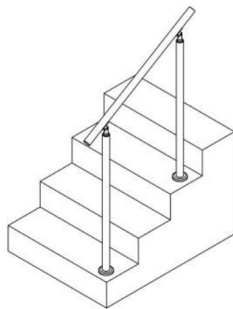
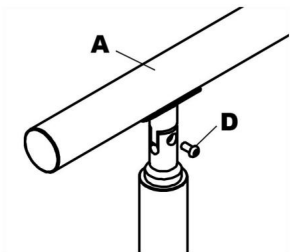

**STEG 3:** Installera ledstång.

**STEG 4:** Sätt ledstången på trappan.

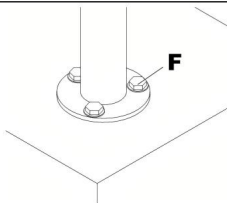
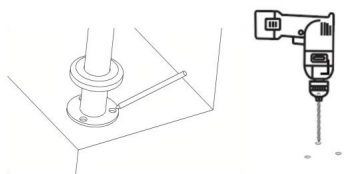

**STEG 5:** Markera installationen  
plats och borra hål.

**STEG 6:** Montera expansionsbult.

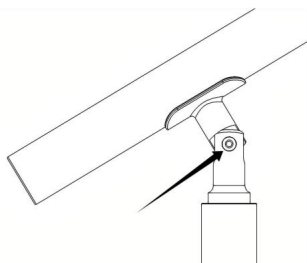

**STEG 7:** Låsskruvar.

Om produkten har några tvärstänger, installera dem på samma sätt som när du installerar SSH-1S-100-2.

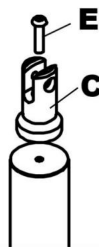
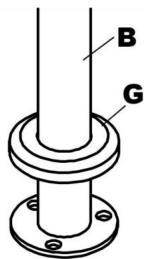

**STEG 1:** Sätt i det dekorativa höljet. **STEG 2:** Läs pelarhuvudet ordentligt.

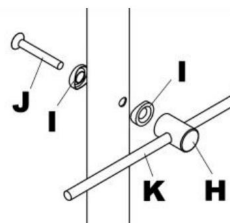
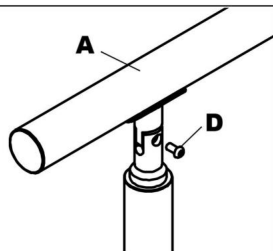

**STEG 3:** Installera ledstång.

**STEG 4:** Sätt ihop tvärbalken  
hopsättning.

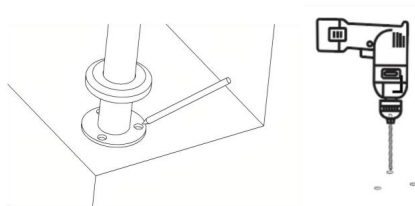
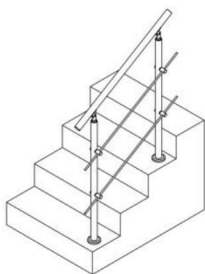

**STEG 5:** Sätt ledstangen på trappa.

**STEG 6:** Markera installationsplatsen och borra hål.

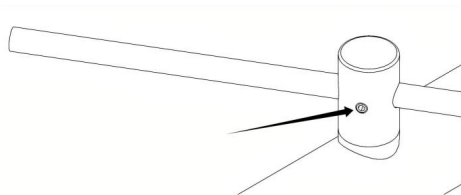
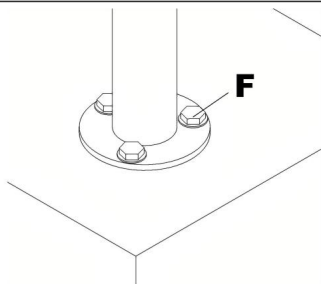

**STEG 7:** Montering av expansionsbult. **STEG 8:** Lås fast skruvarna.

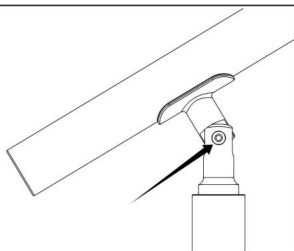

**STEG 9:** Låsskruvar.

**Tillverkare:** Shanghaimuxinmuyeyouxiangongsi

**Adress:** Shuangchenglu 803nong11hao1602A-1609shi, baoshanqu, shanghai  
200000 CN.

**Importerad till AUS:** SIHAO PTY LTD. 1 ROKEVA STREETEASTWOOD  
NSW 2122 Australien

**Importerad till USA:** Sanven Technology Ltd. Suite 250, 9166 Anaheim  
Place, Rancho Cucamonga, CA 91730



YH CONSULTING LIMITED.

C/O YH Consulting Limited Office 147,  
Centurion House, London Road,  
Staines-upon-Thames, Surrey, TW18 4AX



E-CrossStu GmbH

Mainzer Landstr.69,  
60329 Frankfurt am Main.

**VEVOR**®

**TOUGH TOOLS, HALF PRICE**

**Teknisk support och e-garanticertifikat**

**[www.vevor.com/support](http://www.vevor.com/support)**