

Owner's Manual and Installation Instructions

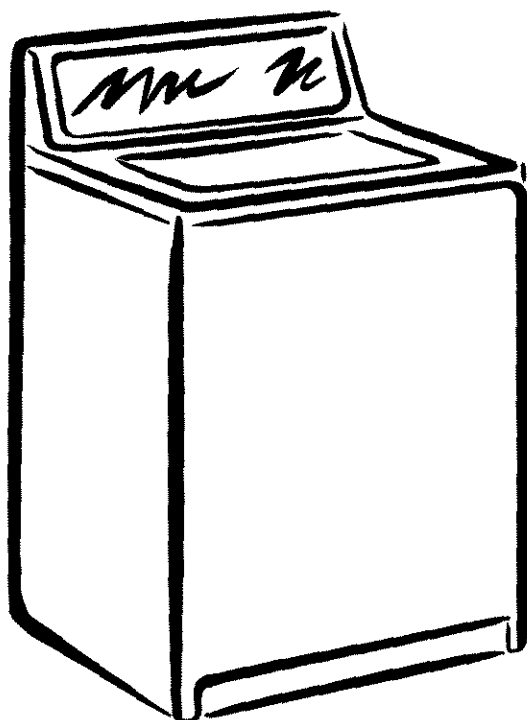

Three-Speed Timed Bleach AUTOMATIC WASHERS



ENGLISH

IMPORTANT:

Read and follow all safety
and operating instructions
before first use of this product.

Sears, Roebuck and Co., Hoffman Estates, IL 60179 U.S.A.
www.sears.com
Sears Canada Inc., Toronto, Ontario, Canada M5B 2B8
www.sears.ca

TABLE OF CONTENTS

BEFORE USING YOUR NEW WASHER	2
KENMORE ELITE™ WASHER WARRANTY	3
WASHER SAFETY	4
INSTALLATION INSTRUCTIONS	6
OPERATING YOUR WASHER	21
LAUNDRY TIPS	32
CARING FOR YOUR WASHER	34
TROUBLESHOOTING	35
SEARS MAINTENANCE AGREEMENT	39

BEFORE USING YOUR NEW WASHER

Please read this manual. It will help you install and operate your new Kenmore ELITE™ washer in the most economical way.

For more information about the care and operation of Kenmore ELITE™ appliances call your nearest Sears store. You will need the complete model and serial numbers when requesting information. Your washer's model and serial numbers are located on the Model and Serial Number Plate.

Use the space below to record the model number and serial number of your new Kenmore ELITE™ Washer.

Model No. _____

Serial No. _____

Date of Purchase _____

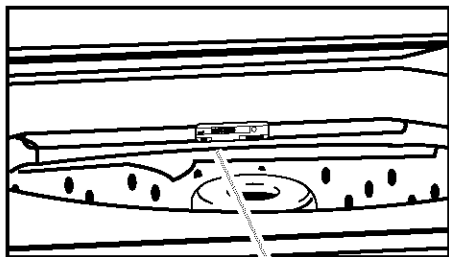

Model and Serial Number Plate

Keep this book and your Sears Salescheck (receipt) in a safe place for future reference.

KENMORE ELITE™ WASHER WARRANTY

Limited Lifetime Warranty on White Porcelain Basket

For the lifetime of the washer from the date of purchase, Sears will replace the white porcelain wash basket if it chips or rusts due to defective material or workmanship. After the first year, you will be charged for labor.

Limited 10-Year Warranty on Plastic Tub*

For the second through tenth year from the date of purchase, Sears will replace the plastic tub if it is defective in material or workmanship. After the first year, you will be charged for labor.

Limited 5-Year Warranty on Gearcase Parts*

For the second through fifth year from the date of purchase, Sears will replace any gearcase parts that are defective in material or workmanship. After the first year, you will be charged for labor.

Full 1-Year Warranty on Mechanical and Electrical parts

For one year from the date of purchase, if this washer is installed and operated according to the instructions that come with it, Sears will repair or replace any of its mechanical or electrical parts if they are defective in material or workmanship.

Warranty Restriction

If this washer is operated for any purpose other than private family use, all warranty coverage is restricted to 90 days from the date of purchase.

Warranty Service

Warranty service is available by contacting your nearest Sears Service Center in the United States or Canada.

This warranty applies only while this washer is used in the United States or Canada.

This warranty gives you specific legal rights and you may also have other rights that vary from state to state or province to province.

**Sears, Roebuck and Co.,
Dept 817WA,
Hoffman Estates, IL 60179**

**Sears Canada Inc., Toronto,
Ontario, Canada
M5B 2B8**

*In Canada a different warranty may apply.
In the U.S. for Sears warranty information or to contact a Sears Service Center, call 1-800-4-MY-HOMESM (1-800-469-4663).
In Canada, call 1-877-533-6937.

ENGLISH

WASHER SAFETY

Your safety and the safety of others is very important.

We have provided many important safety messages in this manual and on your appliance. Always read and obey all safety messages.



This is the safety alert symbol. This symbol alerts you to hazards that can kill or hurt you and others. All safety messages will be preceded by the safety alert symbol and the word "DANGER" or "WARNING". These words mean:

⚠ DANGER

You will be killed or seriously injured if you don't follow instructions.

⚠ WARNING

You can be killed or seriously injured if you don't follow instructions.

All safety messages will identify the hazard, tell you how to reduce the chance of injury, and tell you what can happen if the instructions are not followed.

IMPORTANT SAFETY INSTRUCTIONS

WARNING: To reduce the risk of fire, electric shock, or injury to persons when using your washer, follow basic precautions, including the following:

- Read all instructions before using the washer.
- Do not wash articles that have been previously cleaned in, washed in, soaked in, or spotted with gasoline, dry-cleaning solvents, other flammable or explosive substances as they give off vapors that could ignite or explode.
- Do not add gasoline, dry-cleaning solvents, or other flammable or explosive substances to the wash water. These substances give off vapors that could ignite or explode.
- Under certain conditions, hydrogen gas may be produced in a hot water system that has not been used for 2 weeks or more. **HYDROGEN GAS IS EXPLOSIVE.** If the hot water system has not been used for such a period, before using a washing machine, turn on all hot water faucets and let the water flow from each for several minutes. This will release any accumulated hydrogen gas. As the gas is flammable, do not smoke or use an open flame during this time.
- Do not allow children to play on or in the washer. Close supervision of children is necessary when the washer is used near children.
- Before the washer is removed from service or discarded, remove the lid.
- Do not reach into the washer if the tub or agitator is moving.
- Do not install or store this washer where it will be exposed to the weather.
- Do not tamper with controls.
- Do not repair or replace any part of the washer or attempt any servicing unless specifically recommended in the Owner's Manual or in published user-repair instructions that you understand and have the skills to carry out.
- See the "INSTALLATION INSTRUCTIONS" section for grounding requirements.

SAVE THESE INSTRUCTIONS

ENGLISH

INSTALLATION INSTRUCTIONS

INSTALLATION OVERVIEW

For a complete list of tools and parts needed, see pages 7-9.

A. SELECT LOCATION FOR YOUR WASHER (pgs. 11-13)

Recessed Area/
Closet Installation Instructions (p. 11)

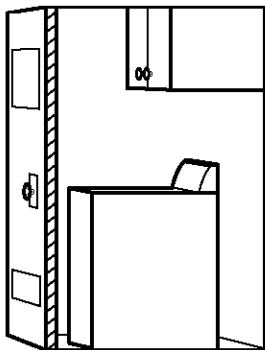

Standpipe Drain System (p. 13)

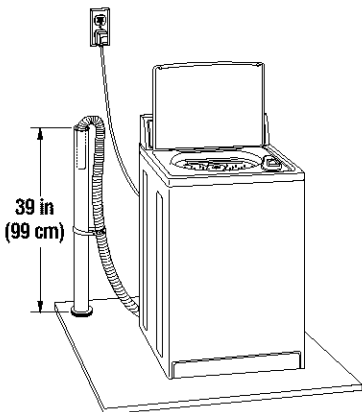

Laundry Tub Drain System (p. 12)

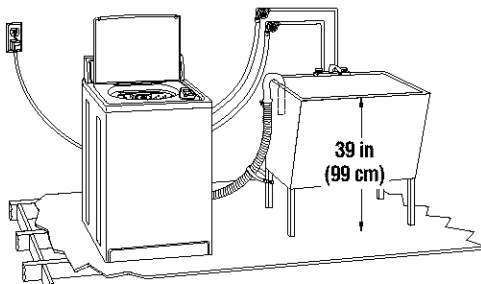

Floor Drain System (p. 13)

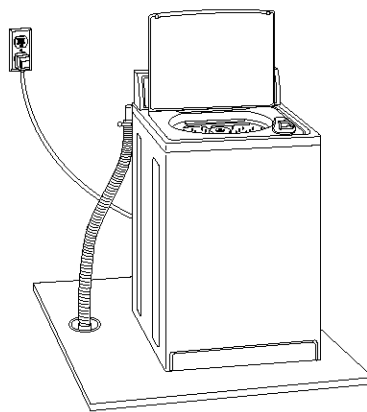

B. REMOVE SHIPPING STRAP (p. 14)

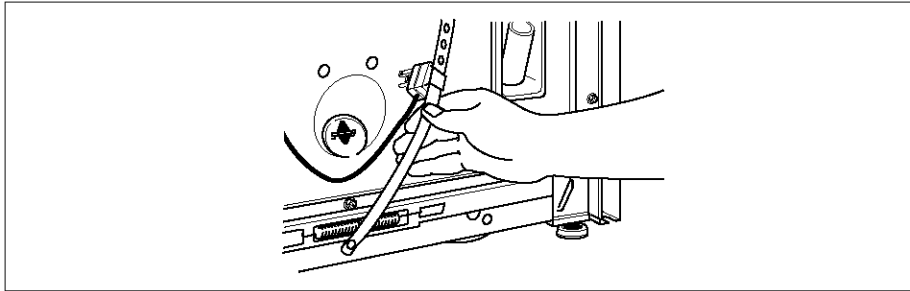

Tools Needed:

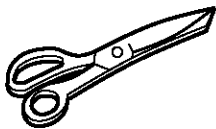

Scissors

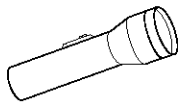

Flashlight
(optional depending on installation)

ENGLISH

C. CONNECT DRAIN HOSE (pgs. 15-16)

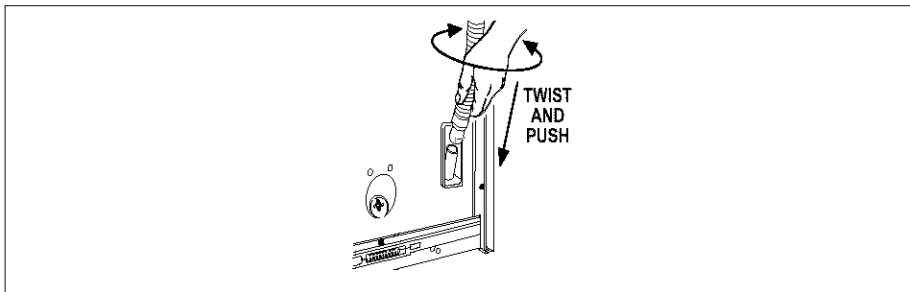

Tools Needed:

Parts Supplied:

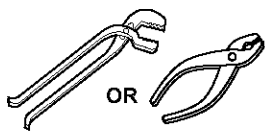

OR
Pliers that open
to 1 $\frac{1}{8}$ in (3.95 cm)

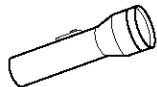

Flashlight (optional
depending on installation)

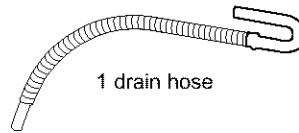

1 drain hose



1 yellow, single-wire
hose clamp (top of
drain hose)

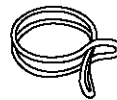

1 silver, double-wire
hose clamp (bottom of
drain hose)

D. CONNECT INLET HOSES TO WASHER (pgs. 16-17)

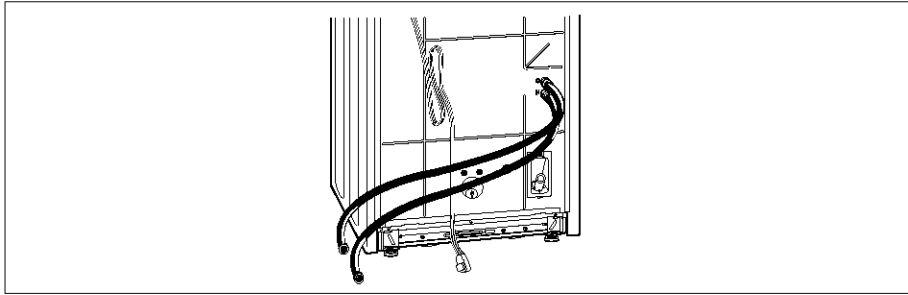

Tools Needed:

Parts Supplied:

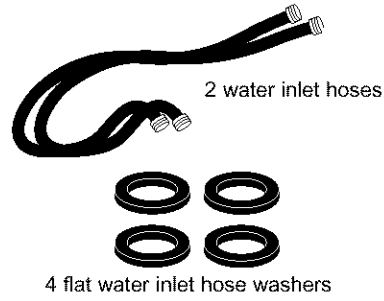
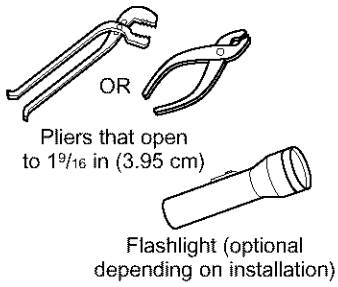

E. CONNECT INLET HOSES TO WATER FAUCETS (p. 17)

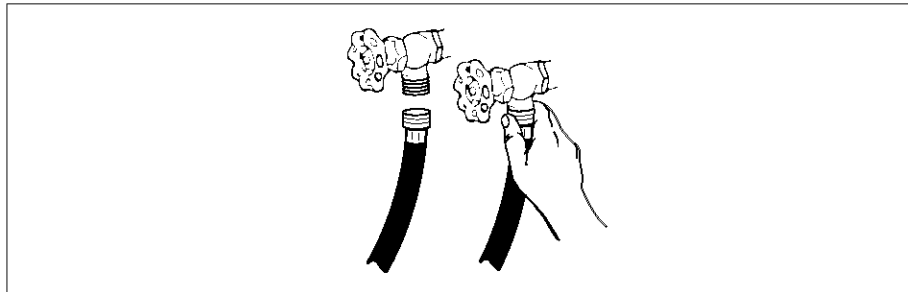

Tools Needed:

Parts Supplied:

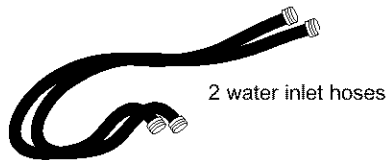
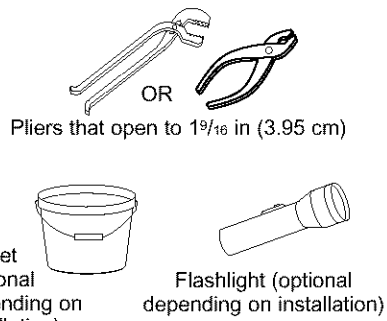

F. SECURE DRAIN HOSE (P. 18)

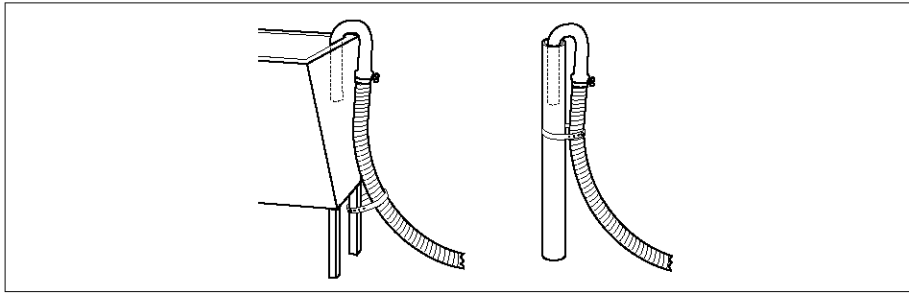

Tools Needed:

Parts Supplied:

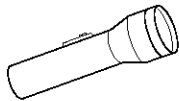

Flashlight (optional depending on installation)

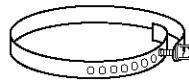

Shipping strap with fastener

ENGLISH

G. LEVEL WASHER (p. 19)

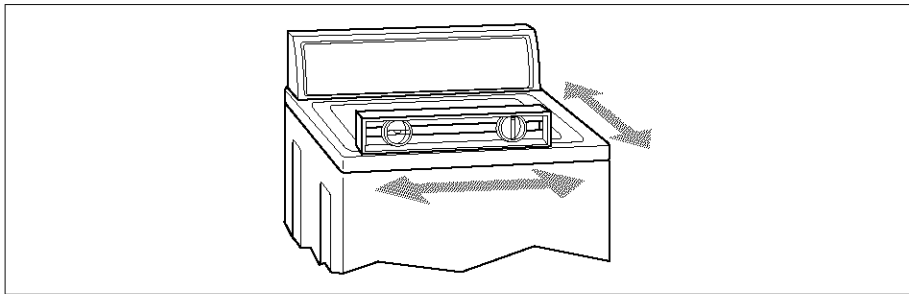

Tools Needed:

Parts Supplied:

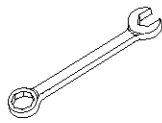

9/16-in (1.43 cm) open-end wrench

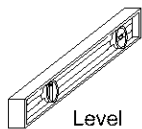

Level

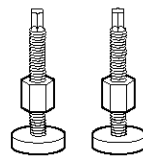

2 front leveling legs with nuts

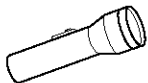

Flashlight (optional depending on installation)



Wood block

ELECTRICAL REQUIREMENTS

120-Volt, 60-Hz., AC-only, 15- or 20-ampere fused electrical supply is required. (Time-delay fuse or circuit breaker is recommended.) Connect to an individual branch circuit.

⚠ WARNING



Electrical Shock Hazard

Plug into a grounded 3 prong outlet.
Do not remove ground prong.
Do not use an adapter.
Do not use an extension cord.
Failure to follow these instructions can result in death, fire, or electrical shock.

This washer is equipped with a power supply cord having a 3-prong grounding plug. To minimize possible shock hazard, you must plug the power supply cord into a mating 3-prong grounding-type wall receptacle, grounded in accordance with National Electrical Code, ANSI/NFPA 70-latest edition and all local codes and ordinances.

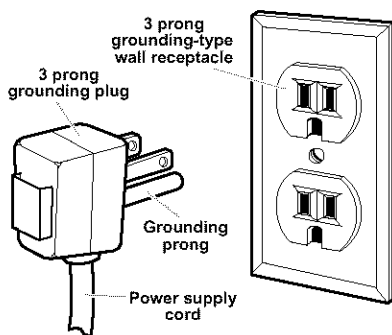

- **For a grounded, cord-connected washer:**

GROUNDING INSTRUCTIONS

This washer must be grounded. In the event of malfunction or breakdown, grounding will reduce the risk of electrical shock by providing a path of least resistance for electric current. This washer is equipped with a cord having an equipment-grounding conductor and a grounding plug. The plug must be plugged into an appropriate outlet that is properly installed and grounded in accordance with all local codes and ordinances.

WARNING: Improper connection of the equipment grounding conductor can result in a risk of electric shock. Check with a qualified electrician or serviceman if you are in doubt as to whether the appliance is properly grounded.

Do not modify the plug provided with the appliance – if it will not fit the outlet, have a proper outlet installed by a qualified electrician.

- **For a permanently connected washer:**

GROUNDING INSTRUCTIONS

This washer must be connected to a grounded metal, permanent wiring system, or an equipment grounding conductor must be run with the circuit conductors and connected to the equipment-grounding terminal or lead on the appliance.

**A. SELECT LOCATION
FOR YOUR WASHER –**

for your Benefit

Selecting the proper location for your washer will improve its performance and minimize concerns like washer walk or noise.

**RECESSED AREA/
CLOSET INSTALLATION INSTRUCTIONS**

This washer may be installed in a recessed area or closet.

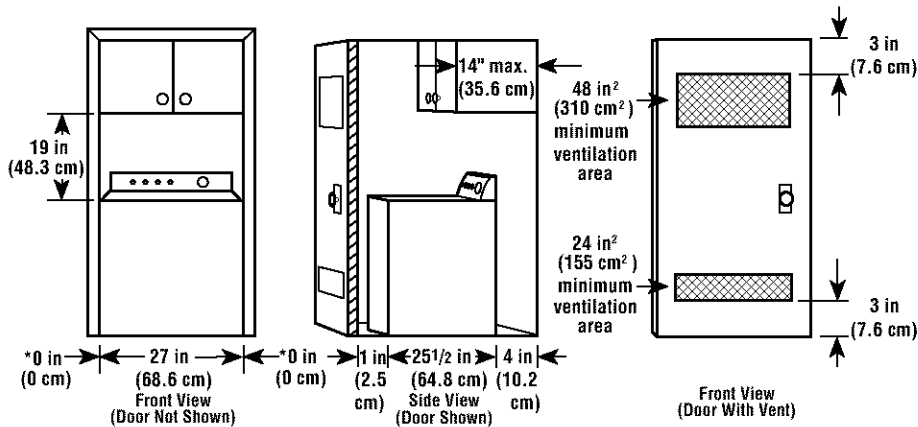

ENGLISH

*Additional clearance for wall, door and floor moldings may be required.
To reduce transfer of washer sounds, a clearance of 1 in (2.5 cm) on the sides of the washer is recommended.

- The installation spacing is in inches (centimeters) and is the minimum allowable.
- Allow additional space if other appliances are to be installed in the area.
- If closet door is installed, the minimum air openings in top and bottom are required. Louvered doors with equivalent air openings in top and bottom are acceptable.

LAUNDRY TUB DRAIN SYSTEM

Check location where washer will be installed. This washer can be installed using one of three systems:

- Laundry tub drain system (below)
- Standpipe drain system (p. 13)
- Floor drain system (p. 13)

Do not store or operate washer at or below 32°F (0°C) (some water may remain in washer). See page 34 for winterizing information.

Proper installation is your responsibility. Make sure you have everything necessary for correct installation including the following points:

Grounded receptacle: Must be within 4 ft (1.2 m) of where the power cord is attached to the back of the washer.

Hot and cold water faucets:

Must provide water pressure between 20-100 psi and be within 4 ft (1.2 m) of the hot and cold water fill valves attached to the back of the washer.

Laundry tub drain system:

Needs a minimum 20 gal (76 L) laundry tub.

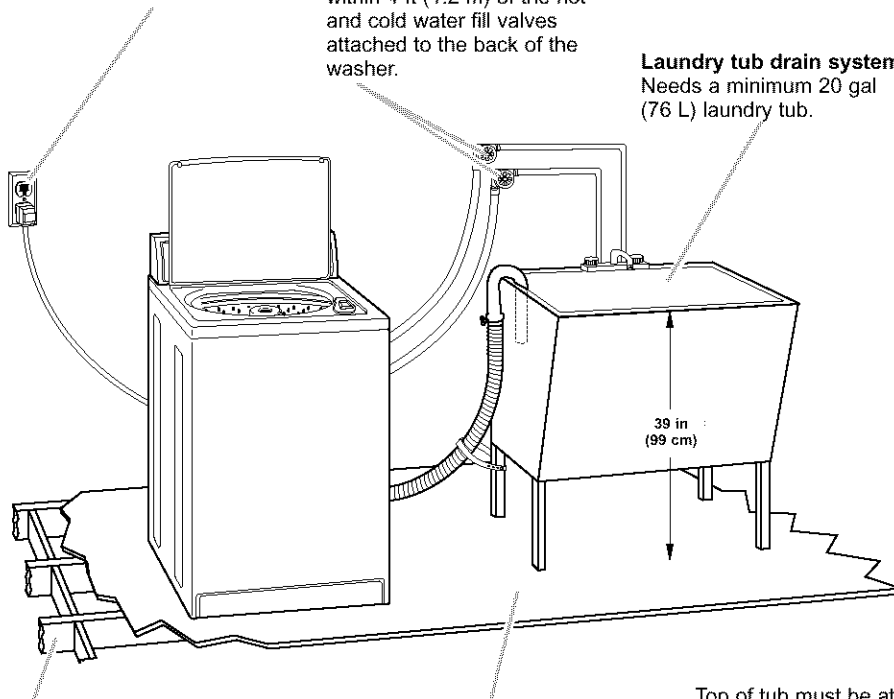

Support: Floor must be sturdy enough to support a total weight of 315 lbs (143 kg) (including washer, water, and load weight).

Level floor: Maximum allowable slope under entire washer – 1 in (2.5 cm).

Top of tub must be at least 39 in (99 cm) above floor and no higher than 96 in (2.4 m) from bottom of washer.

ALTERNATE LOCATIONS – STANDPIPE AND FLOOR DRAIN SYSTEMS

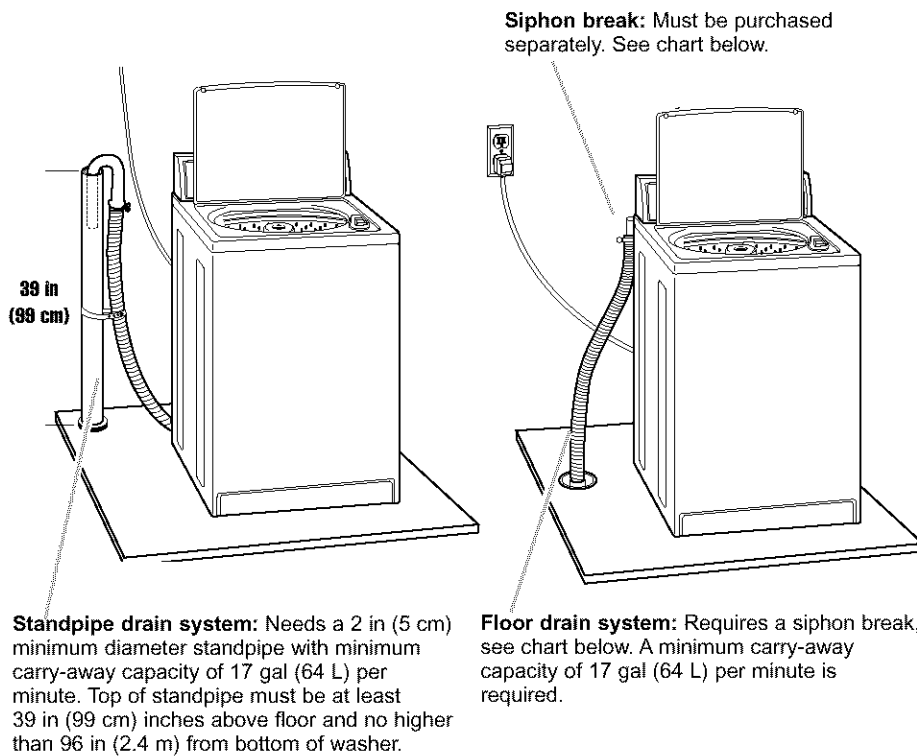

ENGLISH

If you have:	You will need to buy:
Laundry tub or standpipe taller than 96 in (2.4 m)	Sump pump system (if not already available)
1 in (2.5 cm) diameter standpipe	2 in (5 cm) diameter to 1 in (2.5 cm) diameter standpipe adapter, Part No. 3363920
Overhead sewer	Standard 20 gal (76 L), 39 in (99 cm) tall drain tub or utility sink and sump pump (available from local plumbing suppliers)
Floor drain	Siphon break, Part No. 285320; additional drain hose, Part No. 3357090; and Connector Kit, Part No. 285442

Parts listed are available from your local Sears store or Sears Service Center. In the United States, call 1-800-366-PART (1-800-366-7278). In Canada, call 1-877-533-6937.

B. REMOVE SHIPPING STRAP

for your **Benefit**

Removing the shipping strap is necessary for smooth operation. If the shipping strap is not removed, the washer will make excessive noise.

⚠ WARNING

Excessive Weight Hazard

Use two or more people to move and install washer.

Failure to do so can result in back or other injury.

To prevent floor damage, set washer onto cardboard before moving across floor. Move washer close to its final location.

STEP 1. Do not cut yellow strap. Pull yellow strap firmly, until completely removed from washer. Depending on your model, there should be either two or three cotter pins on the end of the shipping strap when it is pulled out of the washer. The electrical plug is attached to this shipping strap.

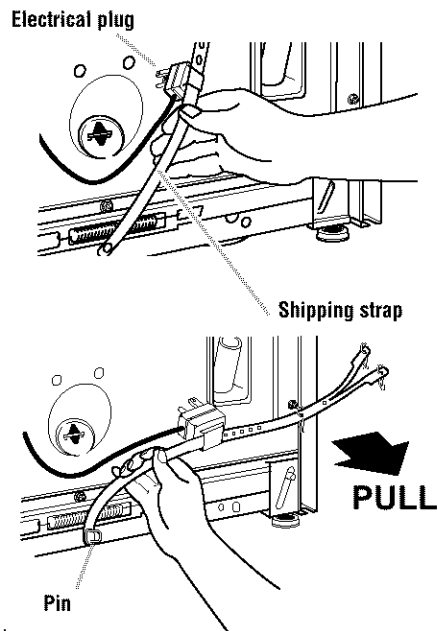

STEP 2. Pull firmly to remove the other end of the shipping strap pinned to the back of washer. This will release the rear self-leveling legs.

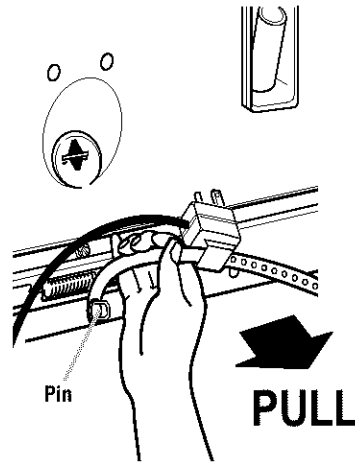

STEP 3. Cut the shipping strap about 16 inches (40 cm) from plug end. Look for the words "CUT HERE." Discard end with the cotter pins. **Slide remainder of shipping strap free from the electrical plug.** You will use this to secure the drain hose.

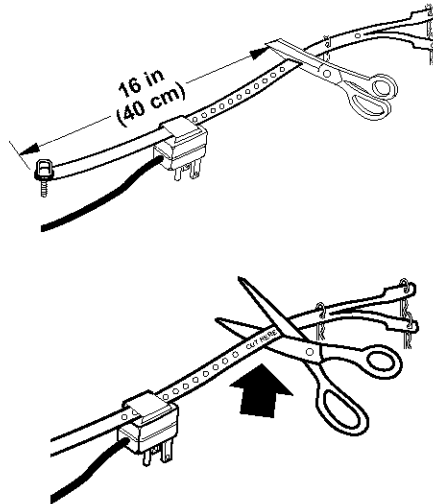

C. CONNECT DRAIN HOSE

for your Benefit

Proper connection of the drain hose will protect your floors from damage due to water leakage.

STEP 1. To prevent the drain hose from coming off or leaking, it must be installed per the following instructions:

IMPORTANT: To ensure proper installation, this procedure must be followed exactly.

- Wet the inside of the straight end of the drain hose with tap water. **DO NOT USE ANY OTHER LUBRICANT.**
- Squeeze ears of silver, double-wire clamp with pliers to open. Place clamp over the straight end of the drain hose $\frac{1}{4}$ inch from the end.

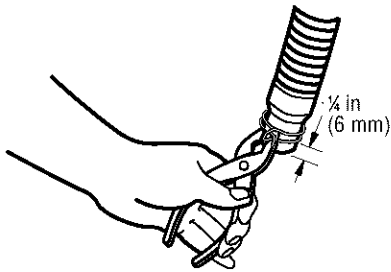

- Open clamp. Twist hose back and forth while pushing down onto drain connector at the bottom of the washer. Continue until hose contacts the ribbed stop on the cabinet.

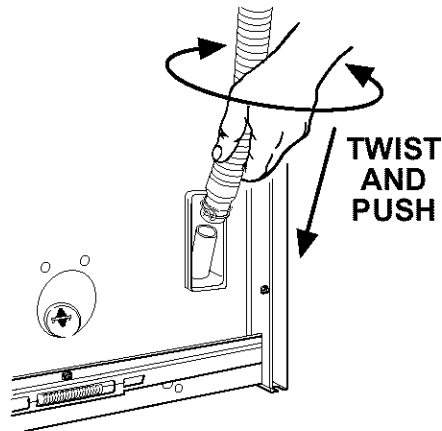

- Place clamp over area marked "CLAMP." Release clamp.

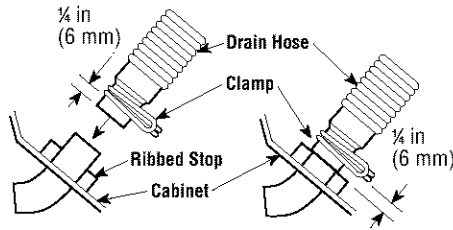

ENGLISH

If you have:	You will need to buy:
Drain hose that is too short	Drain hose, Part No. 388423 and hose kit, Part No. 285442
Drain hose that is too long	Hose kit, Part No. 285442
A problem with lint clogging your drain	Drain protector, Part No. 367031

Parts listed are available from your local Sears store or Sears Service Center. In the United States, call 1-800-366-PART (1-800-366-7278). In Canada, call 1-877-533-6937.

For standpipe or laundry tub drain systems:

STEP 2. Open yellow, single-wire clamp with pliers and slide over hooked end of drain hose to secure the rubber and corrugated sections together.

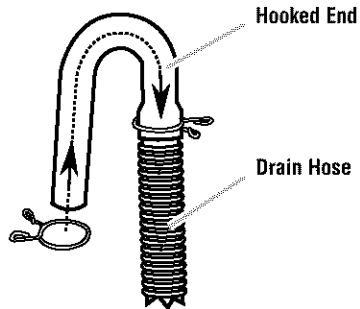

STEP 3. Put hooked end of drain hose into laundry tub or standpipe. Check for proper length of drain hose. Rotate hook to eliminate kinks.

To prevent drain water from going back into the washer:

- Do not straighten hooked end of drain hose and force excess drain hose into standpipe.
- Do not lay excess drain hose in bottom of laundry tub.

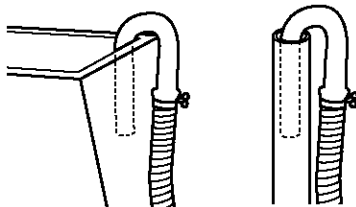

D. CONNECT INLET HOSES TO WASHER

for your **Benefit**

Proper connection of your inlet hoses will allow hot and cold water to enter your washer properly. We recommend connecting both the hot and cold water inlet hoses for optimal performance of your washer. If you only connect one water hose, you must cap off the remaining water inlet port.

NOTE: Replace inlet hoses after five years of use to reduce the risk of hose failure. Periodically inspect and replace inlet hoses if bulges, kinks, cuts, wear, or leaks are found. When replacing your inlet hoses, mark the date of replacement on the label with a permanent marker.

STEP 1. Insert one new, flat washer (from the parts bag) into each end of the inlet hoses. Check that washers are firmly seated in couplings.

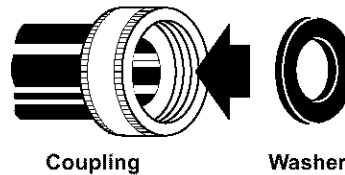

STEP 2. Attach the hose with the red coupling to the hot water (bottom) inlet valve. Attaching the red coupling first makes it easier to tighten connection with pliers. Screw on coupling by hand. Make an additional two-thirds turn with pliers to tighten coupling. **DO NOT OVERTIGHTEN;** this could damage the valves.

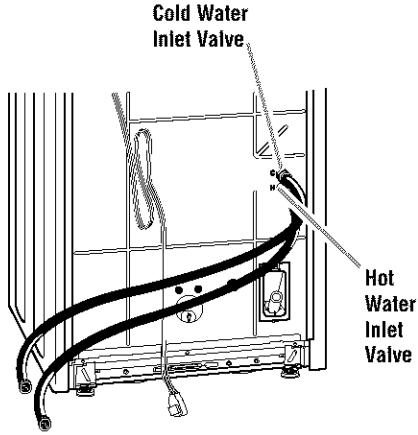

STEP 3. Attach the hose with the blue coupling to the cold water (top) inlet valve. Screw on coupling by hand. Make an additional two-thirds turn with pliers to tighten coupling. **DO NOT OVERTIGHTEN;** this could damage valves.

E. CONNECT INLET HOSES TO WATER FAUCETS

STEP 1. Make sure washer basket is empty. Run water through both faucets into a bucket or laundry tub to get rid of particles in the water lines that might clog hoses. Determine which faucet is hot and which is cold. Mark the hot water faucet.

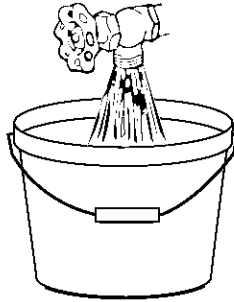

STEP 2. Attach the hose with the red coupling to the hot water faucet. Screw on coupling by hand. Make an additional two-thirds turn with pliers to tighten coupling. **DO NOT OVERTIGHTEN;** this could damage the coupling.

STEP 3. Attach the hose with the blue coupling to the cold water faucet. Screw on coupling to faucet by hand. Make an additional two-thirds turn with pliers to tighten coupling. **DO NOT OVERTIGHTEN;** this could damage the coupling.

STEP 4. Turn on water faucets and check for leaks. A small amount of water may enter the washer. You will drain this later.

If you have:

Water faucets beyond the reach of water fill hoses

You will need to buy:

2 longer water fill hoses:
6 ft (1.8 m) hoses, Part No. 76314
10 ft (3.0 m) hoses, Part No. 350008

Parts listed are available from your local Sears store or Sears Service Center. In the United States, call 1-800-366-PART (1-800-366-7278). In Canada, call 1-877-533-6937.

ENGLISH

F. SECURE DRAIN HOSE

for your **Benefit**

Securing the drain hose properly will protect your floors from damage due to water leakage.

STEP 1. Move washer to its final location.

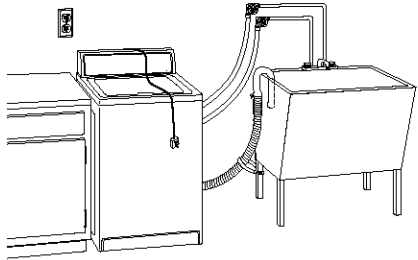

STEP 2. Locate the remaining piece of shipping strap (not the end with the cotter pins) from STEP 3 of "REMOVE SHIPPING STRAP." Use it to wrap the drain hose together with the laundry tub or standpipe. Push fastener into the nearest hole in the shipping strap.

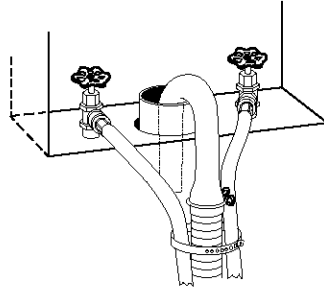
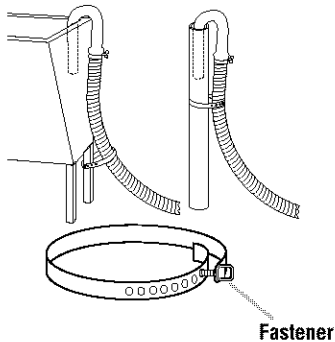

If the water faucets and drain standpipe are recessed, put hooked end of drain hose in standpipe. Tightly wrap the shipping strap around the drain hose and water inlet hoses (not the handles or stems). Push fastener into the nearest hole in the shipping strap.

G. LEVEL WASHER

for your **Benefit**

Leveling your washer properly prevents excessive noise and vibration.

To install front legs:

STEP 1. Prop front of washer up (about 4 in [10.2 cm]). Use a wood block or another object that will support the weight of the washer. If washer was placed against a wall, move the washer out slightly before tipping it up.

STEP 2. With one of the legs in hand, screw lock nut onto leg $\frac{3}{8}$ in (9.5 cm) from top of leg base. This is the recommended initial setting.

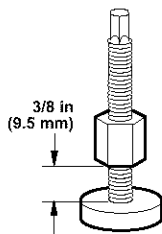

STEP 3. Screw leg into washer base by hand until nut reaches washer base. Repeat for other leg.

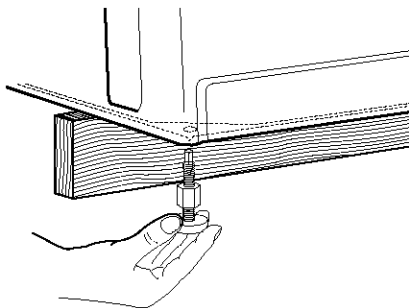

STEP 4. Tilt washer backward until front of washer is off the wood block. Remove wood block. Gently lower washer to floor.

STEP 5. Move washer to its final location.

STEP 6. Tilt washer forward until rear of washer is at least 3 in (7.6 cm) off floor. You may hear the self-adjusting rear legs click into place. Lower washer to floor. Check levelness of the washer by placing a level on top of the washer, first side-to-side; then front-to-back.

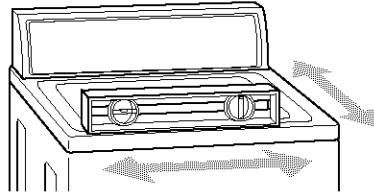

STEP 7. If washer is not level, prop up the front of the washer and adjust the legs up or down as necessary. Lower washer and reset self-adjusting rear legs (as in Step 6). Repeat Step 7 until the washer is level.

STEP 8. When washer is in its final location and level, use a $\frac{5}{16}$ in (1.43 cm) open-end wrench to turn nuts on front legs tightly against washer cabinet. If nuts are not tight against washer cabinet, the washer may vibrate.

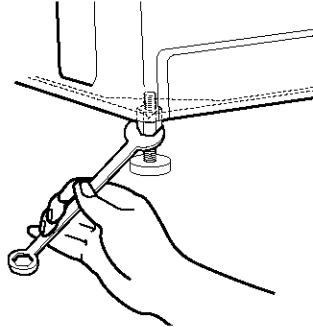

ENGLISH

REVIEW INSTALLATION

for your Benefit

Take a few minutes to complete this checklist. It will help assure you that you have a proper installation and increase your satisfaction with your Kenmore ELITE™ washer.

- Check electrical requirements. Be sure you have correct electrical supply and recommended grounding method.
 - Check that you have:
 - All the tools you started with.
 - Removed all shipping materials.
 - Removed shipping strap with cotter pins.
 - Installed all parts listed on pages 7-9.
 - Check that:
 - The washer is level.
 - The nuts on the front legs are tight.
 - Check that the water faucets are turned on.
-

FINAL STEPS

- Plug power supply cord into grounded outlet.
- Remove the blue protective film on the console and any tape remaining on washer.
- Take a few minutes and read the "OPERATING YOUR WASHER" section to fully understand your new washer. Then, start the washer and allow it to complete the ULTRA CLEAN Cycle.

OPERATING YOUR WASHER

for your **Benefit**

To get the maximum cleaning and fabric care from your washer, please read and follow these instructions.

NOTE: The drawings in this section show the basic features of all models covered by this manual. Refer to the supplied "Feature Sheet" for your washer's particular features.

LID INSTRUCTIONS



These instructions are found under the lid of your washer.

OPERATING SUGGESTIONS

DISPENSER ----- Add measured liquid chlorine bleach to the "Timed Bleach Dispenser". It will automatically dispense the bleach at the right time for the best wash performance. **DO NOT USE POWDERED BLEACH IN THIS DISPENSER.** Add measured fabric softener to the agitator mounted dispenser. Add measured detergent to the washer basket.

- 1. SELECT & ADJUST** Make the selections for these washer controls:
- **WATER LEVEL** ----- Adjust to load size.
 - **WASH / RINSE TEMP** ----- Adjust to the type of fabric and soil. Use **AUTO TEMP** selections for best wash performance.
 - **RINSE OPTIONS** ----- Select to add a second rinse automatically.
 - **SPEEDS** ----- Adjust to fabric type being washed.

GARMENT CARE SYMBOL	WASHER CYCLE	FABRIC / LOAD TYPE
	HEAVY DUTY	DENIMS, TOWELS; EXTRA DIRTY
	REGULAR	COTTONS
	PERM PRESS	SYNTHETICS
	DELICATE	KNITS
	HAND WASH	LINGERIE

GARMENT CARE SYMBOL	WATER TEMP SETTING	BLEACH RECOMMENDATION
•••	HOT WASH	
••	WARM WASH	
•	COLD WASH	
		ANY BLEACH
		NON-CHLORINE BLEACH
		DO NOT BLEACH

2. SELECT CYCLE ----- Choose more time for heavily soiled loads and less time for lightly soiled loads.

3. PULL TIMER TO START ----- Lid must be closed to complete cycle. ----- **PUSH TIMER TO STOP**

! WARNING



Fire Hazard

Never place items in the washer that are dampened with gasoline or other flammable fluids.

No washer can completely remove oil.











Do not dry anything that has ever had any type of oil on it (including cooking oils).

Doing so can result in death, explosion, or fire.

ENGLISH

STAIN REMOVAL GUIDE

It's best to wash stains as soon as possible.

 Blood	Rinse immediately or soak in cold water with detergent for 30 minutes. Rinse. Rub detergent into any remaining stains. Rinse thoroughly.
 Chocolate, Coffee	Sponge immediately or apply a prewash soil and stain remover. Rinse. Wash. If stain remains, apply a liquid detergent to stain or soak in warm water with detergent. Rewash.
 Cosmetics	Rub in a prewash stain remover. Wait 5 minutes. Wash with detergent and bleach in the hottest water safe for the fabric.
 Cream, Milk, Ice Cream	Sponge immediately or apply a prewash soil and stain remover. Rinse. Wash. Repeat if necessary. If stain remains, apply a few drops of liquid detergent. Rinse. If stain remains, soak. Wash.
 Dirty Mechanical Oil	Pretreat with liquid laundry detergent or a paste of granular laundry detergent. Wash in the hottest water safe for the fabric.
 Grape, Wine	Soak immediately in cool water. Wash. If stain remains, cover area with a paste made of color-safe bleach, a few drops of hot water and a few drops of ammonia. Wait 15 to 20 minutes. Wash.
 Grass	Use an enzyme presoak or rub enzyme detergent on the stain. Launder with detergent and bleach appropriate for the fabric.
 Ketchup, Tomato Products	Sponge immediately or apply a prewash soil and stain remover. Rinse. Wash. If stain remains, apply a liquid detergent to stain or soak in warm water with detergent. Rewash.
 Mud	Brush off the dry mud. Rinse under cold water. Pretreat with a paste of detergent and water. Launder using detergent and bleach safe for the fabric.
 Perspiration, Deodorants	Treat with a paste of ammonia and color-safe bleach. Let stand for 30 minutes. Wash in hottest water safe for fabric.
 Ring around the Collar	Pretreat with heavy duty liquid laundry detergent or soak garment in warm water with a granular laundry detergent.

- Do not tumble dry soiled or stained items. Heat may permanently set stains.
- For additional information regarding stains refer to owner's manual.

WATER LEVEL CONTROL

for your Benefit

This control gives you the flexibility to save water when washing small loads.

Your washer lets you select a water setting based on the size of your wash load.

- For normal loads, start with the MEDIUM LOAD Setting. Adjust up or down depending on your load. Clothes should move freely and roll toward the agitator.

Washers with a variable Water Level Control:

- The variable control lets you select a water level anywhere from SMALL LOAD to LARGE LOAD.
- To change to a higher water level setting after the washer has started to agitate, turn the knob to RESET, then to the desired new setting.

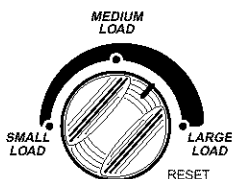

Washers with 4-position or 5-position Water Level Control:

- To change to a higher water level setting after the washer has started to agitate, turn the knob to the desired new setting.

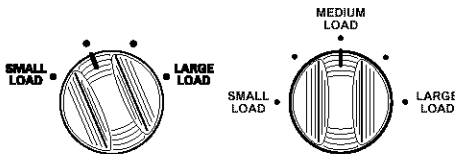

WATER TEMPERATURE CONTROL

Your washer lets you select a wash and rinse water temperature setting based on the type of load you are washing.

- Using warm rinse water will leave loads dryer after the spin cycle than if you use cold rinse water. However, warm rinses may increase wrinkling when line drying.
- In cold climates, warm rinse water also provides a more comfortable temperature for handling the wash load. Warm rinse is controlled to 75°F (24°C).

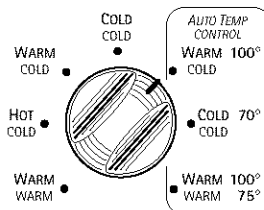

SELECTING WATER TEMPERATURES		
Wash Water Temperature	Suggested Fabrics	Comments
HOT 111°F (44°C) or above	<ul style="list-style-type: none"> • Work clothes • Sturdy whites/ colorfast pastels • Diapers 	<ul style="list-style-type: none"> • Best cleaning for heavily soiled items • Removes oils, perspiration, greasy soils and stains • Prevents graying or yellowing
WARM 90°-110°F (32°-43°C)	<ul style="list-style-type: none"> • Dark/non-colorfast colors • Permanent press items • Nylon, polyester, acrylics, silks, woolens • Knits/delicate fabrics 	<ul style="list-style-type: none"> • Best for moderately soiled to lightly soiled items • Safe for most fabric finishes • Less fading and dye bleeding • Reduces wrinkling
COLD* 70°-90°F (21°-32°C)	<ul style="list-style-type: none"> • Extra-sensitive colors • Non-colorfast items • Hand washables 	<ul style="list-style-type: none"> • Best for very lightly soiled items • Saves hot water

*In wash water temperatures colder than 70°F (21°C), detergents do not dissolve well. Also, soils may be difficult to remove and some fabrics may retain wear wrinkles and have increased pilling – the formation of small lint-like balls on the surface of garments. Pilling is the natural result of wearing and washing of garments.

AUTOMATIC TEMPERATURE CONTROL (ATC)

for your Benefit

ATC takes away the worry of undissolved detergent and ensures consistent cleaning results from season to season with warm and cold washes.

ATC electronically senses and maintains a uniform water temperature by regulating incoming hot and cold water.

- Even in cold wash, some warm water is let into the washer to maintain a temperature minimum of 70°F (21°C). In very cold water, detergent may not dissolve and clothes will not be cleaned completely.
- Warm wash is regulated at approximately 100°F (38°C). ATC does not control the hot wash water temperature.
- Warm rinse is regulated at approximately 75°F (24°C) for all warm rinse settings. This may be a cooler warm rinse than what you are used to, but it saves energy and still gives you proper rinsing and a load that is comfortable to remove.

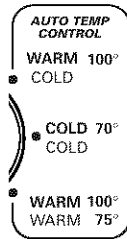

SPEEDS DESCRIPTIONS

This section illustrates and describes the wash/spin speeds you can select with the SPEEDS Control. Each speed setting is designed for different types of fabrics and soil levels.

HANDWASH PLUS FINE DELICATES

Use this speed setting for hand washable and special-care items. Garments are labeled “Hand Wash” because:

- The fiber or construction may be sensitive to agitation.
- The fabric contains sensitive dyes that may bleed.

The wash action mirrors the way you would treat hand washable garments in a sink. It does this by repeating periods of

extra-slow speed agitation and soaking. Slow spin speeds help reduce wrinkling. Do not use this cycle for large items like blankets.

NOTE: Some “Hand Wash” items, particularly wool, naturally shrink when washed. Keep this in mind when you purchase items labeled “Hand Wash.” Items that shrink should be dried flat. When still wet, block these items by gently stretching to original measurements.

HANDWASH/CASUAL

Use this speed setting for lingerie and loosely knit items. Setting combines extra-slow speed agitation for gentle soil removal and slow spin speeds to reduce wrinkling.

DELICATE

Use this speed setting for washable knit fabrics and permanent press fabrics. Setting combines slow speed agitation for gentle soil removal and slow spin speeds to reduce wrinkling.

REGULAR

Use this speed setting for normally soiled cottons and linens. Setting combines slow speed agitation and fast spin speeds to shorten drying time.

HEAVY DUTY

Use this speed setting for sturdy or heavily soiled loads. Setting combines fast speed agitation and fast spin speeds.

HANG DRY

Use this speed setting for sturdy permanent press fabrics that will be line dried. Setting combines fast speed agitation and slow spin speeds to reduce wrinkling.

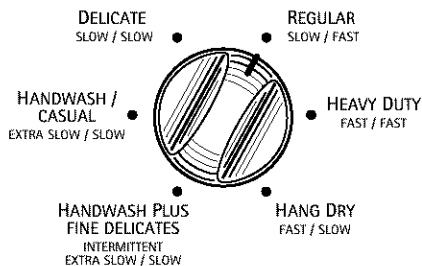

ENGLISH

SETTING YOUR CYCLE SELECTOR (TIMER) CONTROL

Use this control to choose the agitation time and to start the washer.

- For heavy soil and sturdy fabrics, use the full time.
- For light soil and delicate fabrics, use less time.

PERMANENT PRESS II

for your **Benefit**

The **PERMANENT PRESS II** Cycle includes a load cooling process that reduces wrinkling compared to other cycles.

You can select up to 10 minutes of wash time.

NOTE: When the timer reaches PAUSE, the washer will drain and pause for no more than two minutes while some of the wash water is drained and replaced with rinse water.

ULTRA CLEAN

Use this cycle for most loads to get between 6 and 16 minutes of wash time.

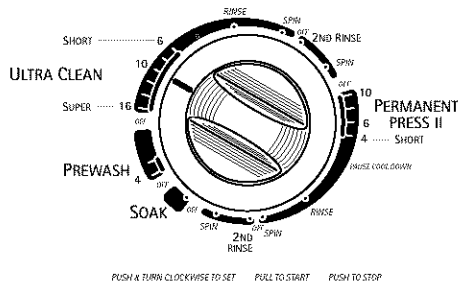

PREWASH

Use this cycle to get up to 4 minutes of agitation to help remove heavy soils and stains that need pretreatment. PREWASH Cycle should be followed by an ULTRA CLEAN or PERMANENT PRESS II Cycle with additional detergent added.

SOAK

SOAK Cycle features 4 minutes of agitation followed by an unlimited soak time to help remove heavy soils and stains that need pretreatment. You will need to reset the washer to a SPIN setting to remove water. SOAK Cycle should be followed by an ULTRA CLEAN, PERMANENT PRESS II, or PREWASH Cycle with additional detergent.

NOTE: We do not recommend hot water for soaking. It may set some stains.

UNDERSTANDING WHAT HAPPENS IN EACH CYCLE

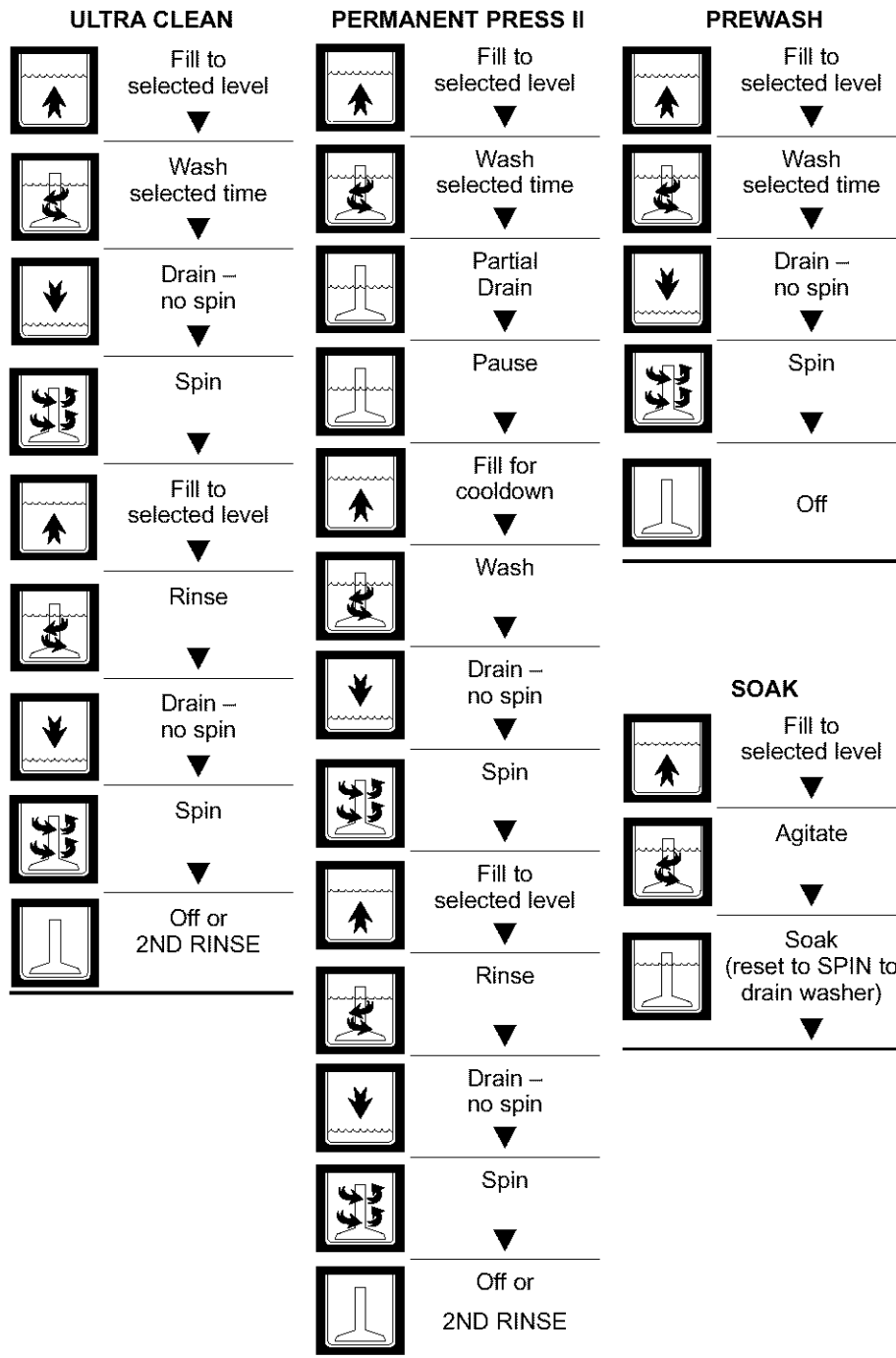

ENGLISH



RINSE OPTIONS CONTROL

for your **Benefit**

A second rinse will remove more detergent residue. It is especially beneficial if extra detergent has been used to remove heavy soils.

SECOND RINSE

Your washer allows you to add an automatic second rinse to the ULTRA CLEAN Cycle or PERMANENT PRESS II Cycle. Set the RINSE OPTIONS Control on 2ND RINSE before you start the washer. You won't have to come back to select a second rinse.

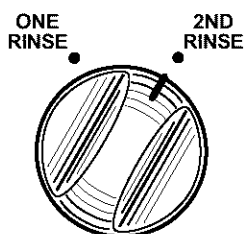

RINSE AND SPIN

When using extra detergent for heavily soiled clothes, or washing special-care items, you may find an extra rinse and spin is needed.

STEP 1. Set WATER LEVEL Control.

STEP 2. Set WATER TEMPERATURE Control.

STEP 3. Set RINSE OPTIONS Control to ONE RINSE.

STEP 4. Set SPEEDS Control:

STEP 5. Set the Cycle Selector Control (Timer) knob to a RINSE setting.

STEP 6. Pull Cycle Selector Control (Timer) knob out to start washer.

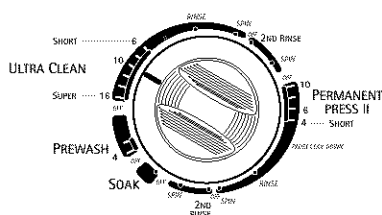

SPIN ONLY

A drain and spin may help shorten drying times for some heavy fabrics or special-care items by removing excess water.

STEP 1. Set RINSE OPTIONS Control to ONE RINSE.

STEP 2. Set SPEEDS Control:

- For fast spin, use the HEAVY DUTY setting.
- For slow spin, use the DELICATE setting.

STEP 3. Set the Cycle Selector Control (Timer) knob to a SPIN setting.

STEP 4. Pull the Cycle Selector Control (Timer) knob out to start washer.

SELF-CLEANING LINT FILTER

for your **Benefit**

Lint is filtered from the load automatically – there's no messy cleanup.

Your washer features a self-cleaning filter that traps lint from the water while the washer is washing and deep rinsing the laundry. The trapped lint is flushed down the drain automatically. You don't have to clean the filter.

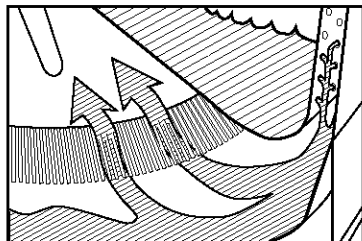

QUIET PAK™ II

The QUIET PAK™ II System is designed to reduce water sounds and ringing noises. The cabinet is insulated with three sound-dampening materials for superior vibration and sound-dampening characteristics.

TOTAL CARE™ AGITATOR

for your **Benefit**

Kenmore's exclusive TOTAL CARE™ Agitator has triple action agitation to give you the most flexible fabric care for even your largest loads.

The TOTAL CARE™ Agitator moves in three directions, depending on load size, to ensure proper cleaning. The best cleaning action in your washer takes place at the bottom where the agitator vanes move back and forth to flex the fabric, loosening the soil.

The upper portion of the agitator features special vanes that push the clothes down in a spiraling pattern to where the cleaning action is, displacing the clothes that are there with a "roll-over" motion.

For your largest loads, the TOTAL CARE™ Agitator offers a load-sensing feature that actually senses when you are washing a very large load and responds with a third, vertical motion that senses the load size and guides items to the bottom.

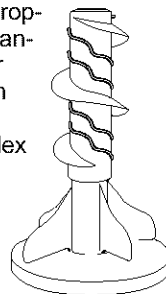

ENGLISH

UNDERSTANDING NORMAL WASHER SOUNDS

Your new washer may make sounds that your old one didn't. Because the sounds are unfamiliar, you may be concerned about them.

The following describes some of the normal sounds you may hear and what causes them.

During Washing

When you select a small load size setting for a small wash load, your washer has a lower water level. With this lower water level, you may hear a clicking sound from the upper portion of the agitator.

During Drain

The rate that water is drained from your washer depends on your installation. If water is drained quickly from the washer, you may hear air being pulled through the pump. This happens during the end of draining.

After Drain and Before Spin

When the cycle changes from draining to spinning, you may hear a noise as the gearcase shifts.

USING THE LIQUID CHLORINE BLEACH DISPENSER

for your **Benefit**

The liquid chlorine bleach dispenser automatically dispenses bleach at the proper time in the cycle to ensure the cleanest and brightest loads.

Always measure liquid chlorine bleach. Use a measuring cup, do not guess. Do not pour directly from bottle. Never use more than 1 cup (250 mL) for a full load. Use less with smaller loads. Follow manufacturer's directions for safe use. A cup with a pouring spout will help you avoid spilling.

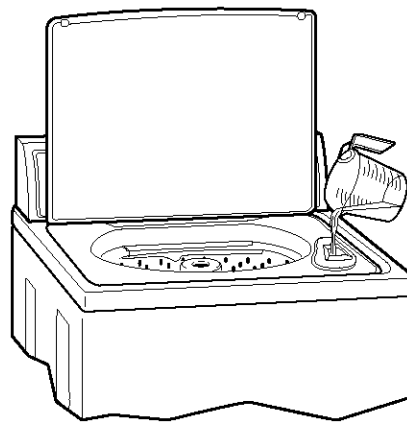

After loading the washer, pour measured liquid chlorine bleach carefully into the dispenser.

- Do not let bleach splash, drip, or run down into washer basket. Undiluted bleach will damage any fabric it touches.
- Start the washer. Bleach will be dispensed automatically after the detergent has had time to work.
- **Do not overfill.** Look for the level markings on the dispenser cover. Dispenser holds 1 cup (250 mL) of liquid chlorine bleach.

NOTE: Do not use this dispenser to add powdered chlorine or color-safe bleach to your washer load. The dispenser is for liquid chlorine bleach only.

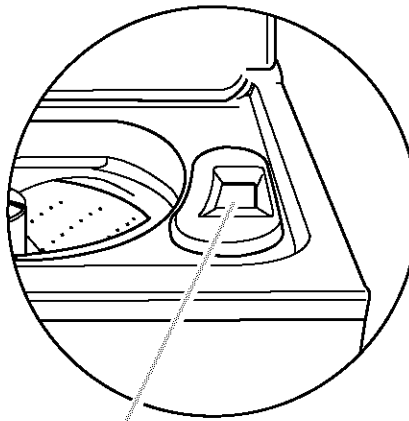

Liquid chlorine bleach dispenser

USING THE LIQUID FABRIC SOFTENER DISPENSER

After loading the washer, measure and add the recommended amount of fabric softener into the dispenser. Follow manufacturer's directions.

NOTE: Pouring too much fabric softener into the dispenser will cause the fabric softener to dispense instantly into the load due to siphoning action. This instant "dump" could damage fabrics and will make it appear that your dispenser is not working correctly.

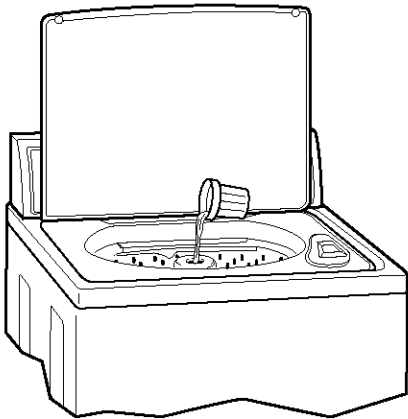

- Add warm water to fill the dispenser until it reaches the bottom of the opening of the funnel-shaped portion of the dispenser.
- Fabric softener is dispensed into the first deep rinse water automatically.

NOTE: Fabric softeners are not compatible with detergents. This dispenser should never be used in the PREWASH Cycle since it would dispense fabric softener into a wash load that has not been rinsed. Undiluted fabric softener spilled on fabric may result in spots that look like oil stains.

If you ever use your dispenser this way by mistake, rewash the load with extra detergent to remove these deposits.

To Remove the Fabric Softener Dispenser for Cleaning:

STEP 1. Pull up on the Fabric Softener Dispenser to remove the dispenser from the agitator.

STEP 2. Grasp both ends of the dispenser. Pull to separate.

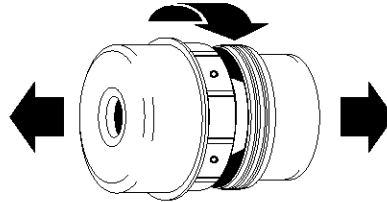

STEP 3. Remove internal holding cup.

STEP 4. Rinse all three parts with warm water.

STEP 5. Place the holding cup in the top outer portion of the dispenser.

STEP 6. Snap the bottom and the top of the Fabric Softener Dispenser together.

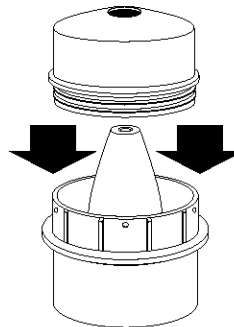

STEP 7. Replace the dispenser on the agitator; press firmly to snap into place.

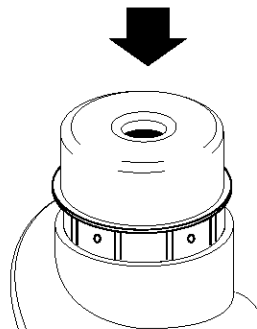

ENGLISH

LAUNDRY TIPS

PREPARING CLOTHES FOR WASHING

for your **Benefit**

Follow these recommendations to help you prolong the life of your garments.

- Close zippers, snaps, and hooks to avoid snagging other items. Remove pins, buckles, and other hard objects to avoid scratching the washer interior. Remove non-washable trim and ornaments.
- Empty pockets and turn them inside out.
- Turn down cuffs, brush away lint and dirt.
- Turn synthetic knits inside out to avoid pilling.
- Tie strings and sashes so they will not tangle.
- Mend tears, loose hems, and seams.
- Treat spots and stains.
- Stained or wet garments should be washed promptly for best results.

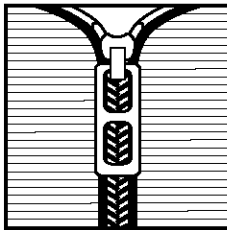

SORTING

- Separate heavily soiled items from lightly soiled ones, even if they would normally be washed together. Separate lint givers (towels, chenille) from lint takers (corduroy, synthetics, permanent press). When possible, turn lint givers inside out.
- Separate dark colors from light colors, colorfast items from non-colorfast items.
- Sort by fabric and construction (sturdy cottons, knits, delicate items).

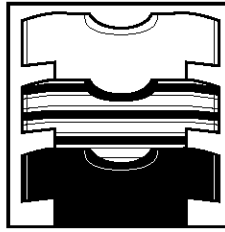

LOADING

for your Benefit

Proper loading of your washer contributes to proper cleaning and fabric care and reduces machine noise.

- Drop items into washer loosely. Fill to the top of the basket (top row of holes). Do not wrap items around the agitator. Items should move easily through wash water for best cleaning and wrinkle-free results. Items should sink and reappear later.
- Load washer properly and select correct water level setting. Overloading or packing the machine, and selecting a setting too small for the wash load can:
 - cause poor cleaning
 - increase wrinkling
 - create excessive lint
 - wear out items faster (because of pilling)
- Load by the amount of space items take up, not by their weight.
- Mix large and small items in each load. Load evenly to maintain washer balance. An off-balance load can make the washer vibrate during spin.
- Use a higher water level setting to reduce wrinkling with permanent press clothes and some synthetic knits. These items should have more room to move in the water than heavy items (towels, jeans).

- Reduce wash time by using a lower water level setting. Loads with only a few small items need less wash time.

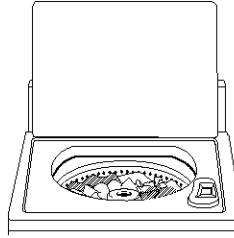

Loading Suggestions

For these suggested full-sized loads, set the WATER LEVEL selector to the highest water level setting.

KING SIZE™ CAPACITY WASHERS		
Heavy Work Clothes	Towels	Mixed Load
4 jeans	10 bath towels	3 sheets (1 king, 2 twin)
4 workpants	10 hand towels	4 pillowcases
4 workshirts	14 wash cloths	3 shirts
2 sweatshirts		3 blouses
2 sweatpants		9 T-shirts
		9 shorts
		10 handkerchiefs

ENGLISH

CARING FOR YOUR WASHER

CLEANING YOUR WASHER

Exterior

Wipe up detergent, bleach, and other spills with a soft, damp cloth or sponge as they occur. Occasionally wipe the outside of the washer to keep it looking like new.

Do not put sharp or metal objects in your washer. They can damage the finish. Check all pockets for pins, clips, money, bolts, nuts, etc. Do not lay these objects on your washer after emptying pockets.

Interior

Clean interior with 1 cup (250 mL) of chlorine bleach mixed with 2 cups (500 mL) of detergent. Run washer through a complete cycle using hot water. Repeat process if necessary.

NOTE: Remove hard water deposits using only cleaners labeled as washer safe.

WATER INLET HOSES

Replace inlet hoses after five years of use to reduce the risk of hose failure. Periodically inspect and replace inlet hoses if bulges, kinks, cuts, wear or leaks are found. When replacing your inlet hoses, mark the date of replacement on the label with a permanent marker.

WINTER STORAGE OR MOVING CARE

Install and store your washer where it will not freeze. Because some water may stay in the hoses and pump, freezing can damage your washer. If storing or moving your washer during freezing weather, winterize it.

To winterize washer:

1. Shut off both water faucets.
2. Disconnect and drain water inlet hoses.
3. Put 1 qt (1 L) of R.V.-type antifreeze in the basket.
4. Run washer on a SPIN setting for about 30 seconds to mix the antifreeze and water. Some of the mixture will pump out while the washer spins.
5. Unplug the power supply cord.

To use washer again:

1. Flush water pipes and hoses.
2. Reconnect water inlet hoses.
3. Turn on both water faucets.
4. Reconnect power supply cord.
5. Run the washer through a complete cycle with 1 cup (250 mL) of detergent to clean out antifreeze.

NON-USE OR VACATION CARE

Operate your washer only when you are at home. If you will be on vacation or not using your washer for an extended period of time, you should:

- Unplug the power supply cord or turn off electrical power to the washer.
- Turn off the water supply to the washer. This helps avoid accidental flooding (due to a water pressure surge) while you are away.

TROUBLESHOOTING

Most laundering problems are easily solved if you understand the cause. Check these lists for common laundry and washer problems. If you need further assistance, see service and assistance information on the back cover.

Problem	Possible Cause	Solution
Washer Leaks	Household plumbing is leaking.	Repair plumbing.
	Inlet hoses not tight.	Tighten hoses (see "Installation Instructions," Section D & E).
	Inlet hose washers not properly seated.	Reseat washers (see "Installation Instructions," Section D).
	Drain hose not properly clamped or is off.	Clamp drain hose (see "Installation Instructions," Section C).
	Drain is clogged.	Remove drain clogs. Sink, standpipe, or floor drain must be able to handle 17 gal (64 L) of water per minute.
	Tub moved forward during unloading, causing water to deflect off tub ring.	Ensure tub is centered before starting washer.
	Unit not level causing water to deflect off tub ring.	Ensure front feet are installed and nuts are tightened. Level washer. Reset rear legs (see "Installation Instructions," Section G).
	Load is unbalanced. Spray rinses are deflecting off load.	Redistribute the load.
Won't Drain/ Won't Spin/ Wet Loads	Washer is overloaded. Fills or spray rinses are deflecting off load.	Reduce load size.
	Drain hose is kinked or clogged.	Straighten or unplug hose (see "Installation Instructions," Section C).
	Correct operation of neutral drain.	After a wash or rinse, the washer will drain without spinning. After draining, the spinning begins.
	Lid is open.	Close the lid.
	Drain hose is more than 96 in (2.4 m) above floor.	Lower drain hose (see "Installation Instructions," Section A).
	Too much detergent – excessive sudsing.	Use less detergent.
Wrong cycle for load being washed.	Choose a cycle with a higher spin speed (see "Operating Your Washer").	

ENGLISH

Problem	Possible Cause	Solution
Won't Drain/ Won't Spin/ Wet Loads (cont.)	Low voltage or using an extension cord.	Check electrical source or call electrician. Do not use extension cords.
	Cold rinses.	Cold rinses leave loads wetter than warm rinses. This is normal.
Continues to Fill/ Continues to Drain/Cycle Stuck	Drain hose is less than 39 in (99 cm) above floor.	Raise the drain hose (see "Installation Instructions," Section A).
	Drain hose fits tightly into standpipe.	Adjust drain hose for loose fit (see "Installation Instructions," Section C).
	Drain hose taped into standpipe.	Do not seal off drain hose with tape. The drain hose needs an air gap.
Washer Makes Noise	Load is unbalanced.	Redistribute load.
	Washer is not level. Rear leveling legs not set.	Level washer. Reset rear legs (see "Installation Instructions," Section G).
	Nuts on front feet not tight.	Tighten nuts (see "Installation Instructions," Section G).
	Yellow shipping strap with cotter pins not completely removed.	Remove strap with cotter pins (see "Installation Instructions," Section B).
	Floor not strong enough to support washer.	Relocate washer (see "Installation Instructions," Section A).
	Gears engaging after drain and before spin.	This is normal.
	Upper part of agitator clicks during wash.	This is normal.
Won't Fill/Won't Rinse/Won't Agitate/ Wrong Temperature	Water inlet valve screens are plugged.	Clean screens.
	Water is turned off.	Turn on water.
	Hot and cold hoses are reversed.	Reverse hoses (see "Installation Instructions," Section D & E).
	Inlet hose is kinked.	Straighten hoses.
	Timer dial is not lined up.	Turn timer knob to the right slightly and pull to start.
	Power cord not plugged in.	Plug in power cord.

Problem	Possible Cause	Solution
Machine Stops	Power cord not plugged in.	Plug in power cord.
	No power at plug.	Check electrical source or call electrician.
	Fuse blown or circuit breaker open.	Replace fuse or reset circuit breaker. If problem continues, call electrician.
	Using an extension cord.	Do not use extension cords.
	Timer is not lined up.	Turn timer to the right slightly and pull to start.
	Timer knob not pulled out.	Set and pull out knob.
	Washer at pause in PERMANENT PRESS II Cycle (approximately two minutes). Machine is overloaded.	Allow cycle to continue (see "Operating Your Washer"). Wash smaller loads.
Agitator Not Working	The top of the agitator moves only in one direction.	This is normal.
	The top of the agitator is loose.	This is normal.
Water Level Too Low/Not Completely Filling	The top of the agitator is much higher than the highest water level. This creates a perception of the washer not being full.	This is normal.
Tub is Crooked	Tub pulled forward when unloading.	Ensure tub is centered before starting washer.
	Tub moves.	This is normal.
	Unit not level.	Ensure front feet are installed and nuts are tightened. Level washer. Reset rear legs (see "Installation Instructions," Section G).
Lint on Load	Improper sorting.	Sort lint givers from lint takers and by color.
	Overloading.	Lint can be trapped in load if overloaded. Wash smaller loads.
	Paper or tissue in pockets.	Clean out pockets before washing.
	Not enough detergent.	Use enough detergent to hold lint in water.
	Detergent not dissolving. Water temperatures lower than 70°F (21°C).	Use Automatic Temperature Control (ATC). ATC ensures wash water temperature will be warmer than 70°F (21°C).

Problem	Possible Cause	Solution
Tearing	Overloading. Improper use of washer.	Loads should move freely during wash. Wash smaller loads or increase water level.
	Improper use of chlorine bleach. Undiluted bleach will damage fabrics.	Do not pour chlorine bleach directly on load. Wipe up bleach spills.
	Sharp items not removed from pockets; fasteners not fastened.	Clean out pockets before washing. Zip zippers before washing.
	Items damaged before washing.	Mend rips and broken threads in seams before washing.
Stains on Load	Improper use of fabric softener in washer or dryer.	Dilute fabric softener and add to deep rinse only.
	Iron in water (rust).	Install an iron filter.
	Under use of detergent causing soil to be redeposited.	Use enough detergent to remove soil and hold it in suspension.
	Dye transfer due to not sorting loads properly.	Sort dark clothing from whites and lights.
	Dye transfer due to not unloading washer promptly.	Unload the washer as soon as it stops.
Load is Wrinkled	Not removing load promptly.	Unload the washer as soon as it stops.
	Wrong cycle for fabrics being washed.	Use cold rinses and cycles with slow spin speeds to reduce wrinkling.
	Overloading.	Loads should move freely during wash. Wash smaller loads.
	Wash water not warm enough to relax wrinkles. Using warm rinses.	Use Automatic Temperature Control (ATC). If safe for fabric, use warm or hot wash water. Use cold rinse water.
	Hoses reversed.	Reverse hoses (see "Installation Instructions," Section E).
Load is Tangled/ Twisted	Overloading.	Loads should move freely during wash. Wash smaller loads.
	Clothes wrapped around agitator.	Do not wrap items around agitator when loading washer.
Clogged Dispensers/ Bleach Leaking/ Bleach on Wrong Loads	Not diluting softener.	Dilute fabric softener in dispenser.
	Use of color-safe bleach in chlorine bleach dispenser.	Add color-safe bleach directly to the basket. Do not use chlorine bleach dispenser.
	Improper use of chlorine bleach.	Always measure bleach before adding to the dispenser. Carefully pour into the dispenser. Wipe up bleach spills.

SEARS MAINTENANCE AGREEMENT

KENMORE ELITE™ WASHERS

"We Service What We Sell" is our assurance you can depend on Sears for service. Your Kenmore appliance has added value when you consider that Sears has service units nationwide, staffed with professional technicians trained on all appliances Sears sells. They have the knowledge and skills, tools, parts and equipment to ensure our pledge to you that "We Service What We Sell."

Maintain the value of your purchase with a Sears Maintenance Agreement. Kenmore appliances are designed, manufactured and tested for years of dependable operation. Yet any major appliance may require service from time to time. The Sears Maintenance Agreement offers you an outstanding service program for your product.

The Sears Maintenance Agreement

- Is your way to buy tomorrow's service at today's prices.
- Eliminates repair bills resulting from normal use.
- Allows for as many service calls as required.
- Provides an annual Preventive Maintenance Check at your request to keep your Kenmore appliance in proper running condition.

**For more information, call
1-800-827-6655 (USA) or
1-877-533-6937 (Canada)**

ENGLISH

NOTES

For in-home major brand repair service:

Call 24 hours a day, 7 days a week

1-800-4-MY-HOMESM (1-800-469-4663)

Para pedir servicio de reparación – 1-800-676-5811

Au Canada pour tout le service – 1-877-LE-FOYERSM (1-877-533-6937)

For the repair or replacement parts you need:

Call 6 a.m. – 11 p.m. CST, 7 days a week

PartsDirectSM

1-800-366-PART (1-800-366-7278)

www.sears.com/partsdirect

Para ordenar piezas – 1-800-659-7084

For a Sears Service Center location in your area:

Call 24 hours a day, 7 days a week

1-800-488-1222

For a Sears Maintenance Agreement purchase or inquiry:

Call 7 a.m. – 5 p.m. CST, Monday – Saturday

1-800-827-6655

