

SAMSUNG

FULL MANUAL

HW-S800B / HW-S801B

Imagine the possibilities

Thank you for purchasing this Samsung product.

To receive more complete service, please register your product at
www.samsung.com/register









SAFETY INFORMATION

SAFETY WARNINGS

TO REDUCE THE RISK OF ELECTRIC SHOCK, DO NOT REMOVE THE COVER (OR BACK).

NO USER-SERVICEABLE PARTS ARE INSIDE. REFER SERVICING TO QUALIFIED SERVICE PERSONNEL.

Refer to the table below for an explanation of symbols which may be on your Samsung product.

	CAUTION RISK OF ELECTRIC SHOCK. DO NOT OPEN.	
	This symbol indicates that high voltage is present inside. It is dangerous to make any kind of contact with any internal part of this product.	
	This symbol indicates that this product has included important literature concerning operation and maintenance.	
	Class II product : This symbol indicates that a safety connection to electrical earth (ground) is not required. If this symbol is not present on a product with a power cord, the product MUST have a reliable connection to protective earth (ground).	
	AC voltage : Rated voltage marked with this symbol is AC voltage.	
	DC voltage : Rated voltage marked with this symbol is DC voltage.	
	Caution. Consult Instructions for use : This symbol instructs the user to consult the user manual for further safety related information.	

WARNING

- To reduce the risk of fire or electric shock, do not expose this appliance to rain or moisture.

CAUTION

- TO PREVENT ELECTRIC SHOCK, MATCH WIDE BLADE OF PLUG TO WIDE SLOT, FULLY INSERT.
- This apparatus shall always be connected to a AC outlet with a protective grounding connection.
- To disconnect the apparatus from the mains, the plug must be pulled out from the mains socket, therefore the mains plug shall be readily operable.
- Do not expose this apparatus to dripping or splashing. Do not put objects filled with liquids, such as vases, on the apparatus.
- To turn this apparatus off completely, you must pull the power plug out of the wall socket. Consequently, the power plug must be easily and readily accessible at all times.

WIRING THE MAIN POWER SUPPLY PLUG (UK ONLY)

IMPORTANT NOTICE

The mains lead on this equipment is supplied with a moulded plug incorporating a fuse. The value of the fuse is indicated on the pin face of the plug and if it requires replacing, a fuse approved to BS1362 of the same rating must be used.

Never use the plug with the fuse cover removed. If the cover is detachable and a replacement is required, it must be of the same colour as the fuse fitted in the plug. Replacement covers are available from your dealer. If the fitted plug is not suitable for the power points in your house or the cable is not long enough to reach a power point, you should obtain a suitable safety approved extension lead or consult your dealer for assistance.

However, if there is no alternative to cutting off the plug, remove the fuse and then safely dispose of the plug. Do not connect the plug to a mains socket as there is a risk of shock hazard from the bared flexible cord. Never attempt to insert bare wires directly into a mains socket. A plug and fuse must be used at all times.

IMPORTANT

The wires in the mains lead are coloured in accordance with the following code:– BLUE = NEUTRAL BROWN = LIVE As these colours may not correspond to the coloured markings identifying the terminals in your plug, proceed as follows:– The wire coloured BLUE must be connected to the terminal marked with the letter N or coloured BLUE or BLACK. The wire coloured BROWN must be connected to the terminal marked with the letter L or coloured BROWN or RED.

WARNING : DO NOT CONNECT EITHER WIRE TO THE EARTH TERMINAL WHICH IS MARKED WITH THE LETTER E OR BY THE EARTH SYMBOL , OR COLOURED GREEN OR GREEN AND YELLOW.

PRECAUTIONS

1. Ensure that the AC power supply in your house complies with the power requirements listed on the identification sticker located on the bottom of your product. Install your product horizontally, on a suitable base (furniture), with enough space around it for ventilation (7-10 cm). Make sure the ventilation slots are not covered. Do not place the unit on amplifiers or other equipment which may become hot. This unit is designed for continuous use. To fully turn off the unit, disconnect the AC plug from the wall outlet. Unplug the unit if you intend to leave it unused for a long period of time.
2. During thunderstorms, disconnect the AC plug from the wall outlet. Voltage peaks due to lightning could damage the unit.
3. Do not expose the unit to direct sunlight or other heat sources. This could lead to overheating and cause the unit to malfunction.
4. Protect the product from moisture (i.e. vases), and excess heat (e.g. a fireplace) or equipment creating strong magnetic or electric fields. Unplug the power cable from the AC wall socket if the unit malfunctions. Your product is not intended for industrial use. It is for personal use only. Condensation may occur if your product has been stored in cold temperatures. If transporting the unit during the winter, wait approximately 2 hours until the unit has reached room temperature before using.
5. **Fire or explosion may occur, resulting in damage to the remote control or personal injury.**
 - Do not apply shock to the remote control.
 - Be careful not to let foreign substances such as metal, liquid, or dust come in contact with the charging terminal of the remote control.
 - When the remote control is damaged or you smell smoke or burning fumes, immediately stop operation and then repair it at the Samsung service centre.
 - Do not arbitrarily disassemble the remote control.
 - Be careful not to let infants or pets suck or bite the remote control. Fire or explosion may occur, resulting in damage to the remote control or personal injury.

CONTENTS

01	Checking the Components	6
02	Product Overview	7
	Top Panel of the Soundbar	7
	Rear Panel of the Soundbar	8
03	Using the Soundbar Remote Control	9
	About the Remote control	9
	How to Use the Remote Control	9
	Active Voice Amplifier (AVA)	11
	Using the Hidden Buttons (Buttons with more than one function)	11
	Output specifications for the different sound effect modes	12
	Adjusting the Soundbar volume with a TV remote control	13
04	Connecting the Soundbar	14
	Connecting the power and units	14
	– Manually connecting the Subwoofer	15
	– LED Indicator Lights on the Rear of Subwoofer	16
	Connecting an SWA-9500S (Sold Separately) to your Soundbar	16
05	Connecting to a TV	17
	Connecting the TV that supports HDMI ARC (Audio Return Channel)	17
	Connecting via Bluetooth	18
	Connecting via Wi-Fi	19
	Connecting to a TV that supports Dolby Atmos	20
	Using the Q-Symphony Function	21
	Using the Spacefit sound	22
06	Connecting a Mobile Device	23
	Method 1. Connecting via Bluetooth	23
	Method 2. Connecting via Wi-Fi (Wireless Network)	25
	Using the Tap Sound	26
07	Connecting via Apple Airplay 2	27
08	Installing the Wall Mount	28
	Installation Precautions	28
	Wallmount Components	28
09	Installing the Soundbar in front of TV	29

10	Software Update	30
	Auto Update.....	30
	USB Update.....	30
	Reset.....	30
11	Troubleshooting	31
12	Licence	32
13	Open Source Licence Notice	33
14	Important Notes About Service	33
15	Specifications and Guide	34
	Specifications.....	34



01 CHECKING THE COMPONENTS

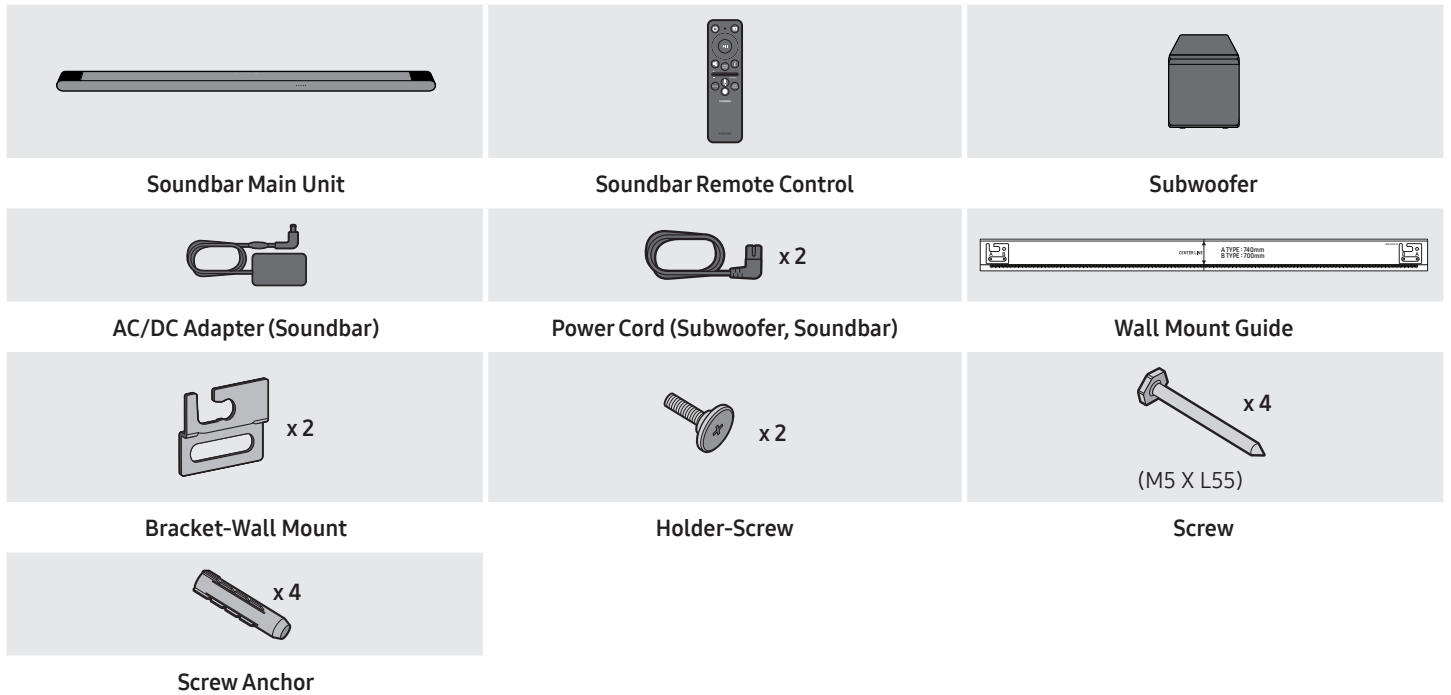







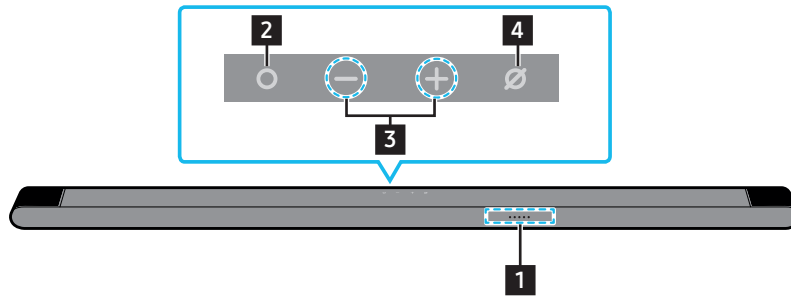

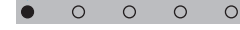
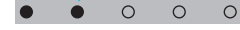

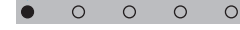
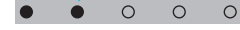

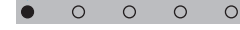
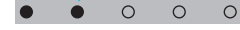
- For more information about the power supply and power consumption, refer to the label attached to the product. (Label: Bottom of the Soundbar Main Unit)
- To purchase additional components or optional cables, contact a Samsung Service Centre or Samsung Customer Care.
- For more information about the wallmount or rubber-foot, see pages 28~29.
- Design, specifications, and App screen are subject to change without prior notice.
- The appearance of the accessories may differ slightly from the illustrations above.

02 PRODUCT OVERVIEW

Top Panel of the Soundbar



<p>1</p>	<p>LED indicator The LED Indicator flashes, glows, or changes colour depending on the Soundbar's current mode or status. The colour of the LED indicator and the number of lights indicate the active mode as described below.</p> <table border="1" data-bbox="151 689 1508 779"> <tr> <td style="text-align: center;">Ⓜ</td> <td style="text-align: center;">Ⓜ</td> <td style="text-align: center;">Ⓜ</td> <td style="text-align: center;">Ⓜ</td> <td style="text-align: center;">Ⓜ</td> </tr> <tr> <td style="text-align: center;">White LED</td> <td style="text-align: center;">White LED</td> <td style="text-align: center;">Multicolour LED</td> <td style="text-align: center;">White LED</td> <td style="text-align: center;">White LED</td> </tr> </table> <ul style="list-style-type: none"> The Multicolour LED changes to White, Cyan, Green, Red, and Blue depending on the mode or status. 	Ⓜ	Ⓜ	Ⓜ	Ⓜ	Ⓜ	White LED	White LED	Multicolour LED	White LED	White LED
Ⓜ	Ⓜ	Ⓜ	Ⓜ	Ⓜ							
White LED	White LED	Multicolour LED	White LED	White LED							
<p>2</p>	<p>○ (Multi Function) Button</p> <ul style="list-style-type: none"> In standby mode, press the ○ (Multi Function) button to turn on the Soundbar. Press the ○ (Multi Function) button to change the mode. Each time you change the mode, the LED lights in white and then turns off. <table border="1" data-bbox="151 958 1508 1120"> <tr> <td style="text-align: center;">LED indicator</td> <td style="text-align: center;"> <div style="border: 1px solid blue; padding: 2px;">White On → Off</div>  </td> <td style="text-align: center;"> <div style="border: 1px solid blue; padding: 2px;">White On → Off</div>  </td> <td style="text-align: center;"> <div style="border: 1px solid blue; padding: 2px;">White On → Off</div>  </td> </tr> <tr> <td style="text-align: center;">🔊</td> <td style="text-align: center;">"TV ARC"</td> <td style="text-align: center;">"Wi-Fi"</td> <td style="text-align: center;">"Bluetooth"</td> </tr> </table>	LED indicator	<div style="border: 1px solid blue; padding: 2px;">White On → Off</div> 	<div style="border: 1px solid blue; padding: 2px;">White On → Off</div> 	<div style="border: 1px solid blue; padding: 2px;">White On → Off</div> 	🔊	"TV ARC"	"Wi-Fi"	"Bluetooth"		
LED indicator	<div style="border: 1px solid blue; padding: 2px;">White On → Off</div> 	<div style="border: 1px solid blue; padding: 2px;">White On → Off</div> 	<div style="border: 1px solid blue; padding: 2px;">White On → Off</div> 								
🔊	"TV ARC"	"Wi-Fi"	"Bluetooth"								
<p>3</p>	<p>— + (Volume) Button Adjusts the volume.</p>										
<p>4</p>	<p>⊘ (Mic On/Off) Button Press the button to turn the microphone on or off. When the microphone is off, the LED indicator will light red.</p> <table border="1" data-bbox="151 1348 1157 1512"> <tr> <td style="text-align: center;">LED indicator</td> <td style="text-align: center;"> <div style="border: 1px solid blue; padding: 2px;">Red On</div>  </td> <td style="text-align: center;">  </td> </tr> <tr> <td style="text-align: center;">🔊</td> <td style="text-align: center;">"Mic Off"</td> <td style="text-align: center;">"Mic On"</td> </tr> </table>	LED indicator	<div style="border: 1px solid blue; padding: 2px;">Red On</div> 		🔊	"Mic Off"	"Mic On"				
LED indicator	<div style="border: 1px solid blue; padding: 2px;">Red On</div> 										
🔊	"Mic Off"	"Mic On"									

- When you plug in the AC cord, the power button will begin working in 4 to 6 seconds.
- When you turn on this unit, there will be a 4 to 5 second delay before it produces sound.
- If you hear sounds from both the TV and Soundbar, go to the **Settings** menu for the TV audio and change the TV speaker to **External Speaker**.
- You can turn on and off audio feedback by using **SmartThings** app. To learn about using the **SmartThings** app, refer to "**Method 2. Connecting via Wi-Fi (Wireless Network)**".



Rear Panel of the Soundbar

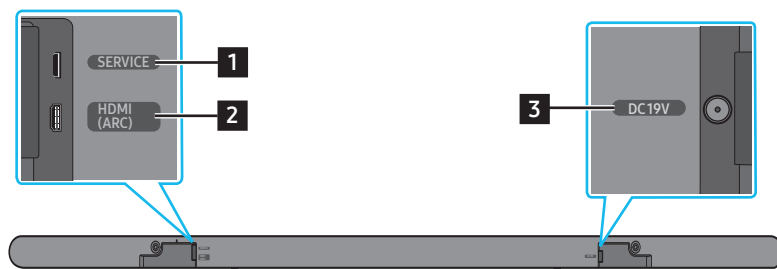

1	SERVICE Connect a USB storage device to upgrade the product's software.
2	HDMI (ARC) Connect to the HDMI (ARC) port on a TV. (See page 17)
3	DC 19V Connect the AC/DC power adapter. (Power Supply In) (See page 14)

- When disconnecting the power cable of the AC/DC power adaptor from a wall outlet, pull the plug. Do not pull the cable.
- Do not connect this unit or other components to an AC outlet until all connections between components are complete.

03 USING THE SOUNDBAR REMOTE CONTROL





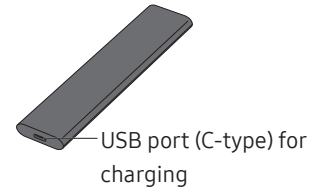

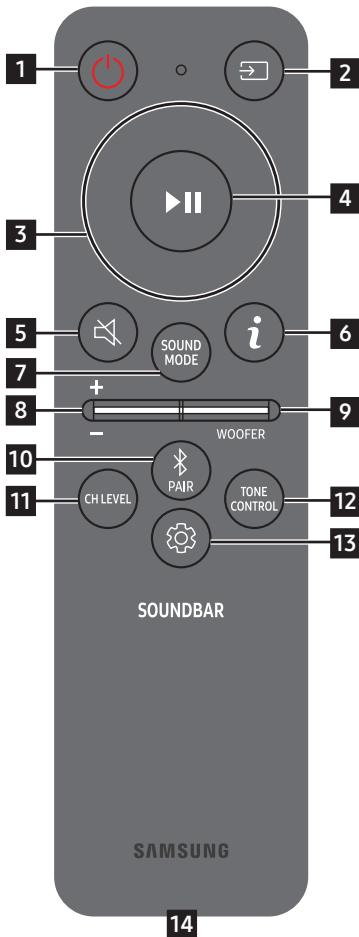

About the Remote control



















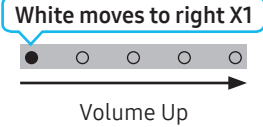
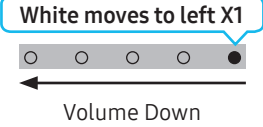
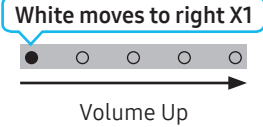
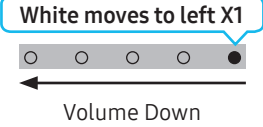
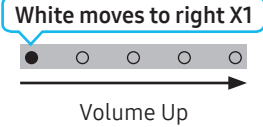
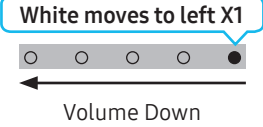

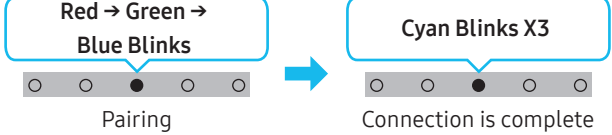

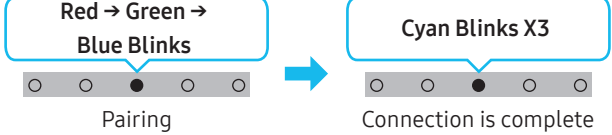
- Use the Remote less than 6 m from the product. The usable distance may vary with the wireless environmental conditions.
- When the remote control does not work due to low battery, charge it by using the USB-C type port.
- The illustration differs with the respective Remote Control model.

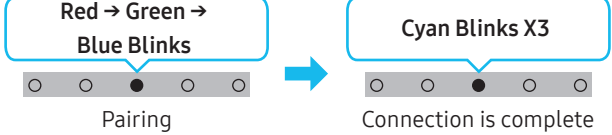















How to Use the Remote Control



<p>1</p>	 Power	<p>Turns the Soundbar on and off.</p> <table border="1" data-bbox="774 593 1516 728"> <tr> <td data-bbox="774 593 925 728">LED indicator</td> <td data-bbox="925 593 1220 728"> <p>Cyan Blinks X1 On</p> </td> <td data-bbox="1220 593 1516 728"> <p>Red Blinks X3 Off</p> </td> </tr> </table> <ul style="list-style-type: none"> • Auto Power Down Function The unit turns off automatically in the following situations: <ul style="list-style-type: none"> • In "TV ARC" / "Wi-Fi" / "Bluetooth" mode if there is no audio signal for 18 minutes. 	LED indicator	<p>Cyan Blinks X1 On</p>	<p>Red Blinks X3 Off</p>
LED indicator	<p>Cyan Blinks X1 On</p>	<p>Red Blinks X3 Off</p>			
<p>2</p>	 Source	<p>Press to select a source connected to the Soundbar.</p> <ul style="list-style-type: none"> • Audio Feedback On/Off You can turn on or off the Audio Feedback. Press and hold the  (Source) button on the remote control for 5 seconds while the Soundbar is off (Standby mode). <table border="1" data-bbox="774 1064 1516 1198"> <tr> <td data-bbox="774 1064 925 1198">LED indicator</td> <td data-bbox="925 1064 1220 1198"> <p>Cyan Blinks X1 On</p> </td> <td data-bbox="1220 1064 1516 1198"> <p>Red Blinks X1 Off</p> </td> </tr> </table>	LED indicator	<p>Cyan Blinks X1 On</p>	<p>Red Blinks X1 Off</p>
LED indicator	<p>Cyan Blinks X1 On</p>	<p>Red Blinks X1 Off</p>			
<p>3</p>	 Up/Down/Left/Right	 <p>Press the indicated areas to select Up/Down/Left/Right.</p> <p>Press Up/Down/Left/Right on the button to select or set functions.</p> <ul style="list-style-type: none"> • Music Skip Press the Right button to select the next music file. Press the Left button to select the previous music file. • ID SET Press and hold the Up button for 5 seconds to complete ID SET (when connecting to a wireless subwoofer or wireless rear speakers). 			
<p>4</p>	 Play / Pause	<p>You can also play or pause music by pressing the button.</p>			
<p>5</p>	 Mute	<p>Press the  (Mute) button to mute the sound. Press it again to unmute the sound.</p> <table border="1" data-bbox="774 1825 1516 1926"> <tr> <td data-bbox="774 1825 925 1926">LED indicator</td> <td data-bbox="925 1825 1516 1926"> <p>Blinks X Repeatedly</p> </td> </tr> </table>	LED indicator	<p>Blinks X Repeatedly</p>	
LED indicator	<p>Blinks X Repeatedly</p>				



6	 Info	<p>Press the button to display information about the current function. (See page 7) When connected to Dolby Atmos®, the LED indicator blinks cyan 3 times.</p>				
7	 SOUND MODE	<p>By pressing the button, you can select the desired audio mode. Each time the mode changes, the Multicolour LED blinks in white.</p> <table border="1" data-bbox="370 286 1375 459"> <tr> <td data-bbox="370 286 676 383">LED indicator</td> <td data-bbox="676 286 1375 383">  </td> </tr> <tr> <td data-bbox="370 383 676 459">  </td> <td data-bbox="676 383 1375 459"> <p>“Surround” → “Game” → “Standard” → “Adaptive Sound” → “DTS Virtual:X”</p> </td> </tr> </table> <ul style="list-style-type: none"> • Surround Provides a wider sound field than standard. • Game Provides stereoscopic sound to immerse you in the action while gaming. • Standard Outputs the original sound. • Adaptive Sound Analyzes the content in real time and automatically provides the optimal sound field based on the characteristics of the content. • DTS Virtual:X Immersive 3D sound from any content. 	LED indicator			<p>“Surround” → “Game” → “Standard” → “Adaptive Sound” → “DTS Virtual:X”</p>
LED indicator						
	<p>“Surround” → “Game” → “Standard” → “Adaptive Sound” → “DTS Virtual:X”</p>					
8	 VOLUME	<p>Push the button up or down to adjust the volume.</p> <table border="1" data-bbox="370 907 1375 1057"> <tr> <td data-bbox="370 907 676 1057">LED indicator</td> <td data-bbox="676 907 1024 1057">  </td> <td data-bbox="1024 907 1375 1057">  </td> </tr> </table>	LED indicator			
LED indicator						
9	 WOOFER (BASS) LEVEL	<p>Push the button up or down to adjust the level of the woofer (bass) to -12 or between -6 to +6. To set the woofer (bass) volume level to 0 (Default), press the button.</p>				
10	 Bluetooth PAIR	<p>Switch the Soundbar to Bluetooth pairing mode. When you press the button, the LED display changes as shown below.</p> <ul style="list-style-type: none"> • Until pairing is complete, the Multicolour LED changes as Red → Green → Blue in turn. <table border="1" data-bbox="370 1332 1375 1556"> <tr> <td data-bbox="370 1332 676 1489">LED indicator</td> <td data-bbox="676 1332 1375 1489">  </td> </tr> <tr> <td data-bbox="370 1489 676 1556">  </td> <td data-bbox="676 1489 1375 1556"> <p>“Ready to connect via Bluetooth.”</p> </td> </tr> </table>	LED indicator			<p>“Ready to connect via Bluetooth.”</p>
LED indicator						
	<p>“Ready to connect via Bluetooth.”</p>					
11	 CH LEVEL	<p>By pressing the button, you can adjust the volume of the each speaker.</p> <ul style="list-style-type: none"> • To control the volume of the each speaker select “Centre Level” or “Front Top Level” in Sound Settings, and then adjust the volume between -6~+6 by using the Up/Down buttons. • If the Rear Speakers (sold separately) are connected, the setting “Rear Level” and “Rear Top Level” is supported. To adjust the volume of the “Rear Level” and “Rear Top Level” between -6 to +6 by using the Up/Down buttons. <table border="1" data-bbox="370 1796 1375 1953"> <tr> <td data-bbox="370 1796 676 1892">LED indicator</td> <td data-bbox="676 1796 1375 1892">  </td> </tr> <tr> <td data-bbox="370 1892 676 1953">  </td> <td data-bbox="676 1892 1375 1953"> <p>“Centre Level” → “Front Top Level”</p> </td> </tr> </table>	LED indicator			<p>“Centre Level” → “Front Top Level”</p>
LED indicator						
	<p>“Centre Level” → “Front Top Level”</p>					

12	 TONE CONTROL	<p>By pressing the button, you can adjust the volume of the treble or bass sound. The defined item can be adjusted using the Up/Down buttons. This function is enabled in Sound mode excluding in Standard mode.</p> <ul style="list-style-type: none"> To control the volume of the treble or bass sound, select “Treble” or “Bass” in Sound Settings, and then adjust the volume between -6~+6 by using the Up/Down buttons. Once the bass level is changed, the woofer level will be also adjusted accordingly. <table border="1" data-bbox="371 271 1374 432"> <tr> <td data-bbox="371 271 676 367">LED indicator</td> <td data-bbox="676 271 1374 367">  </td> </tr> <tr> <td data-bbox="371 367 676 432">  </td> <td data-bbox="676 367 1374 432">“Treble” → “Bass”</td> </tr> </table>	LED indicator			“Treble” → “Bass”
LED indicator						
	“Treble” → “Bass”					
13	 Sound Control	<p>By pressing the button, you can set the audio function. The desired item can be adjusted using the Up/Down buttons. Each time the mode changes, the Multicolour LED blinks in white.</p> <table border="1" data-bbox="371 539 1374 712"> <tr> <td data-bbox="371 539 676 636">LED indicator</td> <td data-bbox="676 539 1374 636">  </td> </tr> <tr> <td data-bbox="371 636 676 712">  </td> <td data-bbox="676 636 1374 712">“SpaceFit Sound” → “Active Voice Amplifier” → “Voice enhancement” → “Night Mode” → “Sync” → “Virtual”</td> </tr> </table> <ul style="list-style-type: none"> Voice enhancement makes it easier to hear spoken dialog in movies and TV. Night Mode is optimized for night time viewing with the settings adjusted to bring the volume down but keep the dialog clear. Press and hold the  (Sound Control) button for about 5 seconds to adjust the sound for each frequency band. 150Hz, 300Hz, 600Hz, 1.2kHz, 2.5kHz, 5kHz, and 10kHz are selectable using the Left/Right buttons and each can be adjusted to a setting between -6 to +6 using the Up/Down buttons. (Make sure the Sound mode is set to “STANDARD”.) If the video on the TV and audio from the Soundbar are not synchronized, select “Sync” in Sound Control, and then set the audio delay between 0~300 milliseconds by using the Up/Down buttons. “Sync” is only supported for some functions. The Virtual function can be turned On/Off by using the Up/Down buttons. 	LED indicator			“SpaceFit Sound” → “Active Voice Amplifier” → “Voice enhancement” → “Night Mode” → “Sync” → “Virtual”
LED indicator						
	“SpaceFit Sound” → “Active Voice Amplifier” → “Voice enhancement” → “Night Mode” → “Sync” → “Virtual”					
14	USB port (C-type) for charging	<p>The LED lights while charging. When fully charged, the LED turns off.</p> <ul style="list-style-type: none"> The USB Cable is not provided. When the remote control does not work due to low battery, charge it by using the USB-C type port. 				

Active Voice Amplifier (AVA)

- Analyzes external noise in real time while soundbar is playing, so that voice audio can always be heard clearly.
- No data is saved during the analysis.

Using the Hidden Buttons (Buttons with more than one function)

Hidden Button		Reference page
Remote Control Button	Function	
WOOFER (Up)	TV remote control On/Off (Standby)	page 13
Up	ID SET	page 9
 (Sound Control)	7 Band EQ	page 11
 (Source)	Audio Feedback On/Off (Standby)	page 9

Output specifications for the different sound effect modes

Effect	Input	Output	
		With Subwoofer Only	With Subwoofer & Wireless Rear Speaker Kit
Surround	2.0 ch	3.1.2 ch	5.1.4 ch
	5.1 ch	3.1.2 ch	5.1.4 ch
	Dolby Atmos®	3.1.2 ch	5.1.4 ch
Game	2.0 ch	3.1.2 ch	5.1.4 ch
	5.1 ch	3.1.2 ch	5.1.4 ch
	Dolby Atmos®	3.1.2 ch	5.1.4 ch
Standard	2.0 ch	2.1 ch	2.1 ch
	5.1 ch	3.1 ch	5.1 ch
	Dolby Atmos®	3.1.2 ch	5.1.4 ch
Adaptive Sound	2.0 ch	3.1.2 ch	5.1.4 ch
	5.1 ch	3.1.2 ch	5.1.4 ch
	Dolby Atmos®	3.1.2 ch	5.1.4 ch
DTS Virtual:X	2.0 ch	3.1.2 ch	5.1.4 ch
	5.1 ch	3.1.2 ch	5.1.4 ch
	Dolby Atmos®	3.1.2 ch	5.1.4 ch

- The Samsung Wireless Rear Speaker Kit can be purchased separately. To purchase a Kit, contact the vendor you purchases the Soundbar from.
- The Surround Speakers will not produce sounds for 2 channel output while **STANDARD** mode is in use. To enable sound for the Surround Speakers, change the effect mode to **SURROUND**.
- When the input source is Dolby Atmos® the Subwoofer-only setup provides 3.1.2 channel audio, while the Subwoofer & Wireless Rear Speaker Kit setup provides 5.1.4 channel audio.

Adjusting the Soundbar volume with a TV remote control







Adjust the Soundbar volume using the TV's remote control.

- This function can be used with IR remote controls only. Bluetooth remote controls (remote controls that require pairing) are not supported.
- Set the TV speaker to **External Speaker** to use this function.
- Manufacturers supporting this function:
Samsung, VIZIO, LG, Sony, Sharp, PHILIPS, PANASONIC, TOSHIBA, Hisense, RCA

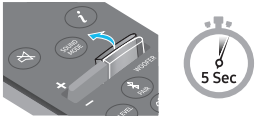
1. Turn Off the Soundbar.

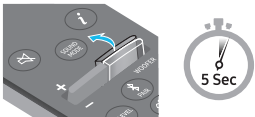
2. Push up and hold the **WOOFER** button for 5 seconds.

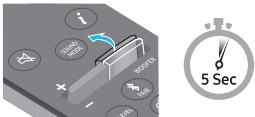
Each time you push the **WOOFER** button up and hold it for 5 seconds, the mode switches in the following order: "OFF-TV REMOTE" (Default mode), "SAMSUNG-TV REMOTE", "ALL-TV REMOTE".

Remote Control Button	LED Indicator	Status
	(Default mode) Red Blinks X1  "Off-TV Remote" (Default mode)	Disable the TV remote control.
	Cyan Blinks X1  "Samsung-TV Remote"	Enable a Samsung TV's IR remote control.
	Blue Blinks X1  "All-TV Remote"	Enable a third-party TV's IR remote control.

04 CONNECTING THE SOUNDBAR

Connecting the power and units

Use the Power cord to connect the Subwoofer and Soundbar to an electrical outlet in the following order:

- For more information about the required electrical power and power consumption, refer to the label attached to the product. (Label: Bottom of the Soundbar Main Unit)

1. Connect the Power cord to the Subwoofer.

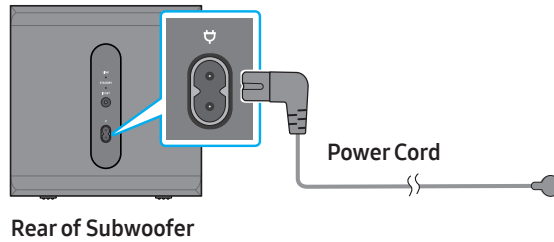

2. Connect the Power cord to the Soundbar.

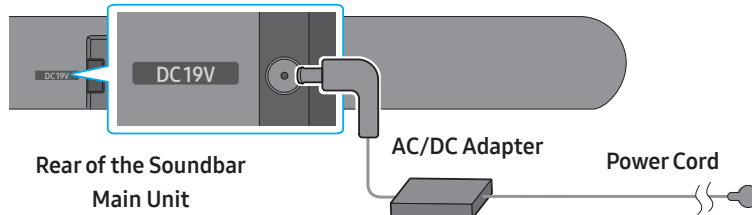

3. Connect power to the Soundbar and Subwoofer. The Subwoofer is automatically connected when the Soundbar is turned on.

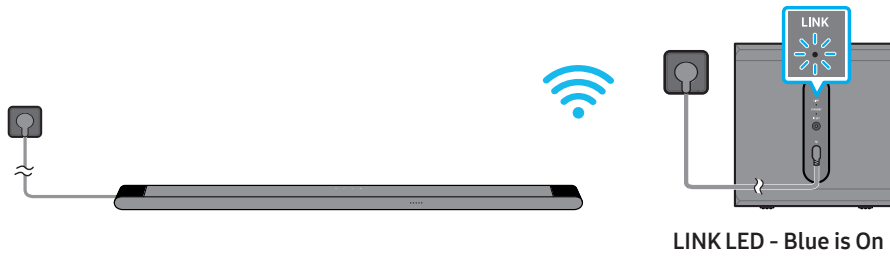

NOTE

- Connect the Subwoofer power before connecting to the Soundbar. The Subwoofer will be automatically connected when turning on the Soundbar.
- If you unplug and reconnect the power cord when the product is turned on, the Soundbar turns on automatically.

Manually connecting the Subwoofer

Before performing the manual connection procedure below:

- Check whether the power cables for the Soundbar and subwoofer is connected properly.
- Make sure that the Soundbar is turned off.

1. Turn off the Soundbar main.
2. Press and hold **ID SET** on the rear of the subwoofer for at least 5 seconds.
 - The red indicator at the rear of each speaker turns off and the blue indicator blinks.

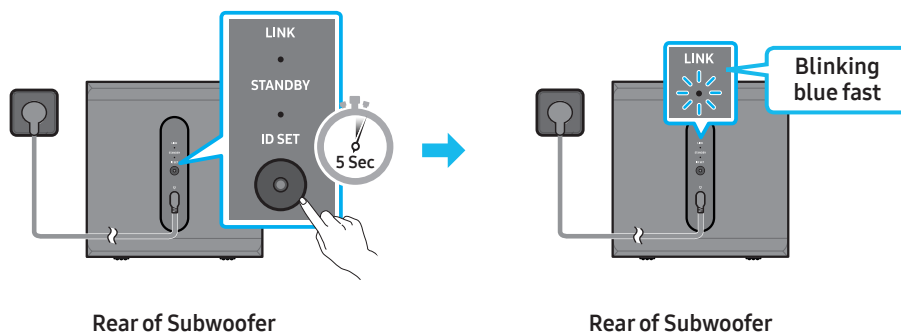

3. Press the **Up** button on the remote control for 5 seconds.
 - The Soundbar will automatically power on when **ID SET** is complete.

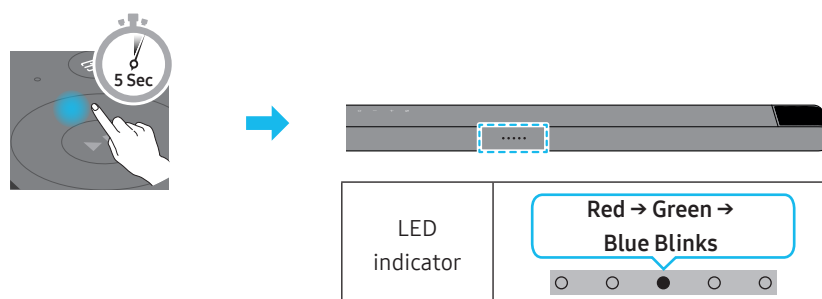

4. Check if the LINK LED is solid blue (connection complete).

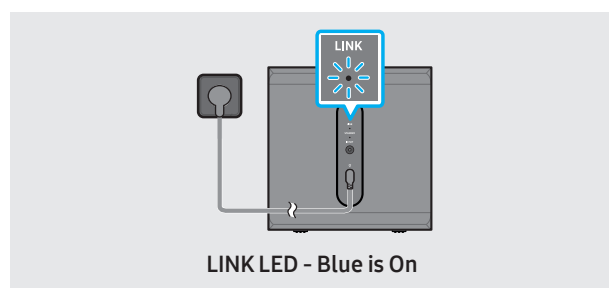

The LINK LED indicator stops blinking and glows a solid blue when a connection is established between the Soundbar and the Wireless Subwoofer.

LED Indicator Lights on the Rear of Subwoofer

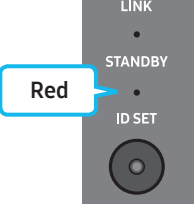
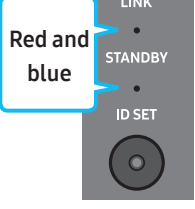
LED	Status	Description	Resolution
	On	Successfully connected (normal operation)	-
	Blinking	Recovering the connection	Check if the power cable attached to the main Soundbar unit is connected properly or wait about 5 minutes. If blinking persists, try manually connecting the subwoofer. See page 15.
	On	Standby (with the Soundbar main unit turned off)	Check if the power cable attached to the main Soundbar unit is connected properly.
		Connection failed	Connect again. See the instructions for manual connection on page 15.
	Blinking	Malfunction	See the contact information for the Samsung Service Centre in this manual.

NOTE

- If the main unit is powered off, the wireless subwoofer will go into stand-by mode and the STANDBY LED on the rear of the sub-woofer will turn red after blinking in blue several times.
- If you use a device that uses the same frequency as the Soundbar near the Soundbar, interference may cause some sound interruption.
- The maximum transmission distance of the main unit's wireless signal is about 10 m, but may vary depending on your operating environment. If a steel-concrete or metallic wall is between the main unit and the wireless subwoofer, the system may not operate at all because the wireless signal cannot penetrate metal.

CAUTION

- Wireless receiving antennas are built into the wireless subwoofer. Keep the unit away from water and moisture.
- For optimal listening performance, make sure that the area around the wireless subwoofer is clear of any obstructions.

Connecting an SWA-9500S (Sold Separately) to your Soundbar

Expand to true wireless surround sound by connecting the Samsung Wireless Rear Speaker Kit (SWA-9500S, sold separately) to your Soundbar. For detailed information on connections, see the Samsung Wireless Rear Speaker Kit manual.

05 CONNECTING TO A TV

Connecting the TV that supports HDMI ARC (Audio Return Channel)

⚠ CAUTION

- When using an HDMI to MINI HDMI cable, take caution not to break the cable terminal.
- When the HDMI cable is connected, the HDMI signal is received first.
- To connect the HDMI cable between the TV and Soundbar, be sure to connect the terminals marked ARC. Otherwise, the TV sound may not be output.
- The recommended cable is **High Speed HDMI Cable with Ethernet**.

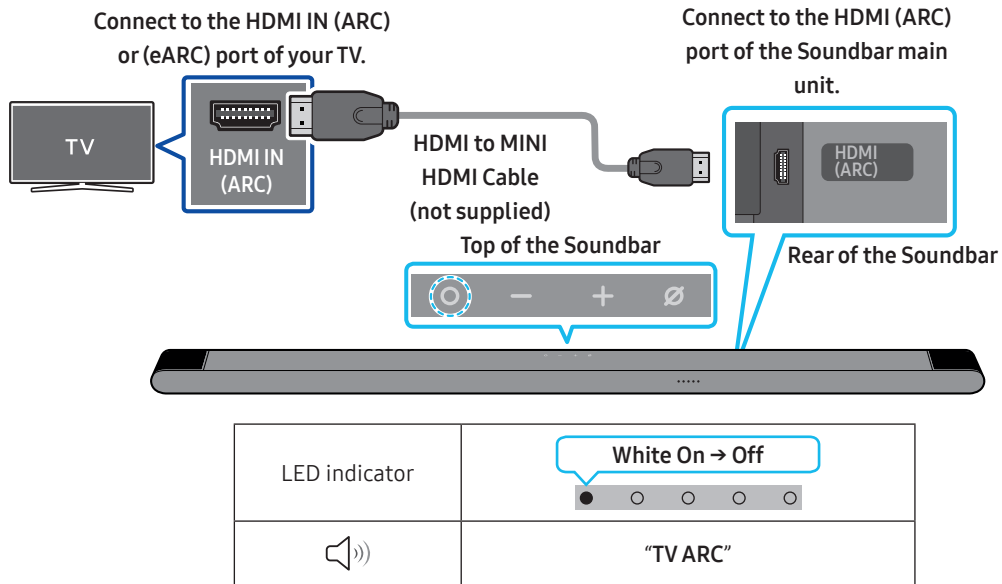

1. With the Soundbar and TV turned off, connect the HDMI cable (not supplied) as shown in the figure.
2. Turn on the Soundbar and TV.
3. Your TV will output sound via the Soundbar.
 - When the TV sound is not output, press the **○ (Multi Function)** button at the top of the Soundbar or the **📺 (Source)** button on the remote control to select the "TV ARC" mode.
 - When the sound is not output, check the HDMI cable (not supplied) connection again.
 - Use the volume buttons on the TV's remote control to change the volume on the Soundbar.

NOTE

- We recommend you use a coreless HDMI cable if possible. If you use a cored HDMI cable, use one whose diameter is less than 14 mm.
- This function is not available if the HDMI cable does not support ARC.
- When the audio in a broadcast is encoded in Dolby Digital and the "Digital Output Audio Format" on your TV is set to PCM, we recommend that you change the setting to Dolby Digital. When the setting on the TV is changed, you will experience better sound quality. (The TV menu may use different words for Dolby Digital and PCM depending on the TV manufacturer.)





Connecting via Bluetooth

When a Samsung TV is connected using Bluetooth, you can hear stereo sound without the hassle of cabling.

- Only one Samsung TV can be connected at a time.
- Samsung TV that supports Bluetooth can be connected. Check the specifications of your TV.

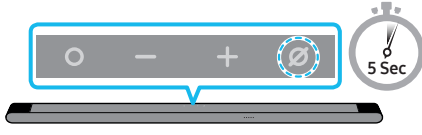

The initial connection

<p>1. Bluetooth Pairing button</p>  <p>(OR)</p> <p>When in "Bluetooth" mode</p> 	<p>LED Indicator</p> <div style="display: flex; align-items: center; justify-content: center;"> <div style="border: 1px solid cyan; padding: 5px; margin-right: 20px;">Red → Green → Blue Blinks</div> <div style="font-size: 2em; margin: 0 10px;">➔</div> <div style="border: 1px solid cyan; padding: 5px;">Cyan Blinks X3</div> </div> <div style="display: flex; justify-content: space-around; margin-top: 10px;"> <div style="text-align: center;">  <p>Pairing</p> </div> <div style="text-align: center;">  <p>Connection is complete</p> </div> </div> <ul style="list-style-type: none"> • Until pairing is complete, the Multicolour LED changes as Red → Green → Blue in turn. <div style="display: flex; align-items: center; justify-content: center; margin-top: 20px;">  <p>"Ready to connect via Bluetooth."</p> </div>
---	---

2. Select Bluetooth mode on the Samsung TV.
(e.g. Home (🏠) → Menu → Settings (⚙️) → All Settings (⚙️) → Sound → Sound Output → Bluetooth Speaker List → [AV] Samsung Soundbar S***B (Bluetooth))
3. Select "[AV] Samsung Soundbar S***B" from the list on TV's screen.
An available Soundbar is indicated with "Need Pairing" or "Paired" on the TV's Bluetooth device list. To connect the Samsung TV to the Soundbar, select the message, and then establish a connection.
4. You can now hear Samsung TV sound from the Soundbar.

If the device fails to connect

- If you have an existing Soundbar (e.g., [AV] Samsung Soundbar S***B) on the list of speakers on the Samsung TV, delete it.
- Then repeat steps 1 through 3.

Disconnecting the Soundbar from the Samsung TV

Press the **○ (Multi Function)** button at the top of the Soundbar or the **➡ (Source)** button on the remote control to select the mode other than "Bluetooth".

- Disconnecting takes time because the Samsung TV must receive a response from the Soundbar.
(The time required may differ, depending on the Samsung TV model.)

Notes on Bluetooth connection

- Locate a new device within 1 m to connect via Bluetooth communication.
- If asked for a PIN code when connecting a Bluetooth device, enter <0000>.
- The Soundbar automatically turns off after 18 minutes in the Ready state.
- The Soundbar may not perform Bluetooth search or connection correctly under the following circumstances:
 - If there is a strong electrical field around the Soundbar.
 - If several Bluetooth devices are simultaneously paired with the Soundbar.
 - If the Bluetooth device is turned off, not in place, or malfunctions.
- Electronic devices may cause radio interference. Devices that generate electromagnetic waves must be kept away from the Soundbar main unit - e.g., microwaves, wireless LAN devices, etc.

Connecting via Wi-Fi

Pre-connection Checklist

- Wi-Fi connection is available only on Samsung TV.
- Check whether **the wireless router (Wi-Fi)** is turned on and **the TV is connected to the router**.
- The TV and Soundbar must be connected to the same wireless network (Wi-Fi).
- If your wireless router (Wi-Fi) uses a DFS channel, you will not be able to establish a Wi-Fi connection between the TV and Soundbar. Contact your Internet service provider for details.
- Because the menus may differ depending on the year of manufacture, refer to your TV manual.
- To connect the TV to the Soundbar via Wi-Fi, connect the Soundbar to the wireless router first. See page 25, for details on how to establish a Wi-Fi connection.

1. For more information about Wi-Fi connection to the Soundbar, see page 25, "**Method 2. Connecting via Wi-Fi (Wireless Network)**".
2. Change the input source of the TV by using the Audio menu to Soundbar.
 - **Samsung TVs released in 2017 or later**
Sound → Sound Output → [AV] Samsung Soundbar S***B (Wi-Fi)

Connecting to a TV that supports Dolby Atmos

Pre-connection Checklist

- Dolby Atmos® is supported in “TV ARC” or “Wi-Fi” mode.
- Make sure that the content supports Dolby Atmos®.

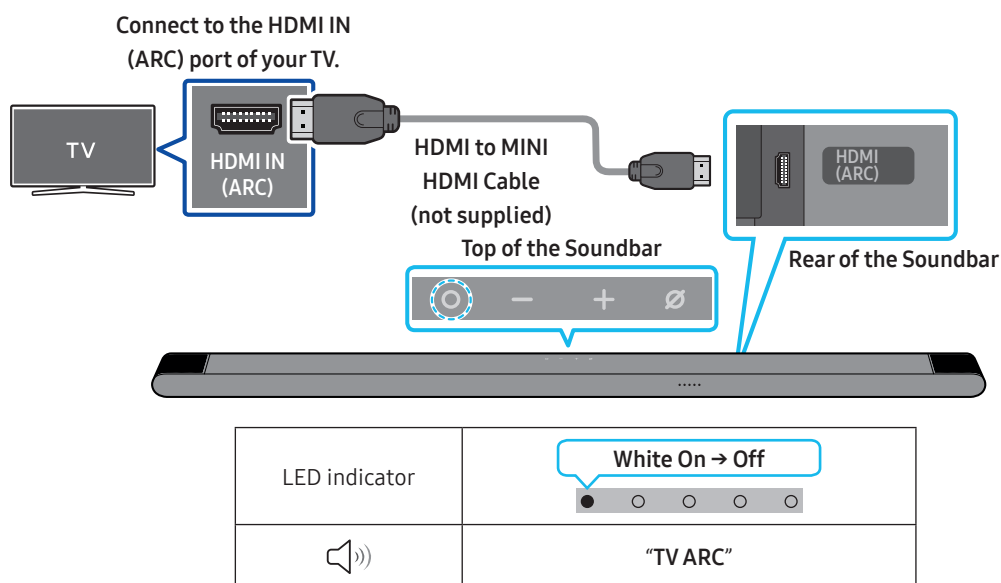

1. With the Soundbar and TV turned off, connect the HDMI cable (not supplied) as shown in the figure.
2. Turn on the Soundbar and TV.
3. TV sound is output from the Soundbar.

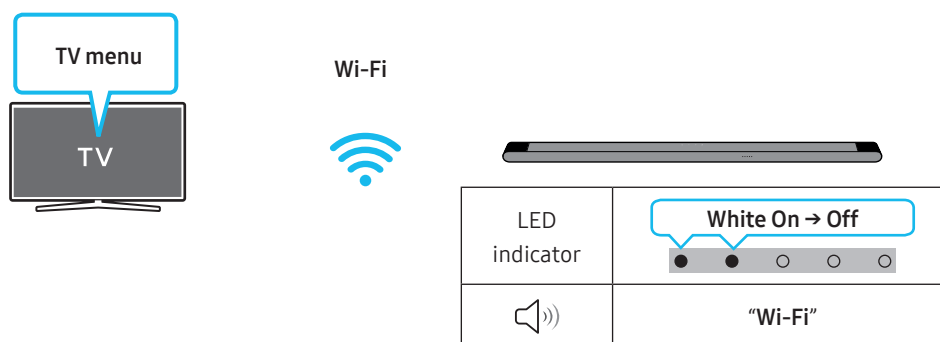

1. Connect the Soundbar and TV to the same wireless network (Wi-Fi).
2. For sound output of the TV, select Soundbar.
3. TV sound is output from the Soundbar.

NOTE

- **When you use Dolby Atmos®:** If the input source is Dolby Atmos®, refer to “Output specifications for the different sound effect modes” on page 12.
- **Configuring Dolby Atmos® on your BD player or other device connected to the TV.**
Open the audio output options on the settings menu of your BD player or other device and make sure that “No Encoding” is selected for Bitstream. For example, on a Samsung BD Player, go to Home Menu → Sound → Digital Output and then select Bitstream (unprocessed).
- This function is available in some Samsung TVs and some Soundbar models.

Using the Q-Symphony Function

For Q-Symphony, the Soundbar syncs with a Samsung TV to output sound through two devices for optimum surround effect. When the Soundbar is connected, the menu, "TV+Soundbar" appears under the **Sound Output** menu of the TV. Select the corresponding menu.

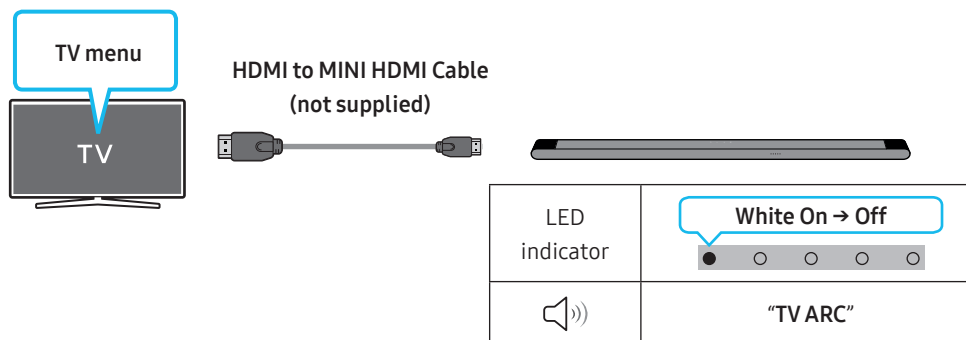

- TV menu example: TV + [AV] Soundbar series name (HDMI)

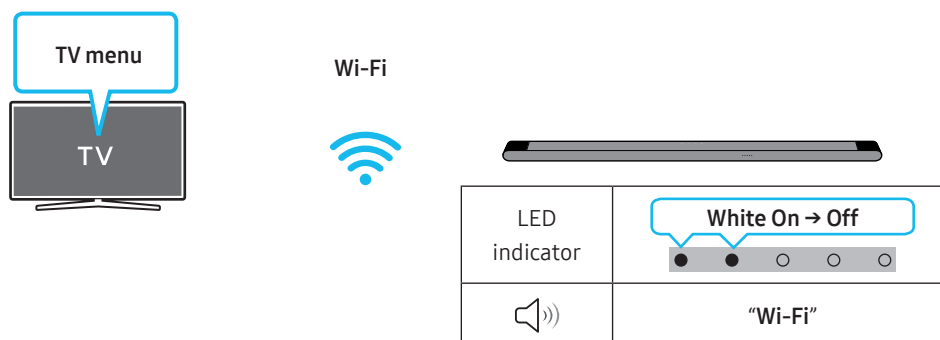

- TV menu example: TV + [AV] Soundbar series name (Wi-Fi)

NOTE



- It can operate according to the Codec supported by TV.
- This function is supported only when the HDMI Cable (not supplied) or Wi-Fi is connected.
- Ensure that your TV and Soundbar are connected to the same wireless router/frequency.
- This function is available in some Samsung TVs and some Soundbar models.

Using the Spacefit sound

Provides optimized sound quality by analyzing the listening spaces.

Method 1. Connecting via Soundbar



To enable this function, turn on the SpaceFit Sound mode with the remote control of the Soundbar.

( (Sound Control) → "SpaceFit Sound Off" →  (Up) → "SpaceFit Sound On")

- This is available in all Sound modes.

Method 2. Connecting via TV

To enable this function, turn on the Adaptive Sound+ mode on your Samsung TV menu.

(Home () → Menu → Settings () → All Settings () → General → Intelligent Mode Settings → Adaptive Sound+)

- The sound mode on your Soundbar will automatically change to **Adaptive Sound+** if you enable the **Adaptive Sound+** mode on your TV.

NOTE

This function works when the Soundbar connects to some of the Samsung TVs.

06 CONNECTING A MOBILE DEVICE

Method 1. Connecting via Bluetooth

When a mobile device is connected using Bluetooth, you can hear stereo sound without the hassle of cabling.

- When you connect a paired Bluetooth device with the Soundbar off, the Soundbar automatically turns on.



The initial connection

When connecting to a new Bluetooth device, make sure the device is within 1 m distance.

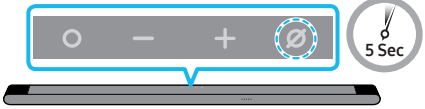
<p>1. Bluetooth Pairing button</p>  <p>(OR)</p> <p>When in "Bluetooth" mode</p> 	<p>LED Indicator</p> <div style="display: flex; align-items: center; justify-content: center;"> <div style="border: 1px solid black; padding: 5px; margin-right: 20px;">Red → Green → Blue Blinks</div> <div style="font-size: 2em; margin-right: 20px;">→</div> <div style="border: 1px solid black; padding: 5px;">Cyan Blinks X3</div> </div> <div style="display: flex; justify-content: center; align-items: center; margin-top: 10px;"> <div style="display: flex; gap: 10px;"> <div style="text-align: center;">○ ○ ● ○ ○ Pairing</div> <div style="font-size: 2em; margin: 0 20px;">→</div> <div style="text-align: center;">○ ○ ● ○ ○ Connection is complete</div> </div> </div> <ul style="list-style-type: none"> • Until pairing is complete, the Multicolour LED changes as Red → Green → Blue in turn. <div style="display: flex; align-items: center; justify-content: center; margin-top: 20px;"> <p>"Ready to connect via Bluetooth."</p> </div>
--	--

2. On your device, select "[AV] Samsung Soundbar S***B" from the list that appears.
3. Play music files from the device connected via Bluetooth through the Soundbar.

If the device fails to connect

- If you have an existing Soundbar (e.g., "[AV] Samsung Soundbar S***B") in the list of speakers on the Mobile device, delete it.
- Repeat steps 1 and 2.

Notes on Bluetooth connection

- Locate a new device within 1 m to connect via Bluetooth communication.
- If asked for a PIN code when connecting a Bluetooth device, enter <0000>.
- The Soundbar automatically turns off after 18 minutes in the Ready state.
- The Soundbar may not perform Bluetooth search or connection correctly under the following circumstances:
 - If there is a strong electrical field around the Soundbar.
 - If several Bluetooth devices are simultaneously paired with the Soundbar.
 - If the Bluetooth device is turned off, not in place, or malfunctions.
- Electronic devices may cause radio interference. Devices that generate electromagnetic waves must be kept away from the Soundbar main unit - e.g., microwaves, wireless LAN devices, etc.
- The Soundbar supports SBC data (44.1kHz, 48kHz).
- Connect only to a Bluetooth device that supports the A2DP (AV) function.
- You cannot connect the Soundbar to a Bluetooth device that supports only the HF (Hands Free) function.
- When connecting the Soundbar to a Bluetooth device, place them as close to each other as possible.
- The farther the Soundbar and Bluetooth device are from each other, the lower the sound quality will become. The Bluetooth connection may break when the devices are out of the effective range.
- The Bluetooth connection may not function as intended in areas with poor reception.

- A Bluetooth device may experience noise or malfunction under in the following conditions:
 - When the body is in contact with the signal transceiver on the Bluetooth device or Soundbar
 - In corners or when there is an obstacle in proximity, such as a wall or partition, where electrical changes may occur.
 - When exposed to radio interferences by other products operating on the same frequency ranges, such as medical equipment, microwave ovens, and wireless LAN devices.
 - Obstacles such as doors and walls may still impact the sound quality even when the devices are within the effective range.
- Note that your Soundbar cannot be paired with other Bluetooth devices while using the Bluetooth option.
- This wireless device may cause electrical interference during operation.

Disconnecting the Bluetooth device from a Soundbar

You can disconnect a Bluetooth device from the Soundbar. For instructions, see the Bluetooth device's user manual.

- The Soundbar will be disconnected.
- If the Soundbar is disconnected from the Bluetooth device, the multicolour LED indicator on the Soundbar blinks "Red" three times.

Disconnecting the Soundbar from the Bluetooth device

Press the **○ (Multi Function)** button on the top of the Soundbar or the **➡ (Source)** button on the remote control to switch the mode from "Bluetooth".

- Disconnecting takes time because the Bluetooth device must receive a response from the Soundbar. (Disconnection time may differ, depending on the Bluetooth device)

Method 2. Connecting via Wi-Fi (Wireless Network)

To connect a Soundbar to a mobile device via a wireless network (Wi-Fi), the **SmartThings** app is required.

The initial connection

1. Install and launch the **SmartThings** app from your mobile device (smartphone or tablet).
2. On the app, follow the screen instructions to add the Soundbar.
 - The automatic pop-up (the second screenshot below) may not show on some devices.
If the pop-up window does not appear, press “+” on the **Home** screen. The Soundbar is added to the app.
 - The illustration below may differ with the app version.

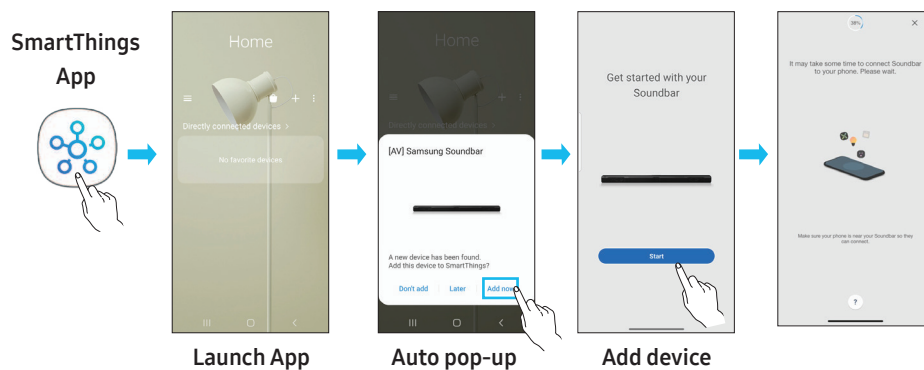

Using the Tap Sound

Tap the Soundbar with your mobile device to play the sound of content on the mobile device through the Soundbar.

- This function may not be supported, depending on the mobile device.
- This function is only compatible with Samsung mobile devices with Android 8.1 or later.

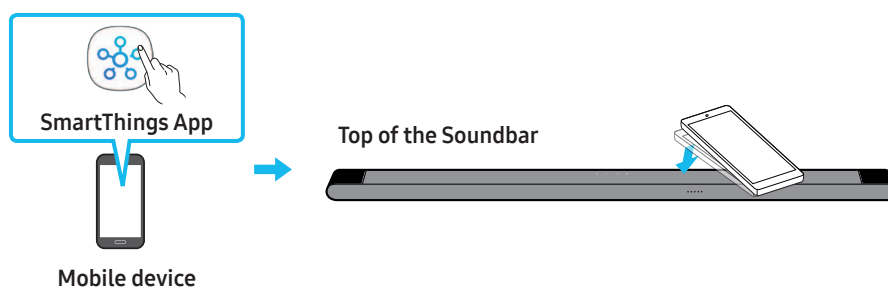

1. Turn on the **Tap Sound** function on your mobile device.
 - For details on how to turn on the function, refer to “**Setting the Tap Sound function**” below.
2. Tap the Soundbar with the mobile device. Select “**Start now**” in the displayed message window. A connection is established between the mobile device and Soundbar via Bluetooth.
3. Play the sound of content on the mobile device through the Soundbar.
 - This function connects a mobile device to the Soundbar via Bluetooth by detecting vibration that occurs when the device touches the Soundbar.
 - Make sure the mobile device does not tap a sharp corner of the Soundbar. The Soundbar or mobile device may become scratched or damaged.
 - It is recommended that the mobile device be covered with a case. Lightly tap the wide area in the upper portion of the Soundbar, without using excessive force.
 - To use this function, update the **SmartThings** app to the latest version. The function may not be supported, depending on the app version.

Setting the Tap Sound function

Use the **SmartThings** app to turn on the **Tap View, Tap Sound** function.

1. On the mobile device, run the **SmartThings** app.
2. Select (☰ → ⚙) in the **SmartThings** app screen displayed on the mobile device.
3. Set “**Tap View, Tap Sound**” to On to allow the function to work when a mobile device moves close to the Soundbar. The function is turned on.

NOTE

- When the mobile device is in power-saving mode, the **Tap Sound** function does not work.
- The **Tap Sound** function may not work if there are devices near the Soundbar that cause radio interference such as electric devices. Make sure devices that may cause radio interference are placed at a sufficient distance away from the Soundbar.

07 CONNECTING VIA APPLE AIRPLAY 2

- This feature may not be available in some countries.
- This Samsung Soundbar supports AirPlay 2 and requires iOS 11.4 or later.

With AirPlay 2, you can stream music, podcasts, and other audio from your Apple devices to the Samsung Soundbar.

- Make sure the Soundbar is powered on and connected to the same Wi-Fi network as your Apple device.
- Select  from an AirPlay-supported app or Control Centre on your iPhone, iPad, or Mac.
- Select the Soundbar from the list of available devices to play the current audio to.

08 INSTALLING THE WALL MOUNT

Installation Precautions

- Install on a vertical wall only.
- Do not install in a place with high temperature or humidity.
- Verify whether the wall is strong enough to support the product's weight. If not, reinforce the wall or choose another installation point.
- Connect cables from the unit to external devices before you install the Soundbar on the wall.
- Make sure the unit is turned off and unplugged before you install it. Otherwise, it may cause an electric shock.

Wallmount Components

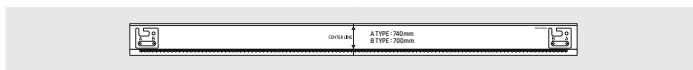

Wall Mount Guide

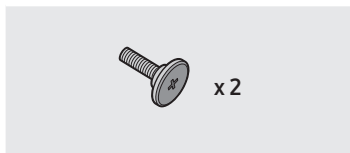

Holder-Screw x 2



Screw x 4

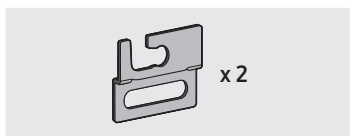

Bracket-Wall Mount x 2



Screw Anchor x 4

1. Place the **Wall Mount Guide** against the wall surface.
 - The **Wall Mount Guide** must be level.
 - If your TV is mounted on the wall, install the Soundbar at least 5 cm below the TV.

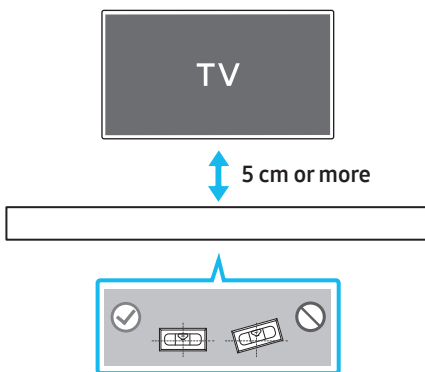

2. Align the **Wall Mount Guide's Centre Line** with the centre of your TV (if you are mounting the Soundbar below your TV), and then fix the **Wall Mount Guide** to the wall using tape.
 - If you are not mounting below a TV, place the **Centre Line** in the centre of the installation area.

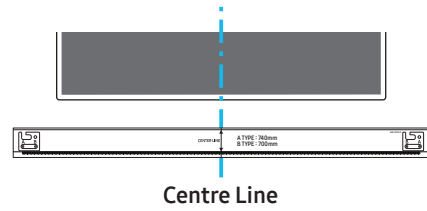

3. Push a pen tip or sharpened pencil tip through the centre of the **A-TYPE** and **B-TYPE** images on each end of the Guide to mark the holes for the supporting screws, and then remove the **Wall Mount Guide**.

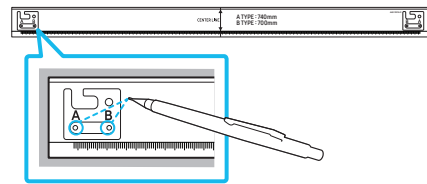

4. Using an appropriately sized drill bit, drill a hole in the wall at each marking.
 - If the markings do not correspond to the positions of studs, make sure you insert appropriate anchors or mollies into the holes before you insert the support screws. If you use anchors or mollies, make sure the holes you drill are large enough for the anchors or mollies you use.
5. Push a screw (not supplied) through each **Screw**, and then screw each screw firmly into a support screw hole.

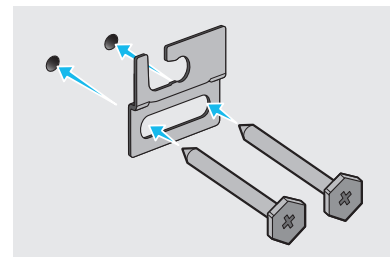

- Install the 2 **Bracket-Wall Mounts** in the correct orientation on the rear of the Soundbar using 2 **Holder-Screws**.

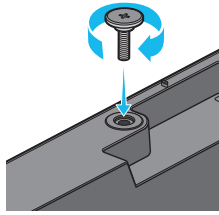

- When assembling, make sure the hanger part of the **Bracket-Wall Mounts** are located behind the rear of the Soundbar.

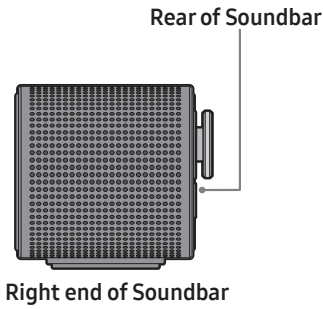

- Install the Soundbar with the attached **Bracket-Wall Mounts** by hanging the **Bracket-Wall Mounts** on the **Holder-Screws** on the wall.

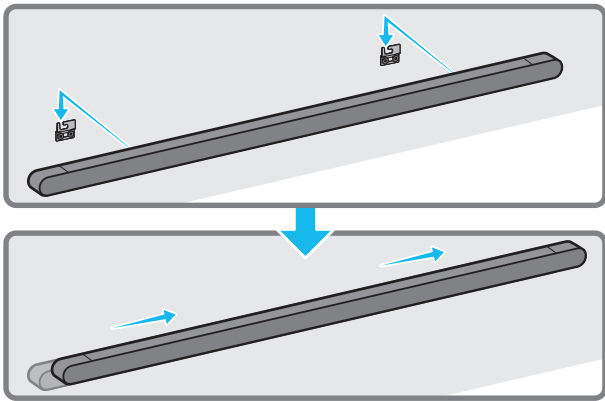

- Slide the Soundbar down as shown below so that the **Bracket-Wall Mounts** rest securely on the **Holder-Screws**.

- Insert the **Holder-Screws** into the wide (rear) part of the **Bracket-Wall Mounts**, and then slide the **Bracket-Wall Mounts** down so that the **Bracket-Wall Mounts** rest securely on the **Holder-Screws**.

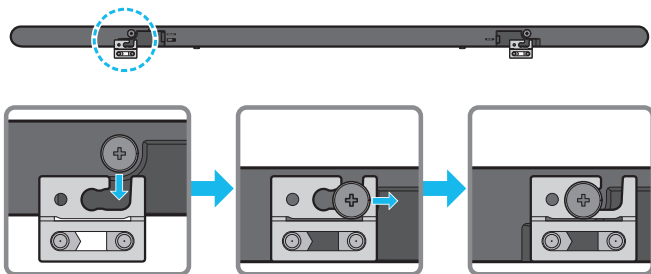

09 INSTALLING THE SOUNDBAR IN FRONT OF TV

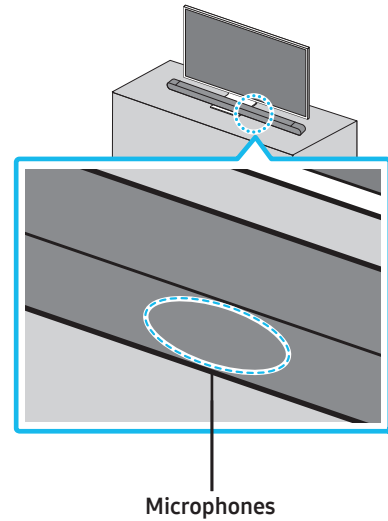

As illustrated in the image, align the centre of the Soundbar with the centre of the TV, carefully place the Soundbar onto the TV stand. At this time, place the microphones at the front of the stand not to interfere with voice recognition.

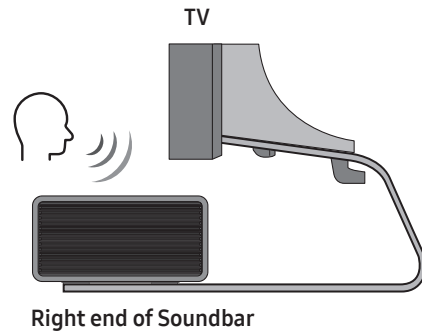

NOTE

- Make sure the Soundbar is placed on a flat and solid surface.
- Insufficient gap from the TV may cause voice recognition and acoustic problems.
- The illustration above differs with the respective model.

10 SOFTWARE UPDATE

Auto Update

When the Soundbar is connected to the Internet, software updates automatically occur even when the Soundbar is turned off.

- To use the Auto Update function, the Soundbar must be connected to the Internet.

The Wi-Fi connection to the Soundbar will be terminated if the Soundbar's power cord is disconnected or the power is cut off. If the power is cut off, when the power comes back on or you reconnect the power cord, turn on the Soundbar, and then reconnect it to the Internet.

USB Update

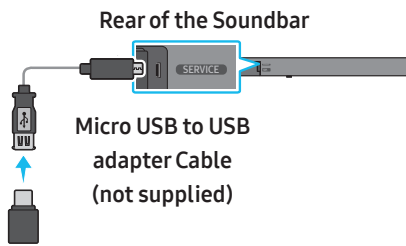

Samsung may offer updates for the Soundbar's system firmware in the future.

When an update is available, you can update the Soundbar by connecting the USB drive that contains the update firmware to the **SERVICE** port of the Soundbar.

- Go to (www.samsung.com) → search for the model name from the customer support menu option.
 - For more information about update, refer to Upgrade Guide.
- Download the upgrade file (USB type).
- Unzip the file to create a folder with the file name.
- Store the created folder in a USB and then connect it to the Soundbar.
- Turn on the Soundbar. Then the product is updated within 3 minutes.

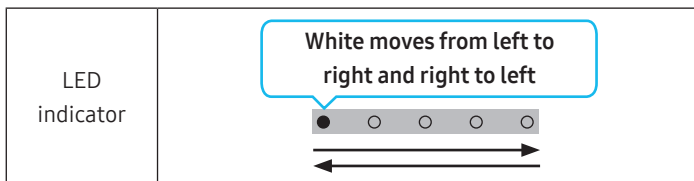

- During update, do not turn it off or remove the USB.
- If the yellow LED is on after the software update is completed, this means that an additional update is in progress. When this happens, don't turn off the power or remove the USB.
- If update does not proceed, reconnect the Soundbar power cord.
- When the latest version is installed, no update is performed.
- Depending on the USB type, update may not be supported.

- If there is no update file available, the indicator blinks red 3 times.

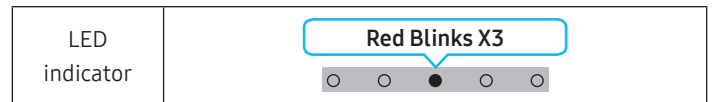

- If the update file is in the same or lower version than the existing, the indicator blinks cyan 3 times.

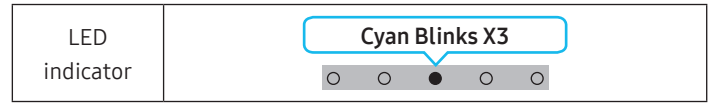

Reset

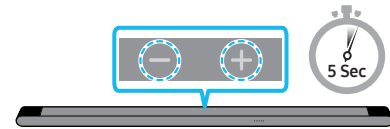

With the Soundbar on, press the **— + (Volume)** buttons on the body at the same time for at least 5 seconds. The LED display changes as shown below and then the Soundbar is reset.

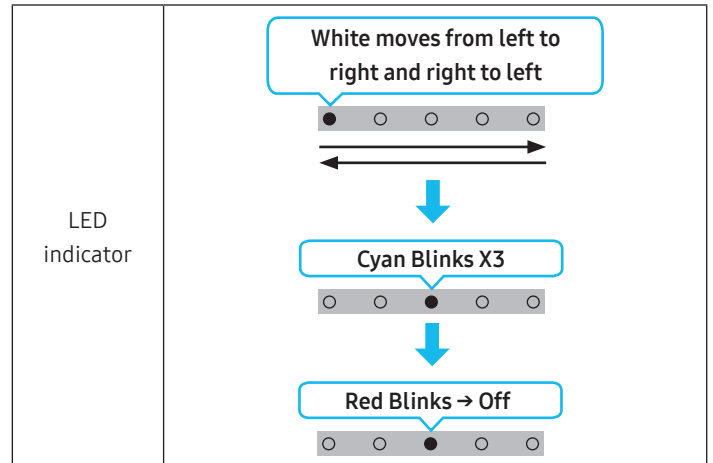

⚠ CAUTION

- All the settings of the Soundbar are reset. Be sure to perform this only when a reset is required.

11 TROUBLESHOOTING

Before seeking assistance, check the following.

Soundbar does not turn on.

- Check whether the power cord of the Soundbar is correctly inserted into the outlet.

Soundbar works erratically.

- After removing the power cord, insert it again.
- Power cycle the external device and try again.
- If there is no signal, the Soundbar automatically turns off after a certain period of time. Turn on the power. (See page 9.)

Remote control does not work

- Point the remote directly at the soundbar.
- Recharge the remote control.

The Soundbar indicator turns solid red.

- The microphone is turned off.
Turn on the microphone. (See page 7.)

Sound is not output from the soundbar.

- The volume of the Soundbar is too low or muted. Adjust the volume.
- When any external device (STB, Bluetooth device, mobile device, etc.) is connected, adjust the volume of the external device.
- For sound output of the TV, select Soundbar. (Samsung TV: Home (🏠) → Menu → Settings (⚙️) → All Settings (⚙️) → Sound → Sound Output → Select Soundbar)
- The cable connection to the Soundbar may not be loose. Remove the cable and connect again.
- Remove the power cord completely, reconnect, and turn the power on.
- Reset the product and try again. (See page 30.)

Sound is not output from the subwoofer.

- Check whether the LED indicator on the rear of the Subwoofer is on in blue. Reconnect the Soundbar and Subwoofer if the indicator is blinking in blue or turned red. (See page 15.)
- You may experience an issue if there is an obstacle between the Soundbar and Subwoofer. Move devices to an area away from obstacles.
- Other devices sending radio frequency signals in proximity may interrupt the connection.
Keep your speaker away from such devices.
- Remove and reconnect the power plug.

In case there is sound jitter, delays, or noise from the Subwoofer

- If there are any objects between the Soundbar and Subwoofer, this could cause a problem. Please reposition these to a place without such an object.
- There may be sound jitter or delays when the Subwoofer is far from the Soundbar. Please place them near the Soundbar.
- There may be sound jitter or delays when the Soundbar is near an instrument or electrical device that can cause radio interference. Place the Soundbar far from such devices that can cause radio interference. (E.g., wireless router)
- Change the TV network connection status from wireless to wired.

The Subwoofer volume is too low

- The original volume of the content you are playing may be low. Try adjusting the Subwoofer level. (See page 10.)
- Bring the Subwoofer speaker closer to you.

If the TV is not connected via HDMI (ARC).

- Check whether the HDMI cable is correctly connected to the ARC terminal. (See page 17.)
- Connection may not be possible due to the connected external device (set-top box, game console, etc.). Directly connect the Soundbar.
- HDMI-CEC may not be activated on the TV. Turn on the CEC on the TV menu. (Samsung TV: Home (🏠) → Menu → Settings (⚙️) → All Settings (⚙️) → Connection → External Device Manager → Anynet+ (HDMI-CEC) ON)

There is no sound in when connecting to the TV in HDMI (ARC) mode

- Your device is unable to play the input signal. Change the TV's audio output to PCM or Dolby Digital. (For a Samsung TV: Home (🏠) → Menu → Settings (⚙️) → All Settings (⚙️) → Sound → Expert Settings → Digital Output Audio Format)

Soundbar will not connect via Bluetooth.

- When connecting a new device, switch to "Bluetooth Pairing" for connection. (Press the **PAIR** button on the remote control or press the **⊘ (Mic On/Off)** button on the body for at least 5 seconds.)
- If the Soundbar is connected to another device, disconnect that device first to switch the device.
- Reconnect it after removing the Bluetooth speaker list on the device to connect. (Samsung TV: Home (🏠) → Menu → Settings (⚙️) → All Settings (⚙️) → Sound → Sound Output → Bluetooth Speaker List)
- Remove and reconnect the power plug, then try again.
- Reset the product and try again. (For more information, refer to "Reset".)

Sound drops out when connected via Bluetooth.

- Some devices can cause radio interference if they are located too close to the Soundbar. e. g. microwaves, wireless routers, etc.
- If your device that is connected via Bluetooth moves too far away from the soundbar, it may cause the sound to drop out. Move the device closer to the soundbar.
- If a part of your body is in contact with the Bluetooth transceiver or the product is installed on metal furniture, the sound may drop out. Check the installation environment and conditions for use.

Soundbar will not connect to Wi-Fi.

- Check whether your wireless router is on.
- Turn off the router, turn it back on, and then try again.
- The soundbar will not connect if the wireless signal is too weak. Try moving the router closer to the soundbar, or eliminating any obstacles that are between the soundbar and the router, if possible.
- If your wireless router is new, you will need to reconfigure the speaker's network settings.

The soundbar does not turn on automatically with the TV.

- When you turn off the Soundbar while watching TV, power synchronization with the TV is disabled. First turn off the TV.

The AVA function is not available in the following cases.

- The AVA function will not be available using Q-symphony function.
- The AVA function will not be available when the microphone is turned off.

After connecting the TV to the Soundbar, I switched the Soundbar mode. Then no sound is output from the TV.

- If you connect your Soundbar to a mobile device while the Soundbar is connected to the TV, the Soundbar outputs sound from the mobile device while keeping the TV connection. So the TV sound will not be delivered anywhere.
- Disconnect the mobile device, and the TV sound will be output from the Soundbar again.

12 LICENCE



Dolby, Dolby Atmos, and the double-D symbol are registered trademarks of Dolby Laboratories Licensing Corporation. Manufactured under license from Dolby Laboratories. Confidential unpublished works. Copyright © 2012-2021 Dolby Laboratories. All rights reserved.



For DTS patents, see <http://patents.dts.com>. Manufactured under license from DTS, Inc. (for companies headquartered in the U.S./ Japan/ Taiwan) or under license from DTS Licensing Limited (for all other companies). DTS, Digital Surround, Virtual:X, and the DTS logo are registered trademarks or trademarks of DTS, Inc. in the United States and other countries. © 2021 DTS, Inc. ALL RIGHTS RESERVED.



The terms HDMI and HDMI High-Definition Multimedia Interface, and the HDMI Logo are trademarks or registered trademarks of HDMI Licensing Administrator, Inc. in the United States and other countries.



- Use your phone, tablet or computer as a remote control for Spotify. Go to spotify.com/connect to learn how
- The Spotify Software is subject to third party licenses found here: <https://www.spotify.com/connect/third-party-licenses>.



- Apple, Airplay, iPhone, iPad, and Mac are trademarks of Apple Inc., registered in the U.S. and other countries.
- Use of the Works with Apple badge means that an accessory has been designed to work specifically with the technology identified in the badge and has been certified by the developer to meet Apple performance standards.



[ENERGY STAR]

ENERGY STAR qualified model only

- Your Samsung product is ENERGY STAR qualified in its factory default setting. Change to certain features, settings and functionality in this product can change the power consumption, possibly beyond the limits required for ENERGY STAR qualification.
- Environmental Protection Agency and Department of Energy. ENERGY STAR is a joint program of the Government agencies, designed to promote energy efficient products and practices.

Refer to www.energystar.gov for more information of the ENERGY STAR Program.

ENERGY STAR qualified model only

(Applicable to Thin Client models only)

As an ENERGY STAR® Partner, SAMSUNG has determined that this product meets the ENERGY STAR® guidelines for energy efficiency.

- The ENERGY STAR Program has been to reduced greenhouse gas emissions and save energy through voluntary labeling.
- Power management setting of this product have been enabled by default, and have various timing setting from 1 minutes to 5 hours.
- The product can wake with a button press on the chassis from sleep mode.

ENERGY STAR qualified model only (The other models)

- As an ENERGY STAR Partner, Samsung has determined that this product or product models meets the ENERGY STAR guideline for energy efficiency.
-

13 OPEN SOURCE LICENCE NOTICE

To send inquiries and requests for questions regarding open sources, contact Samsung Open Source (<http://opensource.samsung.com>)

14 IMPORTANT NOTES ABOUT SERVICE

- Figures and illustrations in this User Manual are provided for reference only and may differ from actual product appearance.
- An administration fee may be charged if either
 - (a) an engineer is called out at your request and there is no defect with the product (i.e. where the user manual has not been read).
 - (b) you bring the unit to a repair centre and there is no defect with the product (i.e. where the user manual has not been read).
- You will be informed of the administration fee amount before a technician visits.

15 SPECIFICATIONS AND GUIDE

Specifications

Model Name	HW-S800B / HW-S801B
Weight	1.4 kg
Dimensions (W x H x D)	1160.0 x 38.0 x 39.9 mm
Operating Temperature Range	+5°C to +35°C
Operating Humidity Range	10 % ~ 75 %
AMPLIFIER Rated Output power	(20W x 2) + (10W x 2) + (20W x 2) + (10W x 1) + (10W x 2)
Supported play formats	Dolby 5.1ch / Dolby Digital Plus / Dolby ATMOS (Dolby Digital Plus) / DTS 5.1ch / LPCM 2ch
WIRELESS DEVICE OUTPUT POWER Wi-Fi max transmitter power	100mW at 2.4GHz – 2.4835GHz, 200mW at 5.15GHz – 5.25GHz, 100mW at 5.25GHz – 5.35GHz & 5.47GHz – 5.725GHz
WIRELESS DEVICE OUTPUT POWER BT max transmitter power	100mW at 2.4GHz – 2.4835GHz
WIRELESS DEVICE OUTPUT POWER SRD max transmitter power	25mW at 5.775GHz – 5.875GHz

Subwoofer Name	HW-S800B : PS-WB85D HW-S801B : PS-WB86D
Weight	6.4 kg
Dimensions (W x H x D)	238.0 x 240.8 x 238.0 mm
AMPLIFIER Rated Output power	200 W
WIRELESS DEVICE OUTPUT POWER SRD max transmitter power	25mW at 5.775GHz – 5.875GHz

NOTE

- Samsung Electronics Co., Ltd reserves the right to change the specifications without notice.
- Weight and dimensions are approximate.

Precaution : The Soundbar will restart automatically if you turn on/turn off Wi-Fi.

Overall Standby Power Consumption (W)	5.1 W
To deactivate Wi-Fi connection:	Press and hold the CH LEVEL button on the remote control of the Soundbar for more than 30 seconds to turn on or off the Wi-Fi connection.
To deactivate Bluetooth connection:	Press and hold the TONE CONTROL button on the remote control of the Soundbar for more than 30 seconds to turn on or off the Bluetooth connection.

- Hereby, Samsung declares that this radio equipment is in compliance with Directive 2014/53/EU and the relevant UK statutory requirements. The full text of the declaration of conformity is available at the following internet address:
<http://www.samsung.com> go to Support and enter the model name.
This equipment may be operated in all EU countries and in the UK.
The 5GHz WLAN(Wi-Fi or SRD) function of this equipment may only be operated indoors.



[Correct disposal of batteries in this product]

(Applicable in countries with separate collection systems)

The marking on the battery, manual or packaging indicates that the battery in this product should not be disposed of with other household waste. Where marked, the chemical symbols Hg, Cd or Pb indicate that the battery contains mercury, cadmium or lead above the reference levels in EC Directive 2006/66.

The battery incorporated in this product is not user replaceable. For information on its replacement, please contact your service provider. Do not attempt to remove the battery or dispose it in a fire. Do not disassemble, crush, or puncture the battery. If you intend to discard the product, the waste collection site will take the appropriate measures for the recycling and treatment of the product, including the battery.

Removing the battery

- To remove the battery, contact an authorised service centre.
To obtain battery removal instructions, please visit www.samsung.com/global/ecodesign_energy.
- For your safety, you must not attempt to remove the battery.
If the battery is not properly removed, it may lead to damage to the battery and device, cause personal injury, and/or result in the device being unsafe.



**Correct Disposal of This Product
(Waste Electrical & Electronic Equipment)**

(Applicable in countries with separate collection systems)

This marking on the product, accessories or literature indicates that the product and its electronic accessories (e.g. charger, headset, USB cable) should not be disposed of with other household waste at the end of their working life. To prevent possible harm to the environment or human health from uncontrolled waste disposal, please separate these items from other types of waste and recycle them responsibly to promote the sustainable reuse of material resources.

Household users should contact either the retailer where they purchased this product, or their local government office, for details of where and how they can take these items for environmentally safe recycling.

Business users should contact their supplier and check the terms and conditions of the purchase contract. This product and its electronic accessories should not be mixed with other commercial wastes for disposal.

For information on Samsung’s environmental commitments and product specific regulatory obligations e.g. REACH, WEEE, Batteries, visit:
www.samsung.com/uk/aboutsamsung/sustainability/environment/our-commitment/data/

COMMISSION REGULATION (EU) 2019/1782

Ecodesign requirements for external power supplies :
www.samsung.com/global/ecodesign_component





UNITED KINGDOM



EIRE

This Samsung product is warranted for the period of twelve (12) months from the original date of purchase, against defective materials and workmanship. In the event that warranty service is required, you should return the product to the retailer from whom it was purchased. However, Samsung Authorised Dealers and Authorised Service Centres in other EC Countries will comply with the warranty on the terms issued to purchasers in the country concerned. In case of difficulty, details of our Authorised Service Centres are available from:

Samsung Electronics U.K. Ltd
Samsung Customer Support Centre
Selectapost 38, Sheffield, S97 3FJ
United Kingdom

United Kingdom
Tel : 0333 000 0333
www.samsung.com/uk/support

EIRE
Tel : 0818 717100
www.samsung.com/ie/support

■ WARRANTY CONDITIONS

1. The warranty is only valid if, when warranty service is required, the warranty card is fully and properly completed and is presented with the original invoice or sales slip or confirmation, and the serial number on the product has not been defaced.
2. Samsung's obligations are limited to the repair or, at its discretion, replacement of the product or the defective part. Repaired or replaced products may include new and or refurbished components and equipment.
3. Warranty repairs must be carried out by Authorised Samsung Dealers or Authorised Service Centres. No re-imburement will be made for repairs carried out by non Samsung Dealers and, any such repair work and damage to the products caused by such repair work will not be covered by this warranty.
4. This product is not considered to be defective in materials nor workmanship by reason that it requires adaptation in order to conform to national or local technical or safety standards in force in any Country other than the one for which the product was originally designed and manufactured. This warranty will not cover, and no re-imburement will be made for such adaptation nor any damage which may result.
5. This warranty covers none of the following:
 - a) Periodic check ups, maintenance and repair or replacement of parts due to normal wear and tear.
 - b) Cost relating to transport, removal or installation of the product.
 - c) Misuse, including the failure to use this product for its normal purposes or incorrect installation.
 - d) Damage caused by Lightning, Water, Fire, Acts of God, War, Public Disturbances, incorrect mains voltage, improper ventilation or any other cause beyond the control of Samsung.
6. This warranty is valid for any person who legally acquired possession of the product during the warranty period.
7. The consumers' statutory rights in any applicable national legislation whether against the retailer arising from the purchase contract or otherwise are not affected by this warranty. Unless there is national legislation to the contrary, the rights under this warranty are the consumers' sole rights and Samsung, its subsidiaries and distributors shall not be liable for indirect or consequential loss or any damage to disc based media, removable memory or any other related equipment or material.
8. Samsung shall honour warranties for all EU specification products purchased by a consumer within the following European countries listed.
 - UK, Republic of Ireland, Germany, France, Italy, Malta, Spain, Portugal, The Netherlands, Belgium, Luxembourg, Denmark, Sweden, Finland, Poland, Hungary, Czech Republic, Slovakia, Austria, Slovenia, Croatia, Estonia, Latvia, Lithuania, Greece, Cyprus, Romania, Bulgaria, Switzerland, Norway, Lichtenstein and Iceland.

© 2022 Samsung Electronics Co., Ltd. All rights reserved.

Contact SAMSUNG WORLD WIDE

If you have any questions or comments relating to Samsung products, please contact the SAMSUNG customer care Centre.

Country	Samsung Service Centre ☎	Web Site
UK	0333 000 0333	www.samsung.com/uk/support
IRELAND (EIRE)	0818 717100	www.samsung.com/ie/support
GERMANY	06196 77 555 77	www.samsung.com/de/support
FRANCE	01 48 63 00 00	www.samsung.com/fr/support
ITALIA	800-SAMSUNG (800.7267864)	www.samsung.com/it/support
SPAIN	91 175 00 15	www.samsung.com/es/support
PORTUGAL	210 608 098 Chamada para a rede fixa nacional Dias úteis das 9h às 20h	www.samsung.com/pt/support
LUXEMBURG	261 03 710	www.samsung.com/be_fr/support
NETHERLANDS	088 90 90 100	www.samsung.com/nl/support
BELGIUM	02-201-24-18	www.samsung.com/be/support (Dutch) www.samsung.com/be_fr/support (French)
NORWAY	21629099	www.samsung.com/no/support
DENMARK	707 019 70	www.samsung.com/dk/support
FINLAND	030-6227 515	www.samsung.com/fi/support
SWEDEN	0771-400 300	www.samsung.com/se/support
POLAND	801-172-678* lub +48 22 607-93-33* * (opłata według taryfy operatora)	http://www.samsung.com/pl/support/
HUNGARY	0680SAMSUNG (0680-726-7864)	www.samsung.com/hu/support
AUSTRIA	0800 72 67 864 (0800-SAMSUNG)	www.samsung.com/at/support
SWITZERLAND	0800 726 786	www.samsung.com/ch/support (German) www.samsung.com/ch_fr/support (French)
CZECH	800 - SAMSUNG (800-726786)	www.samsung.com/cz/support
SLOVAKIA	0800 - SAMSUNG (0800-726 786)	www.samsung.com/sk/support
CROATIA	072 726 786	www.samsung.com/hr/support
BOSNIA	055 233 999	www.samsung.com/ba/support
North Macedonia	023 207 777	www.samsung.com/mk/support
MONTENEGRO	020 405 888	www.samsung.com/support
SLOVENIA	080 697 267 (brezplačna številka)	www.samsung.com/si/support
SERBIA	011 321 6899	www.samsung.com/rs/support
Kosovo	038 40 30 90	www.samsung.com/support
ALBANIA	045 620 202	www.samsung.com/al/support
BULGARIA	0800 111 31 - Безплатен за всички оператори *3000 - Цена на един градски разговор или според тарифата на мобилният оператор 09:00 до 18:00 - Понеделник до Петък	www.samsung.com/bg/support
ROMANIA	0800872678 - Apel gratuit *8000 - Apel tarifat în rețea	www.samsung.com/ro/support
CYPRUS	8009 4000 only from landline, toll free	www.samsung.com/gr/support
GREECE	80111-SAMSUNG (80111 726 7864) only from land line (+30) 210 6897691 from mobile and land line	
LITHUANIA	8-800-77777	www.samsung.com/lt/support
LATVIA	8000-7267	www.samsung.com/lv/support
ESTONIA	800-7267	www.samsung.com/ee/support