

Contents

1	Instructions	34
1.1	General safety instructions	34
1.2	Appliance purpose	38
1.6	Disposal	39
1.7	How to read the user manual	40
2	Description	41
2.1	General Description	41
2.2	Control panel	42
3	Use	43
3.1	Instructions	43
3.2	Preliminary operations	44
3.3	Using the hob	44
3.4	Special functions	50
3.5	Timer functions	51
3.6	Error codes	53
4	Cleaning and maintenance	54
4.1	Instructions	54
4.2	Cleaning the surfaces	54
4.3	Ordinary weekly cleaning	54
4.4	Food stains or residues	54
4.5	What to do if...	55
5	Installation	56
5.1	Electrical connection	56
5.2	Instructions for the installer	57
5.3	Power limitation procedure (for installer only)	57
5.4	Safety instructions	58
5.5	Section cut from the countertop	59
5.6	Mounting	60

TRANSLATION OF THE ORIGINAL INSTRUCTIONS

We advise you to read this manual carefully, which contains all the instructions for maintaining the appliance's aesthetic and functional qualities.

For further information on the product: www.smeg.com



1 Instructions

1.1 General safety instructions

Risk of personal injury

- During use the appliance and its accessible parts become very hot.
- Never touch the heating elements during use.
- Never try to put out a fire or flames with water: Turn off the appliance and smother the flames with a fire blanket or other appropriate cover.
- This appliance may be used by children aged at least 8 and by people of reduced physical, sensory or mental capacity, or lacking in experience in the use of electrical appliances, provided that they are supervised or instructed by adults who are responsible for their safety.
- Children must not play with the appliance.
- Keep children under the age of eight at a safe distance unless they are constantly supervised.
- Keep children under the age of 8 away from the appliance when it is in use.
- Cleaning and maintenance must not be carried out by unsupervised children.
- Be aware of how rapidly the cooking zones heat up. Do not let pans heat up when dry, as there is a danger of them overheating.
- Fats and oils can catch fire if they overheat. Do not leave the appliance unattended while preparing foods containing oils or fats. If fats or oils catch fire, never put water on them. Place the lid on the pan and turn off the relevant cooking zone.
- Do not use the Booster and Double Booster functions to heat fats or oils. Fire hazard.
- The cooking process must always be monitored. A short cooking process must be continuously monitored.
- Do not place metal objects, such as dishes or cutlery, on the hob surface during use as they may overheat.
- Do not insert pointed metal objects (cutlery or utensils) into the slots in the appliance.



- Do not use or store flammable materials near the appliance or directly underneath the hob.
- **DO NOT USE AEROSOLS IN THE VICINITY OF THIS APPLIANCE WHILST IT IS IN USE.**
- Switch off the appliance immediately after use.
- **DO NOT MODIFY THIS APPLIANCE.**
- Always use any necessary/required personal protective equipment (PPE) before performing any work on the appliance (installation, maintenance, positioning or movement).
- Before performing any work on the appliance, switch off the power supply.
- Installation and servicing should be carried out by qualified personnel in accordance with current standards.
- Do not try to repair the appliance yourself or without the assistance of a qualified technician.
- If the power supply cable is damaged, contact technical support immediately and they will replace it.

Risk of damaging the appliance

- Do not use abrasive or corrosive detergents (e.g. scouring powders, stain removers and metallic sponges) on glass parts.
- Do not place hot pans on the control panel.
- Use wooden or plastic utensils.
- Do not sit on the appliance.
- Do not use the hob as a support surface.
- Do not obstruct ventilation openings and heat dispersal slots.
- Do not use steam jets to clean the appliance.
- Never leave the appliance unattended during cooking operations where fats or oils could be released, as these could then heat up and catch fire. Be very careful.
- Fire hazard: Never leave objects on the cooking surfaces.
- **DO NOT FOR ANY REASON USE THE APPLIANCE AS A SPACE HEATER.**
- Cooking vessels or griddle plates should be placed inside the perimeter of the hob.



Instructions

- All pans must have smooth, flat bottoms.
- If any liquid does boil over or spill, remove the excess from the hob.
- Take care not to spill acid substances such as lemon juice or vinegar on the hob.
- Do not spill sugar or sweet mixtures on the hob during cooking.
- Do not place materials or substances that could melt or catch fire (paper, plastic or aluminium foil) on the appliance while it is in use.
- Place the cookware directly on the glass ceramic surface.
- Do not put empty pans or frying pans on switched on cooking zones.
- Do not use rough or abrasive materials or sharp metal scrapers.
- Do not use cleaning products containing chlorine, ammonia or bleach on parts made of steel or that have metallic surface finishes (e.g. anodizing, nickel- or chromium-plating).

Installation

- THIS APPLIANCE **MUST NOT BE INSTALLED** IN BOATS OR CARAVANS.
- Position the appliance into the cabinet cut-out with the help of a second person.
- Check that the carcass material is heat resistant.
- Check that the carcass has the required openings.
- To avoid potential overheating, the appliance must not be installed behind a decorative door or a panel.
- Have the electrical connection performed by authorised technical personnel.
- The appliance must be connected to earth in compliance with electrical system safety standards.
- Use cables withstanding a temperature of at least 90°C.
- The tightening torque of the screws of the terminal supply wires must be 1.5 - 2 Nm.
- The power cable must only be installed or replaced by a qualified technician.



For this appliance

- If cracks or fissures form, or if the glass ceramic cooking surface breaks, turn off the appliance immediately. Disconnect the power supply and call Technical Support.
- Avoid hard, solid objects falling on the cooking surface.
- Do not use the hob if the pyrolytic cycle is taking place inside any oven installed below.
- Do not touch or clean the hob surface during operation or when the residual heat indicator lights are still on.
- Activate the controls lock when you have children or pets which could reach the hob.
- After use the cooking zones remain hot for a certain period of time after they have been turned off. Do not touch the hob surfaces.
- After use, switch off the plates. Never rely solely on the cookware detector.
- Supervise children carefully as they cannot readily see the residual heat indication. After use the cooking zones remain hot for a certain period of time even if they have been turned off. Keep children away from the cooking zones.
- The glass ceramic surface is highly resistant to impact. However, prevent hard, solid objects from falling on the cooking surface as they may cause it to break if they are sharp.
- Do not use the glass ceramic cooking surface as a support surface.
- Remove any traces of liquid from the cover (if fitted) before opening.
- Let the cooking surface cool down before closing the cover.
- People who have pacemakers or other similar devices fitted must make sure that the operation of these devices is not affected by the induction field, the frequency range of which is between 20 and 50 kHz.



Instructions

- In conformity with the provisions regarding electromagnetic compatibility, the electromagnetic induction cooking hob comes under group 2 and class B (EN 55011).
- This appliance complies with the current standards and directives regarding safety and electromagnetic compatibility. However, people who wear pacemakers should keep a minimum distance of 20-30 cm between the pacemaker and the appliance when it is in operation. Contact the pacemaker manufacturer for further information.

1.2 Appliance purpose

- This appliance is intended for cooking food in the home environment. Every other use is considered improper.
- The appliance is not designed to operate with external timers or with remote-control systems.

1.3 Manufacturer's liability

- The manufacturer declines all liability for damage to persons or property caused by:
- Use of the appliance other than that specified
- Failure to comply with the instructions in the user manual
- Tampering with any part of the appliance
- The use of non-original spare parts.

1.4 Identification plate

The identification plate bears the technical data, serial number and brand name of the appliance. Do not remove the identification plate for any reason.

1.5 This user manual

This user manual is an integral part of the appliance and must therefore be kept in its entirety and within the user's reach for the whole working life of the appliance.

- Read this user manual carefully before using the appliance.



1.6 Disposal



This appliance conforms to the WEEE European directive (2012/19/EU) and must be disposed of separately from other waste at the end of its service life.

The appliance does not contain substances in quantities sufficient to be considered hazardous to health and the environment, in accordance with current European directives.

To dispose of the appliance:

- Cut the power supply cable and remove it along with the plug.



Power voltage

Danger of electrocution

- Disconnect the mains power supply.
- Unplug the appliance.

- Deliver the appliance to the appropriate recycling centre for electrical and electronic equipment waste, or return it to the retailer when purchasing an equivalent product, on a one for one basis.

Our appliances are packaged in non-polluting and recyclable materials.

- Deliver the packing materials to the appropriate recycling centre.



Plastic packaging

Danger of suffocation

- Do not leave the packaging or any part of it unattended.
- Do not let children play with the plastic bags.



Instructions

1.7 How to read the user manual

This user manual uses the following reading conventions:

Instructions



General information on this user manual, on safety and final disposal.

Description



Description of the appliance and its accessories.

Use



Information on the use of the appliance and its accessories, cooking advice.

Cleaning and maintenance



Information for proper cleaning and maintenance of the appliance.

Installation



Information for the qualified technician: Installation, operation and inspection.



Safety instructions



Information



Advice

1. Sequence of instructions for use.

- Standalone instruction.



2 Description

2.1 General Description

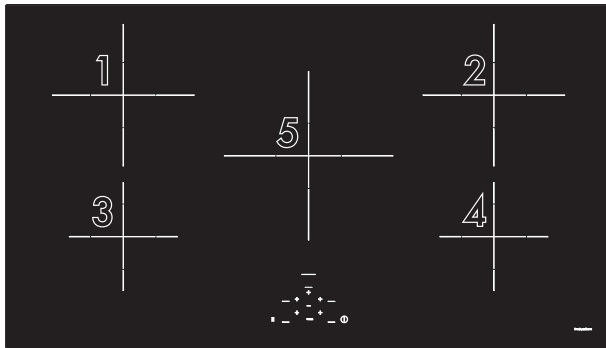

Maximum absorbed power table (Watt)

Zones	Dimensions H x L (mm)	Level 9	Booster	Double Booster
1 - 2	210 x 210	2300	3000	-
3 - 4	160 x 160	1400	1850	2100
5	250 x 250	2300	3000	-

* power levels are approximate and may vary according to the pan used or the settings made.

Advantages of induction cooking



The appliance is equipped with an induction generator for each cooking zone. Each generator located under the glass ceramic cooking surface creates an electromagnetic field which induces a thermal current in the base of the pan. This means the heat is no longer transmitted from the hob to the pan but created directly inside the pan by the inductive current.

- Energy saving thanks to the direct transmission of energy to the pan (suitable magnetisable cookware is required) compared to traditional electric cooking.
- Improved safety as the energy is only transmitted to the pan placed on the hob.
- High level of energy transmitted from the induction cooking zone to the base of the pan.
- Rapid heating speed. Reduced danger of burns as the cooking surface is only heated under the base of the pan; food that overflows does not stick.



Description

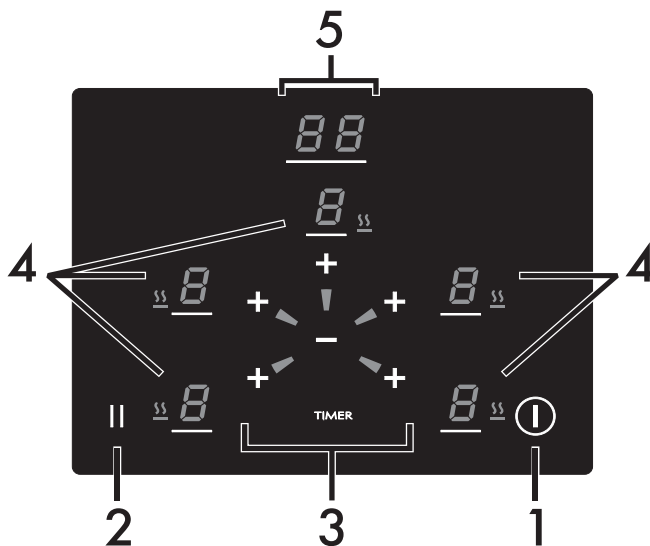

2.2 Control panel



1 On/Off button

2 Pause button.

3 Cooking zone and timer setting area

i This area has 5 radial LEDs that branch out from the  button to the  buttons, which light up to indicate that the corresponding cooking zone has been activated.

4 Cooking zone display

5 Timer display

Power control

The hob is fitted with a power control module that optimises/limits consumption. If the overall set power level exceeds the maximum limit permitted, the electronic circuit board will automatically manage the power supplied by the hot plates. The module tries to maintain the maximum deliverable power levels. Levels set by the automatic control will appear on the display.



Priority is given to the last zone that was set in chronological order.



The power control module does not affect the total power consumption of the appliance.



3 Use

3.1 Instructions



High temperature Danger of burns

- Protect your hands by wearing heat-proof gloves during use.
- Do not touch or clean the hob surface during operation or when the residual heat indicator lights are still on.
- Do not put empty pans or frying pans on switched on cooking zones.
- Keep children under the age of 8 away from the appliance when it is in use.
- Activate the controls lock when you have children or pets which could reach the hob.
- After use the cooking zones remain hot for a certain period of time after they have been turned off. Do not touch the hob surfaces.



High temperature Danger of fire or explosion

- Do not use or leave flammable materials near the appliance or directly underneath the hob.
- Do not cook in closed tins or containers, plastic kitchenware or containers.
- Do not leave the appliance unattended during cooking operations where fats or oils could be released.
- In case you notice cracks or fissures or you cannot turn off the appliance, disconnect the power supply and contact the Assistance Centre.



Improper use Risk of damage to surfaces

- Do not use the hob if the pyrolytic cycle is taking place inside any oven installed below.
- Never place pans with bases which are not perfectly flat and smooth.
- Avoid hard, solid objects falling on the cooking surface.
- Do not use the hob as a support surface.



Use

3.2 Preliminary operations

In order to remove any moisture that could have accumulated during the manufacturing process and for the electronic circuits and control keypad to work properly:

1. Remove the protective films from the external surfaces of the appliance and accessories.
2. Remove any labels (apart from the technical data plate).

3.3 Using the hob

All the appliance's control and monitoring devices are located together on the front panel. The induction hob is controlled by means of the Touch control sensor buttons. Lightly touch a symbol on the glass ceramic surface. A beep will sound to confirm every effective touch.

Switching on the hob for the first time



On first connection to the electrical mains, an automatic check will be carried out that will switch on all indicator lights for a few seconds.

Press the  button to switch on the hob; a sound will be emitted to confirm that it is switched on. The cooking zone displays

show .

List of symbols



On/Off button: turns the hob on or off.



Pause button: pauses the appliance's functions.



Value increase button



Value decrease button.



Timer activation button.



Warming function icon.

Cooking zone display



Shows the selected power level for each zone.

Timer display



Shows the digits of the independent minute minder timer and the timed cooking timer.

Minimum cookware diameter

Make sure that the minimum diameter of the pans is the same as those indicated in the following table.

Zones	∅ minimum (cm)	∅ recommended (cm)
1 - 2	9 - 11	21
3 - 4	7 - 9	16
5	11 - 13	25



Bear in mind the following:

- Centre the pans with respect to the cross printed on the cooking zones.
- Do not cover the control panel.
- Do not place the pans next to the edges of the glass.
- If you use a griddle, it must be a maximum size of 36 x 25 cm and must only be used horizontally on zone **5**, after preheating for 2/3 minutes at low power.

Cookware suitable for use in induction cooking

Cookware used on the induction cooking surface must be made of metal, with magnetic properties and a sufficiently large base.

Suitable cookware:



- Enamelled steel cookware with thick bases.
- Cast iron cookware with an enamelled base.
- Cookware in multilayer stainless steel, ferritic stainless steel and aluminium with a special base.

Unsuitable cookware:

- Copper, stainless steel, aluminium, fireproof glass, wood, ceramic and terracotta cookware.

To see whether the pan is suitable, bring a magnet close to the bottom: if it is attracted, the pan is suitable for induction cooking.

If you do not have a magnet, you can put a small amount of water in the pan, place it on a cooking zone and start the hot plate.

The  symbol alternating with  means that the pan is not suitable or that there is no pan.

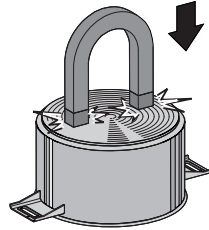

Use only cookware with a perfectly flat bottom which is suitable for induction hot plates. Using cookware with an irregular bottom could jeopardise the efficiency of the heating system and prevent cookware from being detected on the hot plate.



Make sure that the pans do not cover the control panel.



Limiting the cooking duration

The hob has an automatic device which limits the duration of use. If the cooking zone settings are not changed, the maximum duration of operation for each zone depends on the power level selected. When the device for limiting the duration of use is activated, the cooking zone turns off. A short sound is emitted and if the zone is hot, the residual heat indicators are displayed.

Set power level	Maximum cooking duration in hours
1	8 ½
2	6 ½
3	5 ½
4	4 ½
5	3 ½
6 - 7 - 8 - 9	1 ½

Protection from overheating

If the hob is used on full power for a long period, the electronics will have trouble cooling down if the room temperature is high.

If the temperature of the internal electronic components exceeds the safety threshold, the appliance will switch off automatically and "ER21" will be displayed (see "Error codes").

Advice on energy-saving

- The diameter of the base of the pan must not exceed the width of the silk-screened cooking zone.
- Pans must not be placed outside the perimeter of the hob or above the front control panel.
- When buying a pan, check whether the diameter indicated is that of the base or the top of the pan, as the top is almost always larger than the base.
- When preparing dishes with long cooking times, you can save time and energy by using a pressure cooker, which also helps to retain vitamins contained in the food.
- Make sure that the pressure cooker contains enough liquid as, if there is not enough and it overheats, this may cause damage to both the pressure cooker and the cooking zone.
- If possible, always cover pans with a suitable lid.
- Choose a pan suitable for the quantity of food to be cooked. A large, half-empty saucepan leads to a waste of energy.





Under certain circumstances, if the hob and the oven are being used at the same time, the maximum power limit that can be used by the electrical system might be exceeded.



Power levels

The power in the cooking zone can be adjusted to various levels. The table shows the levels suitable for various types of cooking.

Power level	Suitable for:
0	OFF setting
	Keep warm/on the boil
1 - 2	Cooking small amounts of food (minimum power)
3 - 4	Normal cooking
5 - 6	Cooking large quantities of food, roasting larger portions
7 - 8	Roasting, slow frying with flour
9	Roasting
P /  	Roasting / Browning, cooking (maximum power)*

* see Booster and Double Booster function

Switching the hob on and off

Keep the On/Off button  pressed in for at least 1 second to activate the hob. Press it again for at least one second to deactivate it.





If no power value is selected within a few seconds, the hob is automatically deactivated.

Switching on the cooking zone automatically





The hob is provided with an automatic pan sensing system.



After switching on the hob:

- Position a pan (suitable for induction cooking and not empty) on the cooking zone you wish to use.
- The button corresponding to the zone on which the pan has been placed turns on automatically and displays . The corresponding radial LED will light up.
- Select the zone using the corresponding  button.

Adjusting the cooking zone

After selecting a cooking zone, use the  and  buttons to scroll through the power levels. Press and hold the above buttons to scroll more quickly.

The display of the zone being used will indicate the selected power level. The power level selection is cyclical. This means that when the maximum level (Booster or Double Booster) is selected, the



 button restarts the selection from level 0 and, from level 0 the levels can be selected in descending order using the  button.



Use

Switching off the cooking zone

Use the  or  buttons until level  is selected.

 Hold the On/Off button  down for at least 2 seconds to switch off all cooking zones at the same time.



Warming Function

 This function allows you to keep cooked food warm or to keep water on the boil. This corresponds to a power level of between **0** and **1**.

To activate the Warming function, first turn on the hob, then:

1. Select a cooking zone using the  button; the corresponding display shows



2. Press  again, the display of the selected cooking zone shows the 

symbol next to the  symbol.

To deactivate the Warming function, simply select any other power level or switch off the appliance.



Booster Function



Improper use Danger of burns

- Do not use the Booster and Double Booster functions to heat fats or oils as they could catch fire.

 This function allows you to use the maximum available power of the cooking zone in order to bring a large amount of water to the boil rapidly.



After switching on the hob and having selected a cooking zone, use the  or  buttons until the power level  is selected on the display. Select any other power level to deactivate the Booster function.



Double Booster Function (only for zones 3 and 4)

The Double Booster function allows more power to be supplied compared to the Booster function.

After having activated the Booster function for zones 3 or 4, press the  button.

Symbols   and  will be displayed in sequence. Select any other power level to deactivate the Double Booster function.



The Booster and Double Booster functions remain active for a maximum of 5 minutes, after which the power is reduced automatically to level 9.

Residual heat indicators



Improper use Danger of burns

- Supervise children carefully as they cannot easily see the residual heat indicators. The cooking zones remain hot for a certain period of time even after they have been turned off. Make sure that children never touch the hob.

After use, and even when the appliance is switched off, the displays of the cooking zones show the following symbols, in order

of increasing temperature:   and

, to indicate that the corresponding zone is still hot.

The relative residual heat indicators disappear as soon as the temperature falls below the safety threshold.

Cooking guidelines

The table below shows the power values which can be set, together with the corresponding type of food. Settings may vary depending on the amount of food and consumer taste.

Power level	Suitable for:
1 - 2	Reheating food, keeping small amounts of water on the boil, and whipping up sauces with egg yolk or butter.
3 - 4	Cooking solid or liquid food, keeping water on the boil, defrosting deep-frozen food, cooking 2- or 3-egg omelettes, fruit and vegetables, various cooking processes.
5 - 7	Stewing meat, fish and vegetables, simmering food, making jams etc.
8-9	Cooking or frying meat, fish, steaks and liver; browning meat, fish, eggs, etc.
Booster and Double Booster	Bringing water to the boil rapidly.





3.4 Special functions

Pause function





- This function pauses the operation of all the cooking zones and all the timers that are in progress.
- The Pause function can be maintained for a maximum of 10 minutes, after which the appliance switches off.

Press the  button to activate the Pause function when at least one cooking zone

active. The  symbol and the icon  will appear above the Pause button on the displays of all the cooking zones.

To deactivate the Pause function:

1. Press the  button.
2. Then press any button .
3. The pause function has now been deactivated and the previously set functions are restored.





- The cooking time limitation and the residual heat indicators remain enabled during the Pause function, while the Booster functions are deactivated.
- When the power comes back on after a power failure, the pause function will be deactivated.

Controls lock





This function allows you to disable all the buttons of the appliance, except for the  button. The lock remains active even if the hob is turned off and then on again.



This is useful to prevent functions being activated by mistake (e.g. by children). In order for the controls lock to be activated, the hob must be switched on, without pans and with the cooking zones set to **0**:

1. Press the  and  buttons at the same time; an acoustic signal is emitted.
2. Press the  button immediately; another acoustic signal is emitted.

The controls are now locked and the  symbols appear on the cooking zone displays. They flash for about 10 seconds, after which the hob switches off.

When the hob is switched on again, the cooking zone displays again show  :

- Press the  and  buttons at the same time to temporarily deactivate the controls lock. It will be restored the next time the appliance is switched on.
- To deactivate the controls lock permanently, follow the instructions described for activating it.

If a zone is hot, the  symbol will be displayed alternating with the  symbol.





3.5 Timer functions

Minute minder timer



- This function is used to set a timer that will emit a sound at the end of the pre-set time. It does not stop the operation of the cooking zones.
- The minute minder timer remains active even if the appliance is turned off.
- A maximum of 99 minutes can be set.

After having switched on the hob, without having selected a cooking zone:

1. Wait for about 10 seconds; the displays of the cooking zones start to flash.
2. Press the **TIMER** button.
3. The timer display shows  and the flashing LED below it lights up.
4. Press **TIMER** again to increase the number of minutes and  to decrease them. Keep the buttons pressed to increase or decrease the number of minutes more quickly.

After a few moments, the timer will start the countdown; the LED below it becomes steady.

When the time elapses, the timer display shows the figures "00" and a sound is emitted. Press any button to silence it.





When the countdown has less than one minute to go, the display shows the decreasing seconds and a flashing LED appears at the bottom right.

Modifying or deactivating the timer



If more than one timer is active, the timer display will show the minutes remaining for the timer that is closest to finishing.

To modify or deactivate the timer during the countdown:

1. Press the  button to activate the hob (if it is off) and wait 10 seconds. If the hob is on, press the **TIMER** button.
 - The timer display will show the minutes remaining.
2. Use the **TIMER** or  buttons to modify or reset the timer.
3. After a few moments, the timer will start the new countdown or will be deactivated.



Timed cooking



- This function is used to program the automatic switch-off of each cooking zone at the end of the required time.
- Timed cooking can be set for all cooking zones.
- An independent timer can be set together with timed cooking timers.
- A maximum of 99 minutes can be set.

To set timed cooking, you first have to select a cooking zone using one of the  buttons.

After having selected the relevant cooking zones, the setting, modification and deactivation of the timed cooking timers follows the same logic as the minute minder timer (see the relative instructions - "Timer functions").

Once a timed cooking timer has been activated, a LED will come on around the timer display indicating the position of the relative cooking zone (e.g. front left zone



and rear right zone: ).

Recall Function



This is used to restore some functions that have already been started after the appliance has been switched off unintentionally.

If the appliance is switched off unintentionally, carry out the following procedure within 6 seconds:

1. Switch on the appliance.
- The flashing  symbol appears on the cooking zone displays.
2. Press the pause button  immediately to restore the functions that were previously active.

Restorable functions:

- 1 Cooking zone power levels.
- 2 Minute minder timer and timed cooking timer.
- 3 Heating accelerator.
- 4 Booster and Double Booster Functions.
- 5 Controls lock.

No other functions will be restored.



3.6 Error codes

If the appliance malfunctions or operates incorrectly, the associated error code appears on the cooking zones display.

The error codes always begin with "E." or "Er.", followed by a number.

The following error codes can be corrected without having to contact the Technical Support Service.

- **Er03:** Remove any materials or pans from the area of the front control panel.
- **E2:** Make sure that the pans are suitable for induction cooking and that they are not empty; allow the appliance to cool down.



If these error codes appear frequently, contact Technical Support.

For all other errors, make a note of the code, if possible, and contact Technical Support.



4 Cleaning and maintenance

4.1 Instructions



Improper use

Risk of damage to surfaces

- Do not use steam jets to clean the appliance.
- Do not spill sugar or sweet mixtures on the hob during cooking.
- Do not place materials or substances that could melt (plastic or aluminium foil).
- Keep sensor buttons clean at all times and do not rest any object on them.
- Do not use cleaning products containing chlorine, ammonia or bleach on parts made of steel or that have metallic surface finishes (e.g. anodizing, nickel- or chromium-plating).
- Do not use abrasive or corrosive detergents (e.g. scouring powders, stain removers and metallic sponges) on glass parts. Use wooden or plastic utensils.

4.2 Cleaning the surfaces

To keep the surfaces in good condition, they should be cleaned regularly after use. Let them cool first.

4.3 Ordinary weekly cleaning

Clean and maintain the hob once a week using an ordinary glass cleaning product. Always follow the manufacturer's instructions. The silicon in these products creates a protective, water-repellent membrane which also resists dirt. All marks stay on the membrane and can therefore be removed easily. After cleaning, dry the surface with a clean cloth. Make sure that there is no detergent left on the cooking surface as it will undergo a corrosive reaction when heated up and could modify the structure of the cooking surface.

4.4 Food stains or residues

Light coloured marks from pans with aluminium bases can be easily cleaned off with a cloth moistened in vinegar.

Remove any burnt-on residues after cooking; then rinse with water and dry thoroughly with a clean cloth.

Dirt which may have fallen on the hob while cleaning lettuce or potatoes can scratch the hob when moving pans.

Consequently, remove any dirt from the cooking surface immediately.



Changes in colour do not affect the operation and stability of the glass. These are not alterations to the material of the hob but just residues which have not been removed and have then carbonised.

Shiny surfaces can form due to the bases of pans, especially aluminium ones, rubbing on the surface, and due to the use of unsuitable detergents. They are difficult to remove using conventional cleaning products. It may be necessary to repeat the cleaning process several times. Use of corrosive detergents or rubbing of pan bases can wear away the decoration on the hob over time and contribute to the formation of stains.

4.5 What to do if...

The hob does not work:

- Make sure that the hob is connected and that the main switch is turned on.
- Make sure that there is no power failure.
- Make sure that the fuse has not blown. In this case replace the fuse.
- Make sure that the circuit breaker of the residential electrical system has not tripped. In this case, reset the circuit breaker.

The cooking results are unsatisfactory:

- Make sure that the cooking temperature is not too high or too low.

The hob smokes:

- Let the hob cool down and clean it once cooking is complete.
- Make sure that the food has not spilled out of the pan and use a larger cooking vessel, if needed.

The fuses blow or the circuit breaker of the residential electrical system trips repeatedly.

- Call Technical Support or an electrician.

There are cracks or fissures in the hob:

- Turn off the appliance immediately, disconnect the power supply and contact Technical Support.



Installation

5 Installation

5.1 Electrical connection



Power voltage
Danger of electrocution

- Have the electrical connection performed by authorised technical personnel.
- Use personal protective equipment.
- The appliance must be connected to earth in compliance with electrical system safety standards.
- Disconnect the mains supply.
- Do not pull the cable to unplug the appliance.
- Use cables withstanding a temperature of at least 90°C.
- The tightening torque of the screws of the terminal supply wires must be 1.5 - 2Nm.

General information

Check the grid characteristics against the data indicated on the plate.

The identification plate bearing the technical data, serial number and brand name is visibly positioned on the appliance. Do not remove this plate for any reason.

Perform the ground connection using a wire that is 20 mm longer than the other wires.

The appliance, depending on the model, can be connected as follows:

- **380-415 V 3N~**

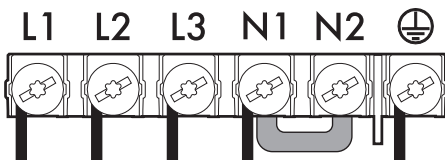

5 x 2.5 mm² five-core cable.

- **220-240 V 3~ / 380-415 V 2N~**

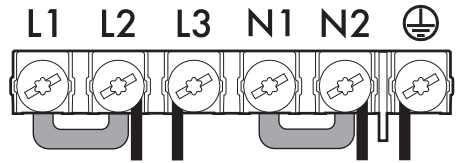

4 x 4mm² four-core cable.

- **220-240 V 1N~**

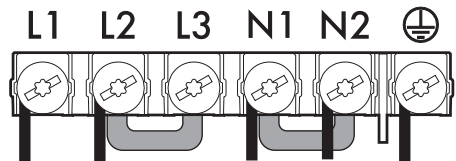

5 x 4 mm² five-core cable



For all types of connection, always use the jumpers provided.

Fixed connection

Fit the power line with an all-pole circuit breaker in compliance with installation regulations.

The circuit breaker should be located near the appliance and in an easily reachable position.



Run the power cable in the rear part of the unit. Make sure that it does not come into contact with the lower part of the hob or a built-in oven below it.



Be careful when connecting additional electrical appliances. Connection cables must not come into contact with hot cooking zones.

Testing

At the end of installation, carry out a brief inspection test. If the hob fails to operate, after checking that you have carried out the instructions correctly, unplug the appliance and contact Technical Support.

5.2 Instructions for the installer

- Do not bend or trap the power cable.
- The appliance must be installed according to the installation diagrams.
- If the appliance does not work correctly after having carried out all the checks, contact your local Authorised Service Centre.
- Once the appliance has been installed, please explain to the user how to use it correctly.

5.3 Power limitation procedure (for installer only)



- This appliance is factory set to operate at **7.4 kW**.
- The technical menu has a total of 4 options. They are indicated by the letter "C" and a progressive number. They have different levels of adjustment.

Accessing the technical menu

In order to modify the maximum power absorbed by the appliance, you have to access the technical menu. When connecting to the mains supply for the first

time or after disconnecting and reconnecting the appliance, follow these instructions within 2 minutes:

1. Press and hold .
2. With the button pressed, press ; an acoustic signal is emitted.
3. Immediately afterwards, press the button of the front left zone; another acoustic signal is emitted.

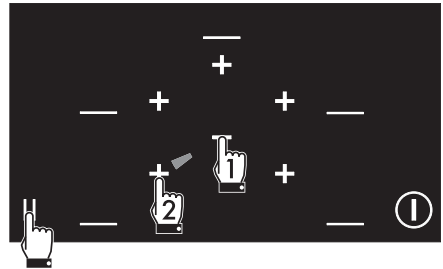

You have now accessed the technical menu and the buttons can be released.

The display of the front left zone shows the code associated with the option: the symbol appears alternating with .

The rear left zone display shows the adjustment levels corresponding to the power levels.

They can be selected using the button of the front left zone.



You can only scroll through the levels in the upwards direction: once the maximum level has been reached, the selection starts from the beginning again.



Installation



Using the  button in the technician menu, you can access the options indicated by codes "C1", "C2" and "C3", but it is not possible to select the level of adjustment.

To exit from the technical menu without saving the changes:



1. Press the  button; the appliance will be restarted.

Power level adjustments table

Adjustment level	Power level (kW)
0 (default)	7.4
1	6.0
2	5.5
3	5.0
4	4.5
5	4.0
6	3.6
7	3.0
8	2.5

Exiting from the technical menu

To exit from the technical menu and save the changes:

1. Press the  button, all the cooking zone displays show the  symbol and an acoustic signal is emitted.
2. Press any button; all the indicator lights come on for a few seconds and the appliance switches off.

5.4 Safety instructions



Heat production during appliance operation
Risk of fire

- Check that the carcass material is heat resistant.
- Check that the carcass has the required openings.
- Do not obstruct the ventilation grille in front of the product during mounting.

Veneers, adhesives or plastic coatings on adjacent furniture should be temperature-resistant (>90°C), otherwise they might warp over time.



The minimum clearance between exhaust hoods and the cooking surface must be at least the distance indicated in the exhaust hood installation instructions.

The minimum clearances must also be respected for the edges of the hob on the back as indicated in the mounting illustrations.

5.5 Section cut from the countertop



The following operation requires building and/or carpentry work and must therefore be carried out by a competent tradesman. Installation can be carried out on various materials such as masonry, metal, solid wood or plastic laminated wood as long as they are heat resistant (>90°C).

Make a hole in the countertop of the unit according to the dimensions shown in the figure (mm).

Dimensions for flush mounting

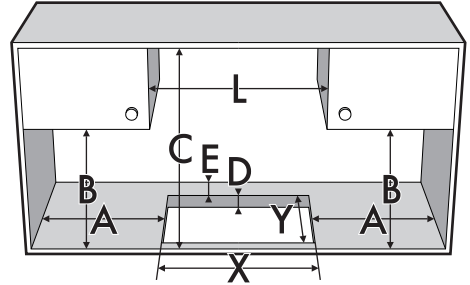
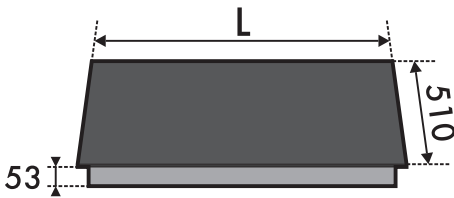

L		X		Y	
900		839 ÷ 844		482 ÷ 486	
A	B	C	D	E	
min. 50	min. 460	min. 750	20÷60	min. 50	

Hob seal

To prevent leakage of liquid between the frame of the hob and the countertop, place the adhesive seal provided along the entire outer edge of the hob before assembly.

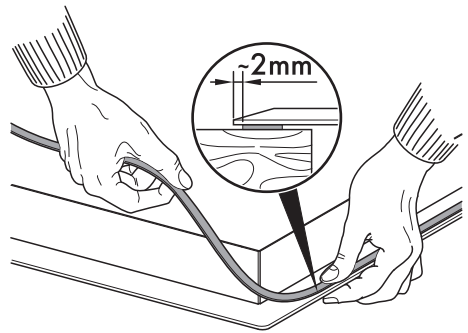

Do not use silicone to secure the hob. This would make it impossible to remove the hob, if necessary, without damaging it.



Installation

Flush built-in model

For this kind of hobs additional milling is needed in the recessed hole if you wish to install the hob flush with the work surface.

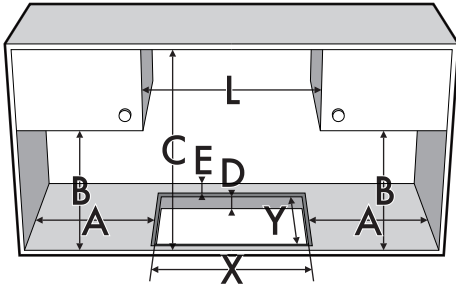
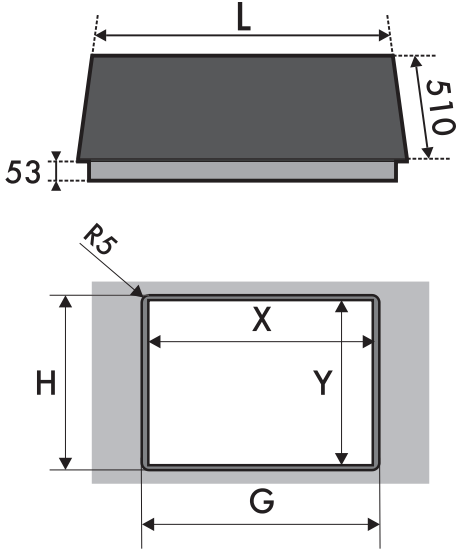

L	H	G	X	Y
900	514	904	839 ÷ 844	482 ÷ 486
A	B	C	D	E
min. 50	min. 460	min. 750	20 ÷ 60	min. 50

After laying the adhesive seal (A) on the glass surface and after positioning and securing the hob, fill the edges with insulating silicone (B) and wipe away any excess.

In the event the hob needs to be removed, cut the silicone using a cutter before attempting to remove it (C).

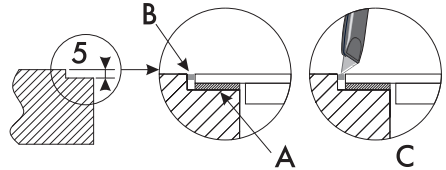

5.6 Mounting

Over built-in oven unit



If installed on top of an oven, the latter must be equipped with a cooling fan.

The clearance between the hob and the kitchen units or other built-in appliances must be enough to ensure sufficient ventilation and air discharge. If installed above an oven, a space must be left between the bottom of the hob and the top of the appliance installed below.

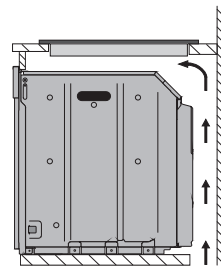

opens on bottom

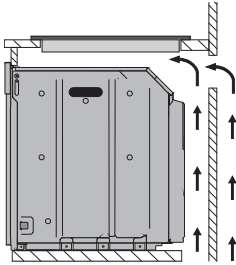

opens on bottom and on rear

On top of an empty kitchen unit or drawers

If there are other pieces of furniture (lateral walls, drawers, etc.), dishwashers or fridges under the hob, a double-layer wooden base must be installed at least **20 mm** from the bottom of the hob to avoid any accidental contact. It must only be possible to remove the double-layer base using suitable equipment.

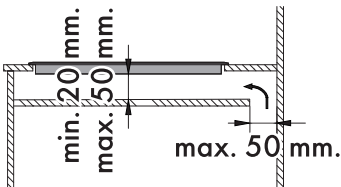
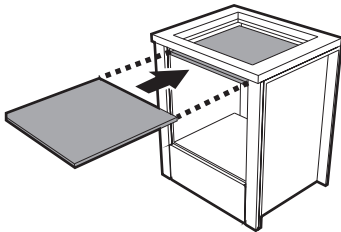

opens on bottom

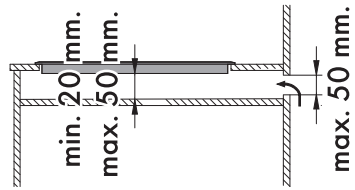

opens on rear



Failure to install the double-layer wooden base exposes the user to possible accidental contact with sharp or hot parts.

Ventilation

The illustrations below show two examples of installation suitable for proper ventilation and one example of incorrect installation to be avoided.

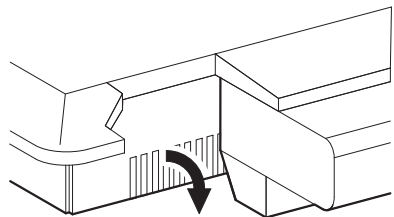
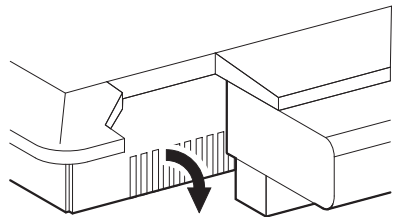

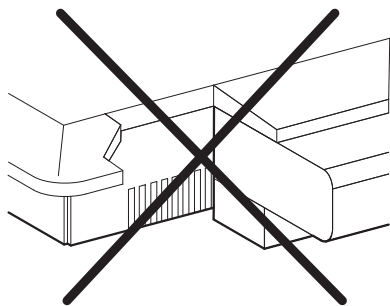

Spring clips

To ensure the hob is fixed and centred as accurately as possible, the clips provided must be positioned as described below:

1. Fit the clips by gently pressing them horizontally into the appropriate space.

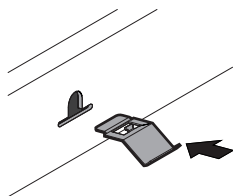

2. Then turn them upwards to fix them in place.

