

SEARS

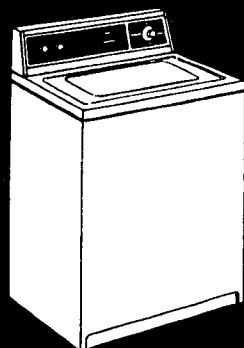

Washer

INSTALLATION INSTRUCTIONS

Read This First

Be sure you have the proper electrical connection, adequate drain and enough space for installation. Read the installation instructions all the way through before starting. **DO NOT PLUG THE POWER SUPPLY CORD IN UNTIL INSTRUCTED TO DO SO** (Step 13).

Electricity

OBSERVE ALL GOVERNING CODES AND ORDINANCES.

A 120 volt, 60 Hz, AC only, 15 or 20 ampere fused electrical supply is required (time delay fuse or circuit breaker is recommended). It is recommended that a separate circuit serving only this appliance be provided.

⚠ WARNING

Electrical Shock Hazard

- Electrical ground is required on this appliance.
- If cold water pipe is interrupted by plastic, non-metallic gaskets or other insulating materials, Do Not use for grounding.
- Do Not ground to a gas pipe.
- Do Not modify the power supply cord plug. If it does not fit the outlet, have a proper outlet installed by a qualified electrician.
- Do Not have a fuse in the neutral or grounding circuit. A fuse in the neutral or grounding circuit could result in an electrical shock.
- Do Not use an extension cord with this appliance.
- Check with a qualified electrician if you are in doubt as to whether the appliance is properly grounded.

Failure to follow these instructions could result in serious injury or death.

If codes permit and a separate grounding wire is used, it is recommended that a qualified electrician determine that the grounding path is adequate.

RECOMMENDED GROUNDING METHOD

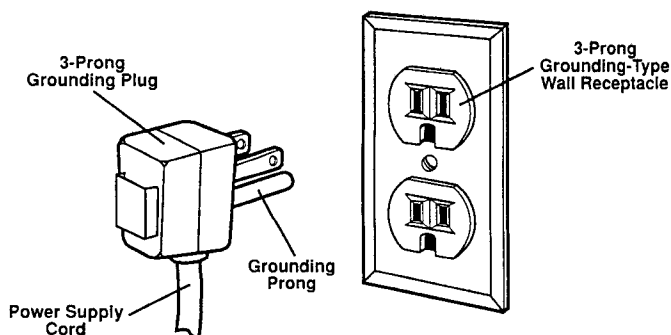

FIGURE 1

For your personal safety, this appliance must be grounded. This appliance is equipped with a power supply cord having a 3-prong grounding plug. To minimize possible shock hazard, the cord must be plugged into a mating 3-prong grounding-type wall receptacle, grounded in accordance with National Electrical Code, ANSI/NFPA 70-latest edition and all local codes and ordinances. See Figure 1. If a mating wall receptacle is not available, it is the personal responsibility and obligation of the customer to have a properly grounded 3-prong wall receptacle installed by a qualified electrician.

Water Supply

OBSERVE ALL GOVERNING CODES AND ORDINANCES

Hot and cold water faucets must be located within 4 feet of your washer's water inlets. Measure this to be sure. The faucets must be threaded for hose connection. You must have between 5 and 100 pounds per square inch water pressure. Ask your water department or pump installer. Place your washer where its inlet valve is protected from freezing. See FIG. 4.

Be sure to run about one gallon of water from each faucet to flush out any particles before connecting washer inlet hoses.

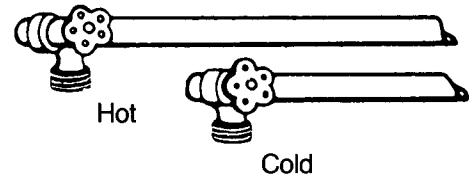

FIGURE 4

Drainage

OBSERVE ALL GOVERNING CODES AND ORDINANCES

Your washer must drain into a 20-gallon tub or a 2-inch diameter standpipe. The drain should be able to carry away 17 gallons per minute. The end of the drain hose must be more than 34 inches but less than 72 inches above the base of the washer. If you run a drain hose to a floor drain you MUST install a siphon break. (Part No. 285320 at Sears Service Dept.) NOTE: If you use less than a 2-inch diameter standpipe you MUST run the washer through a complete cycle to be sure the drain is adequate. There must be an air gap around the drain hose inside the standpipe. A snug fit can cause siphoning action. See FIG. 5.

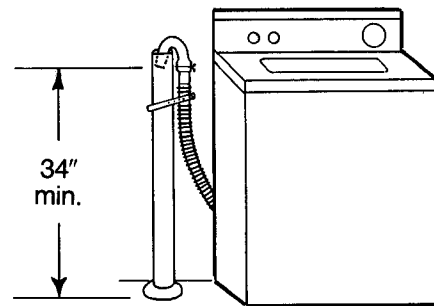

FIGURE 5

Floor Support

The floor beneath the washer should be level, no more than 1-inch slope under the entire washer. The floor must be strong enough to support the weight of the washer when it is filled, about 315 pounds.

TYPICAL INSTALLATIONS OF SEARS AUTOMATIC WASHERS

These drawings show you a choice of ways to install your washer.
Study the drawings to see which one applies to you.

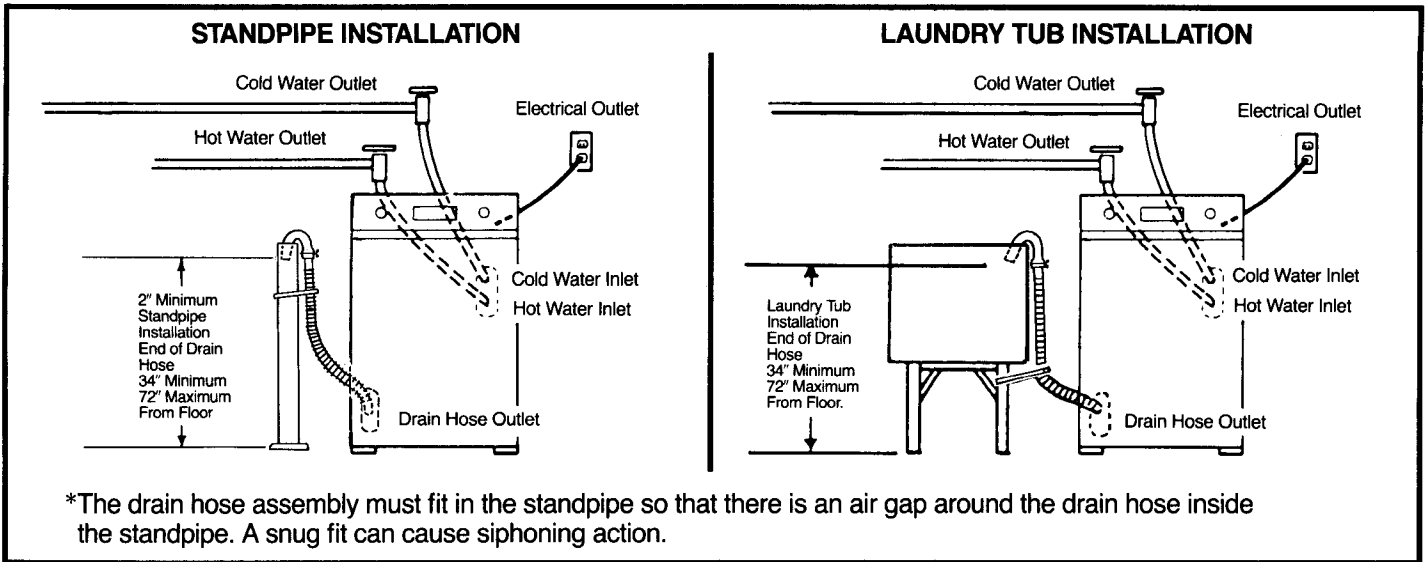

RECESSED AREA INSTRUCTIONS

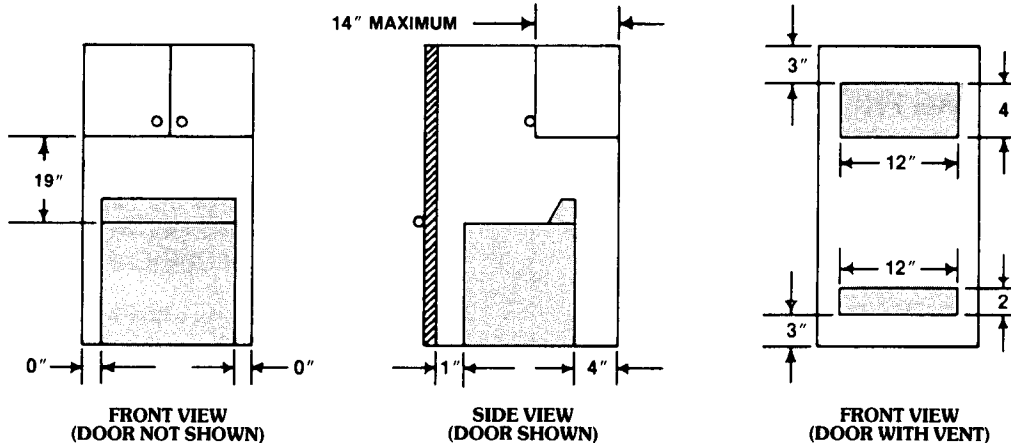

MINIMUM INSTALLATION SPACING

The installation spacing and door opening areas shown are the minimum required for this washer. DIMENSIONS ARE IN INCHES.

Too little space and vent area means there is not enough air moving around your washer. This can cause heat and moisture to build up in the air. Your washer and the area where it's installed could be damaged.

When a door is installed, open areas of at least 48 sq. in. top and 24 sq. in. bottom are required in the door. A

louvered door with air openings at the top and bottom is acceptable. Minimum openings are shown above.

NOTE: Companion appliance spacings should be considered.

Special Reminder: Make sure to shut off the water supply faucets when the washer is not in use.

SERVICE SAVER INSTRUCTIONS ARE ON BACK PAGE.

DRAIN PROTECTOR

On installations where "chunks" of lint may cause problems with the drain, it may be necessary to install a Drain Protector (Part No. 367031 available through your Sears service department). The Drain Protector will stop the lint from being discharged into the drain. Its function is to break up the large "chunks" of lint into smaller particles and catch threads and strings.

To install the Drain Protector, push it into the washer drain hose as shown. It is recommended that a short piece of hose be placed on the outlet end to prevent splash in a laundry tub or to insure that the Drain Protector will not fall out of the standpipe and discharge water onto the floor.

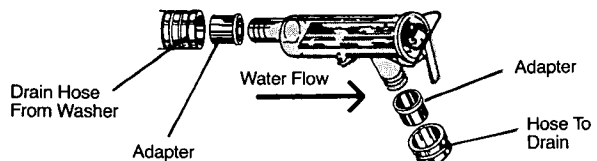

To Install Washer

Read these instructions all the way through before starting to install your washer. Follow the steps in order. **DO NOT PLUG THE POWER SUPPLY CORD IN UNTIL INSTRUCTED TO DO SO** (Step 13).

SAVE THESE INSTRUCTIONS

TOOLS

For most installations all you need is:

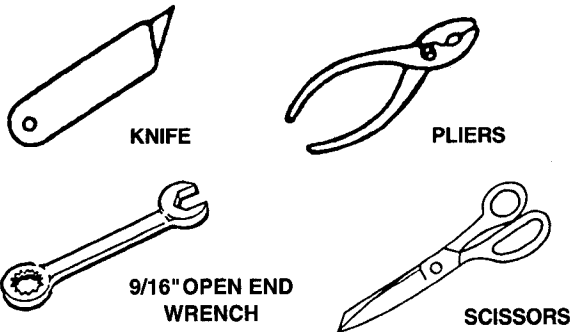

REMOVE WATER INLET HOSES AND DRAIN HOSE FROM WASHER.

REMOVE PARTS BAG FROM WASHER.

It contains:

- | | |
|-----------------------------|-------------------------|
| 2 Front Legs With Lock Nuts | 1 Drain Connector Clamp |
| 4 Inlet Hose Washers | 1 Drain Hose End Clamp |

STEP 1

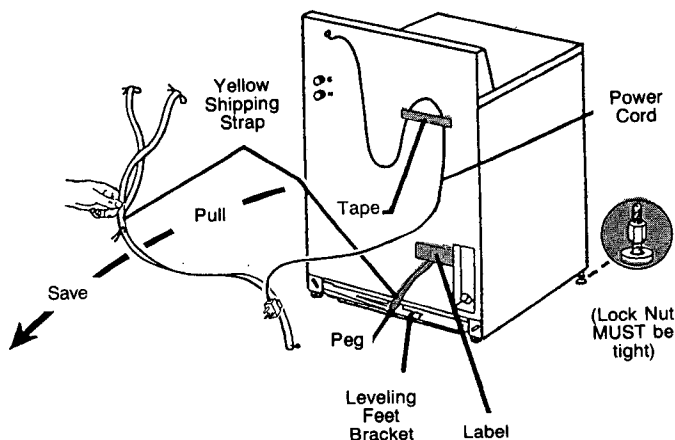
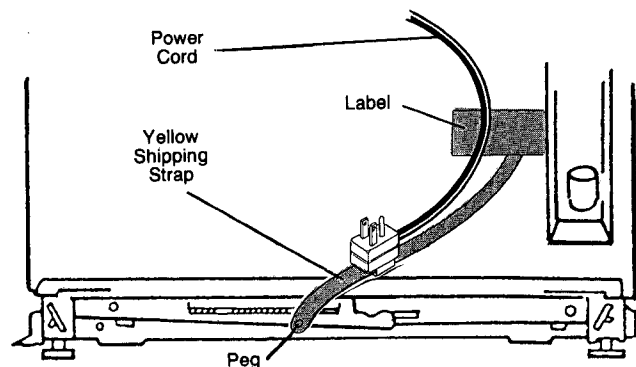

Pull the yellow shipping strap with three keys, peg and the power cord attached to it and remove it **COMPLETELY** from the washer. Save the strap for use in STEP 5.

⚠ CAUTION

Product Damage

Washer will vibrate excessively and could be damaged if yellow shipping strap with three keys and peg is not completely removed.

NOTE: Be sure all three keys and peg come out with the strap; if they do not, service may be needed.

STEP 2

Move the washer close to the spot where it will be used. **USE CAUTION WHEN MOVING THIS APPLIANCE TO PREVENT DAMAGE TO FLOOR COVERINGS.** The weight of the appliance may cause ripping, scratching or other damage to the floor. For best results, slide appliance onto cardboard or fiberboard before moving to prevent damage.

STEP 3

To prevent the Drain Hose from coming off or leaking, it must be installed per the following instructions;

1. Wet the inside end of the Drain Hose with tap water. **DO NOT USE ANY OTHER LUBRICANT.**
2. Squeeze ears of Clamp with Pliers to open and place Clamp over the end of the Drain Hose.
3. While holding Clamp open work end of Drain Hose onto Drain Connector until Drain Hose is within 1/4" of Ribbed Stop.
4. When the end of the Drain Hose is within 1/4" of Ribbed Stop, position Clamp on Drain Hose so that the bottom of the Clamp is 1/4" from the end of the Hose, release pliers.

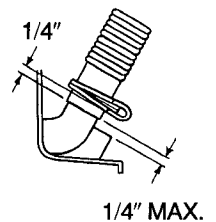
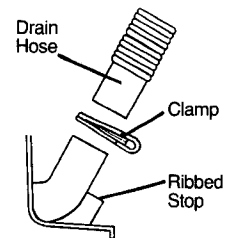

IMPORTANT: THE ABOVE PROCEDURE MUST BE FOLLOWED TO ASSURE PROPER INSTALLATION.

STEP 4

Place the formed rubber end of the drain hose in a drain tub or standpipe. The formed rubber end of the drain hose swivels so the hose can be put into the tub or standpipe without kinking. A clamp holds the end in position. After setting the formed rubber end of the drain hose, secure it on the hose with the single wire clamp from the parts bag. The end of the drain hose must be at least 34 inches above the floor but not more than 72 inches.

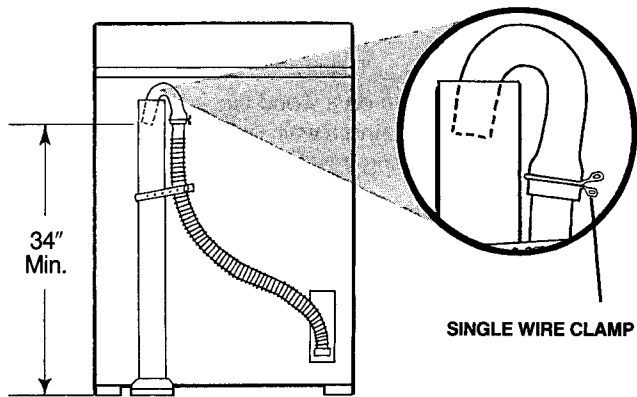

The drain hose must fit into the standpipe so there is an air gap all around it. A snug fit may cause siphoning.

NOTE: The end of the drain hose **MUST** be at least 34 inches above the floor, but not more than 72 inches.

STEP 5

⚠ CAUTION

Possible Property Damage

Failure to secure the drain hose with the shipping strap could allow the hose to come loose and result in water damage to the floor.

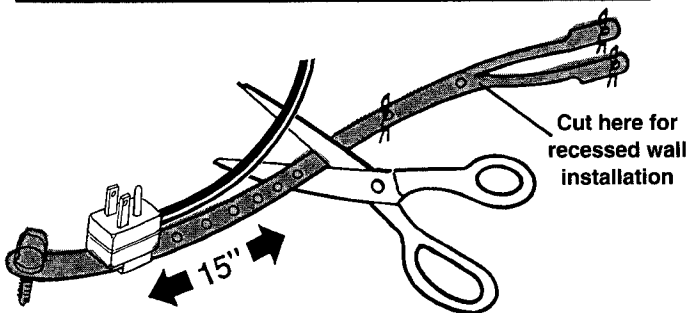

After the yellow shipping strap has been removed from the washer, cut it about 15 inches from the end with the peg. Pull the strap with the peg out of the power cord plug.

Use the portion of the shipping strap with the peg to secure the drain hose to the drain tub or standpipe.

Dispose of the rest of the strap.

⚠ CAUTION

- FAILURE TO SECURE DRAIN HOSE COULD RESULT IN WATER DAMAGE TO FLOOR.
- DO NOT FORCE EXCESS LENGTH OF DRAIN HOSE DOWN STANDPIPE. THIS COULD CAUSE SIPHONING.

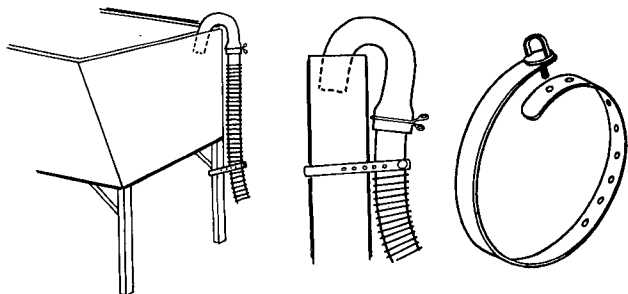

Wrap the strap around the drain hose and tub leg or standpipe until it is tight, then push the peg through the nearest hole in the strap.

Recycling this portion of the shipping strap instead of throwing it away can help the environment by conserving landfill space. We also suggest you save the pins for another use.

If the drain standpipe is directly behind the washer, be sure to measure the drain hose. If the drain hose must be shortened order Hose Kit, Part No. 285442 from Sears Service Dept. The drain hose must fit into the standpipe so there is an air gap all around it. A snug fit may cause siphoning action.

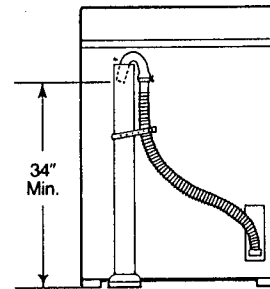

If needed, additional drain hose Part No. 388423 and Hose Kit Part No. 285442 can be purchased from your local Sears Service Dept.

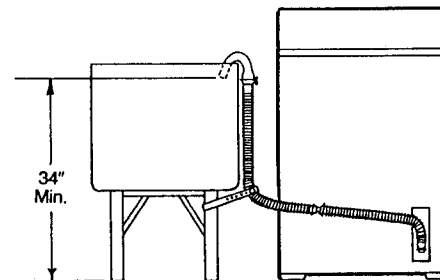

When water faucets and standpipe are built into the wall, secure the drain hose with the shipping strap as follows:

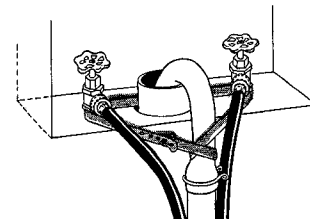

- A. Wrap the shipping strap around the water faucet bodies, (Do not wrap around handles or stems) and the drain hose in a "figure 8". Secure the strap with the peg through the nearest hole.

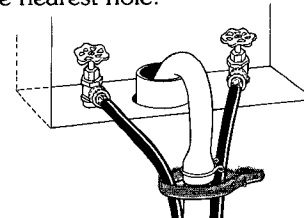

- B. Wrap the shipping strap around the drain hose and the water inlet hoses. Secure the strap with the peg through the nearest hole.

STEP 6

Run a little water from the HOT and COLD water faucet into a pail to remove any particles from the line. Note which faucet is hot and which is cold.

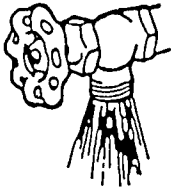

Put a flat washer from the parts bag into each end of the four inlet hose couplings. Be sure flat washers are *firmly* seated.



FLAT WASHER

Attach hoses to faucets.

HOSE COUPLING

Tighten couplings by hand, then another $\frac{2}{3}$ turn with pliers.

STEP 7

Attach other ends of hoses to washer.
Attach HOT water hose to the BOTTOM washer inlet.
Attach COLD water hose to TOP washer inlet.
Tighten couplings by hand, then another $\frac{2}{3}$ turn with pliers.
Do not crossthead or overtighten, this could cause leaks.

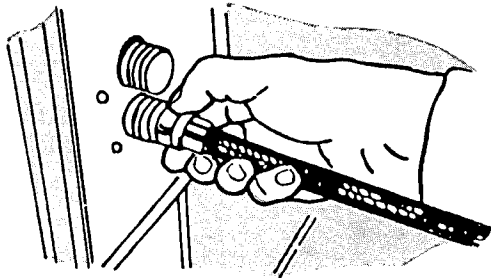

STEP 8

Turn the water faucets on and check for leaks. If there is a leak, make sure the flat washers are in place in all four hose couplings. Tighten couplings to stop leaks. **DO NOT OVERTIGHTEN**, this could cause damage to faucet.

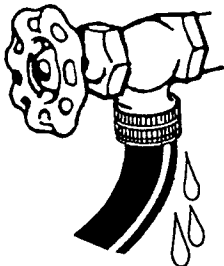

STEP 9

Move washer to the exact spot where it will be used. Remove the cardboard or hardboard from under washer.

STEP 10

INSTALL LEVELING LEGS

Prop front of washer up on a wood block (about 4 inches). If washer was placed against a wall, it may have to be moved out slightly before tipping it to prop it up.

Set lock nuts on front legs to $\frac{1}{2}$ inch from top of leg base. Screw legs into mounting holes in front corners of washer until lock nut touches the washer base. Do not tighten nuts yet.

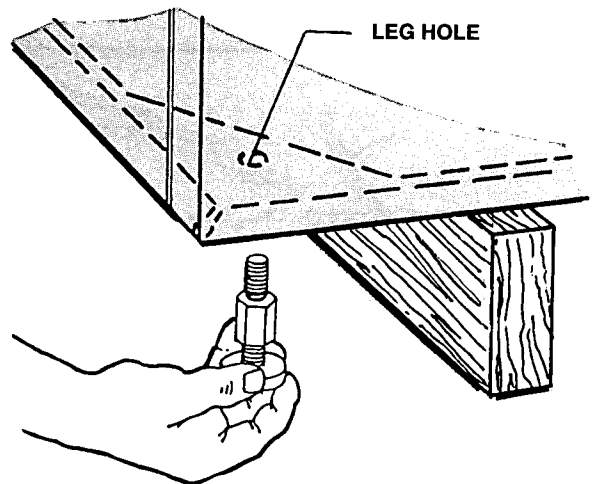
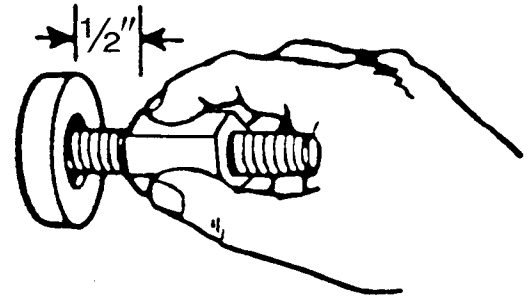

Remove the wood block and gently lower the washer to the floor.

STEP 11

The rear legs are self leveling. They were released when you pulled out the shipping strap. Adjust them by tilting the washer forward slightly (about an inch) and gently setting it back down.

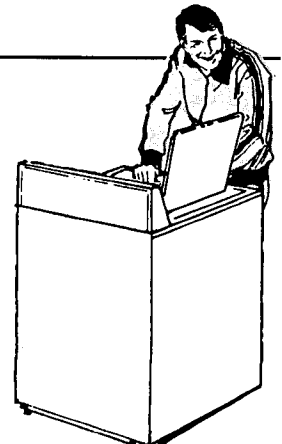

STEP 12

Use a carpenter's level to make sure washer is level front to back and side to side. You may use a pan of water filled to a mark instead of a carpenter's level.

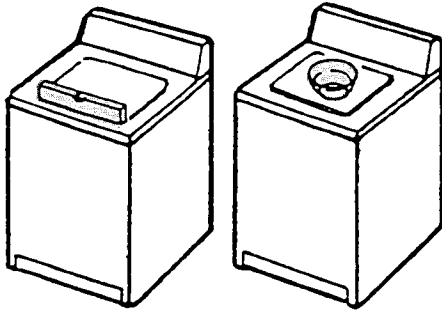

TO LEVEL WASHER

- Determine which side of washer should be raised or lowered.
- Prop front of washer up on a wood block about 4".
- Adjust front legs by turning them in or out (loosen lock nut to turn legs in).
- Turn lock nuts until they touch washer base.
- Remove wood block and gently lower washer to the floor.
- Adjust rear leveling legs. Tilt washer forward to raise back about 1 inch. Set back on floor.
- Check to see if washer is level. If not repeat steps above.

When washer is level, tighten lock nuts on the front legs with a $\frac{3}{16}$ " open end wrench.

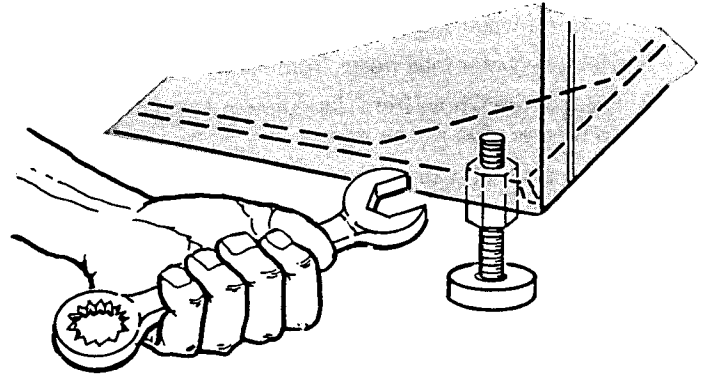

VERY IMPORTANT: BE SURE LOCK NUTS ARE TIGHT TO PREVENT VIBRATION.

STEP 13

BE SURE WASHER IS GROUNDED AS SHOWN ON PAGE 1.

Push the washer cycle selector in and turn it right to OFF. Plug the electric power supply cord into a grounded receptacle if you have followed the instructions for grounding the washer.

Read all the operating instructions for your washer. Then run it through an entire cycle. Keep literature handy in a binder or drawer for future use.

Before Moving Washer To A New Location

1. Remove electric plug from socket.
2. Remove electrical ground wire if one was used.
3. Coil electrical power cord and tape to back of washer.
4. Turn off water faucets.
5. Remove water inlet hoses from faucets and washer.
6. Remove drain hose from standpipe or tub. Tape drain hose to washer. Do not let it kink.
7. Tape sides of washer to base at bottom about 4 inches in from back.
8. Prop washer up about 4 inches on a block of wood. Loosen lock nuts on front legs. Remove and save front legs and lock nuts.

9. Push rear leveling legs up and tape securely.
10. Stuff a blanket between the top of the washer basket and lid EXCEPT in the area where the probe of the safety lid switch enters the washer.
11. Tape washer lid closed.
12. Washer is ready for moving.

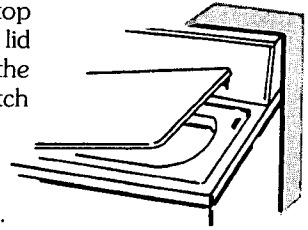

NOTE: When washer is reinstalled, use new inlet hoses.

Service Saver Instructions

If your washer is not operating properly, check (and correct) the following before calling for service.

SERVICE SAVER INSTRUCTIONS				CHECK THESE POINTS FIRST... BEFORE YOU CALL FOR SERVICE	
IF YOUR WASHER...			CHECK THIS...		
VIBRATES	WONT DRAIN	DRAINS AS IT FILLS	INSTALLATION		
			POSSIBLE CAUSE	ACTION	
•			YELLOW SHIPPING STRAP WITH KEYS AND PEG NOT COMPLETELY REMOVED.	• REMOVE STRAP.	
•			NUTS ON FRONT FEET NOT TIGHT.	• TIGHTEN NUTS.	
•			REAR LEVELING LEGS NOT SET.	• SET REAR LEVELING LEGS.	
•			WASHER IS NOT LEVEL.	• LEVEL WASHER.	
•			FLOOR NOT STRONG ENOUGH TO SUPPORT FILLED WASHER (APPROX. 315 LBS.).	• RELOCATE WASHER.	
•			LOAD OFF BALANCE.	• REDISTRIBUTE LOAD.	
	•		END OF DRAIN HOSE MORE THAN 72 INCHES ABOVE FLOOR.	• LOWER DRAIN HOSE.	
	•		DRAIN HOSE KINKED OR PLUGGED.	• STRAIGHTEN OR UNPLUG HOSE.	
	•		DRAIN CLOGGED.	• CLEAR DRAIN.	
		•	DRAIN HOSE LESS THAN 34 INCHES ABOVE FLOOR.	• RAISE DRAIN HOSE.	
		•	DRAIN HOSE FITS TIGHTLY INTO STANDPIPE.	• ADJUST DRAIN HOSE FOR LOOSE FIT.	
			OPERATION		
WONT FILL	WONT SPIN	STOPS	POSSIBLE CAUSE	ACTION	
•	•	•	POWER CORD NOT PLUGGED INTO ELECTRIC OUTLET.	• PLUG IN CORD.	
•	•	•	FUSE BLOWN OR CIRCUIT BREAKER OPEN.	• REPAIR CIRCUIT.	
•	•	•	CONTROL ON "OFF" OR TIMER KNOB NOT PULLED OUT.	• SET AND PULL OUT KNOB.	
•			WATER INLET HOSES PLUGGED OR KINKED.	• FLUSH OR STRAIGHTEN HOSES.	
•			WATER INLET VALVE SCREENS PLUGGED.	• CLEAN SCREENS.	
•			WATER FAUCETS OFF.	• TURN ON BOTH FAUCETS FULLY.	
•			LOW WATER PRESSURE.	• CORRECT PLUMBING.	
	•		SUDS LOCK -- CAUSED BY TOO MUCH DETERGENT.	• REWASH WITHOUT DETERGENT.	
	•	•	LID IS OPEN.	• CLOSE LID.	
		•	WASHER AT PAUSE IN PERMANENT PRESS CYCLE.	• ALLOW CYCLE TO CONTINUE.	

FOR EACH CONDITION, CHECK ALL SUGGESTED CAUSES. REFER TO INSTALLATION INSTRUCTIONS FOR CORRECT INSTALLATION. IF NOT CORRECTED, CALL SEARS SERVICE. PLEASE HAVE MODEL NUMBER AND PURCHASE DATE READY.

SEARS

SEARS, ROEBUCK AND CO., 3333 Beverly Road, Hoffman Estates, IL 60179



Printed on recycled paper.
10% post consumer waste/
50% recovered materials.

PART NO. 3361040

Printed in U.S.A.