

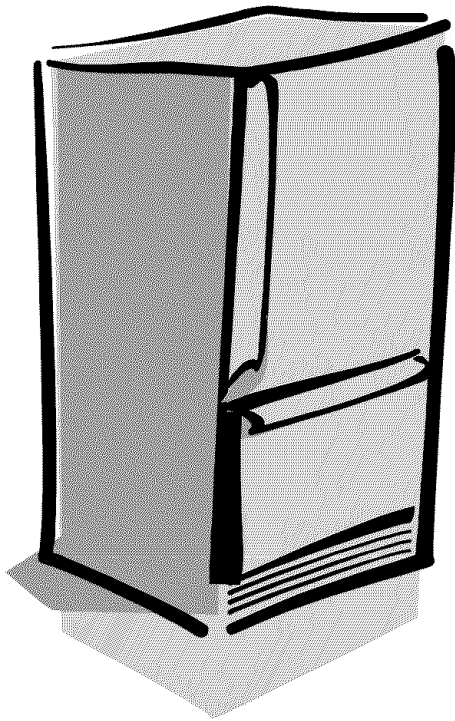

# Owner's Manual



## Bottom Freezer Refrigerator

Ordering parts and accessories?  
Questions about your features?

Please contact us with your model and serial number:

Consumer Affairs Department  
Amana Appliances  
2800 - 220th Trail  
Amana, Iowa 52204  
Ph# 1(800)843-0304 in U.S.A.  
1(866)587-2002 au Canada  
Internet: <http://www.amana.com>

Keep instructions for future reference.  
Keep this manual and your sales receipt together in a safe place in case warranty service is required.

### Contents

Introduction .....	2
Important Safety Information .....	3
Installing Your Refrigerator .....	4
How to Remove the Doors and Hinges .....	4
How to Reverse the Doors .....	5
How to Install and Remove Handles .....	5
How to Replace the Doors and Hinges .....	6
How to Remove and Install the Pullout Drawer .....	7
How to Connect the Water Supply .....	8
How to Level Your Refrigerator .....	9
How to Adjust the Temperature Controls .....	9
Fresh Food Features .....	10
Interior Shelves .....	10
Door Storage .....	10
Accessories .....	10
Climate-Controlled Drawers .....	11
Storage Drawers .....	11
Freezer Features .....	12
Primary Features .....	12
Shelves .....	12
Drawers .....	12
Door Storage .....	12
Accessories .....	13
Hints and Care .....	14
How to Clean Your Unit .....	14
How to Remove and Replace Light Bulbs .....	15
Trouble Shooting .....	16
Warranty .....	19

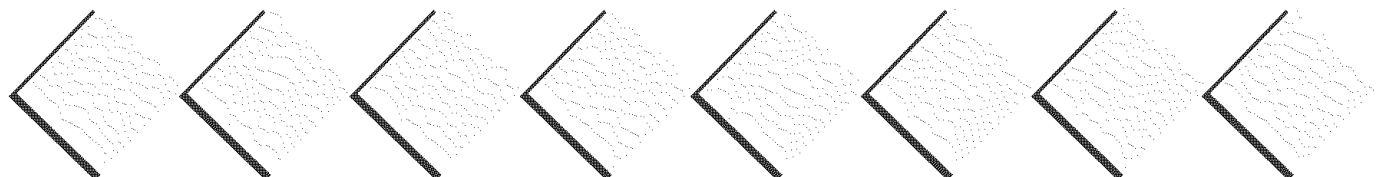

# Thank you for buying an Amana refrigerator!

Please read this Owner's Manual thoroughly. This manual provides proper maintenance information.

**Complete registration card and promptly return.** If registration card is missing, call the Consumer Affairs Department.

**Warranty service must be performed by an authorized servicer.** Amana also recommends contacting an authorized servicer if service is required after warranty expires. To locate an authorized servicer, call **1-800-NAT-LSVC (1-800-628-5782)**, or call **1(319)622-5511** if outside the U.S.A. You may also contact us on the web at **www.amana.com**.

When contacting Amana, please provide the following information. Product information is on the serial plate, located on ceiling of fresh food section.

Model Number \_\_\_\_\_

'P' Number \_\_\_\_\_

Serial Number \_\_\_\_\_

Purchase Date \_\_\_\_\_

Dealer Name \_\_\_\_\_

Dealer Address \_\_\_\_\_

Dealer Phone \_\_\_\_\_

## Asure™ Extended Service Plan

Amana offers long-term service protection for this new refrigerator.

**Asure™ Extended Service Plan** is specially designed to supplement

Amana's strong warranty. This plan covers parts, labor, and travel charges.

Call **1(800)528-2682**, or contact us at **www.amana.com** for more information.

## Before Calling Service...

If something seems unusual, please check "Trouble Shooting" section, which is designed to help you solve problems before calling service.

## What if These Features are Different from Mine?

This book is intended to show the variety of features that are available in the product line. If your refrigerator does not have all the options that are shown, many of these options may be purchased by contacting the Consumer Affairs Department. See contact information on the cover of your manual.

# Important Safety Information

## Recognize Safety Symbols, Words, Labels



### DANGER

**DANGER**—Immediate hazards which **WILL** result in severe personal injury or death.



### WARNING

**WARNING**—Hazards or unsafe practices which **COULD** result in severe personal injury or death.



### CAUTION

**CAUTION**—Hazards or unsafe practices which **COULD** result in minor personal injury or product or property damage.

## What You Need to Know about Safety Instructions

Warning and Important Safety Instructions appearing in this manual are not meant to cover all possible conditions and situations that may occur. Common sense, caution, and care must be exercised when installing, maintaining, or operating refrigerator. Always contact your dealer, distributor, service agent, or manufacturer about problems or conditions you do not understand.



### WARNING

**To reduce risk of fire, electric shock, serious injury, or death when using your refrigerator, follow these basic precautions, including the following:**

1. Read all instructions before using refrigerator.
2. Observe all local codes and ordinances
3. Be sure to follow grounding instructions.
4. Check with a qualified electrician if you are not sure this appliance is properly grounded.
5. DO NOT ground to a gas line.
6. DO NOT ground to cold water pipe.
7. Refrigerator is designed to operate on a separate 103 to 126 volt, 15 amp., 60 cycle line. DO NOT modify plug on power cord. If plug does not fit electrical outlet, have proper outlet installed by a qualified electrician.
8. DO NOT use a two-prong adapter, extension cord or power strip.
9. DO NOT remove warning tag from power cord.
10. DO NOT tamper with refrigerator controls.
11. DO NOT service or replace any part of refrigerator unless specifically recommended in owner's manual or published user-repair instructions. DO NOT attempt service if instructions are not understood or if they are beyond personal skill level.
12. Always disconnect refrigerator from electrical supply before attempting any service. Disconnect power cord by grasping the plug, not the cord.
13. Install refrigerator according to Installation Instructions. All connections for water, electrical power, and grounding must comply with local codes and be made by licensed personnel when required.
14. Keep your refrigerator in good condition. Bumping or dropping refrigerator can damage unit or cause unit to malfunction or leak. If damage occurs, have refrigerator checked by qualified service technician.
15. Replace worn power cords and/or loose plugs.
16. Always read and follow manufacturer's storage and ideal environment instructions for items being stored in refrigerator.



### DANGER

**To reduce risk of injury or death, follow basic precautions, including the following:**

#### Proper Disposal of Your Refrigerator

**IMPORTANT:** Child entrapment and suffocation are not problems of the past. Junked or abandoned refrigerators are still dangerous—even if they sit out for "just a few days". If you are getting rid of your old refrigerator, please follow the instructions below to help prevent accidents.

**BEFORE YOU THROW AWAY YOUR OLD REFRIGERATOR OR FREEZER:**

- Take off the doors.
- Leave the shelves in place so children may not easily climb inside.

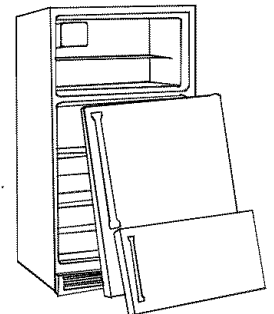

## Save These Instructions

# Installing Your Refrigerator

These instructions were provided to aid you in the installation of your unit. Amana cannot be responsible for improper installation.

## How do I measure an opening to insure proper fit?

A ½" of air space should be provided for the top and back of the unit to allow for proper air circulation. When installing your unit, measure carefully. Subflooring or floor coverings (i.e. carpet, tile, wood floors, rugs) may make your opening smaller than anticipated.

Some clearance may be gained by using the leveling procedure under *How to Level Your Refrigerator*.

**IMPORTANT:** If unit is to be installed into a recess where top of unit is completely covered, use dimensions from floor to top of hinge cap to verify proper clearance.

## How to Transport Your Unit

Follow these tips when moving the unit to final location:

- NEVER transport unit on its side. If an upright position is not possible, lay unit on its back. Allow unit to sit upright for approximately 30 minutes prior to plugging unit in to assure oil return to the compressor. Plugging unit in immediately may cause damage to internal parts.
- Use an appliance dolly when moving unit. ALWAYS truck unit from its side—NEVER from its front or back.
- Protect outside finish of unit during transport by wrapping cabinet in blankets or inserting padding between the unit and dolly.
- Secure unit to dolly firmly with straps. Thread straps through handles when possible. DO NOT overtighten. Overtightening restraints may dent or damage outside finish.

## How to Select the Best Location

Observe these points when choosing the final location for your unit:

- DO NOT install refrigerator near oven, radiator, or other heat source. If not possible, shield unit with cabinet material.
- DO NOT install where temperature falls below 55°F (13°C). Malfunction may occur at this temperature.
- Make sure floor is level. If floor is not level, shim rear wheels of unit with a piece of plywood or other shim material.
- To assure proper door closure, verify that the unit is leveled with a ¼" tilt to the back.

## How to Remove the Doors and Hinges

Some installations require door removal to get refrigerator to final location. If removal of the pullout drawer is required, see later section entitled **How to Remove and Install the Pullout Drawer**

### WARNING

To avoid electrical shock which can cause severe personal injury or death, observe the following:

- Disconnect power to refrigerator before removing doors. Connect power only after replacing doors.

### CAUTION

To avoid damage to walls and flooring, protect soft vinyl or other flooring with cardboard, rugs, or other protective material.

**1** Unplug power cord from power source.

**2** Remove toe grille and bottom bracket cover(s).

- Open freezer door as wide as possible.
- Depending on the model of your unit, you may have one or two bracket covers.

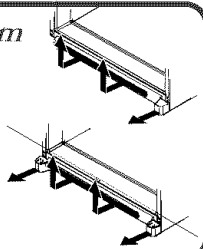

**3** Remove top hinge cover by removing Phillips screw.

- Retain screw and cover for replacement.

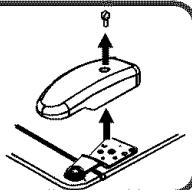

**4** Unscrew 5/16" hex head screws from top hinge to remove hinge.

- Retain all screws for later use.

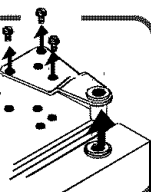

**5** Lift refrigerator door from center hinge pin.

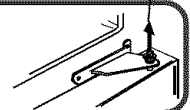

**6** Hold freezer door in place while removing center hinge pin with a 5/16" hex nut driver. Remove freezer door.

- Retain hinge pin for later use.

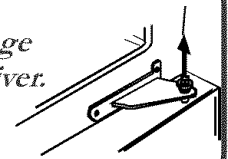

**7** Remove Phillips screws to remove center hinge.

- Retain all screws for later use.

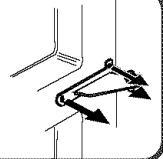

**8** Remove bottom hinge or stabilizing bracket with 3/8" hex head driver.

- Lift out bottom hinge pin (some models).
- Retain hinge pin and screws for later use.

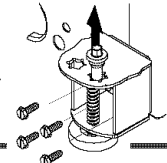

# Installing Your Refrigerator

## How to Reverse the Doors

**1** Perform all steps listed in **How to Remove the Doors and Hinges**.

**2** Transfer cabinet plugs and cabinet screws to opposite side of cabinet.

- Remove cabinet plugs with flat blade screwdriver tip wrapped in masking tape.
- Remove center mullion screws with  $\frac{5}{16}$ " hex head driver.
- For swing doors only Remove bottom mullion screws with  $\frac{3}{8}$ " hex head driver.

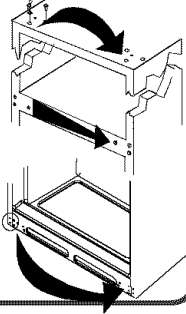

**IMPORTANT:** When working directly on doors, place doors on a nonabrasive surface protected by towels or rugs to avoid damage to door finish.

**3** Transfer door stops from bottom edge of fresh food and freezer door to opposite side of door edge.

- Use a Phillips screwdriver for removal and installation.

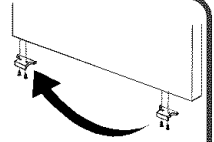

**4** See **How to Install and Remove Handles to remove and reinstall handles**.

**5** Proceed to **How to Replace the Doors and Hinges to mount doors**.

## How to Install and Remove Handles

### Installing Fresh Food Front-Mounted Handles

If installing handles for the first time, the fresh food handles can be located within the fresh food section. The handle trim will be located in the literature pack.

**1** Remove  $\frac{1}{4}$ " hex nut screws from door face with hex nut driver.

- If reversing door, remove door plugs from opposite side of door and insert in screw holes.

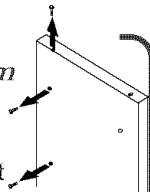

**2** Align handle holes with screw holes on door face and secure with 2 door face screws from step 1.

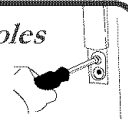

**3** Locate handle trim in literature pack and install over top and bottom of handle, as illustrated.

- Secure top handle trim with remaining screw removed in step 1.
- Snap bottom trim over bottom portion of handle.



### Removing Fresh Food Front-Mounted Handles

Removing handles may be necessary when transporting unit through tight spaces, or when reversing the door.

**1** Remove top handle trim by removing top handle screw.

- Retain trim and screw for later replacement.

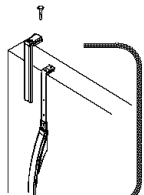

**2** Pry bottom handle trim from handle with screwdriver flat blade wrapped in masking tape.

- Retain trim for later replacement.

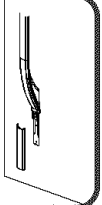

**3** Remove two remaining handle screws and remove handle.

- Retain screws for later replacement.

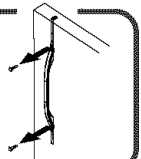

### Installing Freezer Handles

If installing handles for the first time, the freezer handles can be located within the freezer section.

Install handle by fastening with screws removed from edge of door.

- If reversing freezer door, remove door plugs from top edge of door and insert into screw holes.

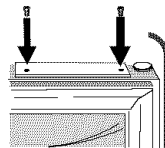

### Removing Freezer Handles

Removing handles may be necessary when transporting unit through tight spaces, or when reversing the door.

Remove handle screws with Phillips screwdriver.

- Retain screws for later replacement.

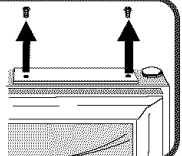

# Installing Your Refrigerator

## How to Install and Remove Handles continued

### Installing Fresh Food Side-Mounted Handles

If installing handles for the first time, the fresh food handles can be located on the back of the refrigerator.

Install handle by fastening with T-15 Torx® screws removed from edge of door.

**NOTE:** If reversing door, remove door plugs from opposite side of door and insert in screw holes.

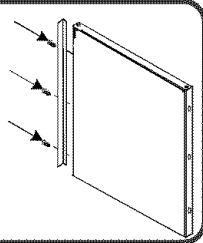

### Removing Fresh Food Side-Mounted Handles

Removing handles may be necessary when transporting unit through tight spaces, or when reversing the door.

Remove handle by removing three T-15 Torx® screws from side of door.

- Retain screws for later replacement.

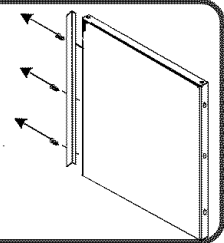

### Installing Freezer Handles

If installing handles for the first time, the freezer handles can be located on the back of the refrigerator.

Install handle by fastening with T-15 Torx® screws removed from edge of door.

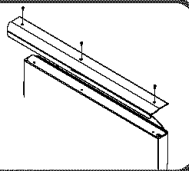

### Removing Freezer Handles

Removing handles may be necessary when transporting unit through tight spaces.

Remove handle by removing three T-15 Torx® screws from handle.

- Retain screws for later replacement.

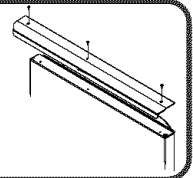

\* Torx® is a registered trademark of Textron Inc.

## Installing and Removing Stainless Steel Front-Mounted Handles

### **WARNING**

To avoid risk of serious personal injury from sharp edges, do not remove front-mounted stainless steel handles from unit.

## How to Replace the Doors and Hinges

### 1 Install hinge assemblies.

- Install top hinge *loosely* with  $\frac{5}{16}$ " hex head screws.
- Install center hinge with Phillips screws.
- Install bottom hinge with  $\frac{3}{8}$ " hex head screws.

### 2 Insert bottom hinge pin (some models).

- Locate bottom hinge hole closest to outside edge of cabinet, and insert bottom hinge pin. Replace any door shims, if present.

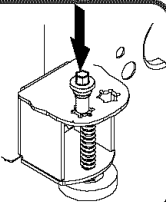

### 3 Place hinge side of freezer door on bottom hinge pin and hold freezer door upright while installing center hinge pin with $\frac{5}{16}$ " hex head driver.

- Replace any applicable door shims.
- Make sure the hinge pin is installed tight.

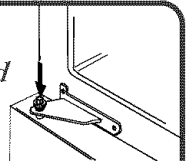

### 4 Place hinge side of refrigerator door on center hinge pin.

### 5 While holding refrigerator door upright, tighten down top hinge with $\frac{5}{16}$ " hex head driver and replace hinge cover.

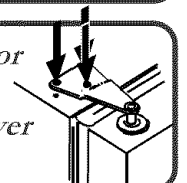

# Installing Your Refrigerator

## How to Remove and Install the Pullout Drawer

### **WARNING**

To avoid electrical shock which can cause severe personal injury or death, disconnect power to refrigerator before removing doors. After replacing doors, connect power.

### **CAUTION**

To avoid possible injury, product, or property damage, you will need two people to perform the following instructions.

#### Removing Pullout Drawer

- 1** Pull drawer open to full extension. Remove Phillips screw from each side of rail system.

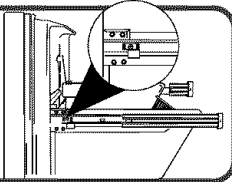

- 2** Remove lower basket by lifting basket from rail system.

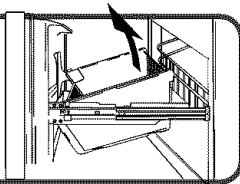

- 3** Pull upper basket out to full extension, and lift out to remove.

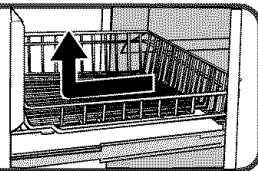

- 4** Lift top of door to unhook door supports from rail system. Lift door out to remove.

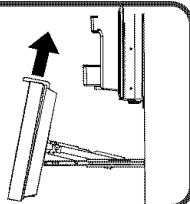

#### Installing Pullout Drawer

- 1** Pull both rails out to full extension.

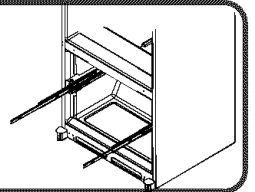

- 2** Hook door supports into rail tabs, as illustrated, and lower door into final position.

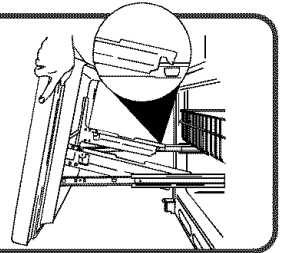

- 3** With drawer pulled out to full extension, insert lower basket by aligning tabs on both side of lower basket with notches in rail assembly.

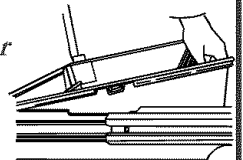

- 4** Slide upper basket into unit. Make sure that rear of basket hooks behind rail catch.

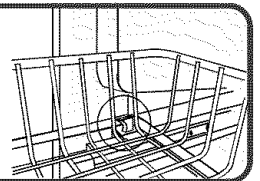

# Installing Your Refrigerator

## How to Connect the Water Supply

### **WARNING**

To reduce the risk of injury or death, follow basic precautions, including the following:

- Read all instructions before installing device.
- DO NOT attempt installation if instructions are not understood or if they are beyond personal skill level.
- Observe all local codes and ordinances.
- DO NOT service device unless specifically recommended in owner's manual or published user-repair instructions.
- Disconnect power to unit prior to installing device.

### **CAUTION**

To avoid property damage or possible injury, follow basic precautions, including the following:

- Consult a plumber to connect copper tubing to household plumbing to assure compliance with local codes and ordinances.
- Confirm water pressure to water valve is between 20 and 100 pounds per square inch. If water filter is installed, water pressure to water valve must be a minimum of 35 pounds per square inch.
- **DO NOT use a self-piercing, or  $3/16$ " saddle valve!** Both reduce water flow, become clogged with time, and may cause leaks if repair is attempted.
- Tighten nuts by hand to prevent cross threading. Finish tightening nuts with pliers and wrenches. Do not overtighten.
- Wait 24 hours before placing unit into final position to check and correct any water leaks.

#### Materials Needed

- $1/4$ " outer diameter flexible copper tubing

**NOTE:** Add 8' to tubing length needed to reach water supply for creation of service loop.

- Shut-off valve (requires a  $1/4$ " hole to be drilled into water supply before valve attachment)

- Adjustable wrench
- $1/4$ " hex nut driver

- 1** Create service loop with tubing using care to avoid kinks in tubing.

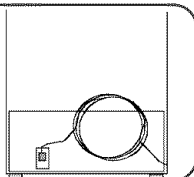

- 2** Remove plastic cap (A) from water valve inlet port (B).

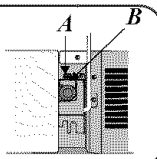

- 3** Place brass nut (D) and sleeve (E) on copper tube end as illustrated.

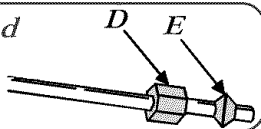

- 4** Place end of copper tubing into water valve inlet port. Shape tubing slightly—DO NOT KINK—so that tubing feeds straight into inlet port.

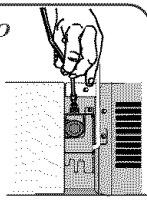

- 5** Slide brass nut over sleeve and screw nut into inlet port. Tighten nut with wrench.

**IMPORTANT:** DO NOT overtighten. Cross threading may occur.

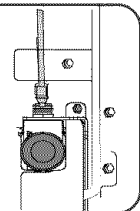

- 6** Pull on tubing to confirm connection is secure. Connect tubing to frame with water tubing clamp (F) and turn on water supply. Check for leaks and correct, if present.

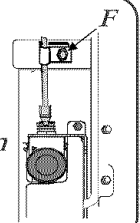

- 7** Monitor water connection for 24 hours. Correct leaks, if necessary.

# Installing Your Refrigerator

## How to Level Your Refrigerator

If your refrigerator requires an ice maker water supply connection, proceed to **How to connect the water supply** section before leveling your refrigerator.

### CAUTION

To protect personal property or unit from damage, observe the following:

- Protect soft vinyl or other flooring with cardboard, rugs, or other protective material.
- Do not use power tools when performing leveling procedure.

*Materials Needed* •  $\frac{3}{8}$ " hex head driver • Level

**1** Move refrigerator to final location and plug in power cord.

**2** Remove toe grille and bottom cover(s)

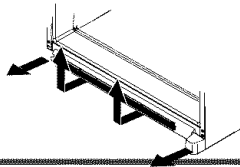

**3** Turn left and right adjustment screws (A) to raise or lower front of refrigerator.

- Make sure refrigerator cabinet is level from side to side by adjusting left and right roller adjustment screws.
- Turn stabilizing leg clockwise until firmly against floor.

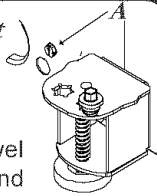

**For Pullout Drawer Models:** After completing the above listed steps, turn roller adjustment screws (A) 2 to 3 times counterclockwise, so that full weight of unit rests on stabilizing legs.

**4** Using a level, make sure front of refrigerator is  $\frac{1}{4}$ " (6 mm) or  $\frac{1}{2}$  bubble higher than back of refrigerator.

- See leveling step 3 for assistance.

**5** Replace toe grille and bracket cover(s). See markings on inside of toe grille to insure proper placement.

- Snap bottom portion into place first. Press down on top part of grille until top portion snaps into place.

## How to Adjust the Temperature Controls

This refrigerator is designed to operate at a household temperature of 55° to 110°F (13° to 43° C). For initial temperature setting, follow all five steps listed below. If doing a simple temperature modification for an operational unit, only steps 3 through 5 are required.

**1** Locate refrigerator controls at the top of fresh food compartment and freezer controls at top of freezer section. Set both controls to 4. **IMPORTANT:** Neither section will cool if freezer control is set to Off.

**2** Allow 24 hours for temperatures to stabilize.

**3** Check to see if freezer temperature is 0° to 2° F (-17° to -16° C).

- Turn control to next highest number if too warm.
- Turn control to next lowest number if too cold. Allow 5 to 8 hours for adjustments to take effect.

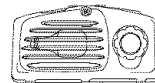

**4** Check to see that fresh food section is 38° to 40° F (3° to 4° C).

- Turn control to next highest number if too warm.
- Turn control to next lowest number if too cold.
- Allow 5 to 8 hours for adjustments to take effect.



**5** Repeat steps 3 & 4, as necessary.

How do I perform a temperature test?  
Materials needed



- 2 thermometers measuring -5° to 50°F (-21° to 10°C)
- 2 drinking glasses

**For Freezer**

- Place thermometer in glass of vegetable oil in middle of freezer and continue with step 3 of *Temperature Adjustment* section.

**IMPORTANT:** Always start temperature adjustments with freezer section.

**For Refrigerator**

- Place thermometer in glass of water in middle of unit and continue with step 3 of *Temperature Adjustment* section.

# Fresh Food Features

## Interior Shelves



### CAUTION

To avoid personal injury or property damage, observe the following:

- Confirm shelf is secure before placing items on shelf.
- Handle tempered glass shelves carefully. Shelves may break suddenly if nicked, scratched, or exposed to sudden temperature change.

### Full-Width Shelf

- To remove shelves, unhook shelf from rear ladder assembly and pull out.
- To install shelves, insert shelf hooks into rear ladder assembly and lower into place.

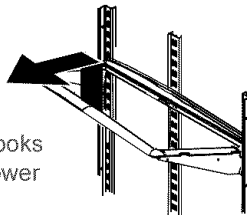

### Spillsaver™ *some models*

Spillsaver™ stationary shelves hold simple spills for easier cleaning.

- To remove shelves, lift up and out.
- To install shelves, reverse above procedure.

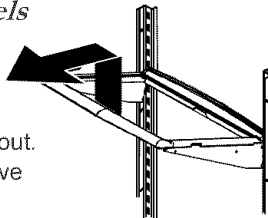

### Spillsaver™ EasyGlide™ *some models*

Spillsaver™ EasyGlide™ shelves feature the convenience of easy cleaning with a pullout design to reach items in the back. For ease of cleaning, glass shelf may be removed by pulling to full extension and lifting out of frame.

- To remove shelf and frame, see instructions for Spillsaver™ stationary shelves.

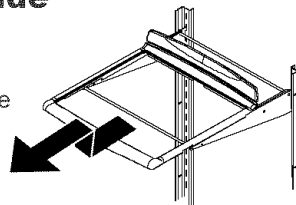

### Rear Shelf Extensions *some models*

Rear shelf extensions help prevent articles from falling off the back of the shelf.

To remove and install shelf extension:

- To remove, pull extension straight up from rear of shelf.
- To install, insert posts of the shelf extension into holes in the shelf frame.

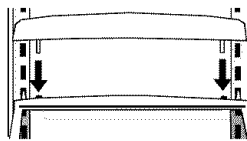

## Door Storage

### Dairy Center

The dairy center provides convenient storage for items such as butter, yogurt, cheese, etc. This compartment is an adjustable feature located in the door. It can be moved to several different locations to accommodate storage needs.

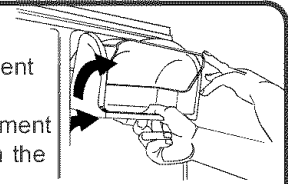

- To remove, open dairy door, pull upward and tilt out.
- To install, reverse above procedure.

### Door Buckets

Door buckets adjust to meet individual storage needs.

- To remove, slide bucket up and pull straight out.
- To install, reverse above procedure.

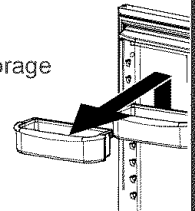

### Door Retainer

Door retainers remove for easy cleaning.

- To remove, slide retainer up and pull straight out.
- To install, reverse above procedure.

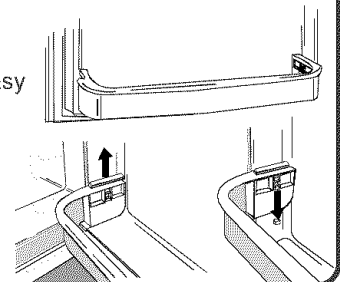

## Accessories

### Grip Pads *some models*

The Grip Pads prevents objects from sliding in the door bucket. Grip Pads are removable and are top-rack dishwasher safe for easy cleaning.

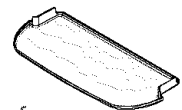

### Wine Trivet/Can Rack *some models*

The Wine Trivet/Can Rack accessory fits in the bottom of most drawer assemblies.

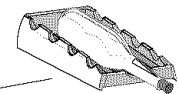

Beer bottles can be laid cross-wise, or a single bottle may be laid in the center depression. Cans may also be stored, as illustrated.

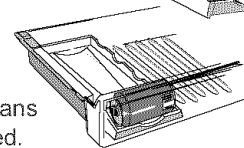

### Pantry Divider *some models*

The pantry divider is used to organize the Chef's Pantry™ into sections, and features a collapsible joint on the front edge to ensure a snug fit.



**NOTE:** For easiest execution, remove pantry. If removal is not possible, pull drawer open to its fullest extension.

To remove and replace divider:

- To remove, unhook divider from rear wall of pantry, and pull out.
- To install, hook back of divider over rear wall of pantry and press down until front joint snaps into place.



# Fresh Food Features

## Climate-Controlled Drawers

### Humidity-Controlled Crisper Drawers

The crisper drawer keeps produce fresh longer by providing an environment with adjustable humidity.

#### Controls

The crisper controls regulate the amount of humidity in the crisper drawer. Use the *low* setting for produce with outer skins. Use the *high* setting for leafy produce.

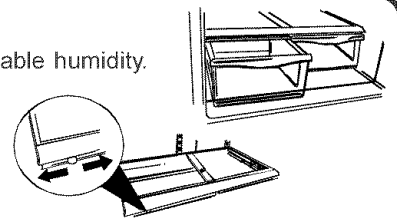

### Temperature-Controlled Drawer

#### Chef's Pantry™

The Chef's Pantry™ system provides a drawer with a variable temperature control that keeps the compartment up to 5°F (3°C) colder than refrigerator temperature. This drawer can be used for large party trays, deli items, or beverages.

#### Control

The Chef's Pantry™ control regulates the air temperature in the drawer. Set control level to *cold* to provide normal refrigerator temperature. Use the *coldest* setting for meats or other deli items.

**NOTE:** Cold air directed to the Chef's Pantry™ can decrease refrigerator temperature. Refrigerator control may need to be adjusted.

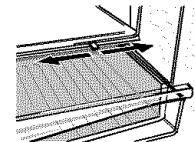
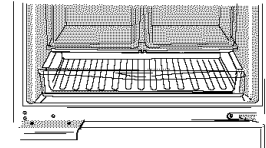

## Storage Drawers

### Snack Drawer

This drawer can be used for storage of food items or extra produce.

### Beverage Organizer™ some models

The Beverage Organizer™ slides out from underneath the Spillsaver™ stationary shelf. The Beverage Organizer™ holds up to twelve 12-ounce beverage cans.

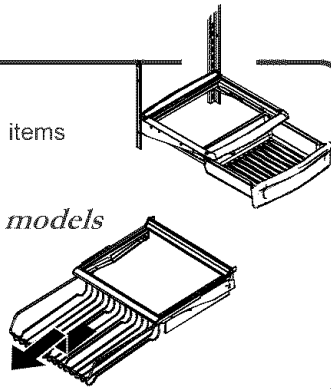

### What if I can't open my door wide enough to remove the drawers?

- Remove drawer furthest from hinge side of cabinet.
- Remove glass as previously instructed.
- Lift center divider from frame. Slide existing drawer away from hinge side of cabinet and remove.

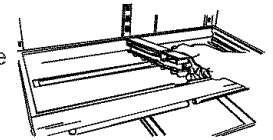

#### To remove and install drawers:

- To remove drawer, pull drawer out to full extension. Tilt up front of drawer and pull straight out.
- To install, insert drawer into frame rails and push back into place.

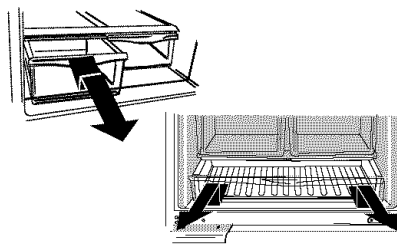

#### To remove and install glass and frame:

- Remove drawers as instructed above.
- Place hand beneath frame to push up glass from underneath. Lift glass out.
- Lift frame from refrigerator liner rails.
- To install, repeat above instructions in reverse order.

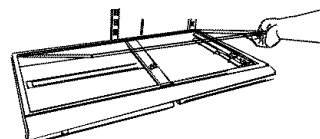

### What can I do to prolong the life of my produce?

Please observe the following rules when storing produce in humidity-controlled crisper drawers:

- DO NOT wash produce before placing in crispers. Any additional moisture added to the drawers may cause produce to prematurely spoil.
- DO NOT line crispers with paper towels. Towels will retain moisture.
- Follow control instructions carefully. Not setting controls correctly may damage produce.

See chart below for assistance with controls:

- LOW**
- cauliflower
  - apples
  - corn
  - oranges
  - zucchini
  - grapes
  - cucumbers

- HIGH**
- lettuce
  - asparagus
  - spinach
  - cabbage
  - celery
  - broccoli
  - fresh sprouts
  - fresh herbs

# Freezer Features

## Primary Features

### Automatic Ice Maker *(some models)*

#### Using Ice Maker for the First Time

- Confirm ice bin is in place and ice maker arm is down.
- After freezer section reaches between 0° to 2°F (-18° to -17° C), ice maker fills with water and begins operating.
- Allow approximately 24 hours after installation to receive first harvest of ice.
- Discard ice created within first 12 hours of operation to verify system is flushed of impurities.

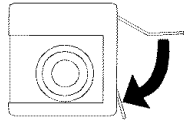

#### Operating Instructions

- Confirm ice bin is in place and ice maker arm is down.
- After freezer section reaches 0° to 2°F (-18° to -17° C), ice maker fills with water and begins operating. You will have a complete harvest of ice approximately every 3 hours.
- Stop ice production by raising ice maker arm until click is heard.
- Ice maker will remain in the off position until arm is pushed down.

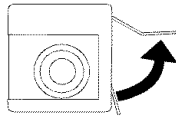

## CAUTION

To avoid property damage, observe the following:

- Do not force ice maker arm down or up.
- Do not place or store anything in ice storage bin.

## Drawers

### Wire Basket

#### To remove and install basket:

- To remove basket, pull basket out to full extension. Tilt up front of basket and pull straight out.
- To install, insert basket into refrigerator liner rails and push back into place.

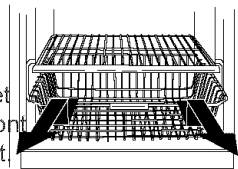

### Pullout Drawer Baskets *(some models)*

(Door assembly of drawer removed from illustration for visual clarity)

#### To remove and replace top basket:

- Remove basket by pulling basket out to its full extension and lift out.
- Replace basket by sliding into upper molded railing.

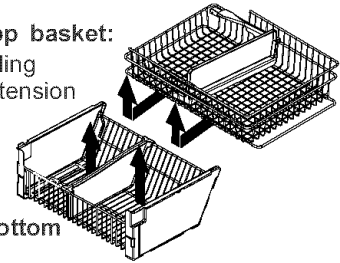

#### To remove and replace bottom basket:

- Remove basket by lifting basket from rail guides.
- Replace basket by placing into rail guides.

## DANGER

To prevent accidental child entrapment or suffocation risk, DO NOT remove the divider in the top freezer basket.

## Shelves

### Ice Service Rack

#### To install and remove rack:

- To install, slide L-shaped groove of shelf down over back wall screw. Push rack back until screw is stopped in L-shaped groove (1). Slide front portion of shelf over front wall screw (2).
- To remove, perform above steps in reverse order.

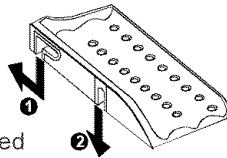

### Fixed Freezer Shelf

#### To remove and install shelves:

- Remove shelf by pulling out to full extension. Tilt up front of shelf and pull straight out.
- To install, insert shelf into refrigerator liner rails and push to back of compartment.

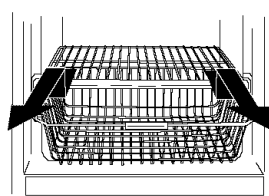

### Slide-Out Freezer Shelf

#### To remove and install shelves:

- Remove shelf by pulling out to full extension. Tilt up front of shelf and pull straight out.
- To install, insert shelf into refrigerator liner rails and push to back of compartment.

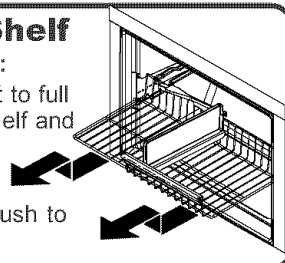

## Door Storage

### Fixed Door Shelf

The fixed door shelf provides convenient storage for frozen food items in freezer door.

#### To remove and install door shelf:

- To remove shelf, lift assembly from side liner tabs and pull out.
- To install, fit ends of shelf assembly on liner tabs and slide down.

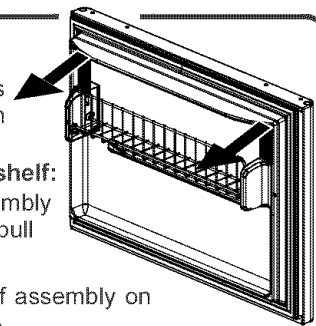

### Tilt-Out Bin *(some models)*

The tilt-out bin (A) provides convenient storage for frozen food items in freezer door and tilts forward for easy access of those items.

#### To remove and install door shelf:

- See above instructions listed for Fixed Door Shelf.

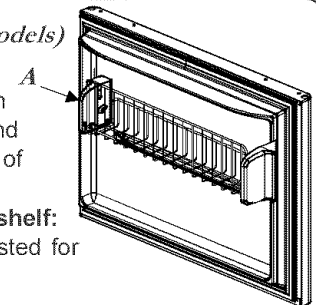

## Accessories

### **Ice Cube Tray** *(some models)*

The ice cube tray provides an area to freeze cubes for manual dispensing of ice.

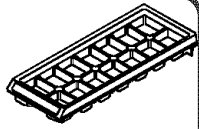

To release ice cubes from tray, hold tray upside down over a storage container and twist both ends of tray until cubes release.

### **Lower Basket Divider**

*(some models)*

The lower basket divider allows the option to organize the basket area into sections.

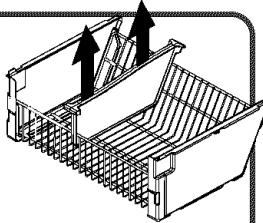

**To remove and replace divider:**

- To remove, pull divider straight up.
- To install, hook top corners of divider over top horizontal basket rungs.

# Hints and Care

## What cleaners does Amana recommend for my stainless steel product?

Amana has a cleaner available for purchase (Part # 31960801) through our Consumer Affairs division. For this, or a list of other recommended cleaning products, please contact us at Amana Consumer Affairs using the information on the cover of your Owner's Manual.

## How to Clean Your Unit



### WARNING

To avoid electrical shock which can cause severe personal injury or death, disconnect power to refrigerator before cleaning. After cleaning, connect power.

### CAUTION

To avoid personal injury or property damage:

- Read and follow manufacturer's directions for all cleaning products.
- Do not place buckets, shelves, or accessories in dishwasher. Cracking or warping of accessories may result

## How do I remove an odor from my refrigerator?

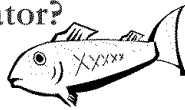

1. Remove all food.
2. Disconnect refrigerator.
3. Clean the following items using the appropriate instructions in *How to Clean Your Unit* :
  - Walls, floor, and ceiling of cabinet interior.
  - Drawers, shelves, and gaskets according to the instructions in this section.
4. Pay special attention to clean all crevices by completing the following steps:
  - Dilute mild detergent and brush solution into crevices using a plastic bristle brush.
  - Let stand for 5 minutes.
  - Rinse surfaces with warm water. Dry surfaces with a soft, clean cloth.
5. Wash and dry all bottles, containers, and jars. Discard spoiled or expired items.
6. Wrap or store odor-causing foods in tightly-sealed containers to prevent reoccurring odors.
7. Connect power to refrigerator and return food to unit.
8. After 24 hours, check if odor has been eliminated.

### If odor is still present...

1. Remove drawers and place on top shelf of refrigerator.
2. Pack refrigerator and freezer sections—including doors—with crumpled sheets of black and white newspaper.
3. Place charcoal briquettes randomly on crumpled newspaper in both freezer and refrigerator compartments.
4. Close doors and let stand 24–48 hours.
5. Repeat steps 5 through 7.

AREA	DO NOT USE	DO...
<b>Textured Doors and Exterior</b> <b>Cabinet Interior</b>	<ul style="list-style-type: none"> <li>• Abrasive or harsh cleaners</li> <li>• Ammonia</li> <li>• Chlorine bleach</li> <li>• Concentrated detergents or solvents</li> <li>• Metal or plastic-textured scouring pads</li> </ul>	<ul style="list-style-type: none"> <li>• Use 4 tablespoons (60 milliliters) of baking soda dissolved in 1 quart (1 liter) warm soapy water.</li> <li>• Rinse surfaces with clean warm water and dry immediately to avoid water spots</li> </ul>
<b>Stainless Steel Doors and Exterior</b> <b>IMPORTANT:</b> <i>Damage to stainless steel finish due to improper use of cleaning products or non-recommended products is not covered under any warranty</i>	<ul style="list-style-type: none"> <li>• Abrasive or harsh cleaners</li> <li>• Ammonia</li> <li>• Chlorine bleach</li> <li>• Concentrated detergents or solvents</li> <li>• Metal or plastic-textured scouring pads</li> <li>• Vinegar-based product</li> <li>• Citrus-based cleaners</li> </ul>	<ul style="list-style-type: none"> <li>• Use warm, soapy water and a soft, clean cloth or sponge.</li> <li>• Rinse surfaces with clean warm water and dry immediately to avoid water spots</li> </ul>
<b>Door Gaskets</b>	<ul style="list-style-type: none"> <li>• Abrasive or harsh cleaners</li> <li>• Metal or plastic-textured scouring pads</li> </ul>	
<b>Condenser Coil</b> <i>Remove toe grille to access</i>	N/A	<ul style="list-style-type: none"> <li>• Use a vacuum cleaner hose nozzle</li> </ul>
<b>Condenser Fan Outlet Grille</b> <i>See back of refrigerator</i>		<ul style="list-style-type: none"> <li>• Use a vacuum cleaner hose nozzle with brush attachment.</li> </ul>
<b>Accessories</b> <i>Shelves, buckets, drawers, etc</i>	<ul style="list-style-type: none"> <li>• A Dishwasher</li> </ul>	<ul style="list-style-type: none"> <li>• Follow removal and installation instructions from appropriate feature section.</li> <li>• Allow items to adjust to room temperature.</li> <li>• Dilute mild detergent and use a soft clean cloth or sponge for cleaning.</li> <li>• Use a plastic bristle brush to get into crevices</li> <li>• Rinse surfaces with clean warm water.</li> <li>• Dry glass and clear items immediately to avoid spots.</li> </ul>

## How to Remove and Replace Light Bulbs

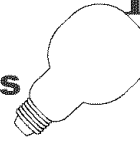

### WARNING

To avoid electrical shock which can cause severe personal injury or death, disconnect power to refrigerator before replacing light bulb. After replacing light bulb, connect power.

### CAUTION

To avoid personal injury or property damage, observe the following:

- Allow light bulb to cool.
- Wear gloves when replacing light bulb.

### Fresh food section

1. Remove screw from light shield. Retain for replacement.
1. Slide shield toward back of compartment to release from light assembly.
2. Remove light bulbs.
3. Replace with appliance bulbs **no greater than 40 watts**.
4. Replace light bulb cover by inserting tabs on light shield into liner holes on each side of light assembly. Slide shield toward front of unit until it locks into place. **DO NOT** force shield beyond locking point. Doing so may damage light shield.
5. Replace screw removed in step 1.

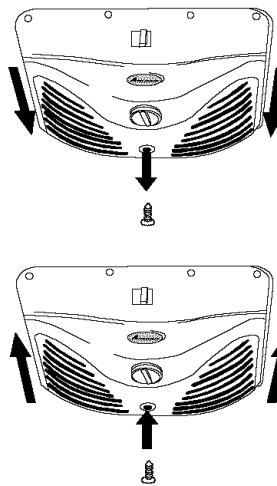

### Freezer section

1. Pinch rear tabs (**A**) on light cover and pull straight out.
2. Remove light bulb.
3. Replace bulb with appliance bulb **no greater than 40 watts**.
4. Insert top tabs (**B**) of light cover into refrigerator liner and snap back portion over light assembly.

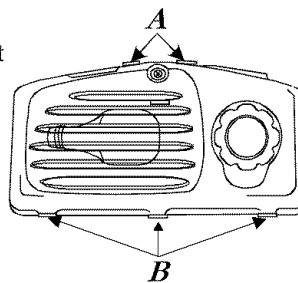

### How to Get the Most Out of Your Energy Dollar

- When placing refrigerator into final position, allow for 1" clearance around the top and sides of unit to supply ample ventilation for optimum energy efficiency.
- Avoid overcrowding refrigerator shelves. This reduces effectivity of air circulation around food and causes refrigerator to run longer.
- Avoid adding too much warm food to unit at one time. This overloads compartments and slows rate of cooling.
- Do not use aluminum foil, wax paper, or paper toweling as shelf liners. This decreases air flow and causes unit to run less efficiently.
- A freezer that is  $\frac{2}{3}$  full runs most efficiently.
- Locate refrigerator in coolest part of room. Avoid areas of direct sunlight, or near heating ducts, registers, or other heat producing appliances. If this is not possible, isolate exterior by using a section of cabinet or an added layer of insulation.
- Refer to owner's manual section on temperature controls for recommended control settings
- Clean door gaskets every three months according to Owner's Manual cleaning instructions. This will assure that door seals properly and unit runs efficiently.
- Take time to organize items in refrigerator to reduce time that door is open.
- Be sure your doors are closing securely by leveling unit as instructed in your Owner's Manual.
- Clean condenser coils of as indicated in the owner's manual every 3 months. This will increase energy efficiency and cooling performance.

# Trouble Shooting

## NOISE

Today's refrigerators have new features and are more energy efficient. Foam insulation is very energy efficient and has excellent insulating capabilities, however, foam insulation is not as sound absorbent. As a result, certain sounds may be unfamiliar. In time, these sounds will become familiar. Please refer to this information before calling service.

TOPIC	POSSIBLE CAUSE	SOLUTION
Clicking	Freezer control <b>(A)</b> clicks when starting or stopping compressor.	Normal operation
	Defrost timer <b>(B)</b> sounds like an electric clock and snaps in and out of defrost cycle.	Normal operation
Air rushing or whirring	Freezer fan <b>(C)</b> and condenser fan <b>(D)</b> make this noise while operating.	Normal operation
Gurgling or boiling sound	Evaporator <b>(E)</b> and heat exchanger <b>(F)</b> refrigerant makes this noise when flowing.	Normal operation
Thumping	Ice cubes from ice maker (some models) drop into ice bucket <b>(G)</b> .	Normal operation
Vibrating noise	Compressor <b>(H)</b> makes a pulsating sound while running.	Normal operation
	Refrigerator is not level.	See <i>Installation Instructions</i> for details on how to level your unit.
Buzzing	Ice maker water valve <b>(I)</b> hookup (some models) buzzes when ice maker fills with water.	Normal operation
Humming	Ice maker <b>(J)</b> is in the 'on' position without water connection.	Stop sound by raising ice maker arm to 'off' position. See <i>Automatic Ice Maker</i> section in your owner's manual for details.
	Compressor <b>(H)</b> can make a high pitched hum while operating.	Normal operation
Hissing or popping	Defrost heater <b>(K)</b> hisses, sizzles, or pops when operational.	Normal operation

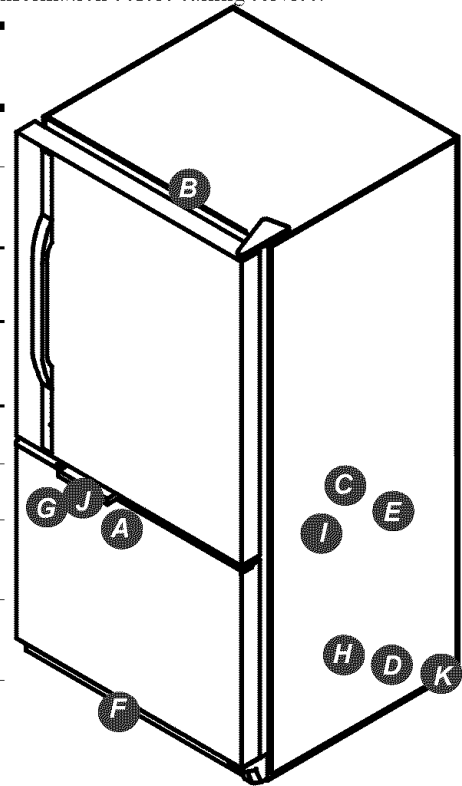

## OPERATION

Freezer control and lights are on, but compressor is not operating.	Refrigerator is in defrost mode.	Normal operation Wait 40 minutes to see if refrigerator restarts.
Crisper drawer temperature is too warm	Control settings are too low.	See section on Crisper drawer to adjust controls.
	Freezer controls are set too low.	See controls section in owner's manual on how to adjust your controls.
	Drawer is improperly positioned.	See section on Crisper drawer to verify drawer positioning.
Refrigerator does not operate	Refrigerator is not plugged in.	Plug in unit.
	Freezer control is not on.	See section on controls in your owner's manual.
	Fuse is blown, or circuit breaker needs to be reset.	Replace any blown fuses. Check circuit breaker and reset if necessary.
	Power outage has occurred	Call local power company listing to report outage.
Refrigerator still won't operate	Unit is malfunctioning.	Unplug refrigerator and transfer food to another unit. If another unit is not available, place dry ice in freezer section to preserve food. Warranty does not cover food loss. Contact service for assistance.
Food temperature is too cold	Condenser coils are dirty.	Clean according to cleaning instructions in your owner's manual.
	Refrigerator or freezer controls are set too high.	See controls section in owner's manual on how to adjust your controls.

# Trouble Shooting

## OPERATION

TOPIC	POSSIBLE CAUSE	SOLUTION
<b>Food temperature appears too warm</b>	Door is not closing properly.	Refrigerator is not level. See <i>How to Level Your Refrigerator</i> for details on how to level your unit. Check gaskets for proper seal. Clean, if necessary, according to cleaning instructions in owner's manual. Check for internal obstructions that are keeping door from closing properly (i.e. improperly closed drawers, ice buckets, oversized or improperly stored containers or foodstuffs, etc.).
	Controls need to be adjusted.	See the controls section in your for assistance in how to adjust your controls.
	Condenser coils are dirty.	Clean according to cleaning instructions in your owner's manual.
	Rear air grille is blocked.	Check the positioning of food items in refrigerator to make sure grille is not blocked. Rear air grilles are located under crisper drawers.
	Door has been opened frequently, or has been opened for long periods of time.	Reduce time door is open. Organize food items efficiently to assure door is open for as short a time as possible. Allow interior environment to adjust for period the door has been open.
	Food has recently been added.	Allow time for recently-added food to reach refrigerator or freezer temperature.
<b>Refrigerator has an odor</b>	Compartment is dirty or has odor-causing food.	Refer to <i>Hints and Care</i> in this owner's manual for odor removal instructions.
<b>Water droplets form on outside of refrigerator</b>	Check gaskets for proper seal.	Clean, if necessary, according to cleaning instructions in owner's manual.
	Humidity levels are high.	Normal during times of high humidity.
	Controls require adjustment	See the controls section in your Owner's Manual for assistance in how to adjust your controls.
<b>Water droplets form on inside of refrigerator</b>	Humidity levels are high or door has been opened frequently.	See the controls section in your Owner's Manual for assistance in how to adjust your controls.
	Check gaskets for proper seal.	Reduce time door is open. Organize food items efficiently to assure door is open for as short a time as possible. Clean, if necessary, according to cleaning instructions in owner's manual.
<b>Refrigerator or ice maker make unfamiliar sounds or seems too loud</b>	Normal operation	Refer to noise section of troubleshooting guide in owner's manual.
<b>Crisper drawers do not close freely</b>	Contents of drawer, or positioning of items in the surrounding compartment could be obstructing drawer	Reposition food items and containers to avoid interference with the drawers.
	Drawer is not in proper position	See section Crisper drawer section for proper placement.
	Refrigerator is not level.	See <i>How to Level Your Refrigerator</i> for details on how to level your unit.
	Drawer channels are dirty or need treatment.	Clean drawer channels with warm, soapy water. Rinse and dry thoroughly. Apply a thin layer of petroleum jelly to drawer channels.
<b>Refrigerator runs too frequently</b>	Doors have been opened frequently or have been opened for long periods of time.	Reduce time door is open. Organize food items efficiently to assure door is open for as short a time as possible. Allow interior environment to adjust for period the door has been open.
	Humidity or heat in surrounding area is high.	Normal operation
	Food has recently been added.	Allow time for recently-added food to reach refrigerator or freezer temperature.
	Unit is exposed to heat by environment or by appliances nearby.	Evaluate your unit's environment. Unit may need to be moved to run more efficiently.
	Condenser coils are dirty.	Clean according to cleaning instructions in your owner's manual.

# Trouble Shooting

## OPERATION (continued)

TOPIC	POSSIBLE CAUSE	SOLUTION
Refrigerator runs too frequently (continued)	Controls need to be adjusted.	See controls section in your Owner's Manual for assistance in how to adjust your controls.
	Door is not closing properly.	Refrigerator is not level. See <i>How to Level Your Refrigerator</i> for details on how to level your unit.
		Check gaskets for proper seal. Clean, if necessary, according to cleaning instructions in owner's manual.
		Check for internal obstructions that are keeping door from closing properly (i.e. improperly closed drawers, ice buckets, oversized or improperly stored containers or foodstuffs, etc.).

## ICE

Unit is leaking water	Plastic tubing was used to complete water connection.	Amana recommends using copper tubing for installation. Plastic is less durable and can cause leakage. <b>Amana is not responsible for property damage due to improper installation or water connection.</b>
Ice forms in inlet tube to ice maker	Improper water valve was installed.	Check water connection procedure in your <i>Installation Instructions</i> . Self-piercing and $\frac{3}{16}$ " saddle valves cause low water pressure and may clog the line over time. <b>Amana is not responsible for property damage due to improper installation or water connection.</b>
	Water pressure is low.	Water pressure must be between 20 to 100 pounds per square inch to function properly. A minimum pressure of 35 pounds per square inch is recommended for units with water filters.
Water flow is slower than normal	Freezer temperature is too high.	See the controls section in your owner's manual for assistance on how to adjust your controls. Freezer is recommended to be between 0 to 2°F (-18 to -17°C).
	Water pressure is low.	Water pressure must be between 20 to 100 pounds per square inch to function properly. A minimum pressure of 35 pounds per square inch is recommended for units with water filters.
	Improper water valve was installed.	Check water connection procedure in your <i>Installation Instructions</i> . Self-piercing and $\frac{3}{16}$ " saddle valves cause low water pressure and may clog the line over time. <b>Amana is not responsible for property damage due to improper installation or water connection.</b>

# Amana Refrigerator Warranty

## First Year

Amana will replace, free of charge, any part which is defective due to workmanship or materials.

## Second through Fifth Year

Amana will replace free of charge, any sealed system component (compressor, condenser, evaporator, drier and interconnecting tubing) and repair any food compartment liner (exclusive of door liner) which is defective due to workmanship or materials.

## Warranty Limitations

- Begins at date of original purchase.
- Excludes original and replacement water or air filter cartridges (if equipped with the filtration system). Original and replacement cartridges are warranted for 30 days, parts only, against defects of material or workmanship.
- Service must be performed by an authorized Amana technician.
- Damage due to shipping and handling is not covered by this warranty.

## Warranty Is Void If

### Repairs resulting from the following:

- Serial plate is defaced.
- Product is used on a commercial, rental, or leased basis.
- Product has defect or damage due to product accident, alteration, connection to an improper electrical supply, fire, flood, lightning, or other conditions beyond the control of Amana.
- Product is improperly installed or used.

## Owner's Responsibility

- Provide proof of purchase (sales receipt).
- Provide normal care and maintenance. Replace owner replaceable items where directions appear in Owner's Manual.
- Make product reasonably accessible for service.
- Pay premium service costs for service outside technician's normal business hours.
- Pay for service calls related to product installation and usage.

### Amana Appliances Factory Service

1-800-628-5782 inside USA

### For more information,

### Amana Appliances Consumer Services

Amana Appliances

2800 220th Trail

Amana, Iowa 52204

1-800-843-0304 inside USA

1-866-587-2002 au Canada

[www.amana.com](http://www.amana.com)

## IN NO EVENT SHALL AMANA BE LIABLE FOR INCIDENTAL OR CONSEQUENTIAL DAMAGES.

This warranty gives you specific legal rights, and you may have others which vary from state to state. For example, some states do not allow the exclusion or limitation of incidental or consequential damages, so this exclusion may not apply to you.

