



DRAPER[®]

230V 330mm

PLANER THICKNESSER

89156

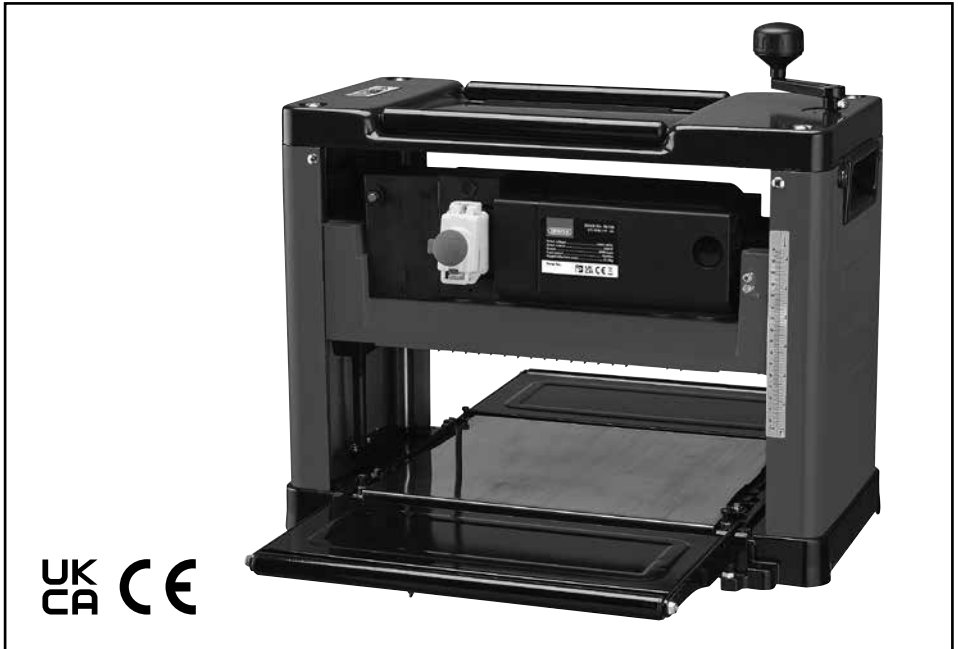

These instructions accompanying the product are the original instructions. This document is part of the product, keep it for the life of the product passing it on to any subsequent holder of the product. Read all these instructions before assembling, operating or maintaining this product.

This manual has been compiled by Draper Tools describing the purpose for which the product has been designed, and contains all the necessary information to ensure its correct and safe use. By following all the general safety instructions contained in this manual, it will ensure both product and operator safety, together with longer life of the product itself.

All photographs and drawings in this manual are supplied by Draper Tools to help illustrate the operation of the product.

Whilst every effort has been made to ensure the accuracy of information contained in this manual, the Draper Tools policy of continuous improvement determines the right to make modifications without prior warning.

1. TITLE PAGE

1.1 INTRODUCTION

USER MANUAL FOR: 230V 330mm Planer Thicknesser

Stock No: 89156

Part No: PT2000D

1.2 REVISION HISTORY

Date first published: April 2021.

As our user manuals are continually updated, users should make sure that they use the very latest version.

Downloads are available from: <http://drapertools.com/manuals>

Draper Tools Limited
Hursley Road
Chandler's Ford
Eastleigh
Hampshire
SO53 1YF
UK

Website: drapertools.com

Product help line: +44 (0) 23 8049 4344

General Fax: +44 (0) 23 8026 0784

1.3 UNDERSTANDING THIS MANUAL'S SAFETY CONTENT

WARNING! – Information that draws attention to the risk of injury or death.

CAUTION! – Information that draws attention to the risk of damage to the product or surroundings.

1.4 COPYRIGHT © NOTICE

Copyright © Draper Tools Limited.

Permission is granted to reproduce this publication for personal and educational use only. Commercial copying, redistribution, hiring or lending is prohibited.

No part of this publication may be stored in a retrieval system or transmitted in any other form or means without written permission from Draper Tools Limited.

In all cases this copyright notice must remain intact.

2. CONTENTS

2.1 CONTENTS

1. TITLE PAGE	
1.1 INTRODUCTION	2
1.2 REVISION HISTORY	2
1.3 UNDERSTANDING THIS MANUAL'S SAFETY CONTENT	2
1.4 COPYRIGHT © NOTICE	2
2. CONTENTS	
2.1 CONTENTS	3
3. WARRANTY	
3.1 WARRANTY	5
4. INTRODUCTION	
4.1 SCOPE	6
4.2 SPECIFICATION	6
4.3 HANDLING AND STORAGE	6
5. HEALTH AND SAFETY INFORMATION	
5.1 GENERAL SAFETY INSTRUCTIONS FOR POWER TOOL USE	7
5.2 SPECIFIC SAFETY INSTRUCTION FOR PLANER THICKNESSER USE	8
5.3 RESIDUAL RISK	9
5.4 CONNECTION TO THE POWER SUPPLY	9
6. TECHNICAL DESCRIPTION	
6.1 IDENTIFICATION	10
7. UNPACKING AND CHECKING	
7.1 PACKAGING	11
7.2 WHAT'S IN THE BOX	11
8. PREPARING THE PLANER THICKNESSER	
8.1 INSTALLING THE DEPTH ADJUSTMENT HANDLE	12
8.2 ADJUSTING THE DEPTH OF THE PLANER	12
8.3 OPERATING THE SWITCH	13
8.4 USE AND REPLACEMENT OF THE OVERCURRENT PROTECTIVE DEVICE	13
8.5 ADJUSTING THE TABLE EXTENSION	14
8.6 PARALLELISM ADJUSTING	15
8.7 DISMANTLING THE KNIFE BLADE	16
8.8 INSTALLING THE KNIFE BLADE	17
9. OPERATING THE PLANER THICKNESSER	
9.1 COARSE PLANING	18
10. TIPS ON USING YOUR PLANER THICKNESSER	
10.1 PLANING	19
11. TROUBLESHOOTING	
11.1 TROUBLESHOOTING GUIDE	20
12. MAINTENANCE	
12.1 CHECK AND REPLACING THE CARBON BRUSH	21
12.2 LUBRICATION	21
12.3 MAINTENANCE	21

2. CONTENTS

13. EXPLANATION OF SYMBOLS

13.1 EXPLANATION OF SYMBOLS 22

14. DISPOSAL

14.1 DISPOSAL..... 23

3. WARRANTY

3.1 WARRANTY

Draper tools have been carefully tested and inspected before shipment and are guaranteed to be free from defective materials and workmanship.

Should the tool develop a fault, please return the complete tool to your nearest distributor or contact

Draper Tools Limited, Chandler's Ford, Eastleigh, Hampshire, SO53 1YF. England.

Telephone Sales Desk: (023) 8049 4333 or Product Help Line (023) 8049 4344.

A proof of purchase **must** be provided with the tool.

If upon inspection it is found that the fault occurring is due to defective materials or workmanship, repairs will be carried out free of charge. This warranty period covering parts is 24 months and labour is 12 months from the date of purchase except where tools are hired out when the warranty period is 90 days from the date of purchase. This warranty does not apply to any consumable parts, any type of battery or normal wear and tear, nor does it cover any damage caused by misuse, careless or unsafe handling, alterations, accidents, or repairs attempted or made by any personnel other than the authorised Draper warranty repair agent.

Note: If the tool is found not to be within the terms of warranty, repairs and carriage charges will be quoted and made accordingly.

This warranty applies in lieu of any other warranty expressed or implied and variations of its terms are not authorised.

Your Draper warranty is not effective unless you can produce upon request a dated receipt or invoice to verify your proof of purchase within the warranty period.

Please note that this warranty is an additional benefit and does not affect your statutory rights.

Draper Tools Limited.

4. INTRODUCTION

4.1 SCOPE

Part of our core range, this product is suitable for enthusiasts and tradespersons alike. The tool is designed for planing wooden planks and dry wood. You should not use this tool to plane other materials, such as metals, plastics, branches, tree trunks and wet wood.

4.2 SPECIFICATION

STOCK NO.....	89156
PART NO.....	PT2000D
RATED VOLTAGE.....	230V~50HZ
RATED OUTPUT.....	2000W
SPEED.....	8000R/MIN
FEED SPEED.....	6M/MIN
PLANING WIDTH.....	330MM
PLANING DEPTH.....	0 – 3MM
PLANING HEIGHT.....	6 – 160MM
WORKING TABLE SIZE.....	330 X 290MM
EXTERIOR SIZE.....	525 X 696 X 480MM
SOUND PRESSURE LEVEL.....	85dB(A)
WEIGHTS (MACHINE ONLY).....	27.5KG

4.3 HANDLING AND STORAGE

- Care must be taken when handling this product.
 - Dropping this power tool could have an effect on its accuracy and could also result in personal injury. This product is not a toy and must be respected.
- Environmental conditions can have a detrimental effect on this product if neglected.
 - Exposure to damp air can gradually corrode components.
 - If the product is unprotected from dust and debris, components will become clogged.
 - If not cleaned and maintained correctly or regularly, the machine will not perform at its best.

5. HEALTH AND SAFETY INFORMATION

5.1 GENERAL SAFETY INSTRUCTIONS FOR POWER TOOL USE

Warning!

Read all safety warnings, instructions, illustrations and specifications provided with this power tool. Failure to follow all instructions listed below may result in electric shock, fire and/or serious injury.

Save all warnings and instructions for future reference.

The term “power tools” in the warnings refers to your mains-operated (corded) power tool or battery-operated (cordless) power tool.

1) Work area safety

- a) **Keep work area clean and well lit.** Cluttered or dark areas invite accidents.
- b) **Do not operate power tools in explosive atmospheres, such as in the presence of flammable liquids, gases or dust.** Power tools create sparks which may ignite the dust or fumes.
- c) **Keep children and bystanders away while operating a power tool.** Distractions can cause you to lose control.

2) Electrical safety

- a) **Power tool plugs must match the outlet. Never modify the plug in any way. Do not use any adapter plugs with earthed (grounded) power tools.** Unmodified plugs and matching outlets will reduce risk of electric shock.
- b) **Avoid body contact with earthed or grounded surfaces, such as pipes, radiators, ranges and refrigerators.** There is an increased risk of electric shock if your body is earthed or grounded.
- c) **Do not expose power tools to rain or wet conditions.** Water entering a power tool will increase the risk of electric shock.
- d) **Do not abuse the cord. Never use the cord for carrying, pulling or unplugging the power tool. Keep cord away from heat, oil, sharp edges or moving parts.** Damaged or entangled cords increase the risk of electric shock.
- e) **When operating a power tool outdoors, use an extension cord suitable for outdoor use.** Use of a cord suitable for outdoor use reduces the risk of electric shock.
- f) **If operating a power tool in a damp location is unavoidable, use a residual current device (RCD) protected supply.** Use of an RCD reduces the risk of electric shock.

3) Personal safety

- a) **Stay alert, watch what you are doing and use common sense when operating a power tool. Do not use a power tool while you are tired or under the influence of drugs, alcohol or medication.** A moment of inattention while operating power tools may result in serious personal injury.
- b) **Use personal protective equipment Always wear eye protection.** Protective equipment such as a dust mask, non-skid safety shoes, hard hat or hearing protection use for appropriate conditions will reduce personal injuries.
- c) **Prevent unintentional starting. Ensure the switch is in the off-position before connecting to power source and/or battery pack, picking up or carrying the tool.** Carrying power tools with your finger on the switch or energising power tools that have the switch on invites accidents.
- d) **Remove any adjusting key or wrench before turning the power tool on.** A wrench or a key left attached to a rotating part of the power tool may result in personal injury.

5. HEALTH AND SAFETY INFORMATION

- e) **Do not overreach. Keep proper footing and balance at all times.** This enables better control of the power tool in unexpected situations.
- f) **Dress properly. Do not wear loose clothing or jewellery. Keep your hair and clothing away from moving parts.** Loose clothes, jewellery or long hair can be caught in moving parts.
- g) **If devices are provided for the connection of dust extraction and collection facilities, ensure these are connected and properly used.** Use of dust collection can reduce dust-related hazards.
- h) **Do not let familiarity gained from frequent use of tools allow you to become complacent and ignore tool safety principles.** A careless action can cause severe injury within a fraction of a second.

4) Power tool use and care

- a) **Do not force the power tool. Use the correct power tool for your application.**
The correct power tool will do the job better and safer at the rate for which it was designed.
- b) **Do not use the power tool if the switch does not turn it on and off.** Any power tool that cannot be controlled with the switch is dangerous and must be repaired.
- c) **Disconnect the plug from the power source and/or remove the battery pack, if detachable, from the power tool before making any adjustments, changing accessories, or storing power tools.** Such preventive safety measures reduce the risk of starting the power tool accidentally.
- d) **Store idle power tools out of the reach of children and do not allow persons unfamiliar with the power tool or these instructions to operate the power tool.** Power tools are dangerous in the hands of untrained users.
- e) **Maintain power tools and accessories. Check for misalignment or binding of moving parts, breakage of parts and any other condition that may affect the power tool's operation. If damaged, have the power tool repaired before use.** Many accidents are caused by poorly maintained power tools.
- f) **Keep cutting tools sharp and clean.** Properly maintained cutting tools with sharp cutting edges are less likely to bind and are easier to control.
- g) **Use the power tool, accessories and tool bits etc. in accordance with these instructions, taking into account the working conditions and the work to be performed.** Use of the power tool for operations different from those intended could result in a hazardous situation.
- h) **Keep handles and grasping surfaces dry, clean and free from oil and grease.** Slippery handles and grasping surfaces do not allow for safe handling and control of the tool in unexpected situations.

5) Service

- a) **Have your power tool serviced by a qualified repair person using only identical replacements parts.** This will ensure that the safety of the power tool is maintained.

5.2 SPECIFIC SAFETY INSTRUCTION FOR PLANER THICKNESSER USE

Wear safety glasses. Don't cram wood into outfeed side.

Before use, check that all screws connections are properly tightened.

Do not force the tool. Let the feed mechanism do the work. Never insert objects or body parts in the outfeed.

Check regularly that the rubber roller and iron roller are clean. If the rollers are contaminated the workpiece will not infeed correctly – risk of personal injury.

Do not machine workpieces with many knots or sprigs.

The operating position is in front of the machine. Stand by the side of the infeed table.

Remove any nails, screws and other metal objects from the workpiece before machining.

Check that the blades are correctly installed.

Handle the knife blades with care – risk of personal injury and/or damage to property.

Never start the planer until the blade holder has reached full speed.

Never use blunt blades – risk of kickback.

Always replace or sharpen both blades at the same time. Both blades must be of the same size and weight.

Never insert your fingers or other body parts in the chip outlet – risk of personal injury.

Warning!

Please check the recoil claw is in the correct position.

If infeed wood is not smooth, please don't force the wood, check if machine has a problem.

5.3 RESIDUAL RISK

Important: Although the safety instructions and operating manuals for our tools contain extensive instructions of safe working with power tools, every power tool involves a certain residual risk which can not be completely excluded by safety mechanisms. Power tools must therefore always be operated with caution!

5.4 CONNECTION TO THE POWER SUPPLY

Caution: Risk of electric shock. Do not open.

This appliance is supplied with an approved plug and cable for your safety. Never use a damaged or incomplete plug.

This appliance is Class II† and is designed for connection to a power supply matching that detailed on the rating label and compatible with the plug fitted.

Carefully select an extension lead. Some machines are not suitable for use with extension leads. If the tool is designed for use outdoors, only use an extension lead suitable for that environment in conjunction with an RCD adaptor. When using an extension lead, select one capable of handling the current (amps) drawn by the machine in use. Ensure the cable is fully unwound regardless of the distance between the power supply and the tool. Excess current (amps) and a coiled extension lead will cause the cable to heat up and can result in fire.

Keep extension leads away from moving hazardous parts to avoid damages to the cable which can lead to contact with live parts. Position cable safely to avoid tripping over.

†Double insulated : This product requires no earth connection as supplementary insulation is applied to the basic insulation to protect against electric shock in the event of failure of the basic insulation.

Important! If using an extension lead, follow the instructions that came with your lead regarding maximum load while cable is wound. If in doubt, ensure that the entire cable is unwound. Using a coiled extension lead will generate heat which could melt the lead and cause a fire.

6. TECHNICAL DESCRIPTION

6.1 IDENTIFICATION

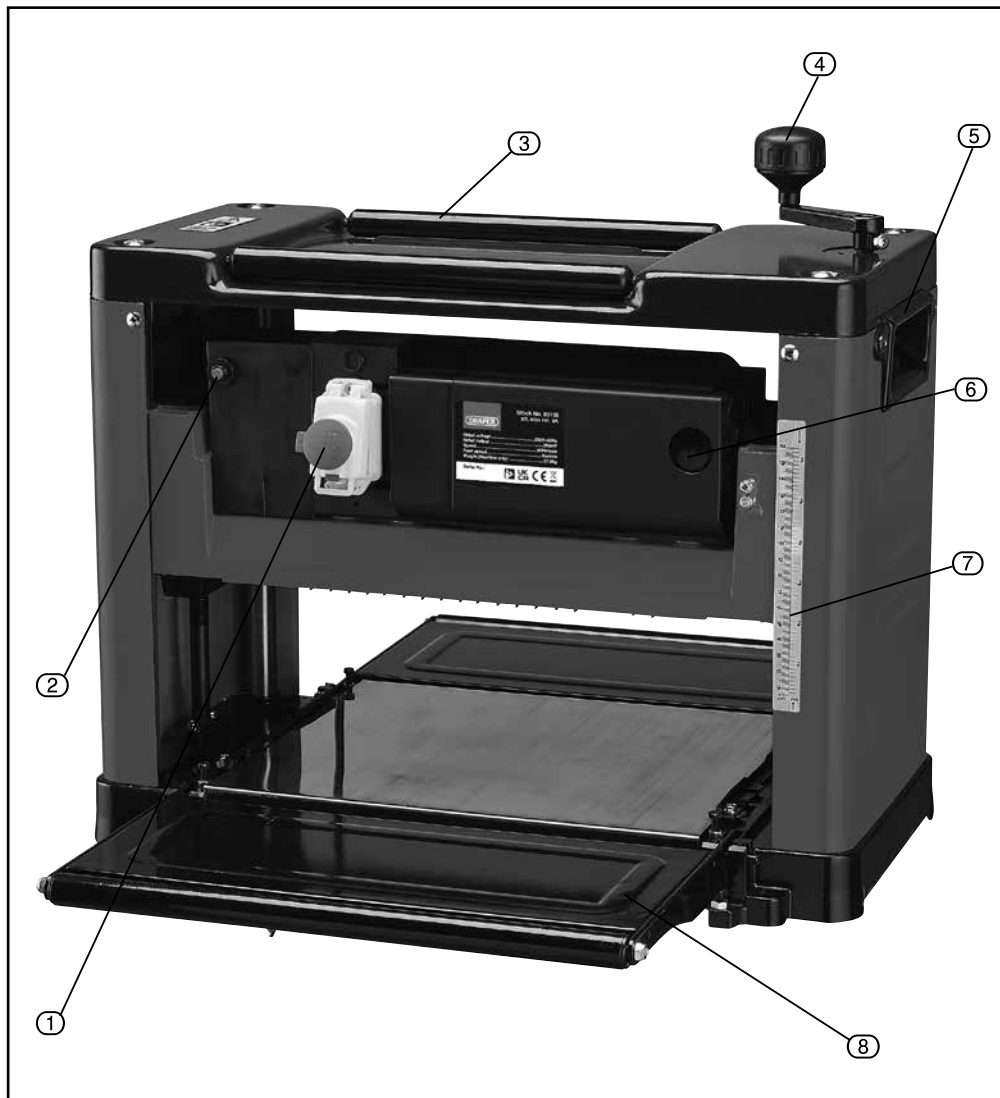

- ① Switch
- ② Overcurrent protective device
- ③ Roller bar
- ④ Depth adjustment handle

- ⑤ Carrying handle
- ⑥ Carbon brush cover
- ⑦ Depth label
- ⑧ Table extension

7. UNPACKING AND CHECKING

7.1 PACKAGING

Carefully remove the product from the packaging and examine it for any sign of damage that may have happened during shipping. Lay the contents out and check them against the parts shown below. If any part is damaged or missing, please contact the Draper Help Line (the telephone number appears on the Title page) and do not attempt to use the product.

The packaging material should be retained at least during the warranty period, in case the machine needs to be returned for repair.

Warning!

- Some of the packaging materials used may be harmful to children. Do not leave any of these materials in the reach of children.
- If any of the packaging is to be thrown away, make sure they are disposed of correctly, according to local regulations.

7.2 WHAT'S IN THE BOX

As well as the planer thicknesser, there are several parts not fitted or attached to it.

Note: For details of our full range of accessories and consumables, please visit drapertools.com

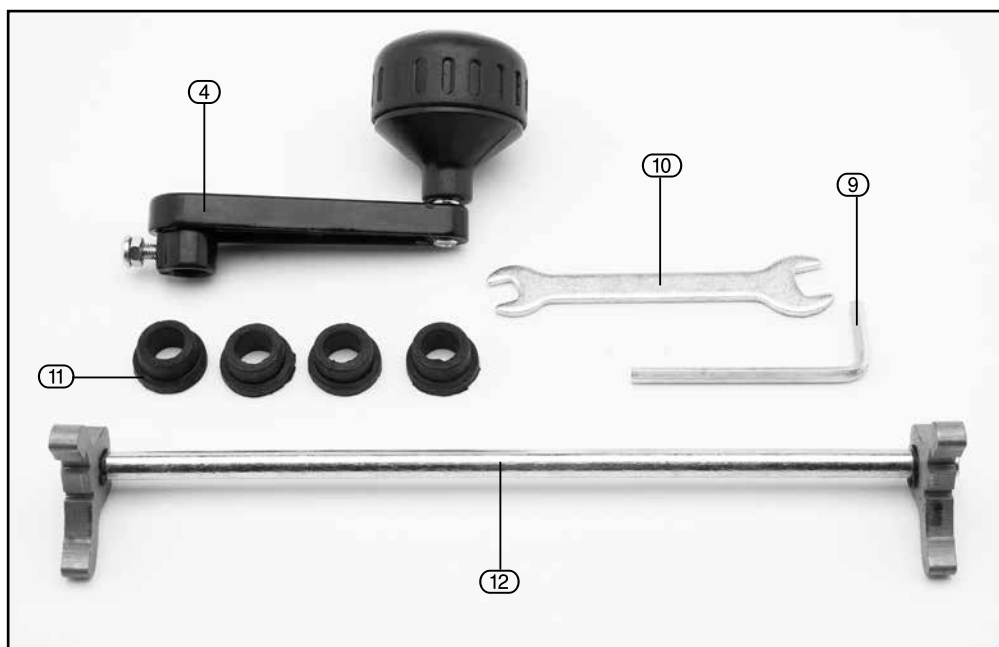

(4) Depth adjustment handle

(9) Hex key

(10) Open wrench

(11) 4 x rubber feet

(12) Blade setting jig

8. PREPARING THE PLANER THICKNESSER

Note: Remove the plug from the socket before carrying out adjustment, servicing or maintenance.

8.1 INSTALLING THE DEPTH ADJUSTMENT HANDLE – FIGS. 1 – 2

Place the depth adjustment handle (4) on the protruding shaft to the right of the machine's top surface. Push on the handle firmly and lock it with the supplied screw.

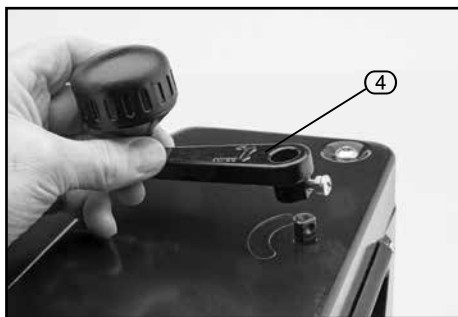

FIG. 1

8.2 ADJUSTING THE DEPTH OF THE PLANER – FIGS. 3 – 4

Rotate the depth adjustment handle 360°. The machine depth can be raised or lowered by 1.5mm.

Before using, plane the wood a few times to ensure the surface of the wood is completely horizontal for later use.

Please refer to the correct wood width range below, to adjust the depth of the one-time planer.

Width of wood (mm)	Cutting depth (mm)
0~100	0~3
160~210	0~2
210~330	0~1

Use a ruler to measure the thickness of the wood to be planed. Then observe depth label (7) to adjust it to the thickness of the plane required.

For example, if the thickness of the wood is 200mm and you want to plane 2mm, the depth label pointer should be at 198mm. In this way, the thickness required can happen using the one-time working process.

Note: The distance between the bottom of the machine and the knife shaft is the thickness of the wood when it is planed. The difference between the thickness of the wood when it comes out of the machine and the thickness when it went in is the thickness of the wood that was shaved off.

Warning!

Do not plane the thickness over 2.5mm at one time. The length of the wood must not be less than 153mm. The thickness of the wood must not be less than 10mm.



FIG. 2



FIG. 3



FIG. 4

8.3 OPERATING THE SWITCH – FIG. 5

Plug the power cord into the mains supply. If you are using an extension cord, the cross section of the conductors must be sufficient for the tool's power supply. Avoid inappropriate use of cable, as this can lead to voltage drop and cause power loss and over heating.

This planer is equipped with an electromagnetic switch. Press the green button marked "I" to start the machine. Press the red button marked "O" to stop the machine.

8.4 USE AND REPLACEMENT OF THE OVERCURRENT PROTECTIVE DEVICE – FIG. 6

When the load power is too large, the current exceeds the load, so the overcurrent protective device will jump.

When this happens, first disconnect the power supply, then press the protective button to reset it.

Don't reboot immediately, allow the machine's temperature to cool, then start it up again.

If the overcurrent protective device jumps frequently, please replace it.



FIG. 5



FIG. 6

8. PREPARING THE PLANER THICKNESSER

8.5 ADJUSTING THE TABLE EXTENSION – FIGS. 7 – 9

Note: This adjustment is already factory set, but please check again to ensure this function operates correctly.

Put the blade holder to a suitable height, so that it is easy to assemble.

Place a horizontal rule on the main worktable, then use it to ensure that the table extension (8) and main worktable are level.

If the table extension is not flush with the main worktable, loosen the nut (A) and turn the screw (B) until table extension's rollers and the main worktable touch the ruler. Adjust both the left and right-hand table extensions.



FIG. 7

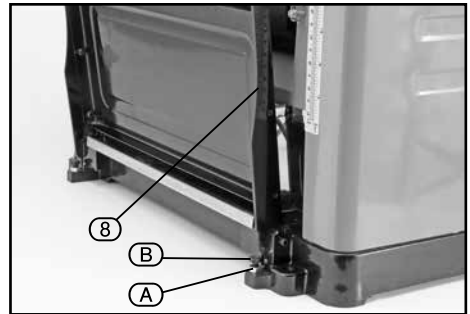

FIG. 8

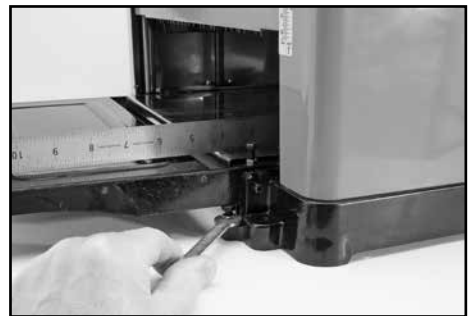

FIG. 9

8.6 PARALLELISM ADJUSTING – FIGS. 10 – 11

Note: This adjustment is already factory set, but please check again to ensure this function operates correctly.

Poor parallelism is usually caused by misaligned blades. Always check that the blade holder and the work table are parallel before attempting to adjust the parallelism setting.

Place the machine on its side and rotate the cross rod bearings (C).

Move the conical gear wheel (D) towards the clamp until it runs freely from the second gear wheel.

Turn the second gear wheel to adjust the height of the blade holder on the side where the gear wheels are located. One tooth shifting anti-clockwise raises the blade holder 0.1mm.

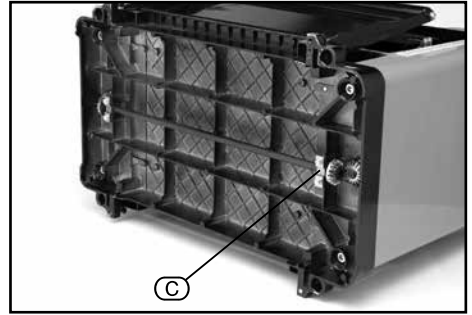

FIG. 10



FIG. 11

8. PREPARING THE PLANER THICKNESSER

8.7 DISMANTLING THE KNIFE BLADE – FIGS. 12 – 14

Warning!

Turn off the machine, unplug the power cord and wait until all moving parts have stopped completely before replacing or adjusting the blades.

Use hex key to remove the dust hood (E) by loosening the screws (F).

Use the open wrench (10) to loosen the blade locking plate and knife blade by turning the outer hexagon bolt (G) clockwise. The knife blades are spring-loaded and can be removed when the blade locking plate is removed.

Remove the knife blade and blade locking plate.

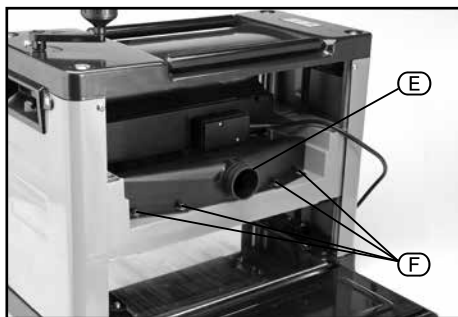

FIG. 12

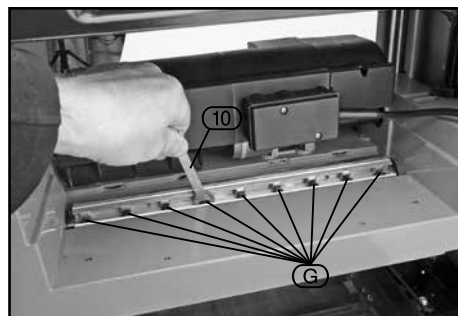

FIG. 13

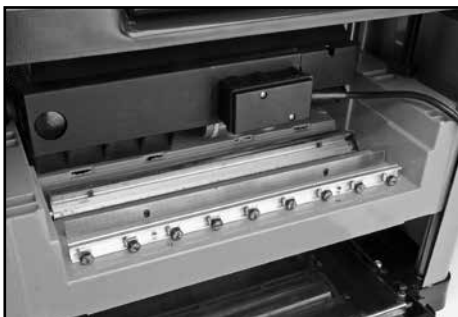

FIG. 14

8.8 INSTALLING THE KNIFE BLADE – FIGS. 15 – 18

Place the knife blade (H) against the blade locking plate (I), in the correct position relative to the pins.

Insert the knife blade and knife locking plate together in the slot and lock in position by turning the outer hexagon bolt (J) anticlockwise. Ensure that the blades face in the right direction.

Set the height of the knife shaft of the knife blades as 1mm on the bit gauge (K). The two support blocks on the left and right side of the bit gauge are pressed against the knife blade. Loosen the clamping screws if necessary, to move the blade to the correct position. When the knife blade is positioned correctly, hold it firmly in place and tighten all outer hexagon bolts.

Warning!

Check that all 18 screws are tightened. Turn the blade holder by hand to check that it rotates easily and smoothly.

Handle the blades with caution to avoid personal injury and/or damage.

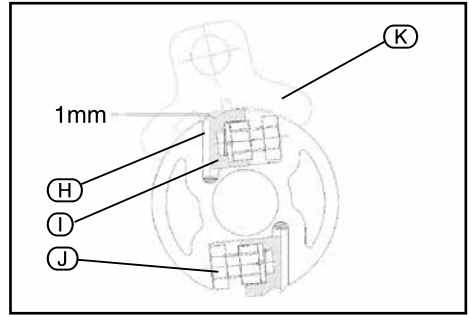

FIG. 15

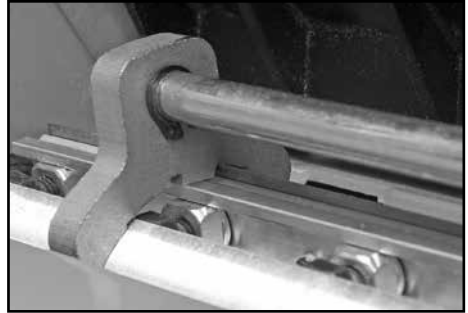

FIG. 16

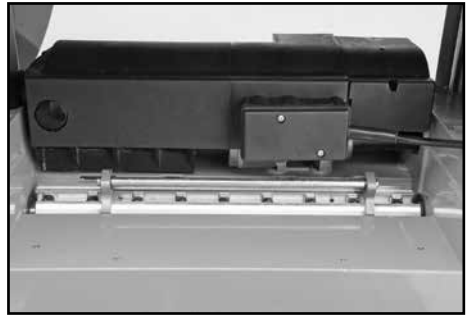

FIG. 17

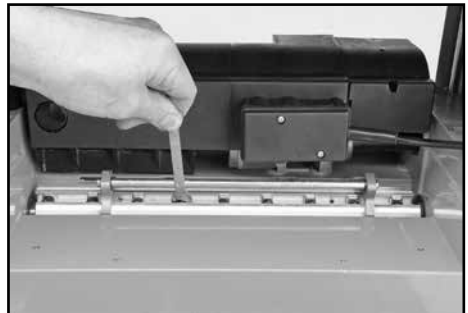

FIG. 18

9. OPERATING THE PLANER THICKNESSER

9.1 COARSE PLANING

Coarse planing is used to provide a reference surface for machining.

Set a small removal setting for the best surface finish.

Process where possible along the grain.

Note: the surface finish is affected by various factors (the wood's hardness, moisture content, fibre structure, blade sharpness, machining direction, material removal per pass etc.)

Perform test machining to find the best setting.

10. TIPS ON USING YOUR PLANER THICKNESSER

10.1 PLANING

Planing involves material removal of the workpiece to the desired thickness, the machining of the surface opposite a coarse planed reference surface.

The maximum material removal per pass is 2.5mm. Multiple machining passes may be needed.

11. TROUBLESHOOTING

11.1 TROUBLESHOOTING GUIDE

Warning!

For your own safety, turn the switch off and remove the plug from the power supply socket.

Problem	Possible Cause	Remedy
Machine will not start.	Machine not plugged in. Fuse blown. Cable damaged. Incorrectly set up.	Plug in the machine. Replace fuse. Replace cable. Double check micro-switch/ selector switch positions.
Loss of cutting performance.	Blades have become blunt. Drive belt slipping.	Replace the pair of blades. Tension or replace belt.
Work piece surface uneven or cracked.	Blades have become blunt. Cutter block clogged. Blades fitted backward. Work piece insufficiently dry. Work piece cut against the grain Excessive amount of material removed.	Replace the pair of blades. Remove sawdust/sap. Refit correctly. Use another piece with lower moisture content. Reverse work piece and feed again. Reduce material removal on next pass (maximum 3mm removal per pass).
Reduced feed rate.	Table surface dirty. Roller drive belt slipping Roller drive mechanism stiff.	Clean off any sap. Replace belt Lubricate drive bearings and mechanism
Work piece jams when thickening.	Work piece too large. Excessive amount of material removed.	Maximum capacity 160mm. Reduce material removal on next pass (maximum 3mm removal per pass).

Note: Repairs should only be carried out by a qualified person.

12. MAINTENANCE

Warning!

Turn off the machine and unplug the power cord before cleaning and maintenance. Do not use water or other liquids to clean electrical parts.

12.1 CHECK AND REPLACING THE CARBON BRUSH

Turn off the machine, unplug the power cord and wait until all moving parts have stopped completely.

Dismantle the carbon brush cover using a screw driver.

Replace the carbon brush, the minimum length of each brush should be 6mm.

Fit the new carbon brushes. Always replace both carbon brush at the same time.

Replace the carbon brush cover.

12.2 LUBRICATION

Regularly remove shavings from the depth setting chains, reduction drive and lifting screws for the blade holder.

Remove chips with a cloth and brush and lightly grease with a clean brush dipped in oil.

Never pour oil directly on the components – too much oil means dust will stick and impair lubrication, which in turn shortens component life.

The blade holder's bearings are sealed and must not be lubricated.

12.3 MAINTENANCE

Keep the machine clean and free of dust and chips.

Clean reapped materials from the blade holder and tongues and carefully lubricate with a clean brush dipped in oil.

Remove resin and the like from the rollers and work table with a non-flammable solvent.

Clean plastic parts with a damp cloth and mild detergent. Never immerse the tool in water or any other liquid. Never use detergents or alcohol.

Always check that all guards and other components are correctly fitted before use. Guards or other parts that are damaged must be repaired or replaced by an authorised service centre, unless otherwise specified in these instructions.

13. EXPLANATION OF SYMBOLS

13.1 EXPLANATION OF SYMBOLS



WEEE – Waste Electrical & Electronic Equipment.

Do not dispose of Waste Electrical & Electronic Equipment in with domestic rubbish.



Read the instruction manual.



Wear suitable eye/face protection.



Wear suitable ear defenders.



Keep hands away from blade.



Disable the machine before attempting to maintain it.

14. DISPOSAL

14.1 DISPOSAL

- At the end of the machine's working life, or when it can no longer be repaired, ensure that it is disposed of according to national regulations.
- Contact your local authority for details of collection schemes in your area.

In all circumstances:

- Do not dispose of power tools with domestic waste.
- Do not incinerate.
- Do not dispose of WEEE* as unsorted municipal waste.



* *Waste Electrical & Electronic Equipment.*

CONTACTS

Draper Tools Limited, Hursley Road,
Chandler's Ford, Eastleigh, Hampshire. SO53 1YF. U.K.

Help line: (023) 8049 4344

Sales desk: (023) 8049 4333

Internet: drapertools.com

E-mail: sales@drapertools.com

General enquiries: (023) 8026 6355

Service/Warranty Repair Agent:

For aftersales servicing or warranty repairs, please contact the Draper Tools help line for details of an agent in your local area.

YOUR DRAPER STOCKIST

TATL0421

©Published by Draper Tools Limited.

No part of this publication may be reproduced, stored in a retrieval system or transmitted in any form or by any means, electronic, mechanical photocopying, recording or otherwise without prior permission in writing from Draper Tools Ltd.