

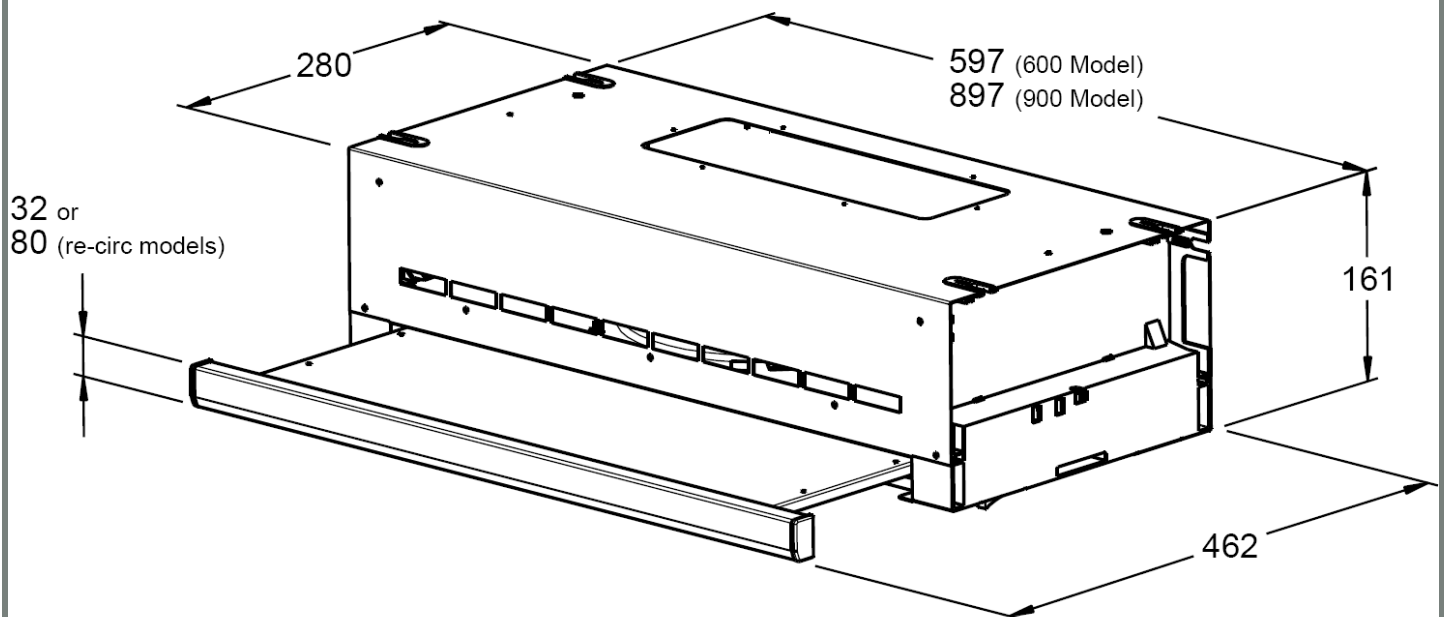











Description: ROBINHOOD SLIDEOUTS
Model: RLES61SS/WH, RLES91SS/WH
Numbers: RI61SS/WH
RO91SS/WH
RO61SS/WH/80



All dimensions in mm
Model may vary slightly from images pictured

Safety Warnings

-  All electrical work must be done by a registered electrician in accordance with local and national electrical codes as applicable. For your safety, this product must be earthed.
-  If the supply cord of this equipment is damaged, it must only be replaced by the manufacturer or its service agent or a similarly qualified person in order to avoid a hazard.
-  This rangehood is designed for indoor use only and must be in a dry location.
-  Disconnect the power supply when changing light bulbs.
-  This appliance is not intended for use by persons (including children) with reduced physical, sensory or mental capabilities, or lack of experience and knowledge, unless they have been given supervision or instruction concerning use of the appliance by a person responsible for their safety.
-  Young children should be supervised to ensure that they do not play with the appliance.
-  There shall be adequate ventilation of the room when the rangehood is used at the same time as appliances burning gas or other fuels.
-  There is a fire risk if cleaning is not carried out in accordance with the instructions. You must read the details concerning the method and frequency of cleaning.
-  Do not flambé under the rangehood.
-  Exhaust air must not be discharged into an existing flue which is used for exhausting fumes from appliances burning gas or other fuels.
-  The minimum distance between the hob surface and the lowest part of the rangehood is 600mm. This distance shall be at least 650mm, if the rangehood is installed over a gas hob. If the instructions for the gas hob specify a greater distance, this has to be taken into account.
-  Attention should be given to ensure that any applicable regulations concerning the discharge of exhaust air is fulfilled.

Product approvals

Product approval number	V08526	RT6WH, RT6SS, RT9WH, RT9SS RLES6WH, RLES6SS, RLES9WH, RLES9SS RI6WH, RI6SS, RI9WH, RI9SS RO6WH, RO6SS, RO9WH, RO9SS RO6WH80, RO6SS80 RV6WH, RV6SS, RV9WH, RV9SS
	V090448	RLES61WH, RLES61SS, RLES91WH, RLES91SS RI61WH, RI61SS RO61WH, RO61SS, RO91WH, RO91SS RO61WH80, RO61SS80
Product rating	165W Max at 230-240V 50Hz (RLES's, RV's – 3 sp axial) 160W Max at 230-240V 50Hz (RO's – 2 sp axial) 185W Max at 230-240V 50Hz (RI's, RT's – 3 sp centrif.)	
Electric approval	AS/NZS 60335.2.31: 2004 incl. A1-2	
EMC approval	AS/NZS CISPR 14, 2002	
Performance tested	AS2682-1984	

Overview

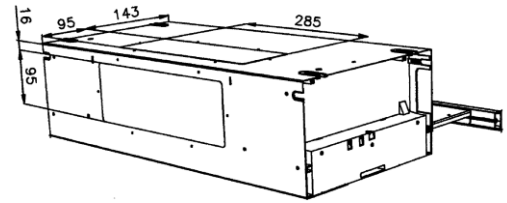
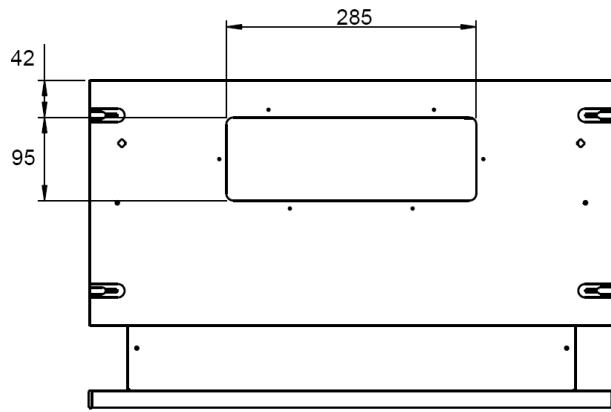

Plan

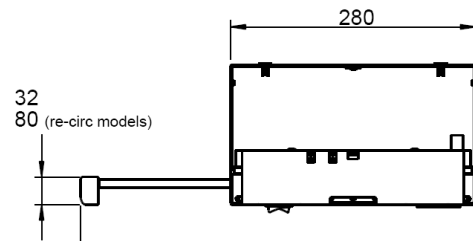
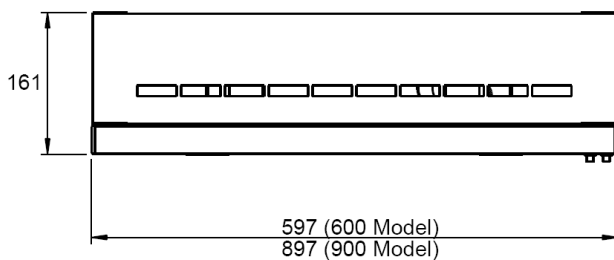











Front

Side

Pre-installation

Thank you for purchasing a quality Robinhood rangehood. Robinhood has a high standard of quality control and every rangehood is tested and approved before it leaves the factory.

Important:

-  Please read the entire instructions before installing the rangehood.
-  Always switch power off prior to installation.
-  All electrical work must be done in accordance with local and national electrical codes as applicable.
-  For safety, this product must be earthed.
-  A power outlet should be within 1000mm of the power cord exit from the rangehood.
-  The socket must be accessible and enable the end user to isolate the rangehood from the power for the purpose of internal cleaning or maintenance.
-  Stainless steel or powder coat is very easily damaged during installation if abraded or knocked by tools. Protect the rangehood with the cardboard box or plastic bag during installation.
-  All ducting must comply with local requirements and building codes.
-  Suitable fixings will be required to mount this rangehood.
-  See Ducting options next page.

Contents of packaging:

- 1 x rangehood
- 1 x Installation sheet
- 1 x Installation kit - "SIDE FIXING"
- 1 x Installation kit - "TOP FIXING"
- 1 x Charcoal Filter (RO61SS/WH/80 only)
- Multiple Handle Colour Options

Typical equipment required:

- electric drill
- screwdriver
- tape measure
- spirit level
- duct tape (if ducting)
- jig saw (if ducting)
- ladder (if ducting)

Ducting Options

The method of ducting should be carefully considered before installing the rangehood. The guide below recommends the ducting components to use for all common ducting configurations - through the top of the home (for the roof and soffit) and through the rear of the home. 285 x 85mm rectangular or 125mm round ducting (using a rectangular to round adapter) can be used in conjunction with this model rangehood. Alternatively this rangehood can be operated in recirculation mode (see page 4).

The highlighted area in the table below gives the recommended Uniduct item numbers for different mounting and outlet options.

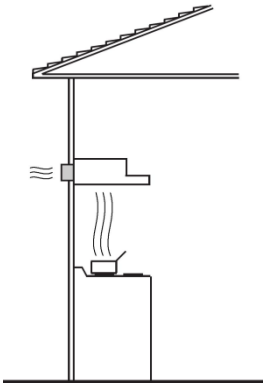
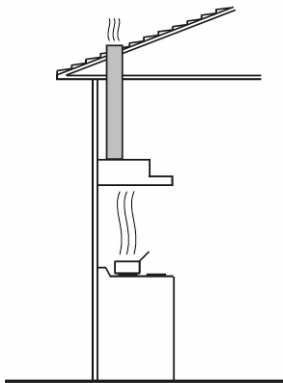
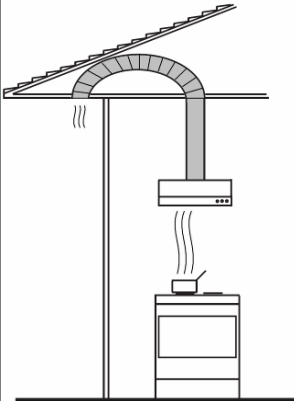
		Duct mounting option		
		Rear	Top (roof)	Top (soffit/eave)
				
		Uniduct item numbers		
Duct outlet option	285mm x 85mm Rectangular outlet	1575	1570 and 1571	1570 and 1596(x2) and 1600
	Ducting outlet adapted to 125mm round		1637 and 1613	1637 and 1687

Extra lengths and/or bends may be required, depending on the length necessary and whether there are any structural members in the way of the run e.g. rafters, beams etc

Please note that this chart is designed as a guide. Please consult Robinhood customer services if unsure.
For NZ phone 0800 760 667 or www.robinhood.co.nz. For AUS phone 1800 648 556 or www.robinhood.com.au.

Pre-Installation - preparing the rangehood for installation

Ducted rangehood

If the rangehood is to be installed as a ducted hood, remove the appropriate duct knockout **A**.

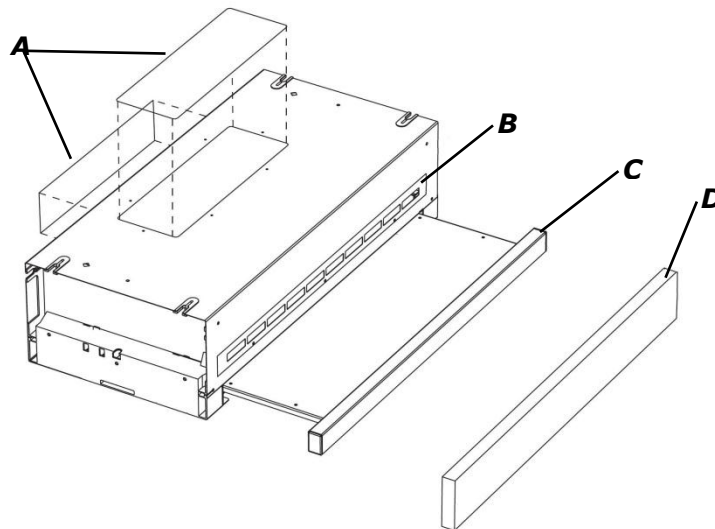

Changing the handle

1. Using a Screwdriver, unscrew the 3 screw on the back of the Handle.
2. Select the desired handle option from those available, and reattach the new handle using the same screws

Recirculating Rangehood (for RO61SS/WH/80 only)

If the Rangehood is to be installed as a recirculating hood, first ensure the overhead cabinets are built according to the diagram below, and

1. Remove the Cover Tape **B**.
2. If an 80mm handle is not installed. Remove the Front Fascia **C** by undoing the 3 screws on the fascia.
3. Replace **C** with the Replacement Front Panel **D** constructed of the same or similar material as the cupboard doors. See the diagram below for the height of panel.

NOTE; RO91SS/WH can be recirculated by fitting a custom made 80mm front fascia. 80mm fascia is not supplied or available for RO91SS/WH. Charcoal Filter part #14961 can be purchased as an accessory.

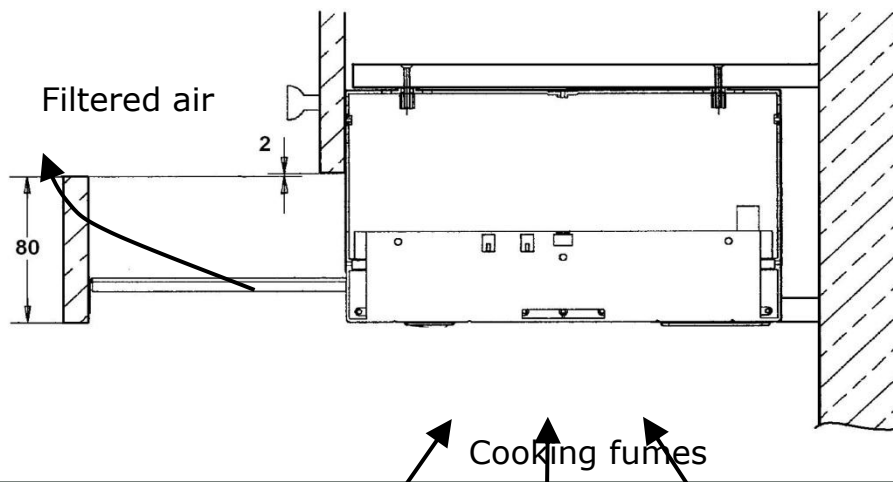

Installation

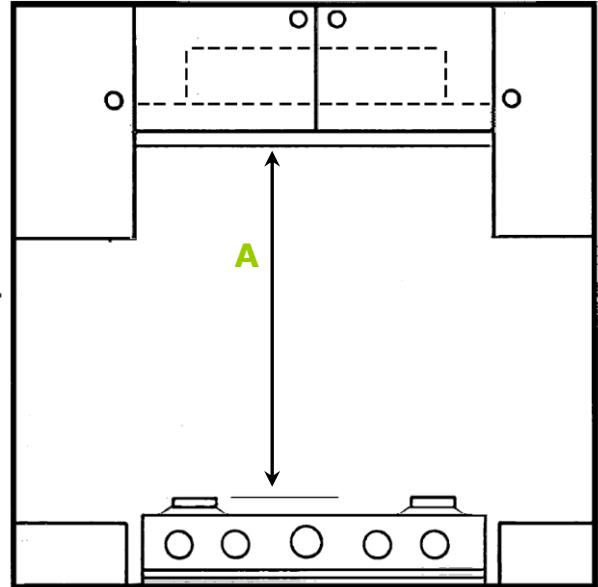
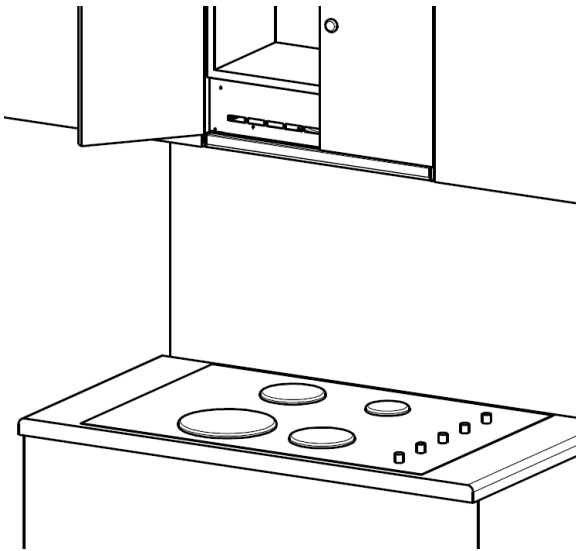

- A** **Minimum** height from the hob surface to the underside face of the rangehood (wall or cabinet mounting)
- 600mm** electric hob
 - 650mm** gas hob

Note: If the instructions for the gas hob specify a greater distance, this has to be taken into account.

Mounting to underside of cabinetry

Fix the rangehood to a shelf mounted at the correct height in the wall unit, by drilling four holes (see diagram below) and fixing with the four screws supplied (found in the bag labelled "**TOP FIXING**"). Double check the dimensions with the rangehood before the holes are drilled, especially the dimension from the **front of the cupboard door** to the first holes (60mm)

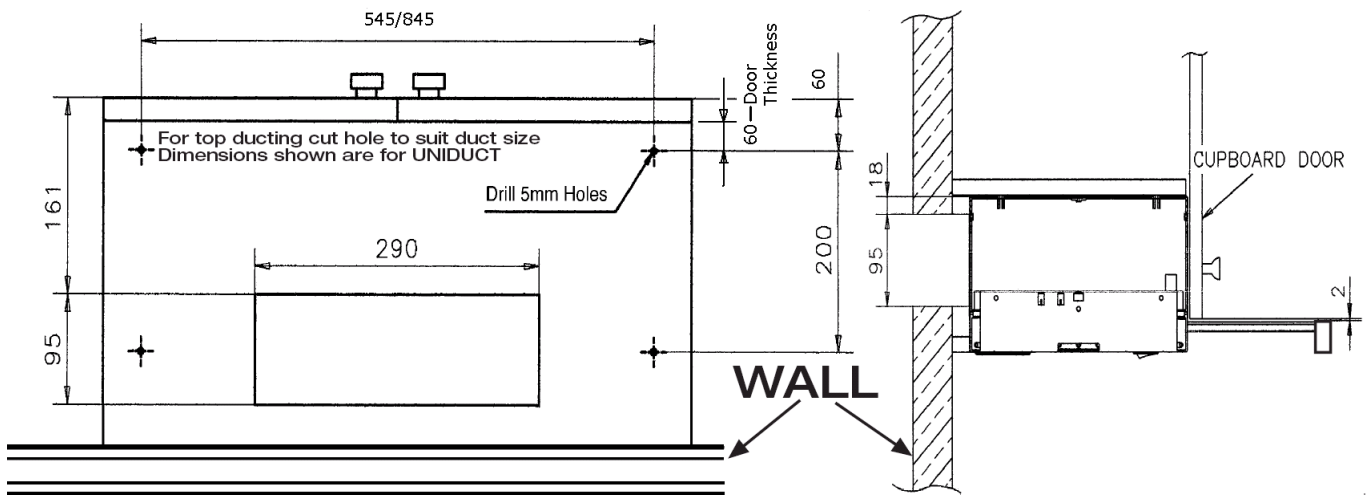

PLEASE NOTE: Using the incorrect screws for the installed mounting method may cause damage to the product. This damage may lead to failure of the top mounting anchor points and this would not be covered by the warranty.

The sides, top, front and rear of the product (excluding the handle) should not be accessible during normal operation after installation. This unit is designed to be hidden or inbuilt into the kitchen cabinetry.

Mounting to the cabinetry sides

When side mounting, the rangehood is fastened with countersunk screws and metal tubes through the plastic sides of the rangehood into the wooden sides of the cabinet above the cooking area. The screws clamp the metal tubes to the kitchen cabinetry and the rangehood effectively 'floats' on the tubes. This method of installation means that there are no undue stresses caused by the fasteners on the plastic sides.

Three mounting points are provided on each side of the rangehood for your convenience, it is important that all three screws are used on either side to firmly secure your rangehood in place. If you use two screws per side it is recommended that you also secure the rangehood with two screws from the top as per the instructions on the previous page

When mounting to the cabinetry sides, please ensure the correct screws are used. These can be found in the bag labelled "**SIDE FIXING**". Before starting check the length of the screws with the thickness of the cabinet sides and the length of the metal tubes to ensure the screws do not break through the sides of the cabinet.

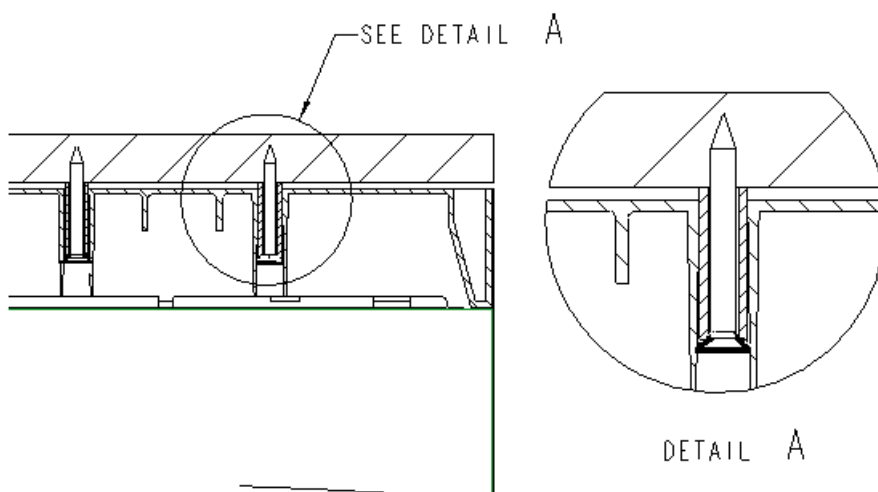
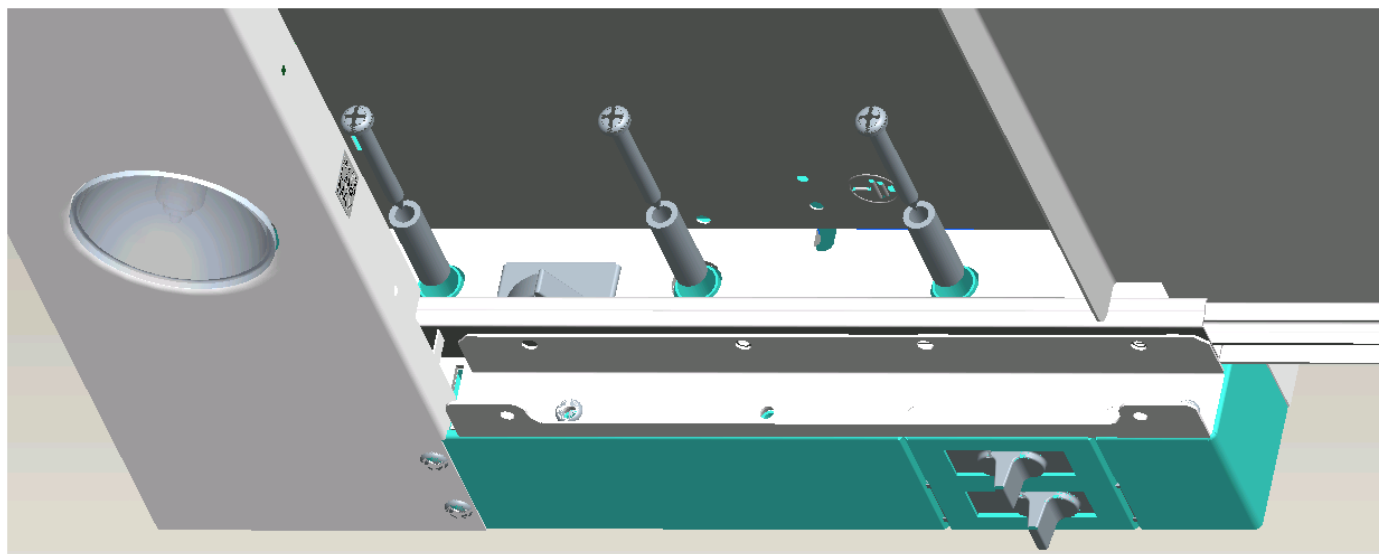

PLEASE NOTE: Using the incorrect screws for the installed mounting method or not using the metal tubes as per these instructions may cause damage to the product. This damage may lead to failure of the side mounting anchor points and this would not be covered by the warranty.

The recommended distance between the cabinet sides is 600/900mm depending on the model purchased. If the distance is larger than recommended, you can eliminate any sideways movement by using packers or fixing from the top as described earlier.

Operating instructions

Light

The light can be operated independently from the fan and is controlled in accordance with the graphics printed on the control panel.

Fan

The fan can be run at different speeds depending on the cooking requirements and is controlled in accordance with the graphics printed on the control panel.

Cleaning and maintenance

General Maintenance

Switch off the rangehood before cleaning or maintenance. To prevent surface damage never use abrasive or oil based liquid cleaners. To clean the surfaces of the appliance, use mild detergent and warm water. In areas of high humidity and coastal environments cleaning should be carried out frequently.

Warning: a build up of oil may occur if the compact canopy is not cleaned regularly.

Filter Maintenance

To maintain efficiency, the filters should be removed regularly (approximately monthly), and washed using hot soapy water or the dishwasher. **Note - some discolouration of the frame may occur if washed in the dishwasher.**

Rangehoods fitted with charcoal filters are designed to remove grease and odours from cooking vapours prior to the cleansed air re-entering the kitchen (when the rangehood is in recirculation mode). Charcoal filters should be replaced every two to four months depending on use.

Note: Fully saturated charcoal filters can become a barrier to air movement therefore limiting rangehood performance. In the event of fire, grease laden filters could be flammable and therefore regular replacement is recommended. In ducted installations, conventional aluminium filters are recommended.

Replacement of Halogen Lamps



Before changing the lamp ensure the power supply has been disconnected to the rangehood and allow the lamp too cool down in temperature before attempting to remove.

To replace a lamp, first disconnect the rangehood from the power supply. Apply finger pressure to the face of the lamp and twist one quarter turn anti-clockwise, the lamp will now be free to drop out. Insert the replacement lamp into the lamp holder, apply finger pressure and twist one quarter turn clockwise.

For any other problems please call help line on NZ 0800 760 667 or AUS 1800 648 556

Warranty Certificate (New Zealand)

Terms and Conditions

The following conditions apply in respect of the warranty given in this certificate:

1. Parbury Pty Limited ("Parbury") warrants the following Robinhood products against manufacturing defects and faulty materials, under normal use and subject to the exclusions in this certificate, for a period of:
Rangehood - 24 months from date of original purchase for domestic use.
Uniduct - 12 months from date of original purchase for domestic use.
Ironing centre - 12 months from date of original purchase for domestic use.
Waste disposal - 24 months from date of original purchase for domestic use.
"Original purchase", when used in this certificate, means purchase by the customer directly from Parbury or one of its approved suppliers.
2. This warranty is limited to the repair or replacement, at our option, within the warranty period of any component part which we at our discretion determines to contain faulty materials or a manufacturing defect in breach of this warranty. This warranty is subject to terms and conditions set out in this certificate.
3. The warranty only applies within New Zealand.
4. The customer must produce the original invoice or other purchase documentation as proof of the original purchase date.

Warranty exclusions

1. The warranty does not apply where, in Parbury's opinion:
The defect is caused by misuse, wear and tear, dirt, fire or accidental damage.
The product has been repaired or serviced by an unauthorised person.
The product was not installed in accordance with our instructions.
The product was purchased overseas or was not designed for use in New Zealand.
The product was not used, cleaned or cared for in accordance with our instructions.
The product was used outdoors.
All Robinhood rangehoods are suitable for indoor use only, and not suitable over BBQs or charcoal cookers designed for outdoor use.
2. In addition, this warranty does not extend to damage or defects which in our opinion, directly or indirectly arise from or
Exposing the product to acidic or corrosive materials or chemicals such as dyes, solvents, denture cleaner or acetone;
Using inappropriate household cleaning products such as abrasive cream or powder cleansers, furniture polish, bleach, mentholated spirits, drain cleaners, sugar soap, metal pads and strongly alkaline or acidic cleaners;
Heat damage, including from washing the product at high temperatures;
Impact or mishandling the product, including the impact caused by objects scraped along, thrown or dropped on the surface or excessive weight being placed on the product;
Structural or support changes in or affecting the building or the application where the product has been installed;
Failure to clean or maintain the product as recommended; or
Any other causes specified in the product information as being excluded from this warranty.
3. Variations with the colour or gloss within the product or any ageing or fading of colour, shine or gloss level over time are not covered by this warranty. The warranty does not cover visual imperfections or blemishes in the surface and edges of product that were not brought to your supplier's attention at the time you inspected the product.
4. Costs incurred on installation or removal of a product, or any reinstallation of a product, or any associated costs, are not covered by this warranty.
5. Parbury will not be liable for consequential or indirect loss or damage whatsoever and however arising out of or in with the supply, performance or removal of the product, including (but not limited to) loss of profit, loss of revenue, loss of contract, loss of goodwill or increased cost of workings, even if due to the negligence of Parbury or any of its approved suppliers, employees or agents.
6. Charcoal filters and light bulbs are not covered by this warranty
7. This warranty and the statements contained in this certificate or other documents given to you do not exclude, restrict or modify the application of any term implied into this warranty by statute, provided that (to the extent any statutory permits Parbury to limit its liability for a breach of an implied condition or warranty) Parbury's liability for such breach is to the payment of the cost of replacing the product, repairing the product or acquiring an equivalent product.
8. Subject to clause 5, our obligations under this warranty are limited to those set out in this certificate, and this warranty is expressly instead of all other warranties, express or implied, including any implied warranty of merchantability or fitness particular purpose and notwithstanding any course of dealing between the parties or custom and usage in trade to the contrary.

Should warranty service be required, please contact us:

Free Phone: 0800 760 667

Free Fax: 0800 276 246

Email: enquiries@robinhood.co.nz

Website: www.robinhood.co.nz

Terms and conditions are subject to change without notice

Warranty Certificate (Australia)

Terms and Conditions

If you are a consumer under the Australian Consumer Law, our goods come with guarantees that cannot be excluded under the Australian Consumer Law. You are entitled to a replacement or refund for a major failure and for compensation for any other reasonably foreseeable loss or damage. You are also entitled to have the goods repaired or replaced if the goods fail to be of acceptable quality and the failure does not amount to a major failure

1. Parbury Pty Limited ("Parbury") also warrants the following Robinhood products against manufacturing defects and faulty materials, under normal use and subject to the exclusions in this certificate, for a period of:

Rangehood, Ovens, Cooktops - 24 months from date of original purchase for domestic use.

Uniduct – 12 months from date of original purchase for domestic use.

Ironing centre – 12 months from date of original purchase for domestic use.

Taps, including Pull-out and Mixer taps – 5 years on parts only from date of original purchase domestic for use, 24 months parts and labour from date of original purchase for domestic use

Sinks sets– 5 years on stainless steel sink including draining bench from date of original purchase for domestic use, 6 months on all stainless steel accessories, including wire rack, colander and tray from date of original purchase for domestic use.

Supertub - 5 years on stainless bowl, 24 months on Tap, Cabinet and other components from the date of original purchase for domestic use.

"Original purchase", when used in this certificate, means purchase by the customer directly from Parbury or one of its approved suppliers.

2. This warranty is limited to the repair or replacement, at our option, within the warranty period of any component part which we at our discretion determine to contain faulty materials or a manufacturing defect in breach of this warranty. This warranty is subject to terms and conditions set out in this certificate.

3. The warranty only applies within Australia.

4. For warranty service outside of capital city metropolitan area or 30 km from nearest authorised service agent you will be liable for reasonable travelling expenses and the cost of transport of the product or parts to and from the service agent

5. To make a claim under this warranty, you must produce the original invoice or other purchase documentation as proof of the original purchase date. You must send your claim to Parbury Pty Limited, 76 Postle Street, Coopers Plains QLD 4108 within 7 days of any alleged defect or failure of the product first becoming apparent, you are responsible for the expense of making a claim under this warranty.

This warranty is given by:

Parbury Pty Ltd

ABN 83 004 568 138

Telephone: 1800 648 556

Facsimile: 1800 628 577

Email: enquiries@robinhood.com.au

www.robinhood.com.au

Attention Customer Services Manager

Warranty exclusions

1. The warranty does not apply where, in Parbury's opinion:

The defect is caused by misuse, wear and tear, dirt, fire or accidental damage.

The product has been repaired or serviced by an unauthorised person.

The product was not installed in accordance with our instructions.

The product was purchased overseas or was not designed for use in Australia.

The product was not used, cleaned or cared for in accordance with our instructions.

The product was used outdoors.

2. All Robinhood rangehoods are suitable for indoor use only and not suitable over BBQs or charcoal cookers designed for outdoor use.

3. In addition, this warranty does not extend to damage or defects which in our opinion, directly or indirectly arise from or are due to: exposing the product to acidic or corrosive materials or chemicals such as dyes, solvents, denture cleaner or acetone; using inappropriate household cleaning products such as abrasive cream or powder cleansers, furniture polish, bleach, mentholated spirits, drain cleaners, sugar soap, metal pads and strongly alkaline or acidic cleaners; heat damage, including from washing the product at high temperatures;

impact or mishandling the product, including the impact caused by objects scraped along, thrown or dropped on the product surface or excessive weight being placed on the product; structural or support changes in or affecting the building or the application where the product has been installed; failure to clean or maintain the product as recommended; or any other causes specified in the product information as being excluded from this warranty.

4. Variations with the colour or gloss within the product or any ageing or fading of colour, shine or gloss level over time are not covered by this warranty. The warranty does not cover visual imperfections or blemishes in the surface and edges of the product that were not brought to your supplier's attention at the time you inspected the product.

5. We will not be responsible under this warranty for, nor pay the costs of, removing the existing product, or reinstalling the new product, or any associated costs or damages.

6. Charcoal filters and light bulbs are not covered by this warranty

The benefits given by this warranty are in addition to other rights and remedies of consumers under any law in relation to the goods which cannot be excluded.

This warranty certificate is not intended to create a contract between Parbury Pty Limited and the purchaser.

New Zealand

Parbury Pty Ltd

Telephone: 0800 760 667

Facsimile: 0800 276 246

Email: enquiries@robinhood.co.nz

www.robinhood.co.nz

Australia

Parbury Pty Limited

(ABN 83 004 568 138)

Telephone: 1800 648 556

Facsimile: 1800 628 577

Email: enquiries@robinhood.com.au

www.robinhood.com.au

