

# Use & Care Guide

## Built-In Wall Oven



 **Electrolux**

318 205 122 (0803) Rev. D

# 2 Finding Information

---

## MAKE A RECORD FOR FUTURE USE

---

Brand \_\_\_\_\_

Purchase Date \_\_\_\_\_

Model Number \_\_\_\_\_

Serial Number \_\_\_\_\_

## MODEL AND SERIAL NUMBER LOCATION

---

### NOTE

The serial plate is located along the interior side trim of the oven and visible when the door is opened. See picture below.

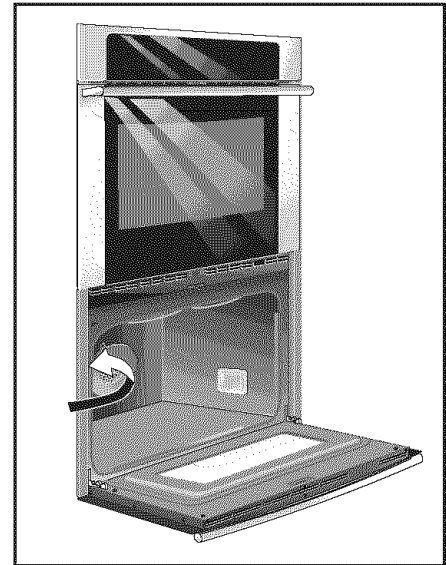

## QUESTIONS?

---

For toll-free telephone support in the U.S. and Canada:  
**1-877-4ELECTROLUX (1-877-435-3287)**

For online support and internet product information:  
**[www.electroluxappliances.com](http://www.electroluxappliances.com)**

©2008 Electrolux Home Products, Inc.  
Post Office Box 212378, Augusta, Georgia 30917, USA  
All rights reserved. Printed in the USA

## TABLE OF CONTENTS

<b>Finding Information</b> .....	<b>2</b>	<b>Electronic Control Settings</b> .....	<b>29</b>
Make a Record for Future Use .....	2	User Preferences Menu .....	29
Model and Serial Number Location .....	2	Setting the Clock .....	29
Questions? .....	2	Setting Clock Display .....	30
Table of Contents .....	3	Setting Time of Day Display .....	30
<b>Safety</b> .....	<b>4</b>	Adjusting Oven Temperature .....	30
Important Safety Instructions .....	4-6	Setting Temperature Display .....	31
<b>Feature Overview</b> .....	<b>7</b>	Setting Silent Control Operation .....	31
Your Wall Oven .....	7	Setting Continuous Bake .....	31
Oven Rack Supports and Oven Vents .....	8	Re-setting to Default Factory Settings .....	31
Removing and Replacing Oven Racks .....	9	<b>Oven Controls</b> .....	<b>32</b>
Control Pad Functions .....	10-11	My Favorites .....	32
<b>Getting Started</b> .....	<b>12</b>	Sabbath Feature .....	33-34
Setting Clock at Power Up .....	12	<b>Care &amp; Cleaning</b> .....	<b>35</b>
Control Panel Display Modes .....	12	Using the Self-Clean Feature .....	35
Temperature Visual Display .....	12	Starting the Self-Clean Cycle .....	36
Oven Light .....	13	General Cleaning .....	37
Control Lock .....	13	Care and Cleaning of Stainless Steel .....	38
Setting the Kitchen Timer .....	13	To Remove and Replace Oven Door .....	38
<b>Cooking Modes</b> .....	<b>14</b>	Special Door Care Instructions .....	38
Baking .....	14	Oven Light .....	39
Cook Time .....	15	Broiler Pan Cleaning Tips .....	39
End Time .....	15	<b>Solutions to Common Problems</b> .....	<b>40</b>
Broiling .....	16	Baking Problems .....	40
Convection Baking .....	17	Solutions .....	41-42
Convection Convert .....	18	<b>Notes</b> .....	<b>43</b>
Rapid Preheat .....	18	<b>Warranty Information</b> .....	<b>44</b>
Convection Roasting .....	19		
Convection Broiling .....	20		
Keep Warm .....	21		
Slow Cook .....	22		
Dehydrating .....	23		
Defrosting .....	23		
Bread Proofing .....	24		
Perfect Turkey .....	25		
Temperature Probe .....	26		
Multi Stage .....	27-28		

# 4 Safety

## IMPORTANT SAFETY INSTRUCTIONS

Please read all safety instructions before using your new Electrolux wall oven.

### **WARNING**

To reduce the risk of fire, electrical shock, or injury when using your wall oven, follow basic precautions including the following:

- Remove all tape and packaging wrap before using the appliance. Destroy the carton and plastic bags after unpacking the appliance. Never allow children to play with packaging material. Do not remove the wiring label and other literature attached to the back of the wall oven. Do not remove model/serial number plate.
- Proper Installation—Be sure your appliance is properly installed and grounded by a qualified electrician or installer in accordance with the National Electrical Code ANSI/NFPA No. 70 (U.S.A.) or CSA C22.1, PART 1 (Canada)—latest editions and local code requirements. Install only per installation instructions provided in the literature package for this appliance.

Ask your dealer to recommend a qualified technician and an authorized repair service. Know how to disconnect the electrical power to the appliance at the circuit breaker or fuse box in case of an emergency.

 **CAUTION** Electronic controllers can be damaged by cold temperatures. When you use your appliance for the first time, or if it has not been used for a long period of time, make sure that it has been exposed to a temperature above 0°C/32°F for at least 3 hours before connecting it to the power supply.

- User Servicing—Do not repair or replace any part of the appliance unless specifically recommended in the manuals. All other servicing should be done only by a qualified technician to reduce the risk of personal injury and damage to the appliance.
- Never modify or alter the construction of the appliance by removing panels, wire covers, or any other part of the product.
- Remove the oven door from any unused appliance if it is to be stored or discarded.

 **WARNING** Stepping, leaning, sitting or pulling down on the door of this appliance can result in serious injuries and may also cause damage to the appliance. Do not allow children to climb or play around the appliance.

- **Storage in or on Appliance—Flammable materials should not be stored in an oven.** This includes paper, plastic and cloth items, such as cookbooks, plasticware and towels, as well as flammable liquids. Do not store explosives, such as aerosol cans, in or near the appliance.

 **WARNING** Do not use the oven for storage.

 **CAUTION** Do not store items of interest to children in the cabinets above an appliance. Children climbing on the oven can be seriously injured.

**⚠ WARNING** To reduce the risk of tipping of the appliance. The appliance must be secured by properly installed anti tip device. To check if devices are installed properly open the oven door and verify that the anti-tip devices are engaged. See installation instructions.

- Do not leave children alone—Children should not be left alone or unattended in the area where an appliance is in use. They should never be allowed to sit or stand on any part of the appliance.
- **DO NOT TOUCH INTERIOR OVEN ELEMENTS OR INTERIOR SURFACES OF THE WALL OVEN UNTIL THEY HAVE COOLED.** The oven heating elements may be hot even though the elements are dark in color. Areas near the elements may become hot enough to cause burns. During and after use, do not touch, or let clothing or other flammable materials touch these areas until they have had sufficient time to cool. Among these areas are the oven vent openings, the surfaces near these openings, oven door and window.
- **Wear Proper Apparel**—Loose-fitting or hanging garments should never be worn while using the appliance. Do not let clothing or other flammable materials contact hot surfaces.

**⚠ WARNING** Never use your appliance for warming or heating the room.

- **Do Not Use Water or Flour on Grease Fires**—Smother the fire with a pan lid, or use baking soda, a dry chemical or foam-type extinguisher.
- When heating fat or grease, watch it closely. Fat or grease may catch fire if allowed to become too hot.
- **Use Only Dry Pot holders**—Moist or damp pot holders on hot surfaces may result in burns from steam. Do not let the pot holders touch the hot heating elements. Do not use a towel or other bulky cloth instead of a pot holder.
- **Do Not Heat Unopened Food Containers**—Build-up of pressure may cause the container to burst and result in injury.

## IMPORTANT INSTRUCTIONS FOR USING YOUR OVEN

- **Use Care When Opening an Oven Door**—Stand to the side of the appliance when opening the door of a hot oven. Let hot air or steam escape before you remove or replace food in the oven.
- **Keep Oven Vent Ducts Unobstructed.** The wall oven is vented at the upper control panel or at the center trim depending on the model. Touching the surfaces in this area when the wall oven is operating may cause severe burns. Also, do not place plastic or heat-sensitive items near the oven vent. These items could melt or ignite.
- **Placement of Oven Racks.** Always place oven racks in desired location while oven is cool. Remove all utensils from the rack before removing rack. If rack must be moved while oven is hot, use extreme caution. Use pot holders and grasp the rack with both hands to reposition. Do not let pot holders contact the hot oven element or interior of the oven.
- **Do not use the broiler pan without its insert.** The broiler pan and grid allow dripping fat to drain and be kept away from the high heat of the broiler.

# 6 Safety

## IMPORTANT SAFETY INSTRUCTIONS

- **Do not cover the broiler grid or oven bottom with aluminum foil.** Exposed fat and grease could ignite.
- **Do not touch a hot oven light bulb with a damp cloth.** Doing so could cause the bulb to break. Disconnect the appliance or shut off the power to the appliance before removing and replacing the bulb.

## IMPORTANT INSTRUCTIONS FOR CLEANING YOUR OVEN

- Clean the appliance regularly to keep all parts free of grease that could catch fire. Exhaust fan ventilation hoods and grease filters should be kept clean. Do not allow grease to accumulate. Greasy deposits in the fan could catch fire. Refer to the hood manufacturer's instructions for cleaning.

### SELF CLEANING OVENS

- Clean in the self-cleaning cycle only the parts of the appliance listed in this Owner's Guide. Before using the self-cleaning cycle of the appliance, remove the broiler pan, oven racks and any utensils stored in the appliance. Also the side rails of the oven racks must be removed for the self-clean function to operate.
- Do not clean the oven door gasket. The door gasket is essential for a good seal. Care should be taken not to rub, damage or move the gasket.
- Do not use oven cleaners. No oven cleaner or oven liner protective coating of any kind should be used in or around any part of the appliance

**⚠ CAUTION** The health of some birds is extremely sensitive to the fumes given off during the self-clean cycle of any wall oven. Move birds to another well ventilated room.

## IMPORTANT SAFETY NOTICE

The California Safe Drinking Water and Toxic Enforcement Act requires the Governor of California to publish a list of substances known to the state to cause cancer, birth defects or other reproductive harm, and requires businesses to warn customers of potential exposure to such substances.

## NOTE

Save these important safety instructions for future reference.

## YOUR WALL OVEN

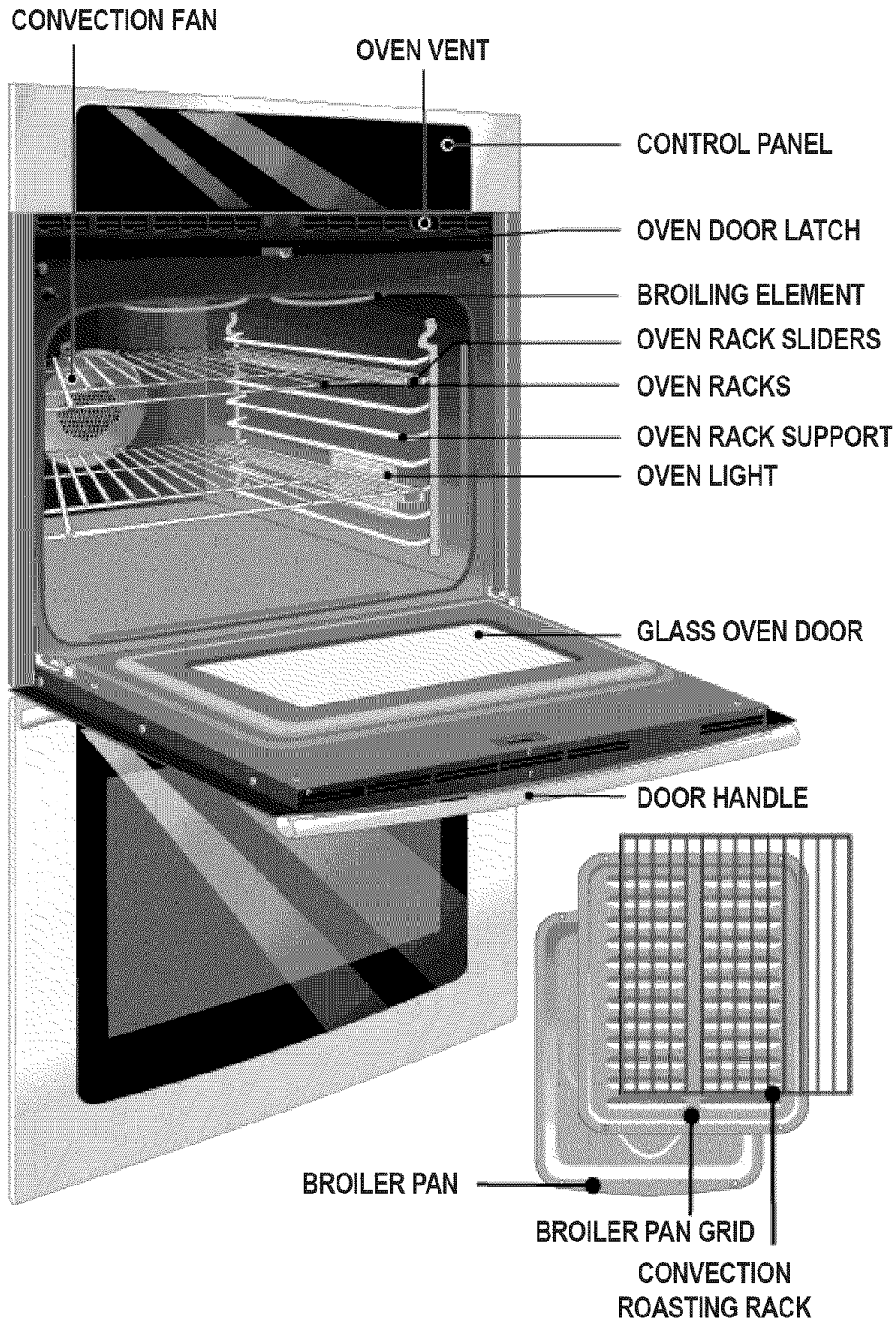

# 8 Feature Overview

## OVEN RACK SUPPORTS & OVEN VENTS

### Installing Oven Rack Supports

*ALWAYS INSTALL OVEN RACK SUPPORT BEFORE TURNING ON THE OVEN (WHEN THE OVEN IS COOL).*

To install oven rack support, insert the supports by pushing them downward into the two brackets on each side of the oven interior, as shown below.

To remove the oven rack support for a self-clean cycle, pull up the support to disengage them from the brackets. If the rack supports are not removed, the self-clean cycle won't start.

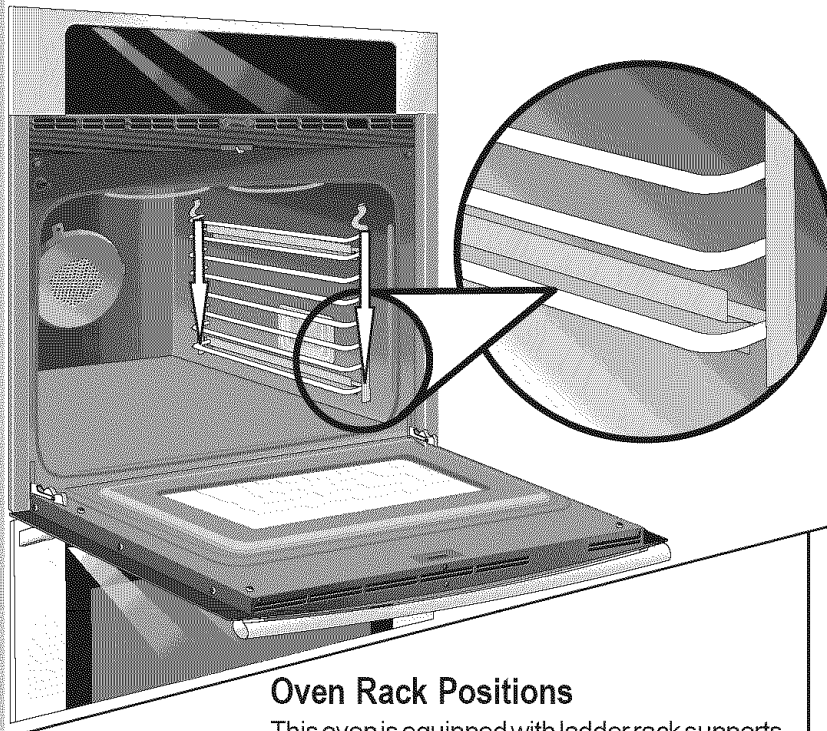

### Oven Rack Positions

This oven is equipped with ladder rack supports with 7 positions to accommodate precisely every mode of cooking.

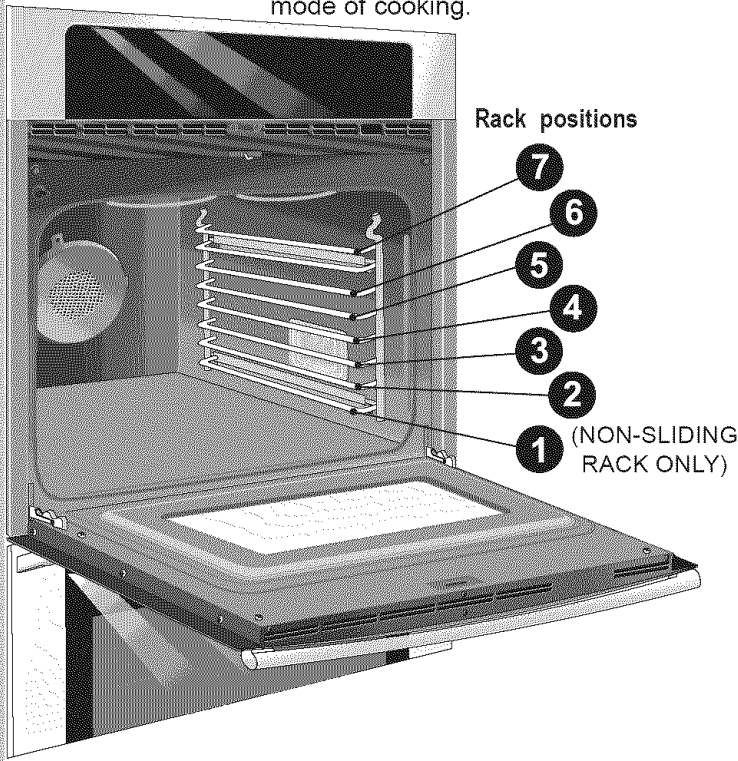

### Oven Vents Location

The oven is vented **above each door**. When the oven is on, warm air is released through the vents. This venting is necessary for proper air circulation in the oven and good baking results.

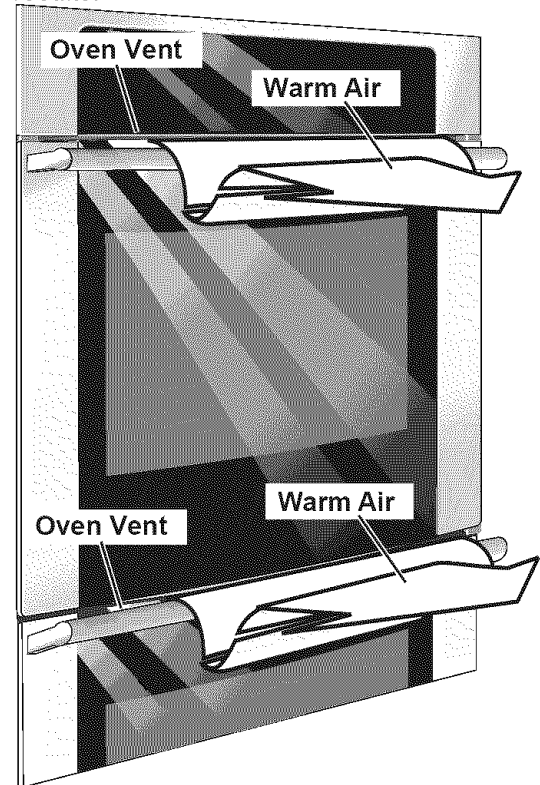

## REMOVING AND REPLACING OVEN RACKS

### Removing Sliding Oven Racks

1. With the rack in its closed position; grasp the rack and the sliders at once.
2. Slightly lift the rack and sliders and pull it to clear the first bracket.
3. Pull the rack and sliders until the second bracket stops the rack.
4. Lift the rack and sliders and carefully remove them from the oven.

Refer to the care and cleaning section for directions on how to clean the racks.

### Replacing Sliding Oven Racks

To replace the oven racks, follow the instructions above in reverse order.

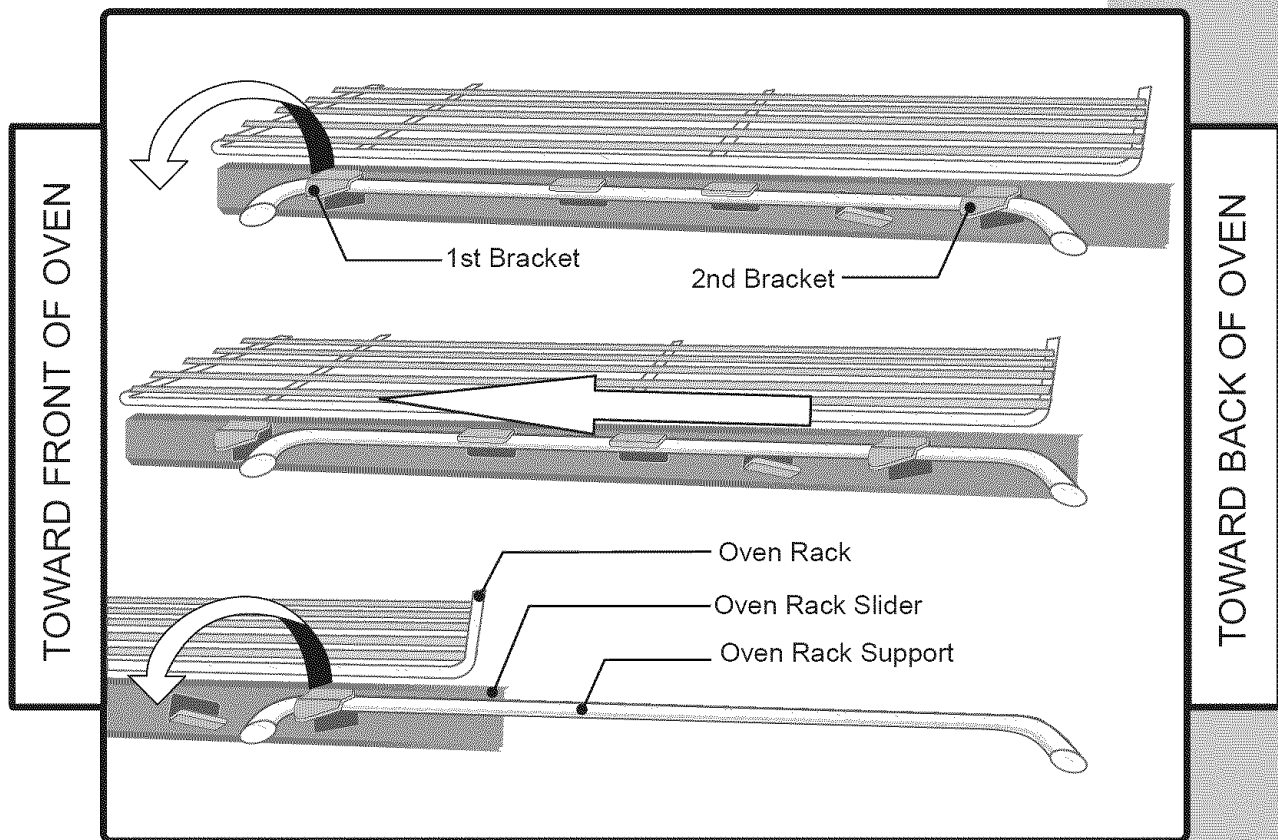

### Removing Non-Sliding Oven Racks

Simply pull the rack and slightly tilt it upward when the rack hits its stop position.

### Replacing Non-Sliding Oven Racks

Insert the rack into the oven rack supports by inserting the rack openings into the rack supports. Be sure the rack is at the same position on each oven rack support on both sides.

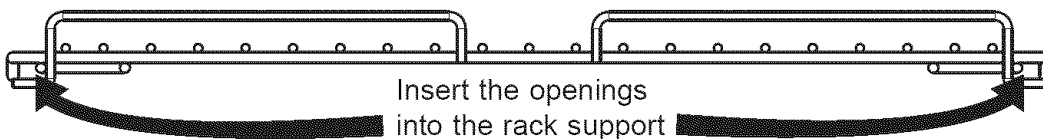

**⚠ WARNING** Always arrange the oven racks when the oven is cool (prior to operating the oven). Always use oven mitts when using the oven.

# 10 Feature Overview

## CONTROL PAD FUNCTIONS

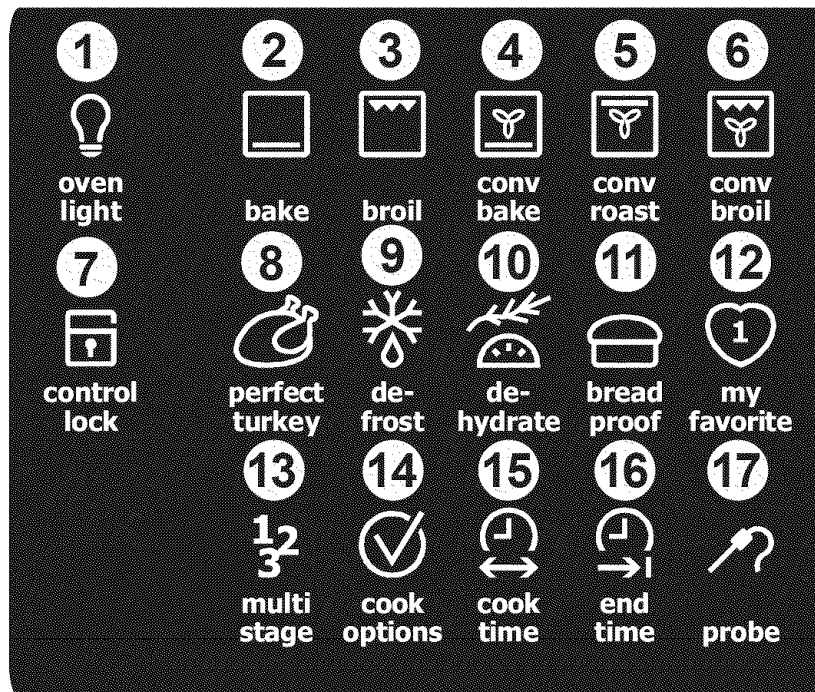

- 1** Light Pad- Used to turn the oven light on and off.
- 2** Bake Pad- Used to enter the normal baking mode temperature.
- 3** Broil Pad- Used to select the variable broil mode.
- 4** Convection Bake Pad- Used to select the convection baking mode.
- 5** Convection Roast Pad- Used to select the convection roasting mode.
- 6** Convection Broil Pad- Used to select the convection broil mode.
- 7** Control Lock Pad- Used to disable all oven function.
- 8** Perfect Turkey Pad- Used to select the perfect turkey cooking mode.
- 9** Defrost Pad- Used to select the defrost mode.
- 10** Dehydrate Pad- Used to select the dehydrate mode.
- 11** Bread Proof Pad- Used to select the bread proof mode.
- 12** My Favorite 1 Pad- Used to save or recall the favorite 1 cooking mode.
- 13** Multi Stage Pad- Used to enter up to three subsequent modes.
- 14** Cook Options Pad- Used to light up the cooking options pads.
- 15** Cook Time Pad- Used to set a cooking duration time.
- 16** End Time Pad- Used to select the time at which the cooking will end.
- 17** Probe Pad- Used to activate the meat probe mode.

## CONTROL PAD FUNCTIONS (CONTINUED)

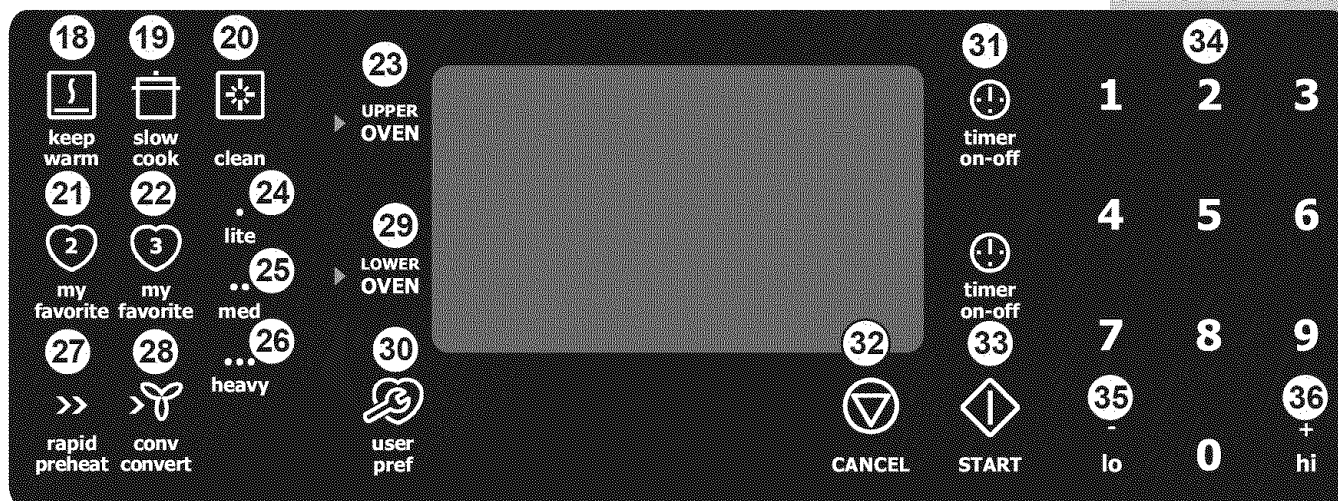



- 18** Keep Warm Pad- Used to select the keep warm mode.
- 19** Slow Cook Pad- Used to select the slow cook mode.
- 20** Clean Pad- Used to select the self-cleaning mode.
- 21** My Favorite 2 Pad- Used to save or recall the favorite 2 cooking mode.
- 22** My Favorite 3 Pad- Used to save or recall the favorite 3 cooking mode.
- 23** Upper Oven Pad- Used to activate the upper oven for cooking operation.
- 24** Lite Pad- Used to start a 2 hours self-clean cycle.
- 25** Med Pad- Used to start a 3 hours self-clean cycle.
- 26** Heavy Pad- Used to start a 4 hours self-clean cycle.
- 27** Rapid Preheat Pad- Used to preheat the oven to the desired temperature.
- 28** Conv. Convert Pad- Used to convert a standard temperature to a convection temperature.
- 29** Lower Oven Pad- Used to activate the lower oven for cooking operation.
- 30** User Preference Pad- Used to bring the user preference menu in the display.
- 31** Timer Pads- Used to set or cancel the minute timer. The minute timer does not start or stop cooking.
- 32** Cancel Pad- Used to cancel any function previously entered except the time of day and minute timer. Push **Cancel pad** to stop cooking.
- 33** Start Pad- Used to start all oven functions.
- 34** 0 Thru 9 Number Pads- Used to enter temperature and times.
- 35** - lo Pad- Used to lower the temperature and times.
- 36** + hi Pad- Used to raise the temperature and times.

# 12 Getting Started

## SETTING CLOCK AT POWER UP

When the unit is first plugged in, or when the power supply to the range has been interrupted, the timer in the display will flash with "12:00". The clock cannot be set when the oven is on. If an invalid time of day is entered, the control will triple beep to prompt you to re-enter a valid time of day.

### To set the clock (example for 1:30):

1. Press **1** **3** **0** pads to set the time of day to 1:30. The pads  $\overset{+}{hi}$  or  $\overset{-}{lo}$  can also be pressed to raise or lower the actual time displayed.
2. Press **START**  to accept the changes or **CANCEL**  to start with a time of 12:00.

## CONTROL PANEL DISPLAY MODES

### Sleep Mode:

Your control will remain in a sleep mode when not in use. Only the clock will display during this mode. You will need to wake the control to begin any function.

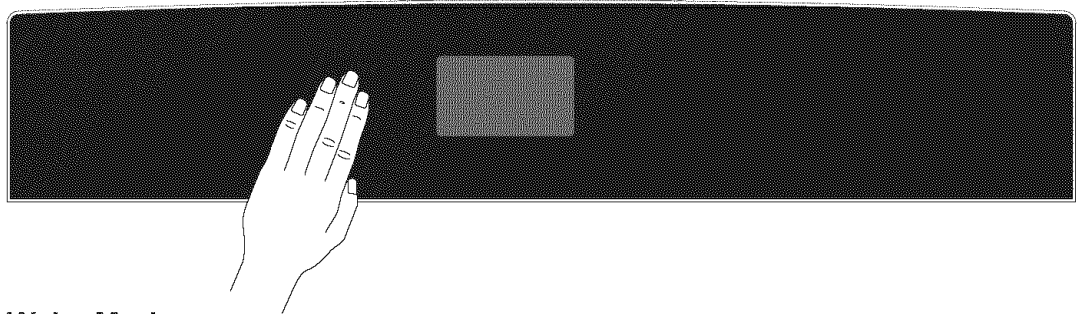

### Wake Mode:

To wake the control, touch within the display panel. After 2 minutes without activity the control will beep and go back into sleep mode.

To start a cooking feature you must select either the upper oven or the lower oven. User preferences will be available during this mode as well as timers, oven light and the control lock.

## TEMPERATURE VISUAL DISPLAY

Your oven is equipped with a temperature visual display for each oven. When a cooking mode is set, the actual temperature will be shown in the display and will rise as the unit preheats. When the unit has reached its target temperature, a chime will sound to remind you to place the food in the oven. This feature will be active with some cooking modes; bake, convection bake, convection roast and perfect turkey. The cooking modes which does not feature the temperature visual display will be noted in their descriptions.

NOTE: The lowest temperature that can be displayed is 100°F.

## OVEN LIGHT

Your appliance includes "theater" style oven lighting feature that gradually lights both the upper and lower oven interiors to full brightness. Each oven is equipped with 2 halogen lights. The oven lights will turn on automatically when the oven door is opened. The oven light may be turned on when the door is closed by using the oven light pad located on the control panel. The oven light key will toggle the lights in both ovens at the same time.



### To toggle the Oven Lights ON and OFF:

1. Press **OVEN LIGHT** .

## CONTROL LOCK

The Control Lock feature automatically locks the oven door and the control panel. The Control Lock is only allowed when the oven is turned OFF (not active). The Control Lock feature will lock both oven at the same time. **DOOR LOCK** will flash in the display for 20 seconds or until the door has finished locking. Once the door has been locked, **DOOR LOCK** will remain static. Do not attempt to open to oven door while **DOOR LOCK** is flashing.



### To toggle the Control Lock ON and OFF:





1. Keep **CONTROL LOCK**  pressed for 3 seconds.

## SETTING THE KITCHEN TIMER

This unit is equipped with 2 Kitchen Timers which serves as extra timers in the kitchen that will beep when the set time has run out. It does not start or stop cooking. The Timer feature can be used during any of the other oven control functions and cooking modes.



### To set the Timer (example for 5 minutes):

1. Press **TIMER** . "00:00" will appear in the display.
2. Press **5** pad to set the timer to 5 minutes. The pads  $_{hi}^{+}$  or  $_{lo}^{-}$  can also be pressed to raise or lower the actual time displayed.
3. Press again **TIMER**  to accept and start the countdown.
4. When the set time has run out, "00:00" will be displayed and the **TIMER**  pad will flash. The clock will sound a chime that will be repeated at regular intervals until the **TIMER**  pad is pressed.

### To cancel the Timer before the set time has run out:

Press **TIMER** . The display will return to the time of day.

# 14 Cooking Modes

## BAKING



This mode is best used for your standard recipes. The hidden bake element is used to heat the air and maintain temperature. The temperature probe can be used in this cooking mode. The oven can be programmed to bake at any temperature from 170°F to 550°F with a default temperature of 350°F.



### Baking Tips:

- Always preheat your oven before using the bake mode.
- During preheat, the 3 elements and the convection fan are used in cycle to quickly heat the oven.
- Use only one rack and center the pans as much as possible.
- If using two racks, place the oven racks in positions 2 and 6.
- Allow 2" to 4" (5,1 to 10,2cm) around the utensil(s) for proper air circulation.
- Be sure the pans do not touch each other, the door, sides or back of the oven.

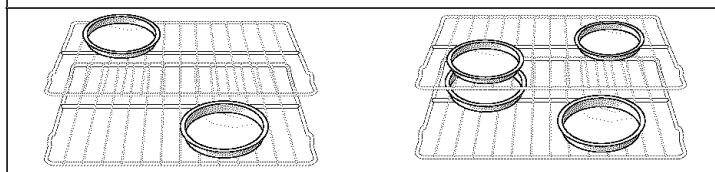
**If using multiple pans or racks, stagger as shown.**



### To set a Bake Temperature of 350°F:

1. Arrange interior oven racks.
2. Select oven by pressing either **UPPER OVEN** <sup>UPPER</sup> <sub>OVEN</sub> or **LOWER OVEN** <sup>LOWER</sup> <sub>OVEN</sub>.
3. Press **BAKE** .
4. Press **START** . The oven display shows **PRE-HEATING**.
5. Place food in the oven when the chime signals and temperature display shows that the oven has reached the set target temperature and the **PRE-HEATING** message disappear.
6. The Temperature Probe, Cook Time, Timer, End Time and Rapid Preheat features can be set to control your cooking time (read their sections for directions).
7. Remove food. Always use oven mitts when removing hot pans from the oven.
8. Press **CANCEL**  to stop or cancel the Bake feature at any time.

### To change to a Bake Temperature of 425°F:

1. Select the active oven by pressing either **UPPER OVEN** <sup>UPPER</sup> <sub>OVEN</sub> or **LOWER OVEN** <sup>LOWER</sup> <sub>OVEN</sub>.
2. Press the **HI** <sup>+</sup> <sub>hi</sub> or **LO** <sub>lo</sub> pads to get to the desired temperature.
3. Press **START** .

### Baking Problems

Refer to the Baking Problems Table in the Solutions to Common Problems section of this manual.

## COOK TIME

Cook Time allows the oven to be set to cook for a set length of time and shut off automatically. The time remaining will always be shown in the timer section of the display. The oven will shut off and will beep when the countdown is finished. This feature can be used with Bake, Convection Bake, Convection Roast, Slow Cook, Keep Warm, Defrost, Bread Proof, Dehydrate and Perfect Turkey cooking modes. It can also be part of a Multi-Stage sequence.



**To set a timed cooking** (example is a 450°F Bake for 30 minutes):

1. Select oven by pressing either **UPPER OVEN** UPPER OVEN or **LOWER OVEN** LOWER OVEN.
2. Press **BAKE** . The temperature numbers will blink in the display.
3. Enter temperature needed; **4 5 0**.
4. Press **COOK OPTIONS** to bring up the cook options items.
5. Press **COOK TIME** .
6. Enter time needed; **3 0**.
7. Press **START** . The oven will start heating. The cook time will start counting down for the set time.
8. Press **CANCEL** to stop the audible alarm or to cancel the cook time at anytime.

## END TIME

End Time allows the oven to be set to shut off automatically at a set time of day. The oven control will calculate the remaining time by itself. The time remaining will always be shown in the timer section of the display. The oven will shut off and will beep when the countdown is finished. This feature can be used with Bake, Convection Bake, Convection Roast, Slow Cook, Keep Warm, Defrost, Dehydrate, Clean and Bread Proof cooking modes. This oven can be programmed with Cook Time and End Time to start and stop by itself at the right time.



**To set a delayed timed cooking** (example is a 450°F Bake for 30 minutes which will end at 6:00PM):

1. Select oven by pressing either **UPPER OVEN** UPPER OVEN or **LOWER OVEN** LOWER OVEN.
2. Press **BAKE** . The temperature numbers will blink in the display.
3. Enter temperature needed; **4 5 0**.
4. Press **COOK OPTIONS** to bring up the cook options items.
5. Press **COOK TIME** .
6. Enter time needed; **3 0**.
7. Press **END TIME** .
8. Enter time of day needed; **6 0 0**.
9. Press **START** . The time remaining will be shown in the display.
10. Press **CANCEL** to stop the audible alarm or to cancel the end time at anytime.

**CAUTION** Use caution with the **COOK TIME** or **END TIME** features. Use the automatic timer when cooking cured or frozen meats and most fruits and vegetables. Foods that can easily spoil such as milk, eggs, fish, meat or poultry, should be chilled in the refrigerator first. Even when chilled, they should not stand in the oven for more than 1 hour before cooking begins, and should be removed promptly when cooking is completed. Eating spoiled food can result in sickness from food poisoning.

# 16 Cooking Modes

## BROILING





This mode is best for meats, fish and poultry up to 1" thick. Broiling is a method of cooking tender cuts of meat by direct heat under the broil element of the oven. The high heat cooks quickly and gives a rich, brown outer appearance. The temperature probe cannot be used with this mode. The oven can be programmed to broil at any temperature from 300°F to 550°F with a default temperature of 550°F.

### Broiling Tips:

- For optimum browning, preheat the broil element for 2 minutes.
- Broil one side until the food is browned; turn and cook on the second side. Season and serve.
- Always pull the rack out to the "stop" position before turning or removing food.
- Always use the broiler pan and its grid when broiling. It allows the dripping grease to be kept away from the high heat of the broil element (see Figure 1).
- For best broiling results, broil with the oven door slightly open.
- **DO NOT** use the broil pan without the insert. **DO NOT cover the broil pan insert with foil.** The exposed grease could catch fire. **DO NOT** use the roasting rack when broiling.

### To set a Broil Temperature of 550°F:

1. Arrange interior oven racks.
2. Select oven by pressing either **UPPER OVEN** <sup>UPPER</sup>OVEN or **LOWER OVEN** <sup>LOWER</sup>OVEN.
3. Press **BROIL** .
4. Press **START** .
5. Place food in the oven after 2 minutes.
6. Turn food when the top side is browned and cook on the second side.
7. Remove food. Always use oven mitts when removing hot pans from the oven.
8. Press **CANCEL**  to stop or cancel the Broil feature at any time.

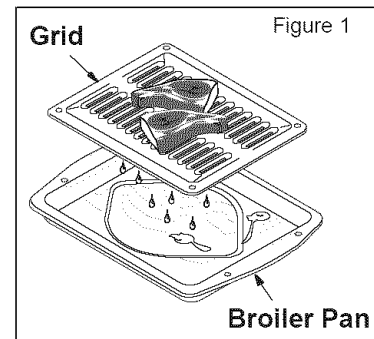

### Broiling Times

Food Item	Rack Position	Temp Setting	Cook Time		Doneness
			1st side	2nd side	
Steak 1" thick	7	550° F	6:00	4:00	Rare
	7	550° F	7:00	5:00	Medium
Pork Chops 3/4" thick	7	550° F	8:00	6:00	Well
Chicken - Bone In	5	450° F	20:00	10:00	Well
Chicken - Boneless	7	450° F	8:00	6:00	Well
Fish	7	500° F	13:00	0:00	Well
Shrimp	5	550° F	5:00	0:00	Well
Hamburger 1" thick	7	550° F	9:00	7:00	Medium
	5	550° F	10:00	8:00	Well

**WARNING** Should an oven fire occur, close the oven door and turn off the oven. If the fire continues, throw baking soda on the fire or use a fire extinguisher. **DO NOT** put water or flour on the fire. Flour may be explosive and water can cause a grease fire to spread and cause personal injury.

## CONVECTION BAKING

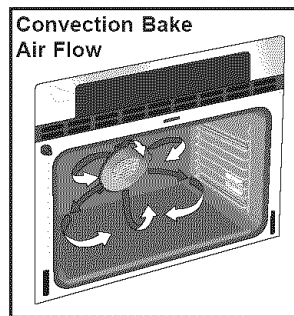

This mode of cooking enables you to obtain the best culinary results when baking with multiple pans and racks. Multiple rack baking may slightly increase cook time for some foods but the overall result is time saved. Most foods cooked in a standard oven will cook faster and more evenly with Convection Bake. Convection baking uses the three elements and a fan to circulate the oven's heat evenly and continuously within the oven. The temperature probe can be used in this cooking mode. The oven can be programmed for Convection baking at any temperature between 170°F to 550°F with a default temperature of 350°F.



### Convection Baking Tips:

- Always preheat your oven before using the Convection Bake mode.
- If your recipe cooking temperature has already been converted for convection baking there is no need to reduce your oven temperature. If your recipe has not had the temperature converted for convection baking you can easily reduce using the Convection Convert feature. Please see Convection Convert section on next page for further instruction on temperature conversion.
- Use tested recipes with times adjusted for convection baking when using this mode. With single rack convection baking the some foods may have as much as a 25% reduction in cook time, check food at minimum time. Time reductions will vary depending on the amount and type of food to be cooked.
- When using Convection Bake with a single rack, place oven rack in position 3 or 4. If cooking on multiple racks, place the oven racks in positions 2 and 6 or 1, 4 and 7.
- Most bakeries (except cakes) should be baked on pans with no sides or very low sides to allow heated air to circulate around the food.
- Food baked on pans with a dark finish will cook faster.

### To set a Convection Bake Temperature of 350°F:

1. Arrange interior oven racks.
2. Select oven by pressing either **UPPER OVEN** UPPER OVEN or **LOWER OVEN** LOWER OVEN.
3. Press **CONVECTION BAKE** .
4. Press **START** . The oven display shows **PRE-HEATING**.
5. Place food in the oven when the chime signals and temperature display shows that the oven has reached the set target temperature and the **PRE-HEATING** message disappear.
6. The Temperature Probe, Cook Time, Timer, End Time and Rapid Preheat features can be set to control your cooking time (read their sections for directions).
7. Remove food. Always use oven mitts when removing hot pans from the oven.
8. Press **CANCEL**  to stop or cancel the Convection Bake feature at any time.

# 18 Cooking Modes





## CONVECTION CONVERT



The Convection Convert pad is used to automatically convert a standard baking recipe for convection baking. When set properly, this feature is designed to display the actual converted (reduced) temperature in the display. Convection Convert may ONLY be used with a Convection Bake cooking mode. It can be used with the features End Time and Cook Time (see their sections for directions). If convection conversion is used with the cook time and end time features, "CF" (check food) will be displayed when 75% of the bake time complete. At this time the oven control will sound 3 long beeps at regular intervals until baking had finished. When the bake time has completely finished the control will beep at regular interval until the CANCEL  pad is pressed.

**NOTE:** To use this feature with the COOK TIME  option, the COOK TIME  pad must be pressed before the CONVECTION CONVERT  pad.

### Changing from a normal bake temperature to a convection bake temperature:

1. Select oven by pressing either UPPER OVEN <sup>UPPER</sup>OVEN or LOWER OVEN <sup>LOWER</sup>OVEN.
2. Press CONVECTION BAKE .
3. Press COOK OPTIONS . The cook options items will light up.
4. Press CONVECTION CONVERT . The temperature displayed will be 25°F lower than what it used to be.
5. Press START  to begin the convection baking (see Convection Baking section for more informations).





## RAPID PREHEAT



The Preheat feature will bring the oven up to temperature faster than a regular preheat and then indicate when to place the food in the oven. Preheating is not necessary when roasting or cooking casseroles. The oven can be programmed to preheat at any temperature between 170°F to 550°F with some of the cooking modes; Bake, Convection Bake and Convection Roast.

**IMPORTANT:** The rapid preheat feature is for single rack ONLY. The heat distribution with multiple rack will be uneven.

### To set a rapid preheat (example is for a 350°F Bake):

1. Select oven by pressing either UPPER OVEN <sup>UPPER</sup>OVEN or LOWER OVEN <sup>LOWER</sup>OVEN.
2. Press BAKE .
3. Press COOK OPTIONS . The cook options items will light up.
4. Press RAPID PREHEAT .
5. Press START  to begin the baking with the rapid preheat feature enabled.
6. Place food in the oven when the chime signals and PRE-HEATING message disappears indicating that the oven has reached the set target temperature.

## CONVECTION ROASTING

This mode is best for cooking tender cuts of beef, lamb, park and poultry. Use this mode when cooking speed is desired. The Convection Roasting gently browns the exterior and seals in the juices. Convection roasting uses the hidden bake element, the hidden convection element, the broil element and a fan to circulate the oven's heat evenly and continuously within the oven. The temperature probe can be used in this cooking mode. The oven can be programmed for Convection Roasting at any temperature between 170°F to 550°F with a default temperature of 350°F.



### Convection Roasting Tips:

- Use the broiler pan and grid, and the roasting rack (Figure 1). The broiler pan will catch grease spills and the grid will help prevent spatters. The roasting rack will hold the meat.
- Place an oven rack on rack position 2 (next-bottom).
- Make sure the roasting rack is securely seated on the grid in the broiler pan. The roasting rack fits on the grid allowing the heated air to circulate under the food for even cooking and helps to increase browning on the underside.
- There is no need to reduce the convection temperature or to use the Convection Convert feature with this cooking mode.
- **DO NOT** use the broiler pan without the grid or cover the grid with aluminum foil.
- Always pull the rack out to the stop position before removing food.
- Position food (fat side up) on the roasting rack.

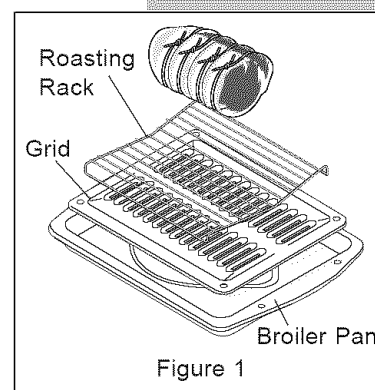





Figure 1

### To set a Convection Roast Temperature of 350°F:

1. Arrange interior oven racks.
2. Select oven by pressing either **UPPER OVEN** UPPER OVEN or **LOWER OVEN** LOWER OVEN.
3. Press **CONVECTION ROAST** .
4. Press **START** .
5. The Temperature Probe, Cook Time, Timer, End Time and Rapid Preheat features can be set to control your cooking time (read their sections for directions).
6. Remove food. Always use oven mitts when removing hot pans from the oven.
7. Press **CANCEL**  to stop or cancel the Convection Roast feature at any time.

Convection Roasting Chart					
Meat		Weight	Oven Temp	Internal Temp	Min per lb.
Beef	Standing rib roast	4 to 6 lbs.	350° F	*	25-30
	Rib eye roast	4 to 6 lbs.	350° F	*	25-30
	Tenderloin roast	2 to 3 lbs.	400° F	*	15-25
Poultry	Turkey, whole**	12 to 16 lbs.	325° F	180° F	8-10
	Turkey, whole**	16 to 20 lbs.	325° F	180° F	10-15
	Turkey, whole**	20 to 24 lbs.	325° F	180° F	12-16
	Chicken	3 to 4 lbs.	350-375° F	180° F	12-16
Pork	Ham roast, fresh	4 to 6 lbs.	325° F	160° F	30-40
	Shoulder blade roast	4 to 6 lbs.	325° F	160° F	20-30
	Loin	3 to 4 lbs.	325° F	160° F	20-25
	Pre-cooked ham	5 to 7 lbs.	325° F	160° F	30-40

\* For beef: med rare 145°F, med 160°F, well done 170°F

\*\* Stuffed turkey requires additional roasting time. Shield legs and breast with foil to prevent overbrowning and drying of the skin.

# 20 Cooking Modes

## CONVECTION BROILING



Use this mode for thicker cuts of meat, fish and poultry. The Convection Broiling gently browns the exterior and seals in the juices. Convection broiling uses the broil element and a fan to circulate the oven's heat evenly and continuously within the oven. The temperature probe cannot be used in this cooking mode. The oven can be programmed for Convection Broiling at any temperature between 300°F to 550°F with a default temperature of 550°F.



### Convection Broiling Tips:

- For optimum browning, preheat the broil element for 2 minutes.
- Broil one side until the food is browned; turn and cook on the second side. Season and serve.
- Always pull the rack out to the "stop" position before turning or removing food.
- Always use the broiler pan and its grid when broiling. It allows the dripping grease to be kept away from the high heat of the broil element (see Figure 1).
- **DO NOT** use the broil pan without the insert. **DO NOT cover the broil pan insert with foil.** The exposed grease could catch fire. **DO NOT** use the roasting rack when broiling.
- Convection broiling is generally faster than conventional broiling. Check for doneness at the minimum recommended time.

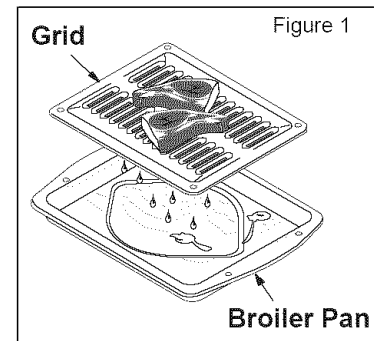
**IMPORTANT:** Always use this cooking mode with the oven door closed or the fan will not turn on.



### To set a Convection Broil Temperature of 550°F:

1. Arrange interior oven racks.
2. Select oven by pressing either **UPPER OVEN** UPPER OVEN or **LOWER OVEN** LOWER OVEN.
3. Press **CONVECTION BROIL** .
4. Press **START** .
5. Place food in the oven after 2 minutes.
6. Turn food when the top side is browned and cook on the second side.
7. Remove food. Always use oven mitts when removing hot pans from the oven.
8. Press **CANCEL**  to stop or cancel the Convection Broil feature at any time.

**WARNING** Should an oven fire occur, leave the oven door closed and turn off the oven. If the fire continues, throw baking soda on the fire or use a fire extinguisher. **DO NOT** put water or flour on the fire. Flour may be explosive and water can cause a grease fire to spread and cause personal injury.

## KEEP WARM

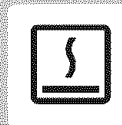

This mode is best for keeping oven baked foods warm for serving after cooking has finished. The Keep Warm feature uses the hidden bake element to maintain the temperature within the oven. The Keep Warm feature may be used with Multi-Stage (refer to its section for directions) if you wish to have the Keep Warm feature turn ON automatically when cooking has finished. The oven can be programmed for Keep Warm at any temperature between 150°F to 190°F with a default temperature of 170°F.



### Keep Warm Tips:

- Always start with hot food.
- Do not use the Keep Warm feature to heat cold food.
- Food in heat-safe glass and glass ceramic containers may need higher temperature settings compared to food in regular containers.
- Avoid repeated openings of the oven, it will allow hot air to escape and the food to cool.
- Aluminum foil may be used to cover food to increase moisture content.

### To set a Warm Keep Temperature of 170°F:

1. Arrange interior oven racks.
2. Select oven by pressing either **UPPER OVEN** UPPER OVEN or **LOWER OVEN** LOWER OVEN.
3. Press **KEEP WARM** .
4. Press **START** .
5. The Multi-Stage, Cook Time, Timer and End Time features can be set to control your warming time (read their sections for directions).
6. Remove food. Always use oven mitts when removing hot pans from the oven.
7. Press **CANCEL**  to stop or cancel the Keep Warm feature at any time.

# 22 Cooking Modes

## SLOW COOK

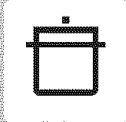



This mode may be used to cook foods more slowly, at lower oven temperatures and provide cooking results much the same way as a Slow Cooker or Crock-Pot. The Slow Cook feature is ideal for roasting beef, pork & poultry. Slow Cooking meats may result in the exterior of meats becoming dark but not burnt. This is normal. The Slow Cook mode uses the hidden bake element to maintain a low temperature in the oven. The temperature probe cannot be used in this cooking mode. There are 2 settings available, high (HI) or low (LO). The maximum cook time for the Slow Cook feature is 12 hours unless the oven control has been changed to the Continuous Bake mode.

### Slow Cook Tips:

- Completely thaw all frozen foods before cooking with the Slow Cook feature.
- When using a single rack, position it in the center of the oven.
- Position multiple racks to accommodate size of cooking utensils when cooking multiple food items.
- Do not open the oven door often or leave the door open when checking foods. If the oven heat escapes often, the Slow Cook time may need to be extended.
- Cover the foods to keep them moist or use a loose or vented type cover to allow foods to turn crisp or brown.
- Cook times will vary; depending on the weight, fat content, bone & the shape of the meat.
- Use the recipe's recommended food temperature and a food thermometer to determine when the food is done.
- Preheating the oven will not be necessary when using the Slow Cook feature.
- Add any cream or cheese sauces during the last hour of cooking.

### To set a Slow Cook:

1. Arrange interior oven racks and place food in the oven.
2. Select oven by pressing either **UPPER OVEN** UPPER OVEN or **LOWER OVEN** LOWER OVEN.
3. Press **SLOW COOK** .
4. Press  $\overset{+}{\text{hi}}$  for high (HI) setting or  $\overset{-}{\text{lo}}$  low (Lo) setting.
5. Press **START** .
6. The Cook Time, Timer and End Time features can be set to control your Slow Cook time (read their sections for directions).
7. Remove food. Always use oven mitts when removing hot pans from the oven.
8. Press **CANCEL**  to stop or cancel the Slow Cook feature at any time.

## DEHYDRATING



This mode dries foods with heat from the bake and the convection element. The heat is circulated throughout the oven by the convection fan. Dehydrating is used to dry and/or preserve foods such as fruits, meats, vegetables and herbs. This mode holds an optimum low temperature while circulating the heated air to slowly remove moisture. The oven can be programmed for Dehydrating at any temperature between 100°F to 225°F with a default temperature of 120°F.



### Dehydrating Tips:

- Do not preheat the oven.
- Multiple racks can be used simultaneously.
- Drying times vary depending on the moisture and sugar content of the food, the size of the pieces, the amount being dried and the humidity in the air.
- Check food at the minimum drying time.
- Treat fruits with antioxidants to avoid discoloration.
- Consult a food preservation book or a library for additional information.

### To set a Dehydrate Temperature of 120°F:



1. Arrange interior oven racks and place food.
2. Select oven by pressing either **UPPER OVEN** UPPER OVEN or **LOWER OVEN** LOWER OVEN.
3. Press **DEHYDRATE** .
4. Press **START**  to begin dehydrating.
5. Remove food. Always use oven mitts when removing hot pans from the oven.
6. Press **CANCEL**  to stop or cancel the Dehydrate feature at any time.

## DEFROSTING

Use the defrost feature to thaw small portions of delicate items such as cream cakes, frozen cream pies and cheesecake, at room temperature. While in the defrost mode, the convection fan will operate to circulate room temperature air around the food slowly, accelerating the natural defrosting of the food without heat.



### To set a Defrost:

1. Arrange interior oven racks and place food in the oven.
2. Select oven by pressing either **UPPER OVEN** UPPER OVEN or **LOWER OVEN** LOWER OVEN.
3. Press **DEFROST** .
4. Press **START**  to start the defrosting. A “dEF” message is displayed when active.
5. The Cook Duration, End Time and Timer features can be set to control your Defrost time (read their sections for directions).
6. Press **CANCEL**  to stop or cancel the Defrost feature at any time.

**Note:** This feature is not meant for thawing frozen meats, poultry, seafood or other foods that need to be cooked before serving. Follow USDA recommendations for thawing foods. Only frozen foods that can be defrosted and served without cooking should be used with this feature.

# 24 Cooking Modes

## BREAD PROOFING





Proofing bread prepares the dough for baking by activating the yeast. This feature is ideal for proofing, or rising bread dough. The oven can be programmed for Bread Proofing at any temperature between 85°F to 100°F with a default temperature of 100°F.

### Bread Proofing Tips:

- No need to preheat for this feature.
- Proof bread until dough has doubled in bulk.
- For best results, place a shallow pan with 1 to 3 cups of boiling hot water on the lowest rack position to keep the air moist inside the oven cavity.
- Allow at least 1" between edge of pan and walls of the oven.
- Limit frequent door openings to prevent losing heat and lengthening proofing time.

### To set a Bread Proof temperature of 100°F:

1. Arrange interior oven racks and place bread dough in the oven.
2. Select oven by pressing either **UPPER OVEN** UPPER OVEN or **LOWER OVEN** LOWER OVEN.
3. Press **BREAD PROOF** .
4. Press **START**  to begin the bread proofing.
5. The Cook Time, Timer and End Time features can be set to control your Bread Proof time (read their sections for directions).
6. Remove food.
7. Press **CANCEL**  to stop or cancel the Bread Proof feature at any time.

### To change a Bread Proof temperature while the function is active:

1. Select oven by pressing either **UPPER OVEN** UPPER OVEN or **LOWER OVEN** LOWER OVEN.
2. Press the **HI** hi <sup>+</sup> or **LO** lo <sup>-</sup> pads to get to the desired temperature.
3. Press **START**  to continue the bread proofing with the new setting.

## PERFECT TURKEY

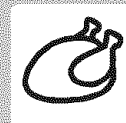



This mode uses the temperature probe to control precisely the cooking of a perfect turkey. The convection system gently browns the turkey's exterior and seals in the juices. The temperature probe is **required** with this cooking mode (read its section on next page for more details). The oven can be programmed for Perfect Turkey at any temperature between 170°F to 550°F with a default temperature of 325°F. The probe default temperature for the perfect turkey feature is 180°F.



### Perfect Turkey Tips:

- Thaw the turkey in the refrigerator at least 24 hours per 5 lbs before cooking the bird.
- Do not preheat your oven before using the Perfect Turkey mode.
- Use the broiler pan and grid, and the roasting rack. The broiler pan will catch grease spills and the grid will help prevent spatters. The roasting rack will hold the turkey.
- Place an oven rack on rack position 2 (next-bottom).
- Make sure the roasting rack is securely seated on the grid in the broiler pan. The roasting rack fits on the grid allowing the heated air to circulate under the food for even cooking and helps to increase browning on the underside.

### To set a Perfect Turkey:

1. Arrange interior oven racks and place food in the oven.
2. Insert the meat probe into the bird and connect it in the oven (read the probe section on next page for more details).
3. Select oven by pressing either **UPPER OVEN** UPPER OVEN or **LOWER OVEN** LOWER OVEN.
4. Press **PERFECT TURKEY** . A temperature can be entered if another value than the default is needed.

Optional : Press **PROBE**  if you wish to change the probe target temperature (see PROBE section).

5. Press **START** .
6. Remove food from the oven when the probe chime signals that the bird internal temperature has reached its target temperature.
7. Press **CANCEL**  to stop or cancel the Perfect Turkey feature at any time.

Perfect Turkey Chart		Weight	Oven Temp	Internal Temp	Min per lb.
Poultry	Turkey, whole*	12 to 16 lbs.	325° F	180° F	8-10
	Turkey, whole*	16 to 20 lbs.	325° F	180° F	10-15
	Turkey, whole*	20 to 24 lbs.	325° F	180° F	12-16
	Chicken	3 to 4 lbs.	350-375° F	180° F	12-16

\* Stuffed turkey requires additional roasting time. Shield legs and breast with foil to prevent overbrowning and drying of the skin.

# 26 Cooking Modes

## TEMPERATURE PROBE



For many foods, especially roasts and poultry, testing the internal temperature is the best method to insure properly cooked food. The Temperature Probe gets the exact temperature you desire without having to guess. This feature can be used with Bake, Convection Bake, Convection Roast and Perfect Turkey cooking modes. The oven can be programmed for Probe at any temperature between 130°F to 210°F with a default temperature of 170°F. This unit is equipped with one temperature probe entry in each oven.

### IMPORTANT:

1. Use only the probe supplied with your appliance; any other may result in damage to the probe or the appliance.
2. Handle the Temperature Probe carefully when inserting and removing it from the food and outlet.
3. Do not use tongs to pull the cable when inserting or removing the Probe. It could damage the Probe.
4. Defrost your food completely before inserting the Probe to avoid breaking it.
5. Never leave or store the Temperature Probe inside the oven when not in use.
6. To prevent the possibility of burns, carefully unplug the Temperature Probe using hot pads.

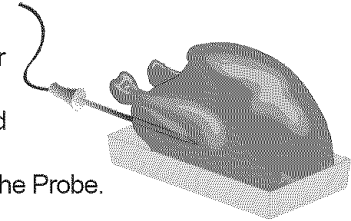







Figure 1

### Proper Temperature Probe Placement:

1. Always insert the probe so that the tip rests in the center of the thickest part of the meat. Do not allow probe to touch bone, fat, gristle or pan.
2. For bone-in ham or lamb, insert the Probe into the center of the lowest large muscle or joint. For dishes such as meat loaf or casseroles, insert the Probe into the center of the food. When cooking fish, insert the Probe from just above the gill into the meatiest area, parallel to the backbone.
3. For whole poultry (chicken, turkey, etc.), insert the probe into the thickest part of the inner thigh from below and parallel to the leg (see figure 1).

### Setting the Oven when using the Temperature Probe:

1. Insert the Temperature Probe into the food (see Proper Temperature Probe Placement above).
2. Plug the Temperature Probe into its outlet in the oven. (**The outlet is located on the top left hand side of the cavity wall, near front of the oven**). Always insert the probe into a cool oven. Make sure it is pushed all the way into the outlet. Close the oven door.
3. Select oven by pressing either **UPPER OVEN** UPPER OVEN or **LOWER OVEN** LOWER OVEN.
4. Select a cooking mode. A target temperature must be set to trigger the buzzer when the food reaches the set temperature. Press **COOK OPTIONS**  to bring up the cook options items and press **PROBE**  pad to enter the temperature. Adjust temperature to the desired setting using the numeric pads or just press **START**  to use the default target temperature of 170°F. The pads **+** hi or **-** lo can also be pressed to raise or lower the temperature. The target temperature setting will be accepted after the **START**  pad is pressed.
5. At any time during the cooking, the **PROBE**  pad can be pressed once to display the actual meat temperature or pressed twice to display the target temperature. When on the target temperature display, a new temperature can be entered. After 5-8 seconds, the display will go back to showing the oven temperature.
6. When the food reach the target temperature, the oven will go into a **KEEP WARM** mode until you press **CANCEL** .

The probe can be damaged by very high temperature. To protect the probe against this damage, the oven control will not allow you to start a self-clean, broil or convection broil while the probe is connected.

## MULTI STAGE



1  
2  
3

This feature enables you to perform sequential cooking at the touch of a button. Its purpose is to program a queue of up to three cooking modes with individual cooking time and temperatures in a sequence. This feature can be used with most cooking modes; Baking, Broiling, Convection Baking, Convection Roasting, Convection Broiling, Keep Warm and Bread Proof. A Cook Time can be programmed with your cooking mode and then queued. An auto-suggested set temperature outputs in the display as a default value during the set temperature programming. Any stage programmed with Broil or Convection Broil cannot last longer than 10 minutes. A proper cook time and a set temperature are required for every stage programming. At least two stages must be programmed before a Multi-Stage cooking operation starts. During stage 1 cooking the electronic control provides temperature visual output in the display. During stage 2 and 3, the electronic control displays the set temperature only.





### To set a Multi Stage sequence (Timed Convection Bake, Timed Broil, Keep Warm):

1. Arrange interior oven racks and place food.
2. Select oven by pressing either **UPPER OVEN** UPPER OVEN or **LOWER OVEN** LOWER OVEN.
3. Press **MULTI STAGE** .

#### Stage 1

4. Press **CONVECTION BAKE** . "350" will flash in the display prompting to enter a temperature.
5. Enter a temperature using the numeric pads **0** to **9**.
6. Press **START** . "00:00" will start flashing in the display prompting to enter a cook time.
7. Enter a cook time using the numeric pads **0** to **9**.
8. Press **START** . The Multi-Stage indicator will now display the 2nd stage.

#### Stage 2

9. Press **BROIL** . "550" will start flashing in the display prompting to enter a temperature.
10. Enter a temperature using the numeric pads **0** to **9**.
11. Press **START** . "00:00" will start flashing in the display prompting to enter a cook time.
12. Enter a cook time using the numeric pads **0** to **9**.
13. Press **START** . The Multi-Stage indicator will now display the 3rd stage. If a third stage is not needed, press **START**  a second time. This will start the cooking sequence.



Read next page for stage 3 and canceling details

# 28 Cooking Modes

## MULTI STAGE (CONTINUED)

12  
3

### Stage 3

14. Press **KEEP WARM** . "170" will start flashing in the display prompting to enter a temperature.
15. Enter a temperature using the numeric pads **0** to **9**.
16. Press **START** . "00:00" will start flashing in the display prompting to enter a cook time.
17. Enter a cook time using the numeric pads **0** to **9**.
18. Press **START** . The cooking sequence will begin.

### Canceling

19. At the end of the sequence, the display will show "End" and a chime will sound.
20. Remove food.
21. Press **CANCEL**  to stop or cancel the Multi-Stage sequence at any time (see below for further details).

### To cancel a Multi Stage sequence:

A multi stage cooking can be canceled any time while it is in progress (or during its programming) by the Cancel  key.

If the key is pressed during a multi-stage programming, the electronic control returns to Idle mode.





## USER PREFERENCES

---



The user preferences menu includes all user defined options. This feature enables you to control the various options of the electronic controls. This menu features the Time of Day, Celsius or Fahrenheit display mode, Continuous Bake or 12 Hour Energy Saving modes, Clock display or No-Clock display, 12 Hours Time of Day or 24 Hours Time of Day, Audio Control and Adjusting the oven temperature. The User Preferences menu is only available when the oven is not being used (not cooking).

### To browse through the User Preferences menu:

1. Press **USER PREF**  to bring up the User Preferences menu.
2. Press **USER PREF**  again to browse through the menu pages.
3. Press  $\overset{+}{hi}$  or  $\overset{-}{lo}$  to toggle between the available options.
4. Press **START**  while the chosen option is on display to change.
5. Press **CANCEL**  when finished to get back to the standard oven display.

### User Preferences menu items:



- **CLO 12:00**; Setting the clock.
- **CLO on**; Clock on/off.
- **CLO 12hr**; 12/24 hour time of day display.
- **UPO**; Adjusting oven temperature.
- **F-C F**; Fahrenheit / Celcius display.
- **AUd**; Audio on/off and volume.
- **E S on**; 12 hour Energy Saving on/off.
- **rSt** ; Reset to default factory settings.

## SETTING THE CLOCK - TIME OF DAY

The clock may be set for 12 or 24 hour time of day operation (see advanced settings section). The clock has been preset at the factory for the 12 hour operation. When the range is first plugged in, or when the power supply to the range has been interrupted, the display will show "**CLO 12:00**". The clock must be set before the oven can be used.

When power to the unit has been interrupted, to set the Clock, skip step 1 in the example below and follow steps 2 and 3.

### To set the clock (example for 1:30):

1. Press **USER PREF**  until you get to the **CLO 12:00** menu page.
2. Press **1 3 0** pads to set the time of day to 1:30. The pads  $\overset{+}{hi}$  or  $\overset{-}{lo}$  can also be pressed to raise or lower the actual time displayed.
3. Press **START**  to accept the changes and go back to user preferences menu display.

## USER PREFERENCES (CONTINUED)



### SETTING CLOCK DISPLAY — ON OR OFF

The oven control can be programmed to display the time of day or not. The oven has been preset at the factory to display the time of day.

#### Changing clock display between ON and OFF:

1. Press **USER PREF** until you get to the **CLO on** menu page.
2. Press  $\overset{-}{\text{lo}}$  or  $\overset{+}{\text{hi}}$  to toggle between displaying or hiding the clock.
3. Press **START** to accept the changes and go back to user preferences menu display.

### SETTING TIME OF DAY DISPLAY — 12 OR 24 HOURS

The oven control can be programmed to display time of day in 12 hours or 24 hours mode. The oven has been preset at the factory to display in 12 hours mode.

#### Changing between 12 or 24 hour time of day display:

1. Press **USER PREF** until you get to the **CLO 12hr** menu page.
2. Press  $\overset{-}{\text{lo}}$  or  $\overset{+}{\text{hi}}$  to toggle the display of the clock in 12 or 24 hours.
3. Press **START** to accept the changes and go back to user preferences menu display.
4. Remember to set your clock after changing the time of day display mode.

### ADJUSTING OVEN TEMPERATURE

The temperature in the oven has been pre-set at the factory. When first using the oven, be sure to follow recipe times and temperatures. If you think the oven is too hot or too cool, the temperature in the oven can be adjusted. Before adjusting, test a recipe by using a temperature setting that is higher or lower than the recommended temperature. The baking results should help you to decide how much of an adjustment is needed. Each oven can be individually adjusted.

#### To adjust the oven temperature:



1. Press **USER PREFERENCES** until you get to the  **UPO** menu page.
2. If you want to adjust the temperature in the lower oven, press **USER PREFERENCES** again.  **UPO** will appear in the lower display.
3. Enter the temperature by pressing the  $\overset{+}{\text{hi}}$  or  $\overset{-}{\text{lo}}$  pads. The temperature can only be adjusted by  $\pm 35^{\circ}\text{F}$ .
4. Press **START** to accept the changes and go back to user preferences menu display.

## USER PREFERENCES (CONTINUED)

### SETTING TEMPERATURE DISPLAY — FAHRENHEIT OR CELSIUS

The oven control can be programmed to display temperatures in Fahrenheit or Celsius. The oven has been preset at the factory to display in Fahrenheit.



#### To change display from Fahrenheit to Celsius or Celsius to Fahrenheit:

1. Press **USER PREF**  until you get to the **F-C F** menu page.
2. Press  $\overset{+}{hi}$  or  $\overset{-}{lo}$  to toggle between the °C and °F display options.
3. Press **START**  to accept the changes and go back to user preferences menu display.

### AUDIO CONTROL

The Audio Control feature allows the oven control to be operated without sounds or beeps whenever necessary. If desired the control can be programmed for silent operation and later returned to operating with all the default sounds and beeps. The volume of the beeps can also be adjusted.



#### To change the audio mode or audio volume:

1. Press **USER PREF**  until you get to the **AUd** menu page.
2. Press  $\overset{+}{hi}$  or  $\overset{-}{lo}$  to toggle between the available volume settings. **AUd 5** for the highest volume setting to **AUd 1** for the lowest volume. **AUd OFF** to disable the beeps.
3. Press **START**  to accept the changes and go back to user preferences menu display.

### SETTING CONTINUOUS BAKE OR 12 HOUR ENERGY SAVING

The oven control has a factory preset built-in 12 Hour Energy Saving feature that will shut off the oven if the oven control is left on for more than 11 hours and 59 minutes. The oven can be programmed to override this feature for Continuous Baking.



#### Changing between 12 hour energy saving and continuous bake:

1. Press **USER PREF**  until you get to the **E S** menu page.
2. Press  $\overset{+}{hi}$  or  $\overset{-}{lo}$  to toggle the energy saving setting on and off.
3. Press **START**  to accept the changes and go back to user preferences menu display.

### RESETTING TO DEFAULT FACTORY SETTINGS

The oven control can be set to return to its original factory settings. This includes: Setting the Clock ON/OFF to ON, Setting the clock display mode to 12h, Display mode to Fahrenheit, Setting the oven temperature adjustment to zero, Setting audio level to 5 and Enabling the 12h energy saving mode. Resetting the control also erases the My Favorite recipes.

#### To reset the oven control to its original settings:

1. Press **USER PREF**  until you get to the **rSt no** menu page.
2. Press  $\overset{+}{hi}$  or  $\overset{-}{lo}$  to select **YES**.
3. Press **START**  to reset to default factory settings.



# 32 Oven Controls





## MY FAVORITES



The Favorites settings allows you to save your most frequently used or most complex cooking sequences. This feature will save the cooking mode, the target temperature and the cooktime (if any). The oven can recall up to six cooking sequences from its internal memory, three for each oven, which are easily accessible from a one touch button. These functions can be used with all cooking modes and features.



### To save a Favorite (example is a 450°F Bake for 30 minutes):

- Saving a Favorite can only be done for an oven which is currently in operation.

1. Select oven by pressing either **UPPER OVEN** UPPER OVEN or **LOWER OVEN** LOWER OVEN.
2. Press **BAKE** . The default temperature will appear in the display.
3. Enter temperature needed; **4 5 0**.
4. Press **COOK OPTIONS**  to bring up the cook options items.
5. Press **COOK TIME** . The time numbers will blink in the display.
6. Enter time needed; **3 0**.
7. Press **START** .
8. Press and hold for 3 seconds any **MY FAVORITE**  pad. Notice that the red indicator above the key will light up.

### To recall a Favorite:

- Recalling a Favorite can only be done for an oven which is not currently in operation.

1. Select oven by pressing either **UPPER OVEN** UPPER OVEN or **LOWER OVEN** LOWER OVEN.
2. Press any **MY FAVORITE**  pad which is currently lighted up.
3. Press **START** .

### To overwrite a Favorite:

1. To overwrite a My Favorite simply start a new cooking sequence and save it into the same My Favorite location (1, 2 or 3) for the selected oven as shown in example above. The new My Favorite settings will overwrite the old ones.

### To delete a Favorite:



1. Select oven by pressing either **UPPER OVEN** UPPER OVEN or **LOWER OVEN** LOWER OVEN.
2. Press the currently lighted up **MY FAVORITE**  pad you wish to delete for **3 seconds**.

## SABBATH FEATURE





### (FOR USE ON THE JEWISH SABBATH & HOLIDAYS)

The  $HI_{hi}^{+}$  and  $LO_{lo}^{-}$  pads are used to set the Sabbath feature. The Sabbath feature may only be used with the **BAKE**  pad. The oven temperature may be set higher or lower after setting the Sabbath feature (the oven temperature adjustment feature should be used only during Jewish Holidays), however the display will not visibly show or provide any audible tones indicating whether the change occurred correctly. Once the oven is properly set using Bake with the Sabbath feature active, the oven will remain continuously ON until cancelled. This will override the factory preset 12-Hour Energy Saving feature.

If the oven light will be needed during the Sabbath, press **OVEN LIGHT**  before activating the Sabbath feature. Once the oven light is turned ON and the Sabbath feature is active, the oven light will remain ON until the Sabbath feature is turned OFF. If the oven light needs to be OFF, be sure to turn the oven light OFF before activating the Sabbath feature.

**IMPORTANT NOTES:** It is not advised to attempt to activate any other program feature other than **BAKE** while the Sabbath feature is active. ONLY the following key pads will function after setting the Sabbath feature: **0** to **9**, **BAKE** , **START** , **CANCEL** ,  $HI_{hi}^{+}$  and  $LO_{lo}^{-}$ . **ALL OTHER KEYPADS** will not function once the Sabbath feature is properly activated.

### To Program the Upper Oven to Begin Baking Immediately & Activate the Sabbath feature (example: baking at 350°F)



1. Place the food in the oven.
2. Select oven by pressing either **UPPER OVEN** UPPER OVEN or **LOWER OVEN** LOWER OVEN.
3. Press **BAKE** .
4. If you desire to set the oven control for a **COOK TIME**  do so at this time. If not, skip this step and continue to step 5. Refer to their section for complete instructions. Remember the oven will shut down after using **COOK TIME**  and therefore may only be used once during the Sabbath/Jewish Holidays.
5. Press **START** .
6. The oven will turn ON and begin heating immediately.
7. Press and hold both the  $HI_{hi}^{+}$  and  $LO_{lo}^{-}$  pads for at least 3 seconds. **SAb** will appear in the oven display. Once SAb appears in the display the oven control will no longer beep or display any further changes and the oven is properly set for the Sabbath feature.



# 34 Oven Controls

## SABBATH FEATURE (CONTINUED)



**Note:** You may change the oven temperature once baking has started. Press **UPPER OVEN** **BAKE** , the numeric key pads for the temperature you want (example for 425°F press **4**, **2**, **5**) and then press **START**  **TWICE** (for Jewish Holidays only). Remember that **the oven control will no longer beep or display any further changes** once the oven is set for the Sabbath feature.

8. The oven may be turned OFF at any time by pressing **CANCEL**  pad (this will turn the oven OFF only). To turn OFF the Sabbath feature press and hold both the **HI<sub>hi</sub><sup>+</sup>** and **LO<sub>lo</sub><sup>-</sup>** pads for at least 3 seconds. **SAb** will disappear from the display.

Should you experience a power failure or interruption, the oven will shut off. When power is returned the oven will not turn back on automatically. **SF** (Sabbath Failure) will be displayed in the oven control display. The oven will remember that it is set for the Sabbath and the food may be safely removed from the oven while still in the Sabbath feature, however the oven cannot be turned back on until after the Sabbath. After the Sabbath observance turn OFF the Sabbath feature. Press and hold both the **HI<sub>hi</sub><sup>+</sup>** and **LO<sub>lo</sub><sup>-</sup>** pads for at least 3 seconds. **SAb** will disappear from the display and the oven may be used with all normal functions. For further assistance, guidelines for proper usage, and a complete list of models with the Sabbath feature, please visit the web at <http://www.star-k.org>.

## USING THE SELF-CLEAN FEATURE

### Adhere to the Following Cleaning Precautions:

- Allow the oven to cool before cleaning.
- Wear rubber gloves when cleaning any exterior parts of the oven manually.

During the self-cleaning cycle, the outside of the oven can become very hot to the touch. DO NOT leave small children unattended near the appliance.

Before cleaning any part of the oven, be sure the oven is turned off or else push **CANCEL** (V) pad. Wait until the oven is cool.

**DO NOT** use commercial oven cleaners or oven protective coatings in or around any part of the self-cleaning oven. **DO NOT** clean the oven door gasket. The gasket on the oven door is essential for a good seal. Care should be taken not to rub, damage or move the gasket. **DO NOT** use any cleaning materials on the gasket. Doing so could damage it. **DO NOT** use aluminum foil to line the oven bottom. This may affect cooking or foil could melt and damage the oven surface.

### Preparing the Oven for Self-Cleaning:

1. Remove any excess spillovers in the oven cavity before starting the self-cleaning cycle. To clean, use hot soapy water and a cloth. Large spillovers can cause smoke or a fire when subjected to high temperatures. **DO NOT** allow food spills with a high sugar or acid content (such as tomatoes, sauerkraut, fruit juices or pie filling) to remain on the surface as they may leave a dull spot even after cleaning.
2. Clean any soil from the oven frame and the door liner (see illustration). These areas heat sufficiently during a self-clean to burn soil on. Clean with hot soapy water.
3. Remove the broiler pan and insert, all utensils and any foil. These items can not withstand high cleaning temperatures.
4. Oven racks and oven rack supports must be removed. If they are not removed the self-cleaning cycle can not start and Remove Racks will appear in the display indicating that you must remove the racks and racks supports. When the cycle has finished and the door can be opened replace the oven rack supports and oven racks.

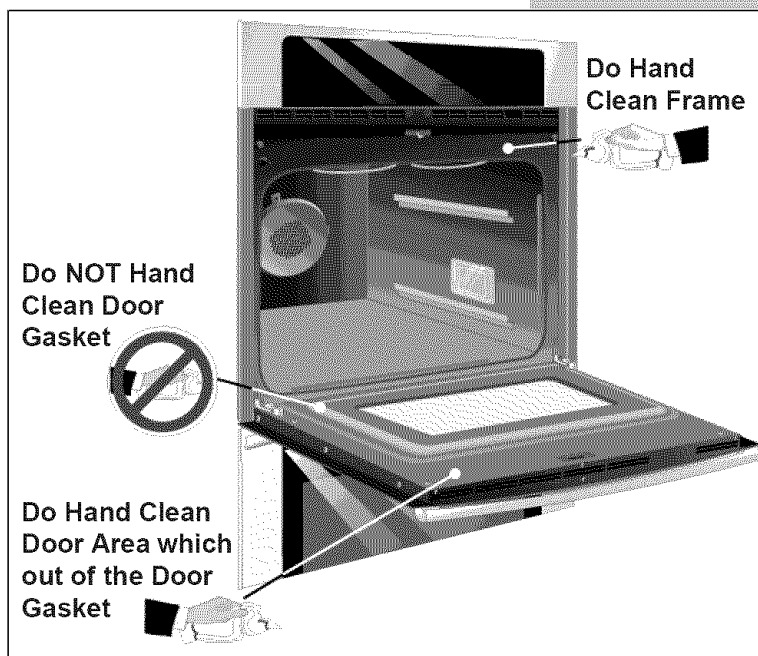

**CAUTION** The health of some birds is extremely sensitive to the fumes given off during the self-clean cycle of any wall oven. Move birds to another well ventilated room.



# 36 Care & Cleaning

## STARTING SELF-CLEAN CYCLE



A self-cleaning oven cleans itself with high temperatures (well above cooking temperatures) which eliminate soil completely or reduce it to a fine powdered ash you can whisk away with damp cloth. If you are planning to use the oven directly after a self-clean cycle remember to allow time for the oven to cool down and the oven door to unlock. This normally takes about one hour.

### To set the controls for a Self-Cleaning cycle:

1. Remove the oven racks and the racks supports.
2. Be sure the clock is set with the correct time of day and the oven door is closed.
3. Select oven by pressing either **UPPER OVEN** UPPER OVEN or **LOWER OVEN** LOWER OVEN.
4. Press **CLEAN**
5. Press **LITE** ● for a 2 hour self-clean, or press **MEDIUM** ●● for 3 hours, or press **HEAVY** ●●● for 4 hours.
6. Press **START**
7. As soon as the control is set, the motor driven oven door lock will begin to close automatically. Once the door has been locked the "DOOR " icon will stop flashing and remain on.

Note: Allow about 15 seconds for the oven door lock to close.

### To set the controls for a delayed Self-Cleaning cycle:

1. Follow the instructions above.
2. Press **COOK OPTIONS**
3. Press **END TIME**
4. Enter time of day needed for the end of the cycle (example for "6:00"; ).
5. Press **START**

### When the Self-Clean Cycle is Completed:

1. The time of day and "DOOR " will remain ON.
2. The display will show an "Hot" message while the oven is still too hot to open door.
3. Once the oven has cooled down for 1 HOUR, and the "DOOR " icon is no longer displayed, the oven door can then be opened.

### Stopping or Interrupting a Self-Cleaning Cycle:

If it becomes necessary to stop or interrupt a self-cleaning cycle due to excessive smoke:

1. Press **CANCEL**
2. Once the oven has cooled down for approximately 1 HOUR and the "DOOR " icon is no longer displayed, the oven door can then be opened.

**⚠ WARNING** During the self-cleaning cycle, the outside of the wall oven can become very hot to the touch. **DO NOT** leave small children unattended near the appliance; they may be burned if they touch the hot oven door surfaces.

**⚠ CAUTION** **DO NOT** force the oven door open. This can damage the automatic door locking system. Use care when opening the oven door after the self-cleaning cycle. Stand to the side of the oven when opening the door to allow hot air or steam to escape. The oven may still be VERY HOT.

## GENERAL CLEANING

### Cleaning Various Parts of Your Appliance

Before cleaning any part of the appliance, be sure all controls are turned OFF and the appliance is COOL. REMOVE SPILLOVERS AND HEAVY SOILING AS SOON AS POSSIBLE. REGULAR CLEANINGS WILL REDUCE THE NUMBER OF MAJOR CLEANINGS LATER

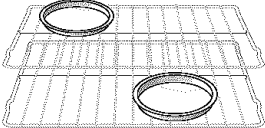
Surfaces	How to Clean
<b>Glass, Painted and Plastic</b> Body Parts and Decorative Trim	<i>For general cleaning</i> , use hot, soapy water and a cloth. <i>For more difficult soils and built-up grease</i> , apply a liquid detergent directly onto the soil. Leave on soil for 30 to 60 minutes. Rinse with a damp cloth and dry. <b>DO NOT</b> use abrasive cleaners on any of these materials; they can scratch.
<b>Control Panel</b>	<i>Before cleaning the control panel</i> , turn all controls to OFF. Lightly spray the control panel with a liquid cleaner. Wipe with a soft cloth or paper towel. <b>DO NOT</b> use abrasive cleaners or scouring pads. These can permanently damage the control panel surface.
<b>Porcelain Enamel</b> Broiler Pan and Grid	Gentle scouring with a soapy scouring pad will remove most spots. Rinse with a 1:1 solution of clear water and ammonia. <i>If necessary</i> , cover difficult spots with an ammonia-soaked paper towel for 30 to 40 minutes. Rinse with clean water and a damp cloth, and then scrub with a soap-filled scouring pad. Rinse and wipe dry with a clean cloth. Remove all cleaners or the porcelain may become damaged during future heating.
<b>Stainless Steel, Chrome</b> Decorative Trim, Oven Racks, Oven Racks Support	Clean with hot, soapy water and a dishcloth. Rinse with clean water and a cloth. Cover stubborn spots with an ammonia-soaked paper towel for 30 to 40 minutes. Rinse. Cleaners made especially for stainless steel are recommended. Be sure to rinse the cleaners as bluish stains may occur during heating and cannot be removed.
<b>Oven Racks</b> 	Oven racks and oven rack supports must be removed from the oven during the self-clean cycle for cleaning. If they are not removed, the self-clean cycle will not start. Clean them as described above.
<b>Oven Door</b>	To clean oven door, wash with hot, soapy water and a clean cloth. <b>DO NOT</b> immerse the door in water or clean the oven door gasket.
<b>Oven Door Gasket</b>	The oven gasket located on the inner frame of the door and visible when the door is opened is essential for a good seal. Care should be taken not to rub, damage or remove the gasket.

# 38 Care & Cleaning

## CARE AND CLEANING OF STAINLESS STEEL

Special care and cleaning are **required** for maintaining the appearance of stainless parts. Please refer to the table provided at the beginning of the **General Care & Cleaning** section in this Use & Care Manual.

## TO REMOVE AND REPLACE OVEN DOOR

1. Open the door to the fully opened position.
2. Pull up the lock located on each hinge support toward front of range. You may have to apply a little upward pressure on the lock to pull it up.
3. Grasp the door by the sides, pull the bottom of the door up and toward you to disengage the hinge supports.  
Keep pulling the bottom of the door toward you while rotating the top of the door toward the appliance to completely disengage the hinge levers.
4. Proceed in reverse to re-install the door. Make sure the hinge supports are fully engaged before unlocking the hinge levers.

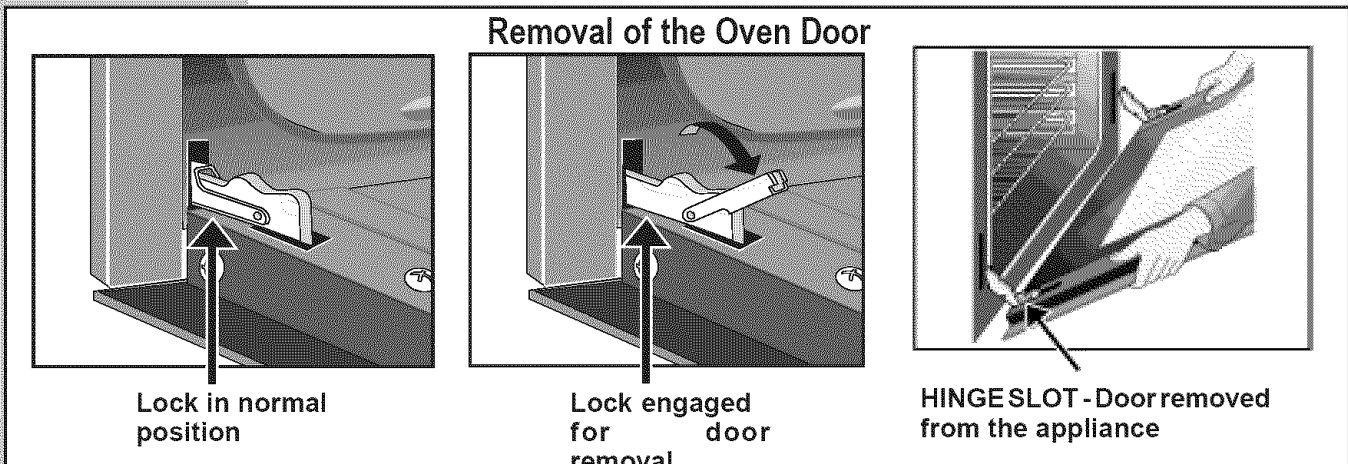

## SPECIAL DOOR CARE INSTRUCTIONS

Most oven doors contain glass that can break.

Read the following recommendations:

1. Do not close the oven door until all the oven racks are fully in place.
2. Do not hit the glass with pots, pans, or any other object.
3. Scratching, hitting, jarring or stressing the glass may weaken its structure causing an increased risk of breakage at a later time.

## OVEN LIGHT

An interior oven light will turn on automatically when the oven door is opened. The oven light may be turned on when the door is closed by using the oven light switch located on the control panel.

The lamp is covered with a glass shield. The glass shield can be removed to be cleaned manually or to change the oven light.

THIS GLASS SHIELD MUST BE IN PLACE WHENEVER THE OVEN IS IN USE.

### To replace the light bulb:

**CAUTION: BE SURE THE OVEN IS COOL.**

1. Turn the power off at the main source.
2. Wear a leather-faced glove for protection against possible broken glass.
3. To remove the glass shield, pull the back side of the shield toward the inside of the oven in a manner to lift it up from the oven side.
4. The glass shield should come out easily by pushing a little toward front of the wall oven.
5. Replace halogen light appliance bulb taking care to not touch the bulb. Touching the halogen bulb with bare fingers can damage it and also burn it.
6. To replace glass shield, proceed in reverse.

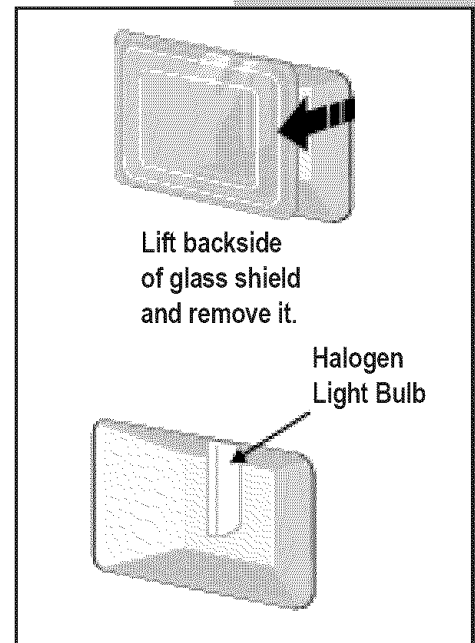

## BROILER PAN CLEANING TIPS

To make cleaning easier, line the bottom of the broiler pan with aluminum foil. DO NOT cover the broiler grid with foil.

To prevent grease from baking on, remove the broiler pan from the oven as soon as cooking is completed. Use hot pads because the broiler pan is extremely hot. Pour off grease. Soak the pan in HOT, soapy water.

Clean the broiler pan as soon as possible after each use. If necessary, use soap-filled steel wool pads. Heavy scouring may scratch the grid.

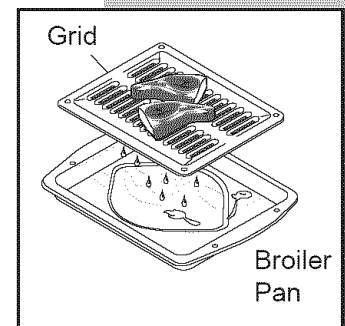

## Baking Problems

For best cooking results pre-heat the oven when baking cookies, breads, cakes, pies or pastries, etc... There is no need to preheat the oven for roasting meats or baking casseroles. The cooking times and temperatures needed to bake a product may vary slightly from your previous appliance.

### Baking Problems and Solutions Chart

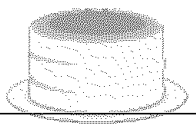
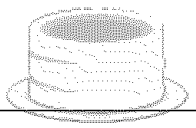
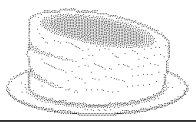
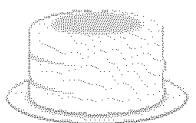
Baking Problems	Causes	Solutions
<p><b>Cookies and biscuits burn on the bottom.</b></p> 	<ul style="list-style-type: none"> <li>• Cookies and biscuits put into the oven before the preheating time is completed.</li> <li>• Oven rack overcrowded or rack position too low.</li> <li>• Dark pan absorbs heat too fast.</li> </ul>	<ul style="list-style-type: none"> <li>• Allow oven to preheat to the selected temperature before placing food in oven.</li> <li>• Choose pan sizes that will permit 5.1 cm to 10.2 cm (2" to 4") of air space on all sides when placed in the oven.</li> <li>• Use a medium-weight aluminum baking sheet.</li> </ul>
<p><b>Cakes too dark on top or bottom.</b></p> 	<ul style="list-style-type: none"> <li>• Cakes put into the oven before preheating time is completed.</li> <li>• Rack position too high or low.</li> <li>• Oven too hot.</li> </ul>	<ul style="list-style-type: none"> <li>• Allow oven to preheat to the selected temperature before placing food in the oven.</li> <li>• Use proper rack position for baking needs.</li> <li>• Set oven temperature 25°F/12°C lower than recommended.</li> </ul>
<p><b>Cakes not done in the center.</b></p> 	<ul style="list-style-type: none"> <li>• Oven too hot.</li> <li>• Incorrect pan size.</li> <li>• Pan not centered in oven.</li> </ul>	<ul style="list-style-type: none"> <li>• Set oven temperature 25°F/12°C lower than recommended.</li> <li>• Use pan size suggested in recipe.</li> <li>• Use proper rack position and place pan so there is 5.1 cm to 10.2 cm (2" to 4") of space on all sides of pan.</li> </ul>
<p><b>Cakes not level.</b></p> 	<ul style="list-style-type: none"> <li>• Range not level.</li> <li>• Pan too close to oven wall or rack overcrowded.</li> <li>• Pan warped.</li> </ul>	<ul style="list-style-type: none"> <li>• Place a marked glass measuring cup filled with water on the center of the oven rack. If the water level is uneven, refer to the installation instructions for leveling the range.</li> <li>• Be sure to allow 5.1 cm to 10.2 cm (2" to 4") of clearance on all sides of each pan in the oven.</li> <li>• Do not use pans that are dented or warped.</li> </ul>
<p><b>Foods not done when cooking time is up.</b></p> 	<ul style="list-style-type: none"> <li>• Oven too cool.</li> <li>• Oven overcrowded.</li> <li>• Oven door opened too frequently.</li> </ul>	<ul style="list-style-type: none"> <li>• Set oven temperature 25°F/12°C higher than suggested and bake for the recommended time.</li> <li>• Be sure to remove all pans from the oven except the ones to be used for baking.</li> <li>• Open oven door only after shortest recommended baking time.</li> </ul>

## IMPORTANT

Before calling for service, review this list. It may save you both time and expense. This list includes common experiences that are not the result of defective workmanship or material in your cooktop.

## OVEN CONTROL BEEPS AND DISPLAYS AN "F" ERROR CODE

- Electronic control has detected a fault condition. Push **CANCEL pad** to clear the display and stop the display from beeping. Reprogram the oven. If a fault reoccurs, record the fault number, push the **CANCEL pad** and contact an authorized servicer.

## INSTALLATION

- Place oven rack in center of oven. Place a level on the oven rack. Contact installing agent if rack and cabinet cutout flooring are not level.
- Kitchen cabinet misalignment may make oven appear to be not level. Be sure cabinets are square and level. Contact cabinet maker to correct problem.

## ENTIRE OVEN DOES NOT OPERATE

- When the oven is first plugged in, or when the power supply to the oven has been interrupted, the display will flash. The oven cannot be programmed until the clock is set.
- Be sure electrical cord is securely connected into the electrical junction box.
- Cord/plug is not installed and/or connected. Cord is not supplied with oven. Contact your dealer, installing agent or authorized servicer.
- Service wiring not complete. Contact your dealer, installing agent or authorized servicer.
- Power outage. Check house lights to be sure. Call your local electric company.
- Short in cord/plug. Replace cord/plug.
- Controls are not set properly. See instructions to set the controls.
- House fuse has blown or circuit breaker has tripped immediately following installation.
- House fuse may not be fully engaged. Check fuse and screw or engage circuit breaker securely.

## OVEN LIGHT DOES NOT WORK

- Burned-out or loose bulb. Follow the instructions under **Oven Light** to replace or tighten the bulb.

# 42 Solutions to Common Problems

---

## SELF-CLEANING CYCLE DOES NOT WORK

- Make sure the oven door is closed.
- Make sure you have removed the oven racks and the oven rack supports from the oven.
- Controls not set properly. Follow instructions under "Using the Self-Clean Feature".

## OVEN SMOKES EXCESSIVELY DURING BROILING

- Meat too close to the broiler element. Reposition the rack to provide more clearance between the meat and the broiler. Preheat broil element for quick searing operation.
- Meat not properly prepared. Remove excess fat from meat. Cut remaining fatty edges to prevent curling, but do not cut into the lean.
- Grid on broiler pan wrong side-up. Grease does not drain into broiler pan. Always place the grid on the broiler pan with the ribs up and the slots down to allow grease to drip into the pan.
- Broiler pan used without grid or grid cover with aluminum foil. **DO NOT** use the broiler pan without the grid or cover the grid with aluminum foil.
- Oven needs to be cleaned. Grease has built up on oven surfaces. Regular cleaning is necessary when broiling frequently. Grease or food spatters cause excessive smoking.

## SOIL NOT COMPLETELY REMOVED AFTER SELF-CLEANING CYCLE IS COMPLETED

- Failure to clean bottom, from top of oven, frame of oven or door area outside oven seal. These areas are not in the self-cleaning area, but get hot enough to burn on residue. Clean these areas before the self-cleaning cycle is started. Burned on residue can be cleaned with a stiff nylon brush and water or a nylon scrubber. Be careful not to damage the oven gasket.
- Excessive spillovers in oven. Set the self-clean cycle for longer cleaning time.

## POOR BAKING RESULTS

- Many factors affect baking results. See **Baking** for hints, causes and corrections. See **Adjusting Oven Temperature**.

## FLAMES INSIDE OVEN OR SMOKE FROM VENT

- Excessive spillovers in oven. This is normal, especially for high oven temperatures, pie spillovers or for large amounts of grease on bottom of oven. Wipe up excessive



# 44 Warranty Information

Your appliance is covered by a one year limited warranty. For one year from your original date of purchase, Electrolux will repair or replace any parts of this appliance that prove to be defective in materials or workmanship when such appliance is installed, used, and maintained in accordance with the provided instructions. In addition, the glass cooktop or radiant surface element of your appliance (excluding built-in and free-standing range appliances) is covered by a two through five year limited warranty. During the 2nd through 5th years from your original date of purchase, Electrolux will provide a replacement glass cooktop or radiant surface element for your appliance which has proven to be defective in materials or workmanship when such appliance is installed, used, and maintained in accordance with the provided instructions.

## Exclusions

This warranty does not cover the following:

1. Products with original serial numbers that have been removed, altered or cannot be readily determined.
2. Product that has been transferred from its original owner to another party or removed outside the USA or Canada.
3. Rust on the interior or exterior of the unit.
4. Products purchased "as-is" are not covered by this warranty.
5. Food loss due to any refrigerator or freezer failures.
6. Products used in a commercial setting.
7. Service calls which do not involve malfunction or defects in materials or workmanship, or for appliances not in ordinary household use or used other than in accordance with the provided instructions.
8. Service calls to correct the installation of your appliance or to instruct you how to use your appliance.
9. Expenses for making the appliance accessible for servicing, such as removal of trim, cupboards, shelves, etc., which are not a part of the appliance when it is shipped from the factory.
10. Service calls to repair or replace appliance light bulbs, air filters, water filters, other consumables, or knobs, handles, or other cosmetic parts.
11. Labor or in-home service costs during the additional limited warranty periods beyond the first year from your original date of purchase.
12. Pickup and delivery costs; your appliance is designed to be repaired in the home.
13. Surcharges including, but not limited to, any after hour, weekend, or holiday service calls, tolls, ferry trip charges, or mileage expense for service calls to remote areas, including the state of Alaska.
14. Damages to the finish of appliance or home incurred during transportation or installation, including but not limited to floors, cabinets, walls, etc.
15. Damages caused by: services performed by unauthorized service companies; use of parts other than genuine Electrolux parts or parts obtained from persons other than authorized service companies; or external causes such as abuse, misuse, inadequate power supply, accidents, fires, or acts of God.

## DISCLAIMER OF IMPLIED WARRANTIES; LIMITATION OF REMEDIES

CUSTOMER'S SOLE AND EXCLUSIVE REMEDY UNDER THIS LIMITED WARRANTY SHALL BE REPAIR OR REPLACEMENT AS PROVIDED HEREIN. **CLAIMS BASED ON IMPLIED WARRANTIES, INCLUDING WARRANTIES OF MERCHANTABILITY OR FITNESS FOR A PARTICULAR PURPOSE, ARE LIMITED TO ONE YEAR OR THE SHORTEST PERIOD ALLOWED BY LAW, BUT NOT LESS THAN ONE YEAR.** ELECTROLUX SHALL NOT BE LIABLE FOR CONSEQUENTIAL OR INCIDENTAL DAMAGES SUCH AS PROPERTY DAMAGE AND INCIDENTAL EXPENSES RESULTING FROM ANY BREACH OF THIS WRITTEN LIMITED WARRANTY OR ANY IMPLIED WARRANTY. SOME STATES AND PROVINCES DO NOT ALLOW THE EXCLUSION OR LIMITATION OF INCIDENTAL OR CONSEQUENTIAL DAMAGES, OR LIMITATIONS ON THE DURATION OF IMPLIED WARRANTIES, SO THESE LIMITATIONS OR EXCLUSIONS MAY NOT APPLY TO YOU. THIS WRITTEN WARRANTY GIVES YOU SPECIFIC LEGAL RIGHTS. YOU MAY ALSO HAVE OTHER RIGHTS THAT VARY FROM STATE TO STATE.

## If You Need Service

Keep your receipt, delivery slip, or some other appropriate payment record to establish the warranty period should service be required. If service is performed, it is in your best interest to obtain and keep all receipts. Service under this warranty must be obtained by contacting Electrolux at the addresses or phone numbers below.

This warranty only applies in the USA, Puerto Rico and Canada. In the USA and Puerto Rico, your appliance is warranted by Electrolux Major Appliances North America, a division of Electrolux Home Products, Inc. In Canada, your appliance is warranted by Electrolux Canada Corp. Electrolux authorizes no person to change or add to any obligations under this warranty. Obligations for service and parts under this warranty must be performed by Electrolux or an authorized service company. Product features or specifications as described or illustrated are subject to change without notice.

### USA

1-877-435-3287

Electrolux Major Appliances North America  
P.O. Box 212378  
Augusta, GA 30907

### Canada

1-800-265-8352

Electrolux Canada Corp.  
5855 Terry Fox Way  
Mississauga, Ontario, Canada L5V 3E4