



V-ZUG-Home

Install the app, network your appliances and benefit from a wide range of useful functions.



Operating instructions

CombiSteamer V6000

Steam cooker with fixed water connection

Thank you for choosing to buy one of our products. Your appliance is made to high standards and is easy to use. Nevertheless, please take the time to read these operating instructions in order to familiarize yourself with the appliance and get the best use out of it.

Please follow the safety precautions.

Modifications

Text, diagrams and data correspond to the technical standard of the appliance at the time these operating instructions went to press. The right to make technical modifications for the purpose of the further development of the appliances is reserved.

Validity

These operating instructions apply to:

Model designation	Type	Size system
CombiSteamer V6000 45F	CS6T-23033, CS6T-23045	60-450

Variations depending on the model are noted in the text.



Download updates to your appliance via V-ZUG-Home so that you are always up to date. The latest operating instructions with the new functions incorporated can be found here: vzug.com.



Contents

1	Safety precautions	5	4.23	End of operation.....	29
1.1	Symbols used.....	5	4.24	End of operation when AutoDoor is on (depending on model)	30
1.2	General safety precautions	5	4.25	Subsequent steps.....	30
1.3	Appliance-specific safety precautions	5	4.26	Switching the appliance off.....	31
1.4	Instructions for use	6	4.27	Appliance tips.....	31
2	Using for the first time	9	5	Applications	32
3	Appliance description	10	5.1	Hot air.....	32
3.1	Construction.....	10	5.2	Hot air humid	32
3.2	Operating and display elements	10	5.3	Hot air with steaming	32
3.3	Cooking space	12	5.4	Hot air eco.....	33
3.4	Accessories.....	12	5.5	Steam	33
3.5	AutoDoor (depending on model).....	14	5.6	Regeneration	34
4	Operation	15	5.7	Desiccating (depending on model).....	34
4.1	Operating the display	15	5.8	Vacuisine	34
4.2	Filling the water tank	17	5.9	Professional baking.....	36
4.3	Selecting and starting an application.....	17	5.10	Soft roasting.....	37
4.4	Changing an application.....	18	5.11	Keep warm	39
4.5	Operating time.....	19	5.12	Warming plates in the cooking space	39
4.6	Delayed start / end.....	20	5.13	Wellness	40
4.7	Food probe temperature	20	5.14	Hygiene	40
4.8	Options.....	21	5.15	BakeOmatic	41
4.9	Checking and changing the settings	22	5.16	RegenerateOmatic.....	41
4.10	Preheating	22	5.17	Recipe book.....	42
4.11	Setting to start later	23	5.18	Own recipes.....	43
4.12	Automatic door opening (depending on model)	23	5.19	EasyCook	45
4.13	Application tips.....	24	6	V-ZUG-Home	47
4.14	Favourites.....	24	6.1	Conditions	47
4.15	Pinning	25	6.2	Initial set-up	47
4.16	Timer.....	26	7	User settings	48
4.17	Illumination	27	7.1	Adjusting user settings	48
4.18	Steam reduction.....	27	7.2	Language.....	48
4.19	Display lock.....	27	7.3	Childproof lock	48
4.20	Quiet mode	28	7.4	Display	48
4.21	Time.....	28	7.5	Signals and tones	48
4.22	Cancelling / ending before time	28	7.6	Individual settings	49

7.7	Assistance functions.....	50	13	Disposal	67
7.8	Date and time	50	14	Index	70
7.9	V-ZUG-Home	51	16	Service & Support	75
7.10	Appliance information	51			
7.11	Factory settings	51			
7.12	EcoManagement.....	52			
7.13	Customer Services.....	52			
8	Care and maintenance	52			
8.1	Cleaning the exterior	52			
8.2	Cleaning the cooking space	52			
8.3	Intensive cleaning	53			
8.4	Steam cleaning.....	54			
8.5	Cleaning the appliance door	55			
8.6	Cleaning the door seal.....	57			
8.7	Replacing the door seal	57			
8.8	Replacing the LED light bulb.....	57			
8.9	Cleaning the accessories and shelf guides..	57			
8.10	Descaling.....	58			
9	Trouble-shooting	60			
9.1	Error messages.....	60			
9.2	Other possible problems	61			
9.3	After a power failure	63			
10	Accessories and spare parts	63			
10.1	Accessories.....	63			
10.2	Special accessories.....	64			
10.3	Spare parts.....	64			
11	Technical data	64			
11.1	Light sources	64			
11.2	Note for testing institutes.....	64			
11.3	Temperature measurement.....	65			
11.4	Product fiche.....	65			
11.5	Product information	65			
11.6	EcoStandby	65			
12	Tips and tricks	66			
12.1	Unsatisfactory cooking result... ..	66			
12.2	General tips.....	67			
12.3	Saving energy.....	67			

1 Safety precautions

1.1 Symbols used



Denotes important safety precautions.

Failure to observe said precautions can result in injury or damage to the appliance or equipment!



Information and notes to be observed.



Information on disposal



Information about the operating instructions

- ▶ Indicates step-by-step instructions.
 - Describes how the appliance reacts to the steps taken.
- Indicates a list.

1.2 General safety precautions



- Read the operating instructions before using the appliance for the first time.



- This appliance can be used by children aged 8 and above and by persons with reduced physical, sensory or mental capabilities, or lack of experience and/or knowledge, provided they are supervised or have been instructed on the safe use of the appliance and have understood the hazards involved. Children shall not play with the appliance.

Cleaning and user maintenance shall not be undertaken by children without supervision.

- If an appliance is not equipped with a mains cable and a plug or other means for disconnecting from the mains with a contact opening on each pole complying with the conditions of overvoltage category III for full isolation, an isolating device must be incorporated into the permanently installed electrical installation in accordance with the installation regulations.
- If the mains cable of this appliance is damaged, it must be replaced by the manufacturer or its Customer Services or a similarly qualified person in order to avoid hazard.

1.3 Appliance-specific safety precautions



- **READ THE IMPORTANT SAFETY PRECAUTIONS CAREFULLY AND RETAIN FOR FUTURE USE.**
- **WARNING:** The appliance and its accessible parts get hot during use. Be careful not

to touch the heating elements. Children under 8 years of age must be kept away from the appliance unless they are constantly supervised.

- **WARNING:** Accessible parts can get hot during use. Keep young children away from the appliance.
- If you own an appliance without a door handle, the appliance door can be opened and closed by pressing the «Open/Close» button.
- When the appliance door is opened automatically, small children or animals must not be within the opening range of the appliance door.
- This appliance is intended for use in the home and similar settings such as: in staff kitchens in shops, offices and other commercial establishments; in agricultural establishments; by guests in hotels, motels and other accommodation establishments; in bed and breakfast establishments.
- This appliance is not intended for use in vehicles or on board ships or aircraft or in rooms where there are special conditions such as, for instance, a corrosive or explos-

ive atmosphere (dust, steam or gas) or condensing moisture.

- Do not use aggressive or abrasive cleaning agents or sharp metal scrapers for cleaning the glass in the oven door as they could scratch the surface. This can destroy the glass.
- Only use the food probe recommended for this oven.
- Under no circumstances use a steam cleaner to clean the appliance.
- To avoid overheating, the appliance must not be installed behind a decor door.
- **WARNING:** Never heat food or liquids in sealed containers such as cans or bottles as they are liable to explode due to overpressure.
- See the «Accessories» section for the proper use of insertable parts.

1.4 Instructions for use

Before using for the first time

- The appliance must be installed and connected to the electricity supply in accordance with the separate installation instructions. Have a qualified fitter/electrician carry out the necessary work.

Correct use

- The appliance is designed for use in the home for preparing food. Under no circumstances flambé or cook food using a lot of fat in the cooking space! No liability is assumed for any damage caused by improper use or incorrect handling.
- Never use the appliance to dry animals, textiles, paper, etc.!
- Do not use the appliance as a room heater.
- The appliance should only be installed and operated at an ambient temperature of 5 °C to 35 °C. If frost develops, residual water left in the pumps could freeze and cause damage.
- Any repairs, modifications or manipulations to the appliance, especially any electrically live parts, may only be carried out by the manufacturer, its Customer Services or a similarly qualified person. Repairs if carried out incorrectly may cause serious injury, damage to the appliance and fittings, as well as affect the functioning of the appliance. If the appliance is not working properly or in case a repair is needed, follow the instructions given in the «Service & Support» section. If required, please contact our Customer Services.
- Use original spare parts only.
- Retain these operating instructions for future reference.
- The appliance corresponds to recognized technology standards and the relevant safety regulations. Proper use of the appliance is essential to avoid damage and accidents. Please therefore follow the precautions given in these operating instructions.
- Do not attach magnets to the display.

Note on use

- Use the childproof locking facility.
- If the appliance is visibly damaged, do not use it. Contact our Customer Services.

- If the appliance is not functioning properly, disconnect it from the power supply immediately.
- Ensure there are no foreign bodies or pets in the cooking space before closing the appliance door.
- Objects that could pose a danger if the appliance were accidentally switched on should not be stored in the cooking space. Do not store food or any temperature-sensitive or inflammable materials, e.g. cleaning agents, oven sprays, etc., in the cooking space.

Caution: Risk of burns!

- The appliance gets very hot when in use. The appliance door also gets hot.
- Steam and/or hot air may escape from the cooking space when the appliance door is opened.
- The heated appliance will remain hot for some time after it is switched off and will cool down only slowly to room temperature. Allow sufficient time for the appliance to cool down before, for instance, cleaning it.
- Overheated fat and oil can easily catch fire. Heating oil in the cooking space to sear meat is dangerous and should not be done. Never attempt to extinguish burning oil or fat with water. Danger of explosion! Smother the flames with a fire blanket. Keep doors and windows closed.
- Do not pour spirits (brandy, whisky, schnapps, etc.) over hot food. Danger of explosion!
- Do not leave the appliance unattended when drying herbs, bread, mushrooms, etc. If the foodstuff dries out too much, it can pose a fire hazard.
- If you notice smoke possibly coming from a fire in the appliance or inside the cooking space, keep the appliance door closed and disconnect the appliance from the mains power supply.
- Accessories get hot in the cooking space. Use protective gloves or oven cloths.

Caution: Risk of injury!

- Be careful not to put fingers in the door hinges, as there is otherwise a risk of injury if the appliance door is moved. Particular care should be taken when children are around.
- Only leave the appliance door open in the airing position. An open appliance door poses a danger of tripping or injury! Do not sit or rest on the appliance door or use it as a storage surface.
- For cookers: A hob guard can be fitted to protect small children. Hob guards are available from specialist retailers.

Caution: Risk to life!

- Danger of suffocation! Keep packaging material, e.g. plastic film and polystyrene, away from children. Packaging material can be dangerous for children.

How to avoid damaging the appliance

- Close the appliance door carefully.
- Do not place any protective insert or aluminium foil on the floor of the cooking space with appliances with no visible bottom heating element.
- Do not use objects that can rust in the cooking space.
- Using knives or cutting wheels on the baking tray will visibly damage the surface.
- To prevent corrosion, leave the appliance door open in the airing position until the cooking space has cooled down.
- When cleaning the appliance make sure no water gets inside it. Use a moderately damp cloth. Do not spray the outside or the inside of the appliance with water. If water gets inside the appliance, it will cause damage. See the «Care and maintenance» section.

2 Using for the first time

Before operating the newly installed appliance for the first time, the following steps should be taken:

- ▶ Remove packaging and transport materials as well as any protective blue film from out of the cooking space.
- ▶ Remove all the accessories from out of the cooking space.
- ▶ Clean the cooking space.
- ▶ Long touch the display.
 - The appliance starts.
 - Various user settings necessary for operation appear in the display one after the other.
- ▶ Make the settings and confirm.
- ▶ Fill the water tank up to the «max.» mark with fresh, cold drinking water and slot into position in the water tank compartment.
- ▶ Start the rinsing of the water system.

If the rinsing is skipped, it must be carried out manually.

- ▶ Heat the empty cooking space to 100 °C for 5 minutes using the  «Steam» application.
 - Wait 20 minutes until the appliance cools down and the water is pumped back.
- ▶ Wipe down and dry the cooking space.
- ▶ Start the initial burn-in.

If the initial burn-in step is skipped, it must be carried out manually after completing the initial set-up.

- ▶ Heat the empty cooking space (without wire shelves, baking trays, etc.) to 200 °C for about 30 minutes using the  «Hot air» application.



Burning-in removes any oily residues in the cooking space. As there is likely to be some smoke and odour given off, animals (especially birds) should not be in the same room during the burn-in process. Ventilate the room well both during and after the process.

- ▶ Clean the filter in the water outlet.



If the outlet is blocked in spite of this, contact Customer Services.



All temperatures in these operating instructions are given in degrees Celsius (°C).

3 Appliance description

3.1 Construction

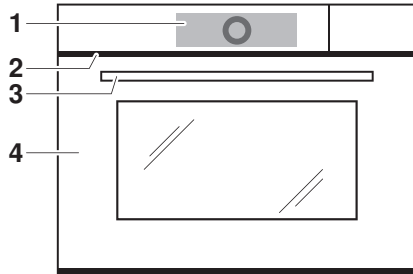

- 1 Operating and display elements
- 2 Ventilation opening
- 3 Door handle (depending on model)
- 4 Appliance door

3.2 Operating and display elements

App view

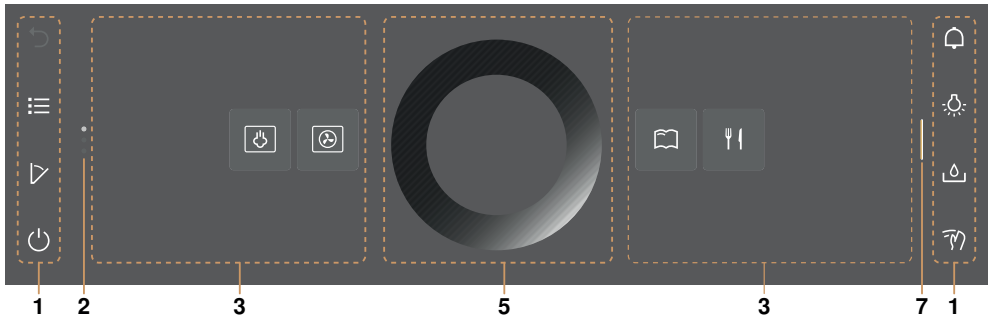







List view









- 1 Function bars with function buttons
- 2 Scroll bar/position
- 3 Apps
- 4 List of applications
- 5 CircleSlider
- 6 Information
- 7 Bar for expanding the function bar

Left function buttons

	Step back
	Start screen
	List view
	App view
	AutoDoor (depending on model)
	Switch off

Right function buttons

	Timer
	Cooking space illumination
	Open water compartment flap
	Display lock
	Quiet mode
	Clock

Ready to start

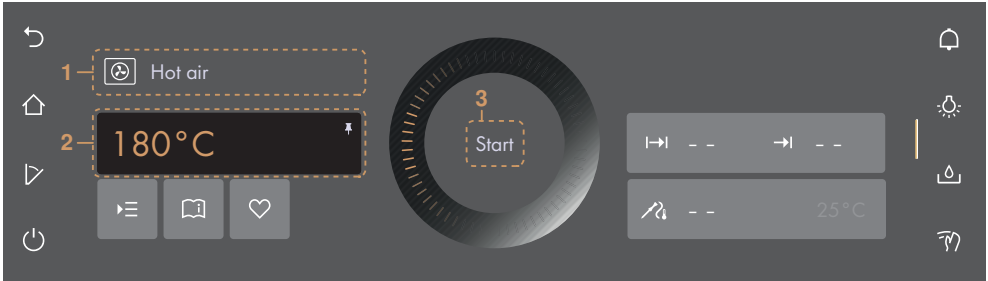







1 Application

2 Main value

3 Start operation

Setting options

-  Options
-  Application tips
-  Favourite

-  Operating time
-  End
-  Core temperature

Symbol

 V-ZUG-Home

3.3 Cooking space

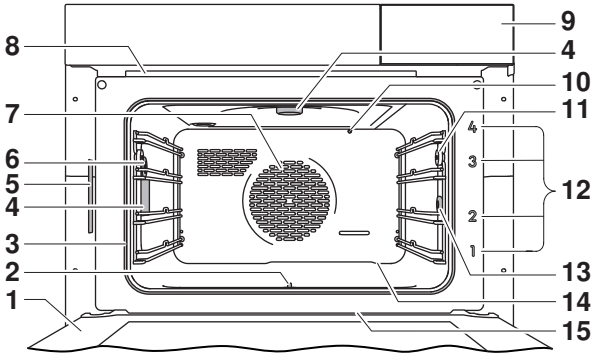

- | | |
|------------------------------|-----------------------------------|
| 1 Appliance door | 9 Water tank compartment |
| 2 Water outlet with filter | 10 Temperature sensor |
| 3 Door seal | 11 Knurled nut |
| 4 Cooking space illumination | 12 Levels |
| 5 Identification plate | 13 Socket for food probe |
| 6 Climate sensor | 14 Water inlet |
| 7 Hot air fan | 15 Door-mounted condensate trough |
| 8 Cooking space ventilation | |

3.4 Accessories







Incorrect handling can cause damage!
Do not use knives or cutting wheels on the accessories.



Do not store the accessories in the cooking space. Remove all non-ovenproof accessories before use.

Baking tray



- Baking tin e.g. for flans, bread and biscuits
- Use together with the wire shelf as a drip tray.
- If not fully covered by the baking, its shape can become distorted during baking. This is normal. As it cools down, it will go back to its original form.
- Not suitable for use with the  «Steam» and  «Vacu-isine» applications.
- ▶ Instead use the stainless steel tray.
- Suitable for use with the  «Regeneration» and  «Hot air with steaming» applications if the temperature is set higher than 150 °C. With frequent use, the appearance of the surface can change. However, this does not affect the functionality.

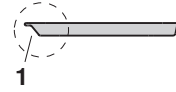

- ▶ Ensure that the «sloped» side **1** of the baking tray is to the back of the cooking space.

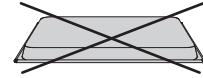

- ▶ Only use the normal way round – not upside down.



Stainless steel tray

- Use together with the wire shelf or perforated cooking tray as a drip tray.
- Baking tin for baking e.g. aperitif nibbles and biscuits on two levels using the  «Hot air» application.
- If not fully covered by the baking, its shape can become distorted during baking. This is normal. As it cools down, it will go back to its original form.
- Suitable for use with the  «Regeneration» and  «Hot air with steaming» applications if the temperature is set lower than 150 °C. High temperatures can cause discoloration.

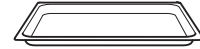

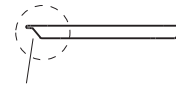

- ▶ Ensure that the «sloped» side **1** of the stainless steel tray is to the back of the cooking space.

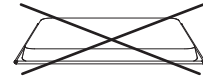

- ▶ Only use the normal way round – not upside down.



Perforated cooking tray

- Particularly suitable for  «Steam» and  «Vacuisine».
- For cooking fresh or frozen vegetables, meat and fish
- For standing ramekins, preserving or bottling jars, etc. on.
- For extracting juice from berries, fruit, etc.



- ▶ Ensure that the «sloped» side **1** of the cooking tray is to the back of the cooking space.

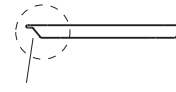

- ▶ Only use the normal way round – not upside down.

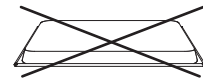

Wire shelf



If you are using your steamer in combination with an oven: Do not use the wire shelf from the oven in the steamer! Risk of rusting!

The wire shelf from the steamer is distinguished through a metal plate with a steam symbol.

3 Appliance description

- For standing roasting and baking tins on
- For standing meat, frozen pizza, etc. on
- ▶ Ensure that the bar **1** is to the back of the cooking space. This enables the food to be removed safely from the cooking space.
- Serves as a cooling rack.

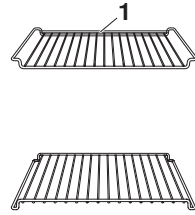

3-point food probe



The food probe cannot be used for cooking space temperatures of over 230 °C. There must be a distance between the food probe and the roof of the cooking space of at least 5 cm.

The food probe has three measuring points for particularly precise temperature measurement. These also help to record the food probe temperature correctly even if the food probe has not been inserted correctly. The measuring points are at points 1, 2 and 4 on the scale of the food probe.

- For measuring the core temperature of food

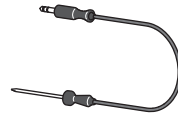

For recommended food probe temperatures, see «EasyCook».

Water tank with lid



Do not use filtered (demineralized) or distilled water. Pour away any water that is left in the water tank and fill with fresh drinking water.

- ▶ Only fill with fresh, cold drinking water up to the «max.» mark.
 - The «max.» mark is in the round opening in the lid. Let into it is a tab embossed with «max.».

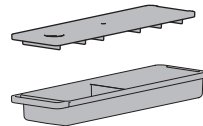

Special accessories



Place any accessories not included in the scope of delivery on the wire shelf.

- ▶ Special accessories can be found at: www.vzug.com

3.5 AutoDoor (depending on model)



- Children aged 3 years and under must be kept away from the appliance.
- Children between 3 and 8 years of age must be kept away from the appliance unless they are continuously supervised.
- This appliance can be used by children aged from 8 years and above if they have been given instruction or are supervised.
- Children shall not play with the appliance.
- Children shall not carry out cleaning and user maintenance of the appliance without supervision.
- The responsibility thus lies with the supervisor.

- ▶ For handleless appliances, the appliance door is opened and closed by touching the ▽ function button.



The appliance door can be opened and closed at any time.

- ▶ The ▽ function button together with the controller and the drive serve the function of a handle.
- ▶ If the resistance is too great, the appliance door is uncoupled from the drive mechanism and can then be moved freely.
- ▶ Remove the obstruction from the appliance door and trigger «AutoDoor» again using the ▽ function button.
 - If this fails repeatedly, contact Customer Services.



A warning tone indicates automatic movement of the appliance door. The warning tone is emitted before and during automatic movement of the appliance door.

- The tones can be set in the user settings (see page 48).



The appliance door can be placed in the airing position by long pressing the button.

- ▶ Press and hold the AutoDoor function button.
 - The following message appears in the display:



- ▶ Choose the desired option.

When to use AutoDoor

- Opening and closing the appliance door as well as placing it in the airing position by pressing the ▽ function button
- Automatic door opening and closing (see page 21)
- The desiccating application (see page 34)

4 Operation

4.1 Operating the display

Switching the appliance on

The appliance is operated using the display.

The clock is only visible in EcoStandby if enabled in the user settings.

- ▶ Long touch the display.
 - The start screen appears.

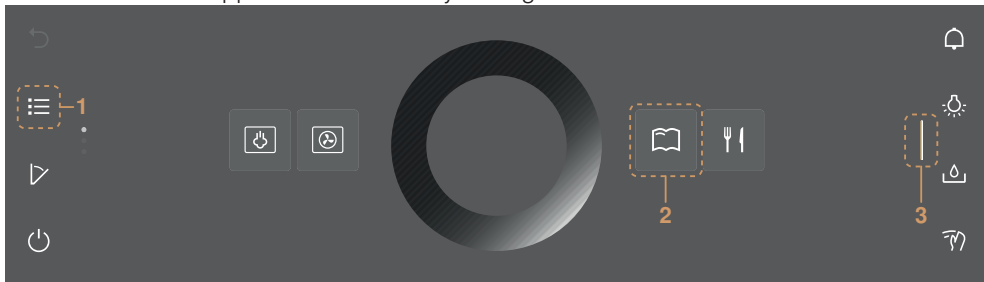

Changing the start screen view

The start screen can be displayed in one of two ways: as an app view (see page 10) or as a list view. The app view is the factory setting.



- ▶ To temporarily change the view, touch the **1** function button.
 - The view is retained only until the display goes dark.
 - The change is then discarded.
 - When the display is called up again, the view set in the user settings appears.
- ▶ To permanently change the view, go in the user settings to «Individual settings» and select the desired start screen view (see page 49).

Displaying quick information

The app view displays the names of the apps as well as the two favourite functions  «Rename» and  «Remove».

- ▶ Press and hold the desired app **2**.
 - Quick information and the favourites function in Favourites appear above the app (see page 24).
- ▶ Release app **2**.
 - Quick information disappears. In the Favourites  application, Quick information does not disappear in order that Rename or Remove can be selected.

Moving an app

The apps can be moved and reordered in the app view.

- ▶ Press and hold the desired app **2** and move it to change the app order.
 - The apps are spread over several pages; only one app can be moved at a time.
- ▶ Release app **2**.
 - The new app order is saved.

Expanding the right function bar

The right function bar can be expanded at any time.

- ▶ Drag the bar **3** to the left.
 - The function bar expands.
 - More functions appear in the display.

Using the CircleSlider

- ▶ Touch the desired application or function.
 - The colour of the selected range turns amber and can now be changed.
 - The temperature range is already activated and can be changed directly.
- ▶ Place your finger on the CircleSlider **4** and move it in a circle.
 - The value range changes.
- ▶ Release the CircleSlider **4**.
- ▶ Press «Start» to start an application or a function.



4.2 Filling the water tank



The water tank is only used for descaling (see page 58).

- ▶ Touch the  «Water compartment flap» function button.
 - The flap of the water tank compartment opens.
- ▶ Take the water tank out of the appliance.
- ▶ Fill the water tank with water.
- ▶ Slot the filled water tank into position in the water tank compartment.
- ▶ Close the water compartment flap manually.

4.3 Selecting and starting an application

- ▶ Long touch the display.
 - The start screen appears.

Selecting an application group

Either:

- ▶ In the  app view, touch the desired application group.
 - The submenu with the associated applications appears in the display.

Or:

- ▶ In the  list view, select the desired application group using the CircleSlider or by swiping up or down.
- ▶ Press «OK» or touch the application.
 - The submenu with the associated applications appears in the display.

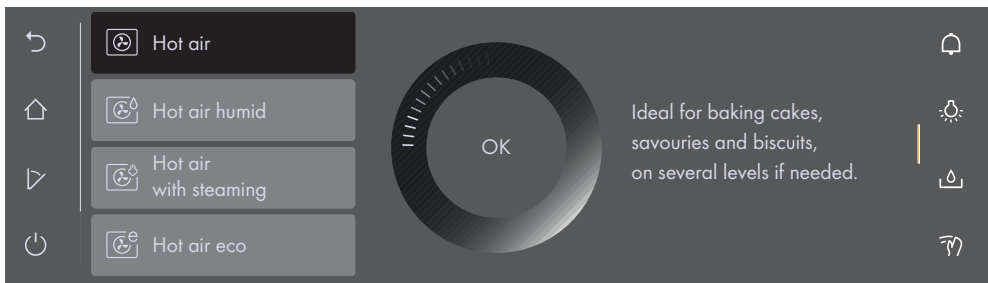

Selecting an application

- ▶ Select the desired application using the CircleSlider.
 - Choose an item in the list by swiping, navigating and touching it.

- ▶ Touch the desired application and press «OK» or touch the application again.
 - The ready to start screen or another submenu with more applications appears in the display.
- ▶ If required, repeat the procedure and select the desired application until the ready to start screen appears in the display:

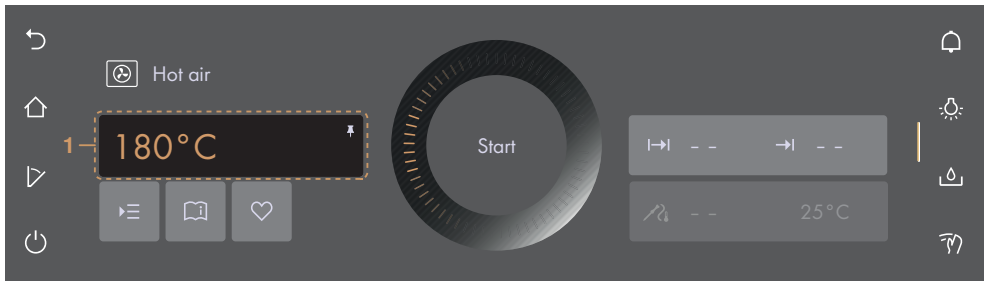

Adjusting values

- ▶ If necessary, adjust the main value **1** using the CircleSlider (see page 22).
- ▶ If necessary, touch  and define, adjust or activate the values of other options (see page 21).

Saving values

- ▶ Permanently save and pin the adjusted main value **1** for the selected application, if required (see page 25).
- ▶ Touch  and create a favourite, if required (see page 24).

Starting an application

- ▶ Press «Start» to start the application.
 - The pulsing circle **2** of the CircleSlider indicates that operation has started.
 - The actual cooking space temperature is displayed as the cooking space is heating up (depending on the application and settings).
 - The progress bar **3** in the CircleSlider shows the countdown to the time remaining or the preheating status of the set application, if set.



If the «Preheat» option is enabled, the actual cooking space temperature is not displayed as the cooking space is heating up. The progress bar indicates the heating status instead.

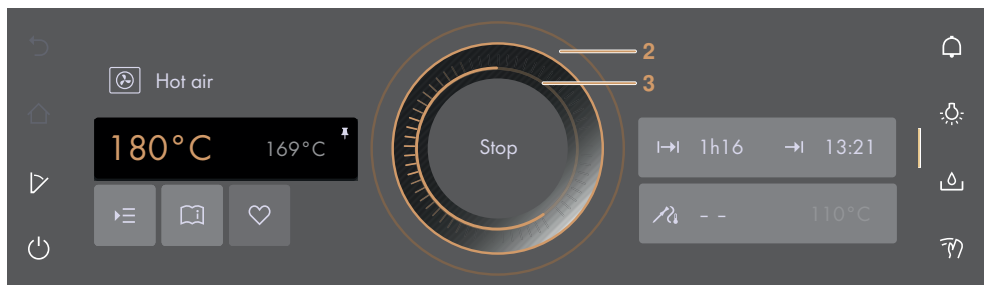

4.4 Changing an application

If an application has not started yet:

- ▶ Touch the  «Start screen» function button.

- The start screen appears (see page 17).
- A new application can be selected.

If an application is already running:

- ▶ Press and hold «Stop».
 - The application is cancelled (see page 28).

4.5 Operating time

The operating time can be set, adjusted or cancelled before or during operation. The application ends automatically when the set duration is up.

Setting the operating time

- ▶ Select the desired application (see page 17).
- ▶ In the value range, touch  «Operating time (see page 21)».
 - The colour of the value range changes to amber.
- ▶ Set the desired operating time using the CircleSlider.

- The desired duration and the calculated end time  appear in the display:

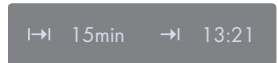

- If preheating is selected or preset, the end time is the approximate preheating time plus the set duration. The operating time set only starts to run when preheating has finished.
- ▶ Press «Start» to start the application.
 - The application starts and the time remaining is displayed.
 - The application ends automatically when the set duration is up (see page 29).
 - If subsequent steps are available for an application, these can be selected when the set duration is up.



If both «Operating time» and «Preheat» are set, the operating time set does not start until preheating has Preheating (see page 22).

Setting range

Application/function	Minimum	Maximum
Applications with steam	10 s	10 h
Applications with hot air	10 s	24 h
Vacuisine	10 s	72 h
Keep warm	5 min	1 h 30 min
Wellness	5–15 min	15 min–1 h
Warming plates in the cooking space	30 min	10 h
Soft roasting	1 h 30 min–3 h 30 min	4 h 30 min



The operating time cannot be changed for applications with a fixed duration.

Showing the clock during operation

The clock and operating time can be shown during operation.

- ▶ Expand the function bar.
- ▶ Touch the  «Clock» function button.
 - The clock and operating time are shown in the display.

Hiding the clock during operation

- ▶ Either touch **X** or press «OK».
 - The clock and operating time are hidden in the display.

4.6 Delayed start / end

The delayed start is activated when for the application selected both the operating time and end are set. The appliance switches automatically on and off again at the desired times.

Setting a delayed start

- ▶ Select the desired application (see page 17).
- ▶ Set the operating time (see page 19).
- ▶ Set further options, if required (see page 21).
- ▶ Put the food in the cooking space if the «Preheat» option has not been turned on.

 **If the 🔥 «Preheat» option has been turned on, do not put the food into the cooking space until the acoustic signal is emitted and the corresponding message appears.**

Before setting the delayed start,

- ▶ in the value range, touch → «End».
 - The colour of the value range changes to amber.
- ▶ Set the desired end time using the CircleSlider.

- The desired duration and the set end time appear in the display:



→ 15min → 13:21

- ▶ Press «Start» to start the delayed start.
 - The time set or remaining to the start of operation and the end of operation appear in the display:

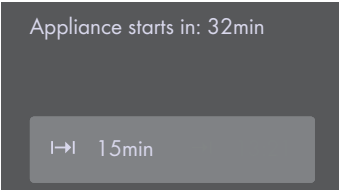

Appliance starts in: 32min

→ 15min

- ▶ If necessary, check and change the settings (see page 22).
 - Any changes to the «Operating time», «End», «Preheat» or «Core temperature» options cause the time remaining to the start of operation to be recalculated.

 If «Operating time» has been set, the end time cannot be set or adjusted during operation.

Example

- ▶ Select the ☺ «Hot air» application and 180 °C.
- ▶ At 8:00, set an operating time of 1 hour and 15 minutes.
- ▶ Set the end time to 11:30.
 - The appliance switches on automatically at 10:15 and off again at 11:30.

4.7 Food probe temperature

 **Only use the food probe supplied.
Do not clean the food probe in the dishwasher. Always keep the plug clean.**

The food probe is used to measure the temperature inside the food (referred to as the food probe temperature). As soon as the food reaches the desired target temperature (the food probe temperature that should be attained at the end of the cooking process), operation stops automatically. It is also possible to simply measure the food probe temperature without stopping operation.



For a correct food probe temperature reading, the food probe must as far as possible be fully inserted into the centre of the food.

The optimal target temperature depends on the cut of meat and on the degree of doneness.

Refer to the information on target temperatures in «EasyCook».

Setting

- ▶ Plug in the food probe.
- ▶ Select the desired application (see page 17).
- ▶ Set the desired temperature using the CircleSlider.
- ▶ In the value range, touch  «Food probe temperature».
 - The colour of the value range changes to amber.
- ▶ Set the desired target temperature using the CircleSlider.
- ▶ Press «Start» to start the application.



Operation can only be started when the food probe is plugged in the socket in the appliance.

- ▶ Check and change the settings.
 - When cooking, the current food probe temperature is shown in the bottom part of the display next to the target temperature.
 - The set target temperature is displayed to the right of .
 - Operation ends automatically once the target temperature has been reached (see page 29).

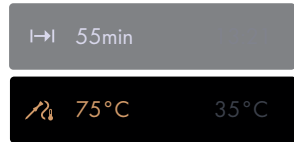

If the food is left in the cooking space after switching off the appliance, the food probe temperature can continue to rise due to residual heat.

Measuring the food probe temperature





To measure the food probe temperature only and without operation stopping automatically when the target temperature is reached, proceed as follows:

- ▶ Select the desired application (see page 17).
- ▶ Plug in the food probe.
- ▶ Press «Start» to start the application.

4.8 Options

Overview

Each application offers different options. Your appliance has the following  «Options»:

-  Preheating (see page 22)
-  Food probe temperature (see page 20)
-  Steaming (see page 32)
-  Start later (see page 23)

- Automatic door opening (see page 23) (depending on model)

Selecting and starting options

- ▶ Select an application from the desired application group and confirm with «OK», if required (see page 17).
 - The ready to start screen appears in the display.
- ▶ Touch .
 - The options menu appears in the display:

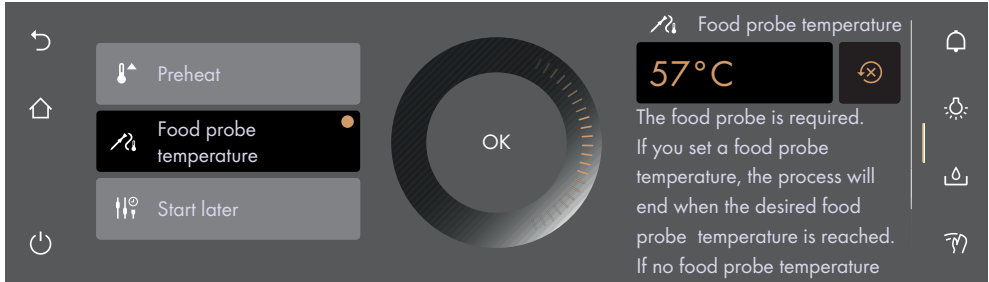

- ▶ Touch the desired option.
- ▶ In the right content pane of the display, either turn on the option with the switch or touch the value range and set the desired value using the CircleSlider.
 - Each defined option is marked with a .
- ▶ Confirm the setting with «OK».
 - Several settings can also be confirmed at once with «OK».
 - The ready to start screen appears in the display.
- ▶ Press «Start» to start the application.



 The «Food probe temperature» option can be set directly in the ready to start screen, if the food probe is plugged in.

4.9 Checking and changing the settings

Values and settings can be changed before and during operation. Exceptions are setting the end time  during operation (see page 29) and preheating (see page 22).

- ▶ Touch the field for the desired setting.
- ▶ To adjust or reset a value, touch the value range and adjust the value using the CircleSlider.
 - The colour of the value range changes to amber.
- ▶ To turn the option on or off, touch the switch.
- ▶ Confirm the setting with «OK».

4.10 Preheating

 **If the  «Preheat» option has been turned on, do not put the food into the cooking space until the acoustic signal is emitted and the corresponding message appears.**

With Preheat, the cooking space is quickly heated up to the desired temperature.

Overview

Preheating is only possible for the following applications:



-  Hot air
-  Professional baking flour-dusted

 Hot air with steaming

 Professional baking glazed

 Hot air humid

Turning on preheating in the options

- ▶ Select the desired application (see page 17).
- ▶ Touch  «Options» and select  «Preheat».
- ▶ Touch the «Preheat» switch.
 - «Preheating» is turned on.
- ▶ Set further options, if required (see page 21).
- ▶ Confirm the setting with «OK».
- ▶ Press «Start» to start an application requiring preheating.
 - «Preheating» starts.
 - The progress of «Preheating» is shown in the CircleSlider.



Introducing food

- As soon as the cooking space has preheated,
- an acoustic signal is emitted and a message is displayed. If set, the operating time does not start to run until the message has been acknowledged.
- ▶ Place the food in the cooking space.
 - ▶ Close the appliance door and confirm the message with «OK».
 - The application starts.

4.11 Setting to start later

With «Start later», an application and its settings can be predefined and set to start at a later time. The application does not start automatically, but instead only through the interaction of the user. The appliance remains ready to start and does not switch to standby, resulting in higher energy consumption.

Setting «Start later»

- ▶ Select the desired application (see page 17).
- ▶ Touch  «Options» and select  «Start later».
- ▶ Touch the «Start later» switch.
 - «Start later» is turned on.
 - The settings are saved for up to 36 hours.
- ▶ Set further options, if required (see page 21).
- ▶ Put the food in the cooking space if the «Preheat» option has not been turned on.

Starting «Start later»

- ▶ Press «Start» to start the application.
 - The application starts and the time remaining is displayed.



If both «End» and «Start later» have been set, the end time set is disregarded when starting «Start later».



4.12 Automatic door opening (depending on model)

With this option, the appliance door opens automatically when the set cooking time is up.



«Automatic door opening» can be enabled in the user settings as well as in the options. When this option is set, the appliance door opens automatically when the application selected is finished.

Setting «Automatic door opening»

- ▶ Select the desired application (see page 17).
- ▶ Touch  «Options» and select  «Automatic door opening».
- ▶ Touch the «Automatic door opening» switch.
- ▶ Set further options, if required (see page 21).
- ▶ Confirm the setting with «OK».
- ▶ Press «Start» to start the application.

4.13 Application tips

The application tips provide helpful suggestions that range from the use of suitable accessories or cookware to tips specific to a particular application.

If the application is not yet running:

- ▶ Select the desired application (see page 17).
 - The ready to start screen appears in the display.

Showing application tips

- ▶ Touch  «Application tips».
 - Tips on the particular applications are shown.



Hiding application tips

- ▶ To hide tips, touch .
 - The ready to start screen or the running operation appears in the display.

4.14 Favourites

Creating a favourite

Favourites can be created from all applications, with the exception of the cleaning programmes. And all options, with the exception of  «End», can be saved. Up to 50 favourites in total can be created.

- ▶ Select the desired application and adjust the values and settings (see page 17).
- ▶ Touch  «Favourites».
 - The favourite names menu appears in the display together with the keyboard.
- ▶ Customize the favourite name using the keyboard, if required.
- ▶ To discard favourites, touch .
- ▶ To save favourites, press «OK».
 - Quick information for the favourite is displayed.
 - The favourite **1** appears in the start screen as an app with a heart.





Changing favourites

Once a favourite has been created, it can no longer be changed.

- ▶ To adjust individual values or settings compared to the old favourite, create a new favourite and delete the old one if necessary.





Changing favourite names

The favourite name can only be changed in the app view.

- ▶ If required, touch 
 - The start screen appears as an app view.
- ▶ Press and hold the favourite **1**.
 - Quick information appears above the app.
- ▶ Touch  «Rename».
 - The favourite names menu appears in the display together with the keyboard.
- ▶ Change the favourite name using the keyboard.
- ▶ Touch  to keep the old favourite name.
- ▶ Press «OK» to save the new favourite name.

Deleting favourites

The favourite can only be deleted in the app view.

- ▶ If required, touch 
 - The start screen appears as an app view.
- ▶ Press and hold the favourite **1**.
 - Quick information appears above the app.
- ▶ Touch  «Clear».
 - The following appears in the display: «Do you really want to clear or reset?»
- ▶ To keep favourites, touch  «No».
- ▶ To delete favourites, touch  «Yes».

Starting favourites

- ▶ In the start screen, touch favourite **1**.
 - The ready to start screen appears in the display.
- ▶ Press «Start» to start favourite **1**.

4.15 Pinning

To permanently change the recommended main value for an application, it can be fixed with a pin . A single main value is assigned to each application. Main values can be:

- Temperature
- Temperature setting
- Food entry



The hygiene, BakeOmatic, RegenerateOmatic and recipe applications as well as plate warmer, desiccating (depending on model) and descaling cannot be pinned.

Pinning a main value

- ▶ Select the desired application (see page 17).
 - The ready to start screen appears in the display.
- ▶ Adjust the main value using the CircleSlider (see page 22).
- ▶ Press and hold the main value.
 - The colour of the pin changes to amber.
 - The main value for the desired application is fixed.
 - Whenever the application is called up, the pinned main value appears as a recommended value.

Resetting a pinned main value

- ▶ In the start screen, touch an application with a pinned main value.
 - The ready to start screen appears in the display.
- ▶ Press and hold the amber-coloured main value.
 - The colour of the pin changes to white.
 - The main value for the desired application is no longer fixed.
 - Whenever the application is called up, the recommended default value appears.



To reset all pinned main values, go to the user setting «Pinned values» (see page 51).

4.16 Timer

The timer functions like an egg timer. It can be used independently of other functions and applications.

Setting and starting the timer

- ▶ Touch the ⏰ «Timer» function button in the right function bar.
 - The timer is shown in the display.
 - The recommended value 1 appears in amber.
- ▶ Set the desired operating time using the CircleSlider.

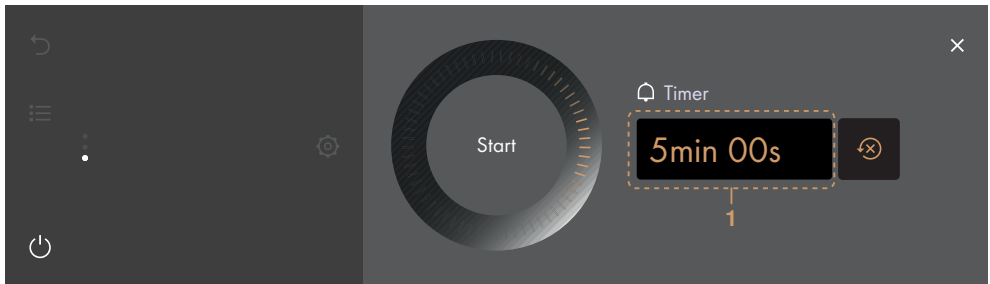

- ▶ Press «Start».
 - The start screen appears.
 - The countdown to the time remaining appears in the function bar.

When the duration is up

- an acoustic signal is emitted.
- «Timer finished» appears in the display.
- ▶ Press «OK» to confirm the message.

Checking and changing

- ▶ Touch the ⏰ «Timer» function button.
 - The countdown to the time remaining appears in the display.
- ▶ Press and hold «Stop».
 - The timer is interrupted.
- ▶ Shorten or extend the duration of the timer using the CircleSlider.
- ▶ Press «OK» to confirm the shortening or extending of the duration of the timer.
 - The change to the duration of the timer is saved.
 - The start screen appears.
 - The countdown to the time remaining appears in the display.



The next time the timer is called up, the last duration set automatically appears as the recommended value.

Turning the timer off before time

- ▶ Touch the  «Timer» function button.
 - The countdown to the time remaining appears in the display.
- ▶ Press and hold «Stop».



4.17 Illumination

The cooking space illumination can be switched on and off at any time.





The cooking space illumination switches on automatically 3 minutes before the set duration is up.

Switching the cooking space illumination on

- ▶ Touch the  «Illumination» function button.
 - The colour of the  function button changes to amber.
 - The cooking space illumination is switched on.

Switching the cooking space illumination off

- ▶ Touch the  «Illumination» function button.
 - The colour of the  function button changes to white.
 - The cooking space illumination is switched off.

4.18 Steam reduction

Steam reduction can be carried out manually by touching the  function button during operation. The steam is reduced by feeding water into the cooking space, making it possible to see into the appliance better or to add food that has a shorter cooking time.

Reducing the steam

- ▶ Touch the  «Steam reduction» function button.
 - The following appears in the display: «Eliminating steam.».



If, during this time, the appliance door is opened, steam reduction is significantly shortened.



Steam reduction takes about 1 minute.

- The following appears in the display: «Steam reduction completed. Appliance door can now be opened.»
- ▶ Open the appliance door and add more food, for example.
- ▶ Close the appliance door.
 - The selected process continues automatically.

4.19 Display lock

This function locks the display to, for example, enable the display to be cleaned or prevent accidental changes to the values. The appliance continues to operate and messages are still displayed.

Turning on the display lock

- ▶ Touch the  «Display lock» function button.
 - The following appears in the display: «Activate»
- ▶ Touch «Activate».
 -  appears in the display.

Turning off the display lock



- ▶ Press and hold .

- The display is unlocked.



4.20 Quiet mode

The appliance runs as quietly as possible when in quiet mode. All tones are set at the lowest volume. The quiet mode can be turned on and off in the user settings (see page 48) as well as by using the quick access in the function bar.

Turning on the quiet mode

- ▶ Expand the function bar.
- ▶ Touch the  «Quiet mode» function button.
 - The quiet mode is shown in the display.
- ▶ Touch the «Quiet mode» switch.
 - «Quiet mode» is turned on.
 - The colour of the  «Quiet mode» changes to amber in the function bars.

Turning off the quiet mode

- ▶ Expand the function bar.
- ▶ Touch the  «Quiet mode» function button.
 - The quiet mode is shown in the display.
- ▶ Touch the «Quiet mode» switch.
 - «Quiet mode» is turned off.
 - The colour of the  «Quiet mode» changes to white in the function bars.

4.21 Time

The clock can be shown at any time.

Showing the clock

- ▶ Expand the function bar.
- ▶ Touch the  «Clock» function button.
 - The clock is shown in the display.
 - If set, the operating time of an application is also shown.

Hiding the clock

- ▶ To hide the clock, touch **X**.
 - The clock is hidden in the display.

4.22 Cancelling / ending before time

Applications that are running can be cancelled or ended before time.

Cancelling an application

- ▶ Press and hold «Stop».



- The application is cancelled.
- A feedback tone is emitted, if enabled.
- Depending on the application, the following available options are displayed:
 - Confirm the question «Do you really want to end the application?» with ✓ «Yes».
 - Select one of the subsequent steps displayed to continue operation.
 - Select the ↶ function button to access the parent application menu.
 - Select the ⬆ function button to access the start screen (see page 17).
 - Press and hold the ⏻ function button to switch the appliance off (see page 31).



If the application has been running for less than 1 minute when cancelled, the ready to start screen appears.

Ending an application before time

- ▶ Press and hold the ⏻ function button.
 - Any running application is ended; if switched on, the timer will remain active.
 - If turned on, the display lock is deactivated.
 - For applications with steam, the steam is eliminated.
 - The appliance switches off (see page 31).

4.23 End of operation

When the set duration / the step duration is up or when the set target temperature is reached.

- The application ends automatically.
- An acoustic signal is emitted.
- If subsequent steps are available, the following appears in the display: «The operation has finished. Do you want to proceed with a subsequent step?»
- ▶ Press «No» to end operation now.
- ▶ Press «Yes» to confirm the message.
 - Depending on the application, the following available options are displayed:
 - Select one of the subsequent steps displayed to continue operation.
 - Select the ↶ function button to access the parent application menu.
 - Select the ⬆ function button to access the start screen (see page 17).
 - Press and hold the ⏻ function button to switch the appliance off (see page 31).

In EcoStandby as long as the temperature in the cooking space is over 80° C.

- In the display appears: «Residual heat in the cooking space». The actual cooking space temperature is also displayed.

In EcoStandby if the food probe is plugged in.

- The food probe temperature is displayed.



The food can be kept warm with residual heat for some time. As soon as the temperature falls below 80 °C, all the displays go out. If at this point the food probe is still plugged in, the displays only go out when the food probe is unplugged. The cooling fan can continue to run.

After 3 minutes without interaction.

- The display goes dark and the appliance switches off automatically (see page 31).

Removing the cooked food from the cooking space



Risk of burns!

Hot steam or hot air may escape from the cooking space when the appliance door is opened. The accessories get hot. Use protective gloves or oven cloths.

- ▶ Take the food out of the cooking space when done.
- ▶ Any condensate or food particles in the cooking space must be completely removed after each cooking session with steam.
- ▶ Clean the filter.
- ▶ Wipe away traces of water or soiling with a soft cloth to prevent corrosion and unpleasant odours.
- ▶ Leave the appliance door open in the airing position until the cooking space has cooled down and dried out.

4.24 End of operation when AutoDoor is on (depending on model)

If «Automatic door opening» is enabled, the appliance door opens automatically when the duration set is up or when the food has reached the desired food probe temperature.

4.25 Subsequent steps

Subsequent steps are applications that can be used to continue operation after an application has ended or been cancelled. Operation can be extended for the application that has just ended. The selection of subsequent steps available depends on the application that has just ended or been cancelled.



If «Automatic door opening» is enabled, when an application ends no subsequent steps appear in the display. Instead, the appliance door opens.

When an application ends or is cancelled and the message «The operation has finished. Do you want to proceed with a subsequent step?» is confirmed with «Yes» (see page 29),

- the subsequent step available for selection appears in the display:





Continuing operation

- ▶ Select the desired subsequent step.
 - With subsequent step **1**, the application just ended or cancelled is resumed. The main value (temperature or temperature setting) is taken over directly from the application that has ended or been cancelled.
- ▶ Confirm the selection with «OK».
 - The ready to start screen with reduced setting options appears in the display.
- ▶ If required, touch  and set the options (see page 21).

- ▶ Press «Start» to start the subsequent step.

Cancelling operation

To cancel operation, the following options are available:

- Select the  function button to access the start screen (see page 17).
- Press and hold the  function button to switch the appliance off (see page 31).

After 3 minutes without interaction.

- The display goes dark and the appliance switches off automatically (see page 31).

4.26 Switching the appliance off

- ▶ Press and hold the  function button.
 - Any running application is ended; if turned on, the timer will remain active.
 - If turned on, the display lock is deactivated.
 - For applications with steam, the steam is eliminated.
 - The display goes dark.
 - The appliance is in EcoStandby.

Display after switching off

Depending on the application and settings, the following is shown in the darkened display.

- The residual heat and the temperature if it is above 80 °C.
- The food probe temperature if the food probe is still plugged in.

4.27 Appliance tips

Appliance tips provides tips on operating the appliance by topic.

Topics

The following topics can be called up:

- Start screen
- Function bars
- CircleSlider
- App view
- List view
- Food probe
- AutoDoor (depending on model)
- Favourites
- Pinning
- EasyCook
- Cleaning
- Preheating

Calling up appliance tips

- ▶ In the start screen, touch  «Appliance tips».
 - The appliance tips menu appears in the display.
- ▶ Select the desired topic.
 - Information on the desired topic appears in the right content pane of the display.

5 Applications

5.1 Hot air



Temperature range	30–230 °C
Recommended value	180 °C
Level	2 or 1 + 3

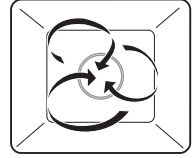

A heating element behind the back wall of the cooking space heats up the air inside the cooking space, which is circulated evenly.

Uses

- For cakes, savouries, biscuits, bread and roasts on 1 or 2 levels



Select a lower temperature (reduce by approximately 20 °C) than for top/bottom heat as the heat transfer is more efficient.

5.2 Hot air humid



Temperature range	30–230 °C
Recommended value	180 °C
Level	2 or 1 + 3

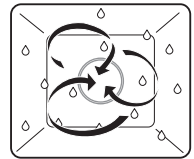

A heating element behind the back wall of the cooking space heats up the air inside the cooking space, which is circulated evenly. The natural humidity produced is largely retained in the cooking space. The food retains its moisture.

Uses

- Roasts, braised dishes and gratins



Select a lower temperature (reduce by approximately 20 °C) than for top/bottom heat as the heat transfer is more efficient.

5.3 Hot air with steaming



Temperature range	80–230 °C
Recommended value	180 °C
Level	2 or 1 + 3

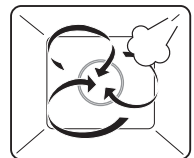

The cooking space is heated by hot air. Bursts of steam ensure that the energy is transferred more efficiently to the food. This speeds up the cooking process slightly and the food comes out really crispy.



Steam over 100° C is not visible.

Uses

- Puff pastries, yeast pastries, bread, plaited bread

- Baked dishes and gratins
- Meat
- Frozen and convenience foods



Particularly suitable for low-fat cooking of frozen foods such as oven chips and spring rolls.

Using the  option, the supply of steam can be turned off and on again during operation.

5.4 Hot air eco



Temperature range	30–230 °C
Recommended value	180 °C
Level	2 or 1 + 3

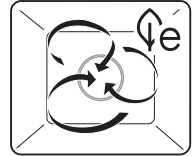

This application is particularly energy-efficient. A heating element behind the back wall of the cooking space heats up the air inside the cooking space, which is circulated evenly. Any moisture that escapes from the food is retained in the cooking space, so the food dries out less.

Uses

- Roasts, gratins, savouries and biscuits



Do not preheat when using this application to cook. This lowers the energy consumption. The cooking time can be longer than with classical hot air.



The temperature is optimized throughout in this application for energy-saving cooking, and this is indicated in the display during operation with «ECO».



Select a lower temperature (reduce by approximately 20 °C) than for top/bottom heat as the heat transfer is more efficient.

5.5 Steam



Temperature range	30–100 °C
Recommended value	100 °C
Level	1 to 4

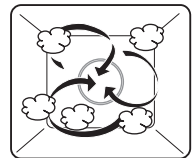

The cooking space is heated simultaneously by steam and hot air. The food is heated up or cooked by steaming.

Uses

- Steaming vegetables, rice, cereal products, pulses and egg dishes
- Poaching meat, poultry and fish
- Extracting juice from fruit and berries
- Making yogurt
- Preserving, bottling



Possible to steam on several levels simultaneously.

5.6 Regeneration



Temperature range	80–200 °C
Recommended value	120 °C
Level	1 to 4

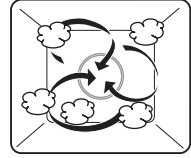

The cooking space is heated by steam and hot air. The food is reheated gently without drying it out.

Uses

- Reheating pre-cooked foods and convenience foods



Possible to regenerate on several levels simultaneously.



For crispier results (e.g. to crisp up bread and flans), set a higher temperature (150–180 °C).

5.7 Desiccating (depending on model)



Temperature range	40–85 °C
Recommended value	65 °C
Level	2 or 1 + 3



A heating element behind the back wall of the cooking space heats up the air inside the cooking space, which is circulated evenly. The appliance door opens automatically at regular intervals to allow moisture from the food to escape. The food dries out slowly.

Uses

- For drying fruit, berries, vegetables and herbs



The lower the drying temperature, the longer the drying time. Food with a high water content requires a longer drying time.

5.8 Vacuisine

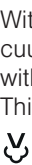

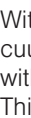
With  «Vacuisine», meat, fish, vegetables and fruit can be prepared sous vide. The vacuum-packed food is gently steamed. The food probe temperature can be monitored with the food probe. The food probe temperature is the set cooking space temperature. This ensures that the food is cooked to the same degree of doneness throughout.

Temperature range	30-95 °C
Recommended value	60 °C
Level	1 to 4
Recommended maximum cooking time	72 hours

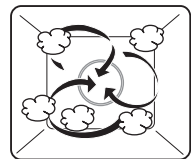

The cooking space is heated simultaneously by steam and hot air. The food is heated or cooked by steam.

Tips for best results

- Only use fresh food. This applies to meat and fish in particular. Food that has already been kept for some time has a higher bacterial content and is therefore unsuitable for Vacuisine.
- Meat quality: both lean (e.g. fillet) and marbled, more sinewy (e.g. stewing meat and belly pork) cuts of meat can be prepared optimally using Vacuisine.

Preparing the food

- Vacuum seal the food. For this, see the tips in the operating instructions for the vacuum drawer, on the homepage or in the recipe brochure.
- To monitor the food probe temperature of the meat with the food probe, the spot where the food probe punctures the vacuum bag must be sealed with a sealing pad. This ensures that the vacuum is maintained in the bag.
- ▶ Attach a sealing pad to the bag containing the vacuumed food, having first ensured that the bag is clean and dry.
- ▶ Insert the food probe through the sealing pad and the bag, and into the meat. The tip of the food probe should be inserted into the centre of the thickest end of the meat.

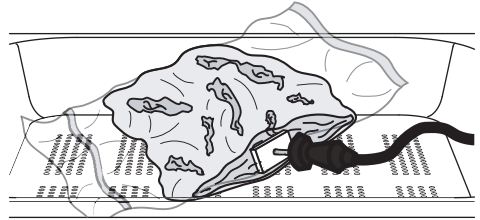

Selecting and starting Vacuisine

- ▶ Put the perforated cooking tray into the cooking space and place the vacuum-sealed food in it.





Ensure that the bags are adjacent and not overlapping so that the steam can circulate and cook the food evenly.



The filled water tank must be in position in the water tank compartment. For long cooking times, the water tank may need to be refilled. A corresponding message will appear.



If the desired cooking time is longer than 10 hours, place the stainless steel tray underneath the perforated cooking tray.

- ▶ If needed, plug the food probe into the appliance.
- ▶ Long touch the display.
 - The appliance starts and the start screen appears.
- ▶ Select the  «Vacuisine» application and confirm with «OK», if required (see page 17).
 - The settings for Vacuisine appear in the display.
- ▶ Make any desired settings (see page 22).
- ▶ Press «Start» to start  «Vacuisine».



With the  «Vacuisine» application, the food probe only serves to monitor the food probe temperature. It is not possible to set the food probe temperature.

Monitoring the food probe temperature using the food probe

- ▶ When the food probe temperature and the cooking space temperature are roughly the same:
 - an acoustic signal is emitted.
 - in the display appears: «Food has reached food probe temperature.»
 - the meat is cooked. The operation is not cancelled.

- the meat can be left in the appliance for up to an hour.
- ▶ If the cooking time is accidentally set too short and is up before the food probe temperature has been reached:
 - the operation is not cancelled.
 - an acoustic signal is emitted.
 - in the display appears: «Food has not yet reached food probe temperature. Operation will continue.».

5.9 Professional baking

With  «Professional baking», the steam and drying phases are controlled automatically. The process is tailored to whatever is being baked. Depending on the application used, a shiny or rustic crust is produced.



With «Professional baking classical», the settable temperature corresponds to that of the hot air phase. The temperature during the steam phase is preset.

For a nice, crispy crust: the smaller the item to be baked, the higher the temperature. The optimum temperature for bread buns is generally higher than for a single loaf of bread.

Professional baking comprises the following application areas:

Flour-dusted

 «Professional baking flour-dusted» has a longer steam phase at the beginning, which is followed by a hot air phase. It is particularly suitable for bread loaves and rolls with a good crust. It is recommended that the appliance be preheated before starting this application.

Glazed

 «Professional baking glazed» is suitable for baked goods such as plaited bread and puff pastries that have been glazed with an egg wash or another liquid. The process prevents the egg wash running and gives a shiny finish. It is recommended that the appliance be preheated before starting this application.

Classical

 «Professional baking classical» is based on a process that gives pastries, e.g. puff pastries, a shiny finish, without the need for an egg or other wash. It starts with a cold cooking space and a steam phase. This is followed by a hot air phase.



The appliance door must not be opened during the steam phase. If the appliance door is opened while professional baking is running, this will extend the steaming phase and the bread will be oversteamed. The bread comes out flatter as a result.

Proofing

«Professional baking proofing» allows raw and shaped dough to rise in an ideal controlled atmosphere. The temperature is automatically regulated to the set temperature and humidity.

Selecting and starting professional baking

- ▶ Long touch the display.
 - The start screen appears.
- ▶ Select the  «Professional baking» application group and confirm with «OK», if required (see page 17).
- ▶ Select the desired application and confirm with «OK».

- The settings for the application appear in the display.
- ▶ Set the temperature and operating time, if required.
- ▶ Put in the food.
- ▶ Press «Start» to start Professional baking.



With «Professional baking flour-dusted» and «Professional baking glazed», put the food in after preheating has ended. A corresponding message will appear. The food can now be put into the cooking space and the message confirmed. The process starts.

5.10 Soft roasting

How it functions

The  «Soft roasting» function allows high-quality cuts of meat to be prepared gently. The end of operation can be set precisely, irrespective of the weight and thickness of the meat. The temperature is automatically controlled. For long operating times, the temperature is controlled such that it corresponds to low-temperature cooking.

Depending on the type of meat, the cooking time can be set between 1½ and 4½ hours.

Tips for best results

- Take the meat out of the refrigerator some 30–60 minutes before soft roasting.
- Weight of meat: 500–2000 g
- Meat thickness: at least 4 cm
- Quality: high-quality (not too aged) meat
- Select a long cooking time for marbled cuts of meat such as shoulder or neck.

Soft roasting table for «Soft roasting seared»

Cut of meat	Degree of doneness	Recommended target temperature °C
Fillet of veal	medium	59
	well done	65
Rump or loin of veal	medium	63
	well done	69
Shoulder of veal	well done	75
Neck of veal	well done	75
Veal topside	medium	61
	well done	71
Veal breast	well done	75
Fillet of beef	rare	48
	medium rare	53
	medium	57
	well done	65
Sirloin, striploin	medium	57
	well done	64
Rump of beef	medium	63
	well done	69

Cut of meat	Degree of doneness	Recommended target temperature °C
Rib-eye or prime rib of beef	medium	60
	well done	68
Shoulder of beef	medium	72
	well done	75
Rump or loin of pork	medium	61
	well done	72
Neck of pork	well done	76
Shoulder of pork	well done	76
Leg of lamb	medium	65
	well done	74

Soft roasting seared

- ▶ Season or marinate the meat.

 Remove any marinade made with herbs, mustard, etc. from the meat before searing. These constituents easily burn.

- ▶ Salt the meat immediately before searing.
- ▶ Briefly sear the meat on all sides for no longer than 5 minutes.
- ▶ Then place the meat on the wire shelf.

 The meat can also be browned after cooking. This has little effect on the degree of doneness of large cuts of meat. For small cuts of meat, the target temperature should be reduced by 2–3 °C.

- ▶ Insert the food probe into the meat so that the tip is in the centre of the thickest part.

 The food probe must be inserted as far into the middle of the meat as possible to get a correct reading of the food probe temperature. The temperature inside the meat is crucial for optimal results at the end of cooking.

- ▶ Put the wire shelf with the meat at level 2 and a baking tray, which has been lined with aluminium foil, at level 1.
- ▶ Insert the food probe plug into the socket.
- ▶ Start  «Soft roasting seared».

Selecting and starting soft roasting

 Once the programme has started it is no longer possible to change the target temperature.

- ▶ Long touch the display.
 - The start screen appears.
- ▶ Select the  «Soft roasting» application group and confirm with «OK», if required (see page 17).
- ▶ Select the desired type of meat.
- ▶ Select the desired cut of meat.
- ▶ Select the desired soft roasting method and confirm with «OK».



▶ If the desired type of meat or cut are not available for selection, select «Freely select meat type».

- ▶ Select the degree of doneness (not possible for «Freely select meat type»).
 - The settings for the application appear in the display.
- ▶ Adjust the recommended value, if necessary, and set a delayed start if desired (see page 20).
- ▶ Press «Start» to start soft roasting.



The food probe must be plugged in.

- Soft roasting starts.
- The set target temperature, the current food probe temperature and the countdown to the time remaining are displayed.

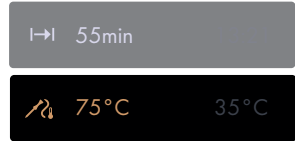

The appliance door must be kept closed during operation. If the appliance door is opened while soft roasting is running, the operation is interrupted and then, after a short time, cancelled.

Cancelling / ending soft roasting before time

- ▶ Press and hold «Stop» to cancel soft roasting.
 - The following appears in the display: «Do you really want to cancel the application?»
- ▶ To cancel or turn off soft roasting before time, touch ✓ «Yes».
 - The operation is cancelled.
- ▶ Press and hold the ⏻ function button to switch the appliance off (see page 31).



If you accidentally pressed «Yes» but still want to finish cooking the meat, you must select another application.
«Soft roasting» is not suitable for pre-cooked meat.

5.11 Keep warm

Cooked foods can be kept warm using  «Keep warm».



If the cooking space is already hot, open the appliance door and allow the cooking space to cool down for about 10 minutes before starting the «Keep warm» function. This ensures that the food does not overcook. The longer the food is kept warm, the greater the changes may be to the consistency of the food.

5.12 Warming plates in the cooking space



If the cooking space is already hot, open the appliance door and allow the cooking space to cool down for 3 to 4 minutes before starting the «Plate warmer» function. This is to protect the tableware from damage through stress cracking.

- ▶ Long touch the display.
 - The start screen appears.
- ▶ Place the tableware in the cooking space.
 - Ideally, put the wire shelf in and place the tableware on it.
- ▶ Touch the  «Plate warmer» application.

- The duration and the calculated end time appear in the display.
- ▶ Set an end time or a delayed start, if required (see page 20).



Select a duration of at least 30 minutes.

- ▶ Press «Start» to start «Plate warmer».
 - The «Plate warmer» ends automatically when the set duration is up.



The plates will be hot. Use protective gloves or oven cloths.

5.13 Wellness

With  «Wellness», the following objects can be prepared for personal well-being:



Refreshing towels



Hot massage stones



Hot wraps



Seed cushions



Caution hot!

Feel the temperature of the heated objects with your hand first before placing them on any other parts of the body.

Refreshing towels

Before starting the application:

- ▶ Wet and wring out the towels.
- ▶ Open the towels and place in the perforated cooking tray or:
- ▶ Roll up the towels to the desired size and place in the perforated cooking tray.

Hot wraps

Before starting the application:

- ▶ Spread the prepared towels out across the perforated cooking tray.

Hot massage stones

Before starting the application:

- ▶ Put the clean, smooth massage stones in a suitable container and place it directly on the floor of the cooking space.

Seed cushions

Before starting the application:

- ▶ Place the cherry stone or grape seed cushions in the perforated cooking tray.

5.14 Hygiene

 «Hygiene» can be used for sanitizing containers. The following applications are available:



Hygiene baby bottles



Preserve jam



Hygiene preserving jars

Hygiene baby bottles

This application replaces the need to boil feeding bottles in water.

Before starting the application:

- ▶ Clean the bottles.
- ▶ Unscrew the bottles and place all parts into the perforated cooking tray.

After the application has finished:

- ▶ Stand the bottles upside down on a clean kitchen towel and allow to dry thoroughly.

Hygiene preserving jars

This application replaces the need to prepare empty jars by rinsing them with hot water.

Preserve jam

This application helps to preserve the jam for longer.

5.15 BakeOmatic

Ä «BakeOmatic» comprises applications for different food groups. The size and shape of the food are recognised and the duration and cooking space climate are adjusted automatically.

Degree of browning

For selected food groups, the degree of browning can be adjusted by selecting the «Lightly browned», «Medium browned» or «Well browned» setting.

Duration

When BakeOmatic starts, the optimum cooking time is determined automatically. The effective duration is displayed after about 10–15 minutes.



Before starting, the cooking space must have cooled down and be dry in order to determine the optimum cooking time.



The appliance door must not be opened whilst the duration is being determined. Otherwise, the optimum cooking time and temperature will not be calculated correctly.

Selecting and starting BakeOmatic



A delayed start is only suitable for food that does not need to be refrigerated or to rise.

- ▶ Long touch the display.
 - The start screen appears.
- ▶ Select the Ä «BakeOmatic» application group and confirm with «OK», if required (see page 17).
- ▶ Select the desired food group and confirm with «OK».
 - The settings for the desired application appear in the display.
- ▶ Set an end time →| or a delayed start |→|, if required (see page 20).
- ▶ Press «Start» to start the application.
 - The following appears in the display: «Determining operating time».
 - The countdown to the time remaining appears in the display.



5.16 RegenerateOmatic

How it functions

With RegenerateOmatic, food can be heated without setting a temperature or operating time. The quantity and shape of the food are detected and the regeneration time and cooking space climate are adjusted individually and automatically to the food.

Degree of moisture



With RegenerateOmatic, choose between ☹ «RegenerateOmatic humid» and ☺ «RegenerateOmatic crispy».

Degree of moisture	Uses
	Foods that should not dry out e.g. vegetables, meat, pasta, rice
	Foods that should be crispy after regeneration e.g. pizza, flans, aperitif nibbles, gratins, breadcrumbed products

Regeneration time

Sensors detect when the food is hot.

The approximate duration for the most frequently used applications is:



-  «RegenerateOmatic humid»: 10–16 minutes
-  «RegenerateOmatic crispy»: 12–18 minutes

Selecting and starting RegenerateOmatic



Before starting, the cooking space should have cooled down and be dry in order to determine the optimum duration.

The appliance door should not be opened during operation.

- ▶ Put the food in a heat-resistant dish, place it on the wire shelf and push it into the cold cooking space.
 - It is recommended that an enamelled tray be used with  «RegenerateOmatic crispy».
- ▶ Long touch the display.
 - The start screen appears.
- ▶ Select the  «Regeneration» application and confirm with «OK», if required (see page 17).
- ▶ Select the desired application and confirm with «OK».
 - The settings for the application appear in the display.
- ▶ Set an end time or a delayed start, if required (see page 20).
- ▶ Set to start later, if required (see page 23).



An estimated average regeneration time is used to calculate the delayed start. Regeneration can therefore also be ended earlier or later.

- ▶ Press «Start» to start «RegenerateOmatic».



The operation cannot be extended when regeneration finishes.

5.17 Recipe book

The following recipe book is available for this appliance:

- «Steaming. With a passion for detail.»

Recipes that are tailored to your appliance can be found in the recipe book. They are pre-programmed in the appliance and once started run automatically.

Starting a recipe



For recipes that do not require preheating, place the food in the cold cooking space.

- ▶ Long touch the display.
 - The start screen appears.
- ▶ Select the  «Recipes» application group and confirm with «OK», if required (see page 17).
- ▶ Select the desired recipe book.

- ▶ Select the desired chapter.
- ▶ Select the desired recipe and confirm with «OK».
 - The settings for the recipe appear in the display.
 - Set an end time or a delayed start, if required (see page 20).
- ▶ To view the individual recipe steps, open the overview of the steps in the left content pane of the display. Select «1. Step». The overview of the steps opens and information on each step such as the application, temperature and operating time can be viewed. The action information contains instructions on what actions need to be taken.
- ▶ To start the recipe from a particular step, select that step or action and confirm with «OK». That step is applied to the ready to start screen and the recipe can be started as usual by touching «Start».
- ▶ A recipe can be started from any step, i.e. steps can be skipped.



If you want to start the recipe from a later step, select the action before it to get information about shelf position.



There are steps and actions. Steps are preheating or cooking steps, actions are instructions on what actions need to be taken.

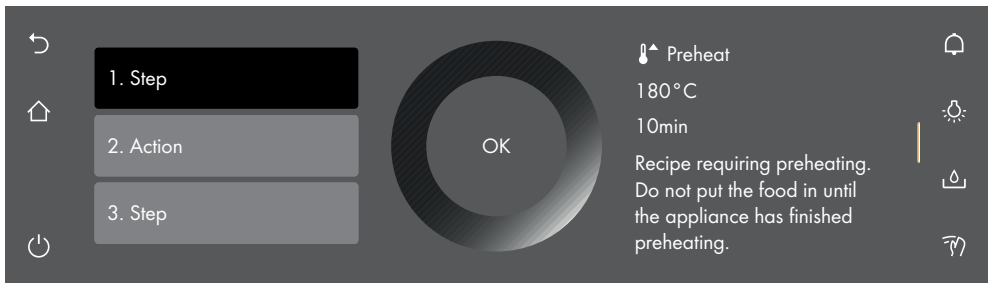

While the recipe is running

While the recipe is running, it may be necessary to open the appliance door, e.g. to turn the food over or to put in more food. In such an instance, operation is paused and the display shows instructions on what to do next.

To continue the recipe, proceed as follows:

- ▶ Open the appliance door.
- ▶ Carry out the action, e.g. turn over food.
- ▶ Close the appliance door and confirm the message with «OK».
 - The recipe will continue to run.

Cancelling a recipe

- ▶ Press and hold «Stop» to cancel the recipe.
 - The following appears in the display: «Do you really want to cancel the application?»
- ▶ Touch ✓ «Yes» to cancel the recipe.
 - The recipe is cancelled.

5.18 Own recipes

Up to 40 of your own favourite recipes can be created and saved. A recipe can consist of several steps with specific applications, preheat, pauses and hold times, which run automatically once started. You can also change and save existing recipes.



With «Preheat», the cooking space is heated to the temperature selected in the following step. This temperature is maintained until the food is put in and confirmed with «OK».

With «Hold», the cooking space continues to be heated and the temperature remains constant.

With «Pause», the cooking space is not heated any more and the temperature goes down.

Creating your own recipe

- ▶ Long touch the display.
 - The start screen appears.
- ▶ Touch .
- ▶ Touch «Own recipes».
- ▶ Touch «Create recipe».
 - The selection «Add step» appears.
- ▶ Touch «Add step».
 - The selection options appear.
- ▶ Select desired application or «Preheat», «Pause» or «Hold» and confirm with «OK».
- ▶ Make the desired settings for each step.
 - Set the temperature or temperature level.
 - Set the operating time.
 - Set «Preheat» if the cooking space needs to be heated up to a desired temperature.
 - Set «Food probe» if a specific food probe temperature needs to be reached.
- ▶ Confirm with «OK».
- ▶ Create additional steps in the same way.



The maximum number of steps that can be created in an own recipe is ten.

Naming a created recipe

- ▶ Use the keypad to enter the name of the recipe.
- ▶ Confirm with «OK».
 - The new recipe is now displayed in the «Own recipes» screen.

Starting a recipe

- ▶ Select the desired recipe and confirm with «OK».
 - The settings for the recipe appear in the display.
- ▶ Press «Start» to start the recipe.

Changing an own recipe

Recipes that are in Own recipes can be changed.

- ▶ Select the required recipe.
- ▶ Touch .
- ▶ The «Edit recipe» screen appears.



Changing a step

- ▶ Touch the step to be changed.
- ▶ Make the settings and confirm with «OK».

Adding a step

- ▶ Touch + «Add step».
- ▶ Make the settings and confirm with OK.

Deleting a step

- ▶ For the desired step, touch .
 - The following appears in the display: «Are you sure you want to delete this step?»
- ▶ To delete the step, touch .
 - The step is deleted.

Saving a changed recipe

- ▶ Confirm with «OK».
- ▶ Give the changed recipe a name.
- Use the keypad to enter the name of the new recipe.
- ▶ Confirm with «OK».

Copying an own recipe

- ▶ Touch «Own recipes».
- ▶ Select the required recipe.
- ▶ Touch .
 - Each existing step can now be changed.
 - Extra steps can also be added.
- ▶ Confirm with «OK» and give a name to and save the new recipe.



Copying a recipe

Recipes can be copied from the recipe book.

- ▶ Touch the recipe book.
- ▶ Select the required recipe.
- ▶ Touch .
 - Each existing step can now be changed.
 - Extra steps can also be added.
- ▶ Confirm with «OK» and give a name to and save the new recipe.

Deleting your own recipe

Recipes that are in Own recipes can be deleted.

- ▶ Select the required recipe.
- ▶ Touch .
 - The following appears in the display: «Are you sure you want to delete the recipe?»
- ▶ To delete the recipe, touch .
 - The recipe is deleted.

5.19 EasyCook

‡ EasyCook helps you to prepare any food simply and conveniently. After choosing the food group and food, the appliance suggests suitable applications, including settings and accessories.

Overview of food groups

Foodstuffs are grouped into different categories; a foodstuff may be included in more than one group.

The following food groups can be selected:

Baked dishes and gratins	Meat
Bakery products	Fruit and berries
Accompaniments	Poultry

Desserts

Eggs

Fish and seafood

Vegetables

Dairy products

Flans and pizzas

Selecting and starting foods



A delayed start is only suitable for food that does not need to be refrigerated or to rise.

- ▶ Long touch the display.
 - The start screen appears.
- ▶ Select the  «EasyCook» application and confirm with «OK», if required (see page 17).
- ▶ Select the desired food group.
- ▶ Select the desired type of food.
- ▶ Select the shape (whole, in pieces, etc.) of the food and confirm with «OK», if required.
- ▶ Select the preparation method (cooking, baking, etc.) and confirm with «OK», if required.
 - The settings for the chosen food appear in the display.
- Make any desired settings (see page 22).
- Press «Start» to start operation.

Dietary styles

In the user settings in the section «Individual settings» under «EasyCook – dietary style», certain foods and/or food groups can be deactivated so that EasyCook can be adapted to suit a personal dietary style.

The following foods are available:

Milk

Eggs

Fish

Meat

Pork

All activated foodstuffs are highlighted in amber. They can be deactivated by touching the switch.

Only where this is clear, are foods excluded. For example, if «Milk» is excluded, only foods and dishes that clearly contain «Cow's milk» will be hidden. Any number of dietary styles can be excluded.

Cuisines from around the world

In the user settings in the section «Individual settings» under «EasyCook – cuisines from around the world», country- and region-specific foods and basic dishes along with their preparation methods can be activated as a package.

The following national cuisines are available:

- Italian
- French
- German
- Lebanese
- Chinese
- Australian
- Ukrainian
- Turkish
- Belgian
- Russian

All activated national cuisines are highlighted in amber. They can be deactivated by touching the switch.

The activated foods and basic recipes in each packet are then integrated into the structure of the EasyCook menu. Any number of national cuisines can be activated.

6 V-ZUG-Home



Download updates to your appliance via V-ZUG-Home so that you are always up to date.

Hereby, V-ZUG Ltd declares that the radio equipment type is in compliance with Directive 2014/53/EU. The full text of the EU declaration of conformity is available at the following internet address: <https://www.vzug.com/gb/en/guidance-for-testing-institutes>

6.1 Conditions

The following conditions must be met for full use of V-ZUG-Home:

- Access to the internet and to Google Play™ Store / App Store®
- Smartphone or tablet that is connected to the home network
- WLAN/Wi-Fi that meets one of the following standards: 2.4GHz 802.11 b/g/n



Google Play™ is a trademark of Google Inc.



Apple and the Apple logo are trademarks of Apple Inc., registered in the U.S. and other countries. App Store® is a service mark of Apple Inc.

6.2 Initial set-up



When establishing a connection, stay close to your household appliance and have the password for your wireless network at the ready.

Installing the app

- ▶ Enable bluetooth and location determination on the smartphone or tablet.
- ▶ Search the Google Play™ Store or the App Store® for «V-ZUG».
- ▶ Install and open the V-ZUG App.

Enabling the V-ZUG-Home mode on the appliance

- ▶ Set to the «Display» or «Operate and display» mode under «V-ZUG-Home» in the user settings.

Connecting the appliance to the home network



- ▶ In the V-ZUG App, add the household appliance.
 - A bluetooth pairing request appears in the V-ZUG App.
 - A 6-digit PIN appears in the display of the household appliance.
- ▶ Enter the 6-digit PIN in the V-ZUG App and confirm the bluetooth pairing request.
 - The name of the active WLAN/Wi-Fi appears in the V-ZUG App and then you are prompted to enter the WLAN/Wi-Fi password.
- ▶ Enter the WLAN/Wi-Fi password.
 - The household appliance is connected to the active WLAN/Wi-Fi connection.



Further information on V-ZUG-Home and its availability can be found at vzug.com.

7 User settings

7.1 Adjusting user settings

- ▶ Long touch the display.
 - The start screen appears.
- ▶ Select  «User settings» and confirm with «OK», if required (see page 17).
- ▶ Select the desired user setting.
 - The main menu for the desired user setting or another submenu with more user settings appears in the display.
- ▶ Make the desired setting.
 - The setting is applied immediately.
- ▶ To exit a submenu, touch .
- ▶ To exit the user settings, touch .



All user settings except for the quiet mode are retained in the event of a power interruption or failure.

7.2 Language

The language in the display can be changed. Different languages are available for selection.

7.3 Childproof lock

The childproof lock is to prevent children accidentally switching on the appliance. When the childproof lock is activated, the appliance can only be operated after first entering a code. The code is displayed in reverse order when unlocking.



The childproof lock is activated within 1 minute of the appliance being switched off.

7.4 Display

Colour scheme

It is possible to choose between a light or dark colour scheme for the display.

Brightness

The brightness of the display can be changed.

Background

The background of the display can be changed. Choose whether to display a solid colour, a texture or a texture featuring various ingredients in the background. When a texture with ingredients is selected, images of different ingredients are displayed on every page in the app view.

7.5 Signals and tones

Quiet mode

The appliance runs as quietly as possible when in quiet mode. All tones are set at the lowest volume. This setting is deactivated when the appliance goes into the EcoStandby mode. The volume of the feedback tones and acoustic signals cannot be changed when in quiet mode.

Sound worlds

The tonality of the acoustic signals and feedback tones can be changed.

Feedback tones

The volume of the feedback tones can be adjusted up or down or turned off completely. Certain feedback tones are not muted for legal and safety reasons.



A short feedback tone is emitted when the appliance is switched off even if the setting is set to «Off» (safety function).

Acoustic signals

The volume of the acoustic signals can be adjusted up or down. They cannot be turned off.



Touch anywhere on the display or open the appliance door to stop an acoustic signal.

7.6 Individual settings

EasyCook – dietary style

Certain foods and food groups can be deactivated so that EasyCook can be adapted to suit a personal dietary style.

EasyCook – cuisines from around the world

Country- and region-specific foods and basic dishes along with their preparation methods can be activated as a package and added to EasyCook.

Start screen

Choose whether the applications should be displayed in the app view or the list view when the start screen is called up.

Subsequent steps

If set to «On», subsequent steps are displayed at the end of operation. If set to «Off», operation is immediately ended.

Temperature unit

The temperature can be displayed in «°C» or «°F».

- °C: Degrees Celsius
- °F: Degrees Fahrenheit

Water hardness

The appliance is equipped with a system that automatically indicates when it is time to descale. The system can be optimized for households with soft water (also through using a water softening appliance) and medium water hardness by changing the user settings to the relevant range of water hardness.

There are 4 setting ranges for water hardness:

Type	Water hardness °fH	Water hardness °dH	Water hardness °eH
Very hard	>38°	>21°	>27°
Hard	27–38°	16–21°	19–27°
Medium	16–26°	9–15°	12–18°

Type	Water hardness °fH	Water hardness °dH	Water hardness °eH
Soft	1–15°	1–8°	1–11°

7.7 Assistance functions

Water compartment flap

If set to «On», the flap of the water tank compartment opens automatically when the water tank is empty and water is required for operation.

Illumination

If set to «On», the cooking space illumination pulses when there is a new message during operation.



Touch the  symbol to switch the illumination on or off at any time.

If the illumination is not switched off, it will go off automatically within 3 minutes to save energy.

Automatic door opening (depending on model)

If set to «On», the appliance door opens automatically when the duration set is up or when the food has reached the desired food probe temperature (see page 30).

Automatic door closing (depending on model)

If set to «On», the appliance door closes when the «Start» button for an application is pressed.

Preheat tone

If set to «On», a short preheat tone is emitted when it is time to put the food into the cooking space.

7.8 Date and time

Time synchronization

The «Internet» setting is set automatically when connecting to V-ZUG-Home. The time, date and time zone are then synchronized directly from the app.

Date

The date can be called up and changed.

Time

The time can be called up and changed.

Date and time format

The time can be displayed in the European 24-hour or the US 12-hour format (a.m./p.m.).

The date can be displayed in the DD.MM.YYYY, YYYY-MM-DD or MM/DD/YYYY format.

Time in standby

It is possible to choose between the settings «Off», «On» and «On with night mode».

Clock design

The visual appearance of the clock on the standby screen can be changed. There are three clock faces from which to choose: «Digital», «Analogue» and «Dot».

Night mode

The night mode reduces the brightness of the time display. The start time for the night mode is settable.



The night mode always runs 8 hours.

Time synchronization

It is possible to choose between mains synchronization and real-time clock (RTC).

7.9 V-ZUG-Home

Mode

It is possible to choose between «Off», «Display» and «Operate and display». To connect the appliance to «V-ZUG-Home», «Display» or «Operate and display» must be selected.

Displaying information

Displays all relevant information for the connection.

Restarting interface

The interface can be reset if difficulties are experienced establishing a connection.

Resetting

Disconnects all connections to mobile devices.



Further information on V-ZUG-Home and its availability can be found at vzug.com.

7.10 Appliance information

Identification numbers

The serial number (SN) and article number are displayed.

Version numbers

The current software versions are displayed.

Descaling

The date of the last descaling process, the number of descaling processes already performed and the remaining operating time until the next necessary descaling process are provided (see page 58).

Demo mode

The appliance shows the current demo mode status. The demo mode can only be switched on and off in the service menu.

Contacting Customer Services

The contact information for our Customer Services is displayed.

7.11 Factory settings

Pinned values

Resets all pinned values.

Start screen

Resets the start screen to the app view. Favourites remain unchanged.

Favourites

Entering «OK» clears all existing favourites.

V-ZUG-Home

Disconnects all connections to mobile devices.

Factory settings

Resets the settings to the factory default state. All customized data will be lost.

7.12 EcoManagement

Consumption information

Displays the average energy consumption of the last 25 operations, the total energy consumption for the last month (or since a reset in the last month), the total energy consumption for the last year (or since a reset in the last year) and the total energy consumption.

Consumption indicator

If set to «On», the energy consumed is displayed when the application ends.

Resetting

Resets all EcoManagement counters except for total consumption.

7.13 Customer Services

This part of the menu is intended for service staff and is password-protected.

8 Care and maintenance



Risk of burns from hot surfaces!

Allow the appliance and the accessories to cool down before cleaning.

Incorrect handling can result in damage to the appliance!

Use soft cloths only. Do not use any abrasive, alkaline or highly acidic cleaning agents, metal scrapers that are sharp or scratch, steel wool, scouring pads, etc. as these products will damage the surfaces. Glass surfaces that are scratched can crack.

Never use a steam cleaner to clean the appliance.

8.1 Cleaning the exterior

- ▶ Remove any soiling or residues of cleaning solution immediately.
- ▶ Clean the surfaces and display with a soft cloth dampened with water and a little washing-up liquid.
- ▶ Dry with a soft cloth.

When cleaning the display, the  display lock can be used to protect the operating elements from being unintentionally activated.

8.2 Cleaning the cooking space



Incorrect handling can result in damage to the appliance!

Do not bend the temperature sensor.



The cleaning programme can be carried out with or without the special cleaner. The special cleaner is available as a special accessory.

- ▶ Any condensate or food particles must be completely removed after each cooking session with steam.
- ▶ Place the stainless steel tray under the perforated cooking tray or wire shelf when cooking to catch food particles and condensate.
- ▶ Clean the filter in the water outlet.



If the outlet is blocked in spite of this, contact Customer Services.

- ▶ Remove any soiling from the cooking space while still hand warm. Use a soft cloth dampened with water and a little washing-up liquid. Wipe dry with a soft cloth.
- ▶ Dried-on soiling can be removed more easily with the «Steam cleaning» application.
- ▶ For stubborn soiling, e.g. from chicken, use the cleaning programme «Intensive cleaning» or clean the cooking space when cold with a grease-dissolving spray cleaner or a non-abrasive cream cleaner in accordance with the manufacturer's instructions.



With use, the cooking space will over time turn a golden colour, which is normal for stainless steel. Neither the cooking or baking properties of the appliance nor its operation is affected.

Blue tarnish spots and condensate residue can generally be removed using a mild acidic cleaning agent or some lemon juice.



Over time with use, the cooking space can turn a shimmering rainbow colour or the surface can turn slightly matt. Neither the cooking or baking properties of the appliance nor its operation is affected.

These changes in colour can generally be removed using a non-abrasive cream cleaner.



For hygiene reasons, the appliance is automatically rinsed at the end of operation. These rinse cycles take 2–10 minutes, as required.

- The following appears in the display: «Appliance is rinsing.»



8.3 Intensive cleaning



The appliance must have cooled down before starting.

Remove accessories, cookware or other objects from the cooking space. Do not leave the appliance unattended: the cooking space needs to be wiped during cleaning.

How it functions

The cleaning programme  «Intensive cleaning» aids the removal of stubborn soiling in the cooking space. This application  requires the use of a cleaning agent.

The cleaning programme guides you step-by-step through the cleaning process.

SteamerCleaner





Not suitable for non-anodized aluminium surfaces or plastic surfaces. Wear protective gloves and protective goggles. Immediately rinse away any splashes with plenty of water.



«SteamerCleaner» was developed especially for this appliance.

- Dissolves fat and removes burned-on food debris efficiently
- Makes stainless steel shine
- The practical spray head reaches all surfaces of the cooking space, good adhesion
- Environmentally friendly, food friendly
- No unpleasant odours

- ▶ Long touch the display.
 - The start screen appears.
- ▶ Select the  «Cleaning» application group and confirm with «OK», if required.
- ▶ Select  «Intensive cleaning» and confirm with «OK».
 - The settings for «Intensive cleaning» appear in the display.
- ▶ Set a delayed start, if required (see page 20).
- ▶ Press «Start» to start «Intensive cleaning».

Removing the accessories and coarse soiling

- ▶ When the corresponding message appears in the display: Remove the accessories.



Remove the shelf guides and place them across the floor of the cooking space during the cleaning process (see page 57).

- ▶ Confirm the message with «OK».
 - Steam loosens up any baked-on soiling in the cooking space.

Spraying on the cleaner

- ▶ When the corresponding message appears in the display: spray on the cleaner.
- ▶ Confirm the message with «OK».
 - The cleaner starts to work.

Wiping down the cooking space

- ▶ When the corresponding message appears in the display: wipe down the cooking space.
- ▶ Confirm with «OK».
 - The cooking space is cleaned with steam. Excess cleaner is washed off.
- ▶ When the corresponding message appears in the display: wipe down the cooking space and open the appliance door as far as its airing position.
- ▶ Confirm with «OK».
 - The cooking space is dried.
 - The following appears in the display: «Process finished».

8.4 Steam cleaning



The appliance must have cooled down before starting.

Remove accessories, cookware or other objects from the cooking space. Do not leave the appliance unattended: the cooking space needs to be wiped during cleaning.

How it functions

The cleaning programme  «Steam cleaning» aids the removal of light soiling in the cooking space. The cleaning effect is achieved through steam.

The cleaning programme guides you step-by-step through the steam cleaning process.



Fill the water tank with fresh water and slot into position in the water tank compartment.

- ▶ Long touch the display.
 - The start screen appears.
- ▶ Select the «Cleaning» application group and confirm with «OK», if required.
- ▶ Select «Steam cleaning» and confirm with «OK».
 - The settings for «Steam cleaning» appear in the display.
- ▶ Set a delayed start, if required (see page 20).
- ▶ Press «Start» to start «Steam cleaning».

Removing the accessories and coarse soiling

- ▶ When the corresponding message appears in the display: Remove the accessories.



Remove the shelf guides and place them across the floor of the cooking space during the cleaning process (see page 57).

- ▶ Confirm the message with «OK».
 - The cooking space is cleaned with steam.

Wiping down the cooking space

- ▶ When the corresponding message appears in the display: wipe down the cooking space and open the appliance door as far as its airing position.
- ▶ Confirm the message with «OK».
 - The cooking space is dried.
 - The following appears in the display: «Process finished».

8.5 Cleaning the appliance door

- ▶ Clean the appliance door with a soft cloth dampened with water and a little washing-up liquid.
- ▶ Dry with a soft cloth.

Removing the appliance door



The appliance door is heavy. When removing and reinstalling the appliance door, hold it at the sides firmly with both hands.

- ▶ Open the appliance door as far as it will go.
- ▶ Fold the clips **2** on both door hinges **1** forward.

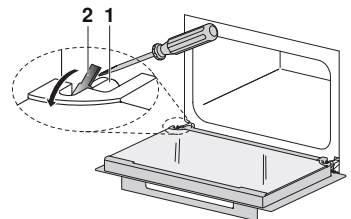

- ▶ Close the appliance door as far as its airing position (about 30°).
- ▶ Lift the appliance door out evenly and at an angle.

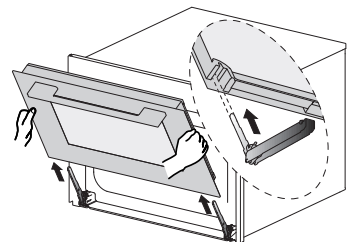

Reinstalling the appliance door

- ▶ Push the appliance door **3** evenly into both hinges **1** as far as it will go.
- ▶ Open the appliance door as far as it will go and fold back the clips **2**.
 - If the appliance door will not close properly, check the clips **2**.
 - Do not force the appliance door closed.

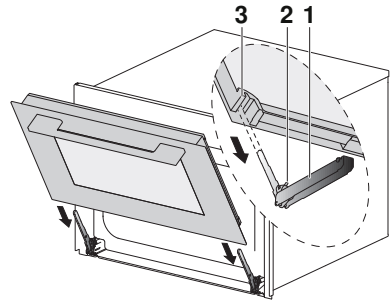

Ensure that the appliance door is pushed in as far as it will go otherwise the appliance could get damaged when it is closed.

Cleaning the door glass

- ▶ Lay the appliance door on a clean, flat surface (covered e.g. with a tea towel) with the handle facing down.
 - Make sure the handle does not come into contact with the surface.
- ▶ Lean against the appliance door.
- ▶ Gently push the outer glass **1** and raise it slightly up and away from the hinges.
- ▶ Remove the intermediate door glass seal **2**.
- ▶ Gently push the middle door glass **3** and raise it slightly up and away from the hinges.
- ▶ Clean the glass panels and dry well.

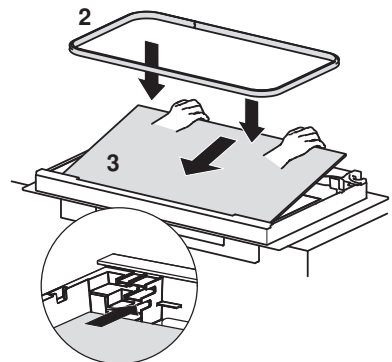
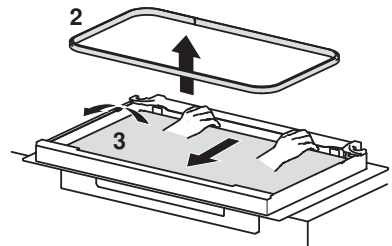
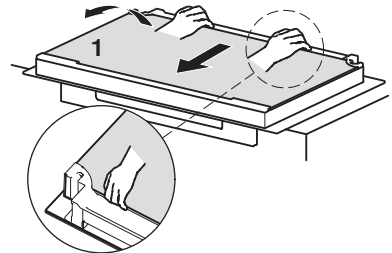

- ▶ Reassemble the glass panels as follows: Insert the middle door glass **3** into the door frame and gently push it back towards the hinges.
 - The markings on the glass must be legible.
- ▶ Reinstall the intermediate door glass seal **2**.

- ▶ Insert the outer door glass **1** into the door frame and gently push it back towards the hinges.
 - The outer door glass **1** can only be put back if positioned correctly with the shiny surface on the outside.

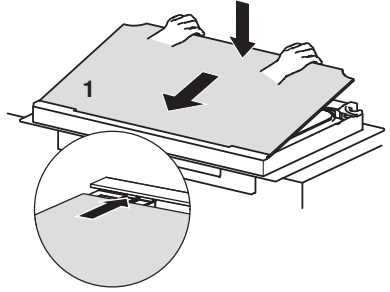

8.6 Cleaning the door seal

- ▶ Clean the door seal with a soft cloth dampened with water, but do not use any cleaning agent.
- ▶ Dry with a soft cloth.

8.7 Replacing the door seal



The door seal cannot be removed. For safety reasons, the door seal must be replaced by our Customer Services.

8.8 Replacing the LED light bulb



The LED light bulb cannot be removed. For safety reasons, the LED light bulb must be replaced by our Customer Services.

8.9 Cleaning the accessories and shelf guides



Incorrect handling can cause damage!

Do not clean the food probe in the dishwasher.

- ▶ Clean the food probe with a soft cloth dampened with water and a little washing-up liquid.
- The stainless steel tray, perforated cooking tray, wire shelf and shelf guides can be cleaned in the dishwasher.
- The baking tray can be cleaned in the dishwasher; however, this will affect its non-stick properties.

Removing the shelf guides

- ▶ Unscrew the knurled nuts **1** in the front of the shelf guides in an anti-clockwise direction.
- ▶ Pull the shelf guides **2** to the side of the screws and remove from the front.

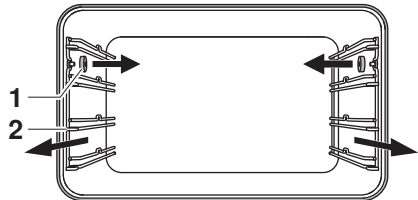

Reassembling the shelf guides

- ▶ Insert the shelf guides into the openings in the back wall of the cooking space and position on the screws. Place the knurled nuts on the screws and tighten securely in a clockwise direction.

8.10 Descaling

How it functions

Whenever steam is produced, depending on the hardness of the local water supply (i.e. the limescale content of the water), limescale is deposited in the boiler. The appliance automatically detects and indicates when descaling is necessary. The cleaning programme guides you step-by-step through the descaling process.



We recommend descaling the appliance whenever the message appears. Continued failure to descale the appliance will likely impair its functions or cause damage to the appliance. Descaling takes about 45 minutes.

Descaling interval

The time interval between descaling depends on the hardness of the water and frequency of use. If steaming 4× 30 minutes per week, the appliance must be descaled – depending on water hardness – roughly as follows:

Water hardness	Descal after about
Very hard	5 months
Hard	7 months
Medium	9 months
Soft	12 months

Calling up the remaining operating time

The approximate operating time remaining with steam until the next descaling can be called up in the user settings under «Descaling».

Descaler

durgol swiss steamer



Using the wrong descaler can damage the appliance!

Only use «durgol swiss steamer» to descale your appliance. The descaler contains highly effective acid. Immediately rinse away any splashes with water. Follow the manufacturer's instructions.



See «Accessories and spare parts» for where to obtain this descaler.



«durgol swiss steamer» was developed especially for this appliance.

Standard descaling solutions are not suitable as they may contain foam-creating additives or not be effective enough.

Using a different descaler could cause

- overfoaming inside the appliance
- insufficient descaling of the boiler
- damage to the appliance in the worst case.

Starting descaling



The appliance must have cooled down before descaling.

Remove accessories, cookware or other objects from the cooking space. Do not leave the appliance unattended: during the descaling process, the descaler must be added and the water tank must be emptied. The appliance door must be closed during descaling.

When the message «Do you want to descale the appliance now? You must accompany the process.» appears in the display:

- ▶ Touch «Yes».
 - The following appears in the display: «The appliance is being prepared for descaling.»



If an acoustic signal is emitted and «Residual heat too high» appears in the display, the appliance has not cooled down sufficiently and the descaling process cannot be started.

- ▶ Allow the appliance to cool down.
- ▶ When the corresponding message appears in the display: pour 0.5 l undiluted descaler into the water tank, insert the tank and confirm with «OK».
 - The descaling process starts.
 - The following appears in the display: «Descaling appliance.»



For safety reasons, once started the descaling process cannot be cancelled.

Discarding the rinsing solution

- ▶ When the corresponding message appears in the display: remove the water tank, pour the rinsing solution away and fill it with 1 l warm water.
- ▶ Put the water tank back.
 - The rinsing phase starts automatically.
 - The following appears in the display: «Rinsing appliance.»
- ▶ Repeat the procedure as often as required by the appliance.







As the water is heated up during final rinsing, the appliance door may steam up.

Ending the descaling process

- ▶ As soon as the corresponding message appears: remove, empty and dry the water tank.
- ▶ Confirm the message with «OK».
 - The following appears in the display: «Appliance was descaled successfully.»
- ▶ Confirm the message with «OK».
 - The appliance is ready for operation again.
- ▶ Wipe up any water in the bottom of the cooking space with a soft cloth.





After descaling, if the , ,  or  application is used the water that is pumped back into the water tank at the end of cooking may be cloudy. This will not affect the cooking or baking characteristics nor the quality of the food being cooked or baked.

9 Trouble-shooting

You may be able to trouble-shoot the following malfunctions yourself. If not, note down the error message in full (message, F and E numbers) and call Customer Services.

9.1 Error messages

Message	Possible cause	Solution
▪ «FX/EXX»	▪ Various situations can lead to an error message.	<ul style="list-style-type: none"> ▶ Acknowledge the error message by touching «OK». ▶ Switch the power supply off for about 1 minute. ▶ Switch the power supply back on. ▶ If the error appears again, note down the error message in full along with the serial number (SN) of the appliance (see page 64). ▶ Disconnect from the power supply. ▶ Contact Customer Services.
▪ «UX/EXX»	▪ Disruption in the power supply.	<ul style="list-style-type: none"> ▶ Acknowledge the error message by touching «OK». ▶ Switch the power supply off for about 1 minute. ▶ Switch the power supply back on. ▶ If the error appears again, note down the error message in full along with the serial number (SN) of the appliance (see page 64). ▶ Disconnect from the power supply. ▶ Contact Customer Services.
▪ «Descaling failed – Appliance was not descaled.»	<ul style="list-style-type: none"> ▪ Used unsuitable descaler. ▪ Descaling was not carried out correctly. 	<ul style="list-style-type: none"> ▶ Descalate again using the recommended descaler. ▶ If the message does not disappear after repeating the descaling process several times, note down the error message in full along with the serial number (SN) (see page 64). ▶ Contact Customer Services.
▪ «Check water feed»	▪ Appliance unable to draw water from the fixed water connection.	<ul style="list-style-type: none"> ▶ Check that the water inlet is open and water is available. ▶ If the water inlet is open, acknowledge the message by selecting ✓. <p>If the water inlet is open, yet the display does not remain in the acknowledged state:</p> <ul style="list-style-type: none"> ▶ Contact Customer Services.

Message	Possible cause	Solution
▪ «Appliance is rinsing»	▪ The water system is automatically rinsed about every 2 weeks.	No action needed.
▪ «E78/F24»	<ul style="list-style-type: none"> ▪ The appliance cannot pump the water off the bottom of the cooking space due to a pump malfunction or blockage. 	<ul style="list-style-type: none"> ▶ Note down the serial number (SN) of the appliance (see page 64) and contact Customer Services. ▶ Turn off the stopcock to the water supply.
	<ul style="list-style-type: none"> ▪ The appliance keeps trying to pump off water from the bottom of the cooking space even though there is none there. This is caused by a faulty level measurement. 	<ul style="list-style-type: none"> ▶ Start  at 100 °C for 10 minutes and allow the automatic steam reduction and rinse cycles to run through completely. ▶ The appliance can then be operated again as usual.
▪ «E79/F27»	<ul style="list-style-type: none"> ▪ The water system is not emptied due to a power failure during operation. 	<ul style="list-style-type: none"> ▶ About 2 minutes after the display has illuminated, acknowledge this by touching the  button. ▶ The appliance can then be operated again as usual.
	<ul style="list-style-type: none"> ▪ Valve is not tight. 	<ul style="list-style-type: none"> ▶ Shut off the water supply. ▶ Note down the serial number (SN) of the appliance (see page 64) and contact Customer Services.

9.2 Other possible problems

Problem	Possible cause	Solution
▪ Appliance is not working	<ul style="list-style-type: none"> ▪ A household fuse or circuit breaker has tripped. 	<ul style="list-style-type: none"> ▶ Change the fuse. ▶ Reset the circuit breaker.
	<ul style="list-style-type: none"> ▪ The fuse or circuit breaker keeps blowing. 	<ul style="list-style-type: none"> ▶ Contact Customer Services.
	<ul style="list-style-type: none"> ▪ Interruption in the power supply. 	<ul style="list-style-type: none"> ▶ Check the power supply.
	<ul style="list-style-type: none"> ▪ Demo mode is switched on. 	<p>The demo mode can only be switched off with the security code.</p> <ul style="list-style-type: none"> ▶ Contact Customer Services.
	<ul style="list-style-type: none"> ▪ Appliance is faulty. 	<ul style="list-style-type: none"> ▶ Contact Customer Services.
▪ Illumination is not working	<ul style="list-style-type: none"> ▪ LED light bulb is defective. 	<ul style="list-style-type: none"> ▶ Contact Customer Services.

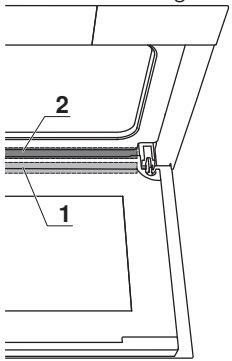
Problem	Possible cause	Solution
<ul style="list-style-type: none"> ▪ Cooking time seems longer than usual 	<ul style="list-style-type: none"> ▪ Appliance only has a one-phase connection. 	<ul style="list-style-type: none"> ▶ Connect appliance with a two-phase connection.
<ul style="list-style-type: none"> ▪ Steam is not visible during steam cycle 	<ul style="list-style-type: none"> ▪ The temperature of the cooking space is over 100 °C. 	<p>No solution required: steam over 100° C is not visible.</p>
<ul style="list-style-type: none"> ▪ Water in door-mounted condensate trough 	<ul style="list-style-type: none"> ▪ When using applications with steam, steam condenses on the appliance door and the water that results collects in the door-mounted condensate trough once the appliance door is opened. 	<p>The door-mounted condensate trough is used to collect condensed steam; residual water collecting here is normal.</p> <ul style="list-style-type: none"> ▶ Wipe up any residual water in the door-mounted condensate trough. Any residual water in the door-mounted condensate trough 1 will collect in the condensate trough 2 when the appliance door is closed. Wipe out the door-mounted condensate trough to prevent residual water from collecting in the condensate trough.
<ul style="list-style-type: none"> ▪ The control panel steams up 	<ul style="list-style-type: none"> ▪ Steam escaping during applications with steam. 	<p>Briefly steaming up is normal.</p> <ul style="list-style-type: none"> ▶ When closing the appliance door make sure that it forms a seal all the way round. ▶ If it continues to steam up heavily, contact Customer Services.
<ul style="list-style-type: none"> ▪ The appliance makes noises during operation 	<ul style="list-style-type: none"> ▪ Appliance can make noises at any time during operation (switching, pumping and fan noises). 	<p>Such noise is normal.</p>
<ul style="list-style-type: none"> ▪ Clock is not running correctly 	<ul style="list-style-type: none"> ▪ Irregular mains frequency. 	<ul style="list-style-type: none"> ▶ Turn off the mains synchronization. <p>Or:</p> <ul style="list-style-type: none"> ▶ Connect the appliance to the internet. <ul style="list-style-type: none"> – The time is automatically synchronized.
	<ul style="list-style-type: none"> ▪ Internal pulse generator is imprecise when mains synchronization is turned off. 	<ul style="list-style-type: none"> ▶ Contact Customer Services.

Problem	Possible cause	Solution
<ul style="list-style-type: none"> ▪ There is water in the bottom of the cooking space that cannot be pumped off 	<ul style="list-style-type: none"> ▪ Filter or outlet in the cooking space is clogged. 	<ul style="list-style-type: none"> ▶ Clean the filter. If the water still cannot be pumped off: ▶ Contact Customer Services.

9.3 After a power failure



The user settings remain unchanged.

Brief power failure during operation

- The current operation of the appliance is cancelled.
- The following appears in the display when the appliance is switched on: «Process was cancelled due to a power failure».
- ▶ Press «OK» to confirm the message.
 - The start screen appears.

Brief power failure during descaling

- The descaling process is interrupted.
- The following appears in the display when the appliance is switched on: «Power failure. Descaling is resumed.»
- ▶ Press «OK» to confirm the message.
 - The descaling process resumes.

Prolonged power failure





The appliance goes through its initial set-up process after a prolonged power failure. However, only the time and date need to be reset in order to operate the appliance again. It is not necessary to make any other settings.

- If a descaling process was running, the descaling process continues.

10 Accessories and spare parts

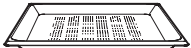
The accessories shown below as well as spare parts can be ordered in addition to the scope of delivery of the appliance. Ordering spare parts is subject to charge, except in the event of warranty claims. Please give the product family of the appliance and exact designation of the accessory or spare part when ordering parts.

10.1 Accessories

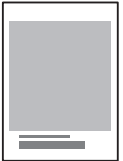
Stainless steel tray 	Perforated cooking tray 	Wire shelf 
Dual enamel baking tray 	Food probe 	Recipe book 

10.2 Special accessories

Information at: www.vzug.com

10.3 Spare parts

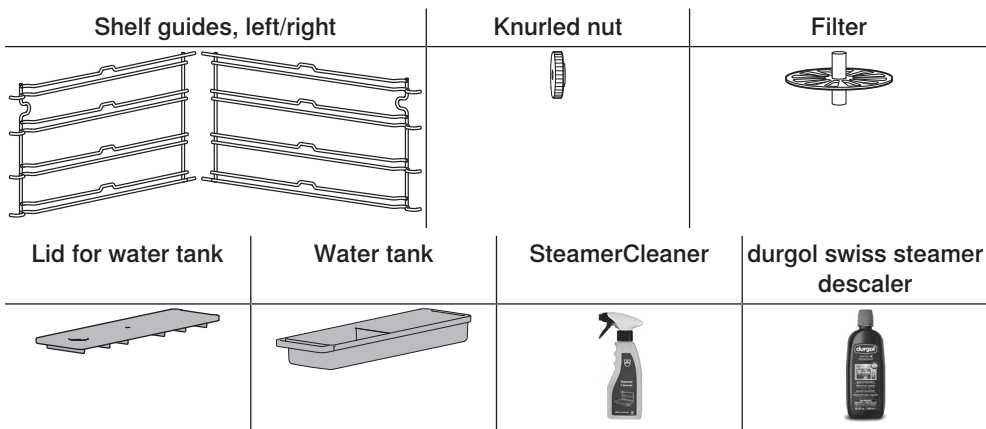

The descaler is also available from specialist retailers.

11 Technical data

External dimensions

- ▶ See installation instructions

Electrical connection

- ▶ See identification plate 1

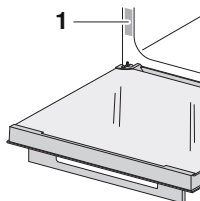

11.1 Light sources



Light sources may only be replaced by a service technician.

This product contains light sources of energy efficiency class E.



11.2 Note for testing institutes

Placing thermocouples between the appliance door and the seal can cause lack of leak-tightness and thus measuring errors.

The usable volume within the meaning of EN 50304 / EN 60350 is obtained with the shelf guides disassembled.

General note

Maximum load capacity: 3 kg

11.3 Temperature measurement

The temperature inside the cooking space is measured when the cooking space is empty according to an internationally accepted standard. Own measurements can be imprecise and are not suitable for checking the accuracy of the temperature.

11.4 Product fiche

In accordance with EU Regulation No.: 65/2014

Brand	-	V-ZUG
Type of appliance	-	Built-in steamer
Model designation	-	CS6TF
Energy efficiency class	-	A++
Energy consumption of conventional mode ¹⁾	kWh/cycle	-
Energy consumption of hot air / forced convection mode ²⁾	kWh/cycle	0.46
Energy Efficiency Index per cavity ³⁾	-	61.2
Number of cavities	-	1
Measurement and calculation methods used	-	EN 60350-1

¹⁾ Required to heat a standardized load per cavity

²⁾ Required to heat a standardized load per cavity

³⁾ Measurement methods: see EU Regulation No. 66/2014, Annex II, Chpt. 1

11.5 Product information

In accordance with EU Regulation No.: 66/2014

Model designation	-	CS6TF
Mass of appliance	kg	35
Heat source per cavity	-	Electricity
Volume per cavity	l	48

11.6 EcoStandby

To prevent unnecessary energy consumption, the appliance is equipped with the automatic energy-saving «EcoStandby» function.

In accordance with EU Regulation No. 2023/826

Off mode	W	-
Power consumption in standby mode	W	0.20
Standby mode with information or status display	W	0.80
Networked standby mode	W	1.50
Time required for the appliance to automatically reach the applicable low-power mode.	Mins	4

12 Tips and tricks

12.1 Unsatisfactory cooking result...

... for Soft roasting



Result	Solution
<ul style="list-style-type: none"> ▪ The meat is tough. 	<ul style="list-style-type: none"> ▶ Extend the cooking time. ▶ For very lean joints of meat, shorten the cooking time. ▶ Do not use meat that is too aged.

... for Professional baking

Result	Solution
<ul style="list-style-type: none"> ▪ Soft crust after baking. 	<ul style="list-style-type: none"> ▶ Extend the cooking time. ▶ Increase the baking temperature.

... for baking and roasting



Result	Solution
<ul style="list-style-type: none"> ▪ The baking or roast looks good on the outside but is still doughy or raw on the inside. 	<ul style="list-style-type: none"> ▶ Next time, set a lower temperature and lengthen the operating time.
<ul style="list-style-type: none"> ▪ The cake collapses. 	<ul style="list-style-type: none"> ▶ Check that the settings used correspond to those recommended in «EasyCook». ▶ Next time, set a lower temperature and lengthen the operating time. ▶ Stir the cake mixture well. When finished, bake immediately. ▶ For whisked sponges, beat the egg yolks/whites to a foam a little longer and then carefully fold into the mixture. When finished, bake immediately. ▶ Follow the instructions on how much baking powder to add.

Result	Solution
<ul style="list-style-type: none"> ▪ The baking has browned unevenly. 	<ul style="list-style-type: none"> ▶ Next time, set a lower temperature and adjust the operating time. ▶ If using ,  and , check that the levels used correspond to those recommended in «EasyCook». ▶ Do not push baking tins or bulky foodstuff right to the back of the cooking space.
<ul style="list-style-type: none"> ▪ The baking has come out lighter on one baking tray than on the other. 	<ul style="list-style-type: none"> ▶ Check that the settings used correspond to those recommended in «EasyCook».



Some uneven browning is normal. More even browning is generally achieved at lower temperatures.

... for regenerating food

Result	Solution
<ul style="list-style-type: none"> Regenerated food is dried out. 	<ul style="list-style-type: none"> Next time, set a lower temperature and shorten the operating time. Use  «RegenerateOmatic humid».
<ul style="list-style-type: none"> Too much condensate on or around the regenerated food. 	<ul style="list-style-type: none"> Next time, set a higher temperature and lengthen the operating time. Use  «RegenerateOmatic crispy».

12.2 General tips

- A variety of food can be cooked at the same time, e.g. rice or pulses together with vegetables that have similar cooking times, saving energy.
- Cook grains (e.g. rice and millet) and pulses (e.g. lentils), adding an appropriate amount of liquid, directly in suitable tableware.
- Put the tableware directly on the perforated cooking tray or wire shelf.

12.3 Saving energy

The  «Hot air humid» and especially the  «Hot air eco» applications consume less energy than the  «Hot air» application.

- Avoid opening the appliance door frequently.
- Only switch the illumination on when needed.
- Use residual heat: for cooking times over 30 minutes, switch the appliance off 5–10 minutes before the end of the operating time.
- Only preheat the cooking space if the cooking or baking results depend on it.
- Minimize preheating.



Power consumption can be reduced to a minimum by selecting «Hide time» in the user settings. Despite EcoStandby, the safety functions remain active.

13 Disposal

13.1 Packaging



Never allow children to play with packaging material due to the danger of injury or suffocation. Store the packaging material in a safe location or dispose of it in an environmentally-friendly way.

13.2 Safety

Render the appliance unusable to prevent accidents caused by improper use (e.g. through children playing):





- Disconnect the appliance from the mains. With a fixed appliance, this is to be carried out by a qualified electrician. Then cut the mains cable off flush with the appliance.

13.3 Disposal



- The «crossed out wheeled bin» symbol requires the separate collection of waste electrical and electronic equipment (WEEE). Such equipment can contain hazardous, environmentally harmful materials.
- These appliances are to be handed over to a designated collection point for the recycling of electrical and electronic equipment and must not be disposed of with unsorted household waste. And in this way, you will be helping to protect resources and the environment.
- For more information, please contact the local authorities.

Addresses of the importers

			
AU/NZ	V-ZUG Australia Pty. Ltd. 2/796 High Street Kew East, Victoria 3102, AUSTRALIA	LB	Kitchen Avenue SAL Mirna El Chalouhi Highway Wakim Bldg, Jdeihah Beirut LEBANON
CN	V-ZUG (Shanghai) Domestic Appliance Co. Ltd. Raffles City Changning Office Tower 3 No. 1193 Changning Road 200051 Shanghai CHINA	RU	OOO Hometek Dubinskaya Street 57 building 1 113054 Moscow RUSSIA
AT/BE/ DK/DE/ ES/FR/ NO/NL/ LU/SE	V-ZUG Europe BV Evolis 102 8530 Harelbeke BELGIUM	SG	V-ZUG Singapore Pte. Ltd. ION Orchard 2 Orchard Turn #02-07B Singapore 238801 SINGAPORE
GB/IE	V-ZUG UK Ltd. 27 Wigmore Street London W1U 1PN GREAT BRITAIN	TH	V-ZUG (Thailand) Ltd. 989 Siam Piwat Tower, 12 A Floor, TT25, Rama1 Road, Pathumwan Pathumwan, Bangkok 10330 THAILAND
HK/MO	V-ZUG Hong Kong Co. Ltd. 12/F, 8 Russell Street Causeway Bay HONG KONG	TR	GÜRELLER Anchor Sit.3A/1-2 Çayyolu 06690 ÇANKAYA/ANKARA TURKEY
IT	Frigo 2000 S.p.A Viale Fulvio Testi 125 20092 Cinisello Balsamo (Milano) ITALY	UA	Private enterprise "Stirion" (MIRS corp.) Osipova Street 37 65012 Odessa UKRAINE
IL	Digital Kitchen Hataarucha 3 6350903 Tel Aviv ISRAEL	VN	V-ZUG VIETNAM COMPANY LTD. 21st Floor, Saigon Centre, 67 Le Loi Ben Nghe Ward, District 1 Ho Chi Minh City, 700000 VIETNAM

14 Index

3-point food probe..... 14

A

Accessories 12, 63

Addresses of the importers 69

App

Moving 16

App view 10

Appliance

Disposal..... 68

Switching off 31

Switching on 15

Appliance description 10

Appliance door

Reinstalling..... 56

Removing 55

Appliance information

Contacting Customer Services 51

Demo mode..... 51

Descaling 51

Identification numbers 51

Version numbers..... 51

Appliance tips..... 31

Calling up..... 31

Application 17

Changing..... 18

Selecting..... 17

Starting..... 18

Application group

Selecting..... 17

Application tips..... 24

Hiding..... 24

Showing 24

Applications 32

Assistance functions 50

Automatic door closing 50

Automatic door opening..... 50

Illumination 50

Preheat tone 50

Water compartment flap..... 50

AutoDoor 14

Automatic door opening..... 23

B

BakeOmatic 41

Baking tray 12

C

Cancelling an application..... 28

Care and maintenance 52

CircleSlider

Reaction 18

Using..... 17

Cleaning

Accessories 57

Appliance door..... 55

Cooking space..... 53

Door glass 56

Door seal..... 57

Food probe..... 57

Shelf guides..... 57

Cleaning the exterior 52

Clock 28

Hiding..... 28

Hiding during operation..... 20

Showing 28

Showing during operation..... 19

Clock design..... 50

Construction..... 10

Cooking space

Temperature measurement 65

Cuisines from around the world..... 46

D

Date and time

Clock..... 50

Clock synchronization..... 51

Date..... 50

Date and time format 50

Night mode 51

Time in standby..... 50

Time synchronization 50

Degree of moisture..... 41

Delayed start..... 20

Setting 20

Descaling..... 58

durgol swiss steamer..... 58

Ending..... 59

Failed 60

How it functions 58

Interval 58

Rinsing phase 59

Starting 59

Desiccating 34

Dietary styles 46

Display

Background 48

Brightness 48

Colour scheme..... 48

Operating 15

Display lock 27

Turning off 27

Turning on..... 27

Disposal..... 67

Door seal		Switching on	27
Replacing	57	Individual settings	
E		EasyCook – cuisines from around the world	49
EasyCook	45	EasyCook – dietary style	49
Food groups	45	Start screen	49
EcoManagement		Subsequent steps.....	49
Consumption indicator	52	Temperature unit.....	49
Consumption information	52	Water hardness.....	49
Resetting	52	Intensive cleaning	53
EcoStandby.....	65	K	
Electrical connection	64	Keep warm.....	39
End	20	L	
End of operation	29	LED light bulb	
With AutoDoor.....	30	Replacing	57
Ending an application before time	29	Levels	12
External dimensions	64	List view	10
F		Load capacity	64
F and E messages	60	Long cooking time.....	62
Factory settings	52	M	
Favourites.....	52	Malfunctions.....	60
Pinned values	51	Model designation	2
Start screen.....	51	O	
V-ZUG-Home.....	52	Operating and display elements.....	10
Favourites.....	24	Operating time.....	19
Changing.....	24	Setting.....	19
Creating.....	24	Operation.....	15
Deleting	25	Options	21
Starting.....	25	Selecting.....	22
Food probe	20, 63	Starting	22
Food probe temperature	20	Other possible problems.....	61
Measuring only.....	21	Own recipes.....	43
Setting.....	21	Changing.....	44
Function bar.....	10	Copying	45
Function buttons	10	Copying a recipe	45
Expanding	16	Creating	44
G		Deleting	45
General tips.....	67	P	
H		Perforated cooking tray	13
Hot air	32	Pinning	25
Hot air eco	33	Main value.....	25
Hot air humid.....	32	Resetting a main value.....	26
Hot air with steaming	32	Power failure	63
Hot massage stones	40	Power interruption.....	63
Hot wraps	40	Preheating	22
Hygiene	40	Turning on.....	23
Hygiene baby bottles	40	Preserve jam.....	41
Hygiene preserving jars.....	41	Problems	60
I		Product fiche.....	65
Identification plate.....	64, 75	Product information	65
Illumination	27, 61	Professional baking.....	36, 66
Switching off	27		71

Classical	36	Socket.....	12
Flour-dusted.....	36	Soft roasting.....	37, 66
Glazed.....	36	Cancelling or switching off before time...	39
Proofing	36	How it functions	37
Selecting and starting	36	Seared	38
		Selecting and starting	38
Q		Soft roasting table	37
Quick information		Spare parts	63, 64
Displaying.....	16	Special accessories	14, 64
Quick instructions	76	Stainless steel tray.....	13
Quiet mode	28	Start later	23
Turning off	28	Setting	23
Turning on	28	Starting	23
R		Start screen.....	16
Ready to start	11	Steam cleaning	54
Recipe		Steam reduction.....	27
Action required.....	43	Carrying out	27
Cancelling	43	SteamerCleaner	53
Starting.....	42	Steaming	33
Recipe book	42, 63	Subsequent steps.....	30
Recipes.....	42	Cancelling operation.....	31
Refreshing towels	40	Continuing operation.....	30
RegenerateOmatic.....	41	Symbols.....	5
Regeneration	34, 67		
Regeneration time	42	T	
S		Target temperature	21
Safety precautions		Technical data	64
Appliance-specific	5	Technical questions.....	75
Before using for the first time.....	6	Temperature sensor.....	12
Burns hazard	7	Testing institutes	64
Correct use	7	Timer	26
General.....	5	Changing.....	26
How to avoid damaging the appliance		Checking	26
.....	8	Setting	26
Instructions for use.....	6	Starting	26
Note on use	7	Switching off before time	27
Risk of injury.....	8	Tips and tricks.....	66
Risk to life	8	Type.....	2
Saving energy.....	67	U	
Seed cushions.....	40	U and E messages.....	60
Service & Support.....	75	Uneven browning.....	66
Setting options.....	11	Unsatisfactory cooking results	66
Setting range	19	User settings.....	48
Settings		Adjusting	48
Changing.....	22	Appliance information	51
Checking	22	Childproof lock.....	48
Shelf guides		Customer Services	52
Reassembling.....	57	Date and time.....	50
Removing.....	57	Display	48
Signals and tones		EcoManagement.....	52
Acoustic signals.....	49	Factory settings.....	51
Feedback tones	49	Individual settings.....	49
Quiet mode	48	Language	48
Sound worlds	49	Signals and tones.....	48
		V-ZUG-Home	51

Using for the first time..... 9

V

Vacuisine 34

 Selecting and starting 35

Validity..... 2

Values

 Adjusting..... 18

 Saving 18

V-ZUG App..... 47

V-ZUG-Home..... 47

 Displaying information 51

 Mode 51

 Resetting 51

 Restarting interface 51

W

Warming plates in the cooking space 39

Warranty extensions 75

Water tank 14

 Filling 17

Wellness 40

Wire shelf 14

WLAN connection 47

15 Notes

16 Service & Support



The «Trouble-shooting» section gives you valuable tips on how to deal with minor malfunctions yourself, saving you the time and trouble of calling out a service technician and any cost that goes along with it.

Information on the V-ZUG warranty can be found at www.vzug.com →Service →Warranty information. Please read this information carefully.

Please register your appliance straightaway online at www.vzug.com →Service →Warranty registration. This will allow you to take advantage of the best possible support in the event of a fault in the appliance during the guarantee period. You will require the serial number (SN) and appliance designation to register your appliance. You will find them on the identification plate of your appliance.

My appliance information:

SN: _____ **Appliance:** _____

Please have this appliance information to hand when contacting V-ZUG. Thank you.

Identification plate

- ▶ Open the appliance door.
 - The identification plate is located on the left-side panel.

Your repair order

At www.vzug.com →Service →Service number you will find the telephone number of your nearest V-ZUG service centre.

Technical questions, accessories, warranty extensions

V-ZUG is happy to help you with any general administrative or technical queries, to take your orders for accessories and spare parts and to inform you about our progressive service agreements.

Quick instructions

On/Off

Touch the display to switch the appliance on. Long press and hold the  function button to switch the appliance off.

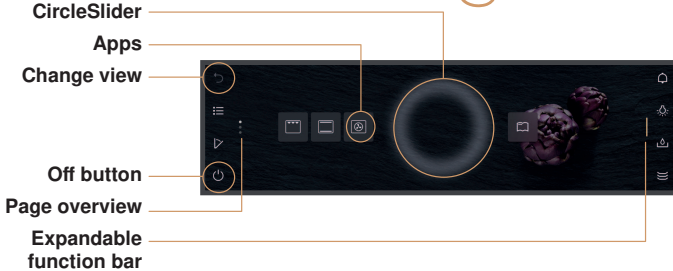

Quick information

Move app

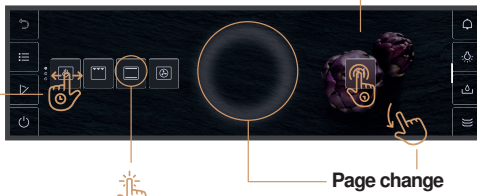

Operation

The appliance is operated using the display. Place your finger on the CircleSlider and move it in a circle.

Adjustable value

Favourite

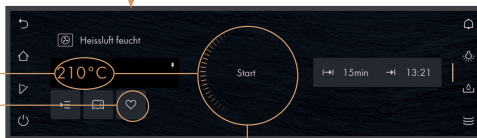

Temperature

The temperature can be set using the CircleSlider.



1094278-09

