

omega

OPERATING AND INSTALLATION INSTRUCTIONS
FOR

00653X

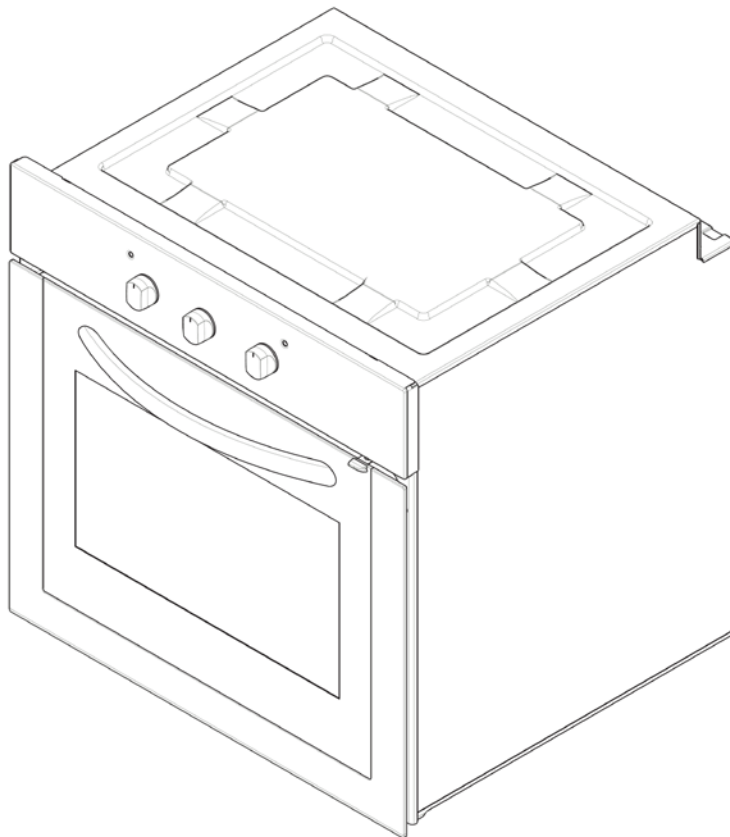

INSTALLATION, OPERATION AND MAINTENANCE INSTRUCTIONS FOR OMEGA BUILT-IN ELECTRIC OVEN RANGE

OO653X BUILT-IN ELECTRIC OVEN

CONGRATULATIONS

Thank you for choosing one of our many fantastic built in ovens. We are confident that you will now be able to meet your cooking needs. Before you use the oven we strongly recommend that you read though the whole user manual which provides the description of this product and the proper use of its functions.

To avoid the ever-present risks involved with using an electrical appliance it is vital that the oven is installed correctly and that you read the safety instructions carefully to avoid misuse and hazards. It is important that you retain these instructions and your proof of purchase along with any other important documents about this product for future reference.

CONTENTS

SECTION	PAGE NO.
Important Safety Instructions.....	3
Appliance Details.....	4
Electrical Connections.....	4-5
Installation.....	6-7
Operating Instructions.....	8-14
Cleaning.....	15
Troubleshooting.....	15
Transportation.....	16
Recommended Cooking Times.....	17
Cooking Guides.....	18-19

DISPOSAL INFORMATION

- Most of the packing materials are recyclable. Please dispose of those materials through your local recycling depot or by placing them in appropriate collection containers.
- If you wish to discard this product, please contact your local authorities and ask for the correct method of disposal.

IMPORTANT SAFETY INSTRUCTIONS

IMPORTANT: Read the assembly instruction section and safety precautions of this booklet carefully before removing the contents of this carton.

1. This appliance is not intended for use by persons (including children) with reduced physical, sensory or mental capabilities, or lack of experience or knowledge, unless they have been given supervision or instructions concerning the use of the appliance by a person responsible for their safety. Children should be supervised to insure that they do not play with the appliance.
2. In certain circumstances electrical appliances may be a danger hazard.
3. Do not place heavy objects in or on these appliances, use for storage or let children play/swing from the door. These appliances are designed for cooking food only.
4. This appliance is designed for domestic household use only and for the cooking of domestic food products. Use as a commercial appliance will void the warranty. It should not be used in a marine environment or outdoors.
5. This appliance is supplied with a 15 amp plug. The plug has a large earth terminal that will not fit into a common electrical socket. To install the oven, a special socket is required to be installed by a licensed electrician (if it does not already exist at the point of installation).
6. If the electrical supply cord is damaged, either when being installed or after installation, it must be replaced by the manufacturer, its service centre or similarly a qualified persons in order to prevent a hazard.
7. The electrical connection must be accessible after installation. The appliance must be electrically isolated before any maintenance can be performed, which includes changing a lamp.
8. Electrical connection must be made as per local wiring rules and regulations. Do not disconnect the appliance with wet hands or bare feet, and do not disconnect the power cord with extreme force.
9. Always grasp the oven door in the centre of the handle as the areas around the door edges may be hot due to the escape of hot air.
10. Ensure that the kitchen is well ventilated or mechanical ventilation is in use while cooking with this appliance.
11. Do not store or use flammable materials or aerosols near the oven. Items made from aluminium, plastic or plastic film should also be kept away from the appliance, as they may fuse to the surface.
12. Never line the oven bottom with aluminium foil, as the consequent accumulation of heat could compromise the cooking and even damage the enamel.
13. **WARNING** - The oven will become hot during and directly after use. Do not touch any components during this time, as they may be hot and can cause burns. Do not touch the heating elements inside the oven to avoid burns. Children should be kept away. Use heat resistant cooking gloves where possible when moving food and cooking utensils in and out of the oven.
14. Cleaning may only be commenced on the appliance once it has cooled down (best slightly warm). The appliance should be disconnected from the power outlet or turned off at your isolation switch before commencing any cleaning process. Do not use a steam jet or any other high pressure cleaning equipment to clean the appliance. Follow oven cleaner directions if these are being used.
15. Wash all accessories in hot soapy water or in a dishwasher, wipe dry with a paper or cloth towel. If you use your oven for an extended period of time, condensation may form. Dry it using a soft dry cloth.
16. When the appliance is not being used, the knobs must be kept in the 'OFF' position.
17. Where this appliance is installed in a caravan, it shall NOT be used as a space heater.
18. Do not modify this appliance.
19. Do not use harsh abrasive cleaners or sharp metal scrapers to clean the glass oven door as it can scratch the surface, which may result in the glass shattering. Clean the glass door using warm damp cloth and dry it with a soft cloth.
20. All cabinetry and materials used in the installation must be able to withstand a minimum temperature of 50°C above the ambient temperature of the room it is located in, whilst in use. Certain types of vinyl or laminate kitchen furniture are particularly prone to heat damage or discolouration at temperatures outside the guidelines given above. Any damage caused by the appliance being installed without adhering to the temperature limits set out above will be the liability of the owner.
21. This appliance must be correctly installed by a suitably qualified person, strictly in accordance with the manufacturer's instructions. Please see the specific section of this booklet that refers to installation.
22. The appliance must be installed and put in operation by an authorised technician under the conditions provided by the manufacturer in this manual. The manufacturer cannot be held responsible for any damage that might occur due to faulty installation.
23. The values indicated on the printed documents found on the product are values obtained in laboratory environment according to relevant standards. These values may vary according to the usage and environment conditions of product.
24. This operating manual has been prepared jointly for multiple models. Some of the specifications explained in the manual, may not be included in your appliance. Pay attention to the explanations with illustrations while reading the manual.

APPLIANCE DETAILS

ELECTRICAL DETAILS:

OVENS: OO653X

Rated Voltage: 220 to 230V ac 50 Hz

Max Rated Inputs: 2600W

Supply Connection: OVENS - 15 A plug

This information can be found on the rating plate (data label) affixed to the inside of the door jamb.

SIZES:

Relevant Sizes:	LENGTH (mm)	WIDTH (mm)	HEIGHT (mm)
External Oven size	595	570	595

ELECTRICAL CONNECTIONS



LOCAL AUTHORITY REQUIREMENTS

Installation is only permitted by a licensed electrician, and carried out according to instructions provided by the manufacturer. Incorrect installation might cause harm and damage which the manufacturer accepts no responsibility.

ELECTRICAL INSTALLATION FOR THE LICENSED ELECTRICIAN

This oven must be connected to a 220-240V 50Hz power supply. It is earthed via the cord and 15A plug.

Before carrying out the connection to the power supply, the voltage rating of the appliance (stamped on the appliance identification plate) must be checked for correspondence to the available mains supply voltage, and the mains electric wiring should be suitable for the oven's power rating (also indicated on the appliance identification plate);

The switched outlet must be connected to a suitable earth wiring, in conformity to current safety regulations.

This appliance must be plugged into a 15A switched outlet. It should not be located above the appliance and no more than 1.25m away from it. The power supply cord must not touch any hot surfaces and must be placed so that its temperature does not exceed 75°C at any point along its length.

After having installed the appliance, the switched outlet must always be in an accessible position.

NOTE: For connections to the mains power supply, never use adapters, reductions or multiple power points as these may overheat and catch fire.

The mains terminal block is located on the back of the oven and the terminals are accessible by opening the terminal block cover. Note: The terminal cover should not be opened when the mains power is still connected to the appliance and never by an unauthorized person.

The electrical safety of this appliance can only be guaranteed if the oven is correctly and efficiently earthed. The manufacturer declines all responsibility for damage resulting from an installation which has not been earthed correctly. The use of adapters, multiple sockets and/or extensions, is not allowed.

OVEN LAMP REPLACEMENT

- The appliance must first be disconnected from the power outlet or turned off at your isolation switch.
- Unscrew the glass cover attached to the lamp holder; anti-clockwise.
- Unscrew the lamp and replace it with another high-temperature lamp with the following characteristics:

Type: E 14

Voltage: AC220V-240V

Wattage: 25W Temperature rating: 300°

- Remount the glass cover and reconnect the appliance to the power supply

NOTE: Should you experience any difficulty please contact your nearest after-sales service centre.

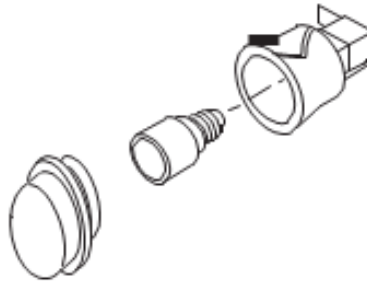

INSTALLATION



The adjacent furniture must be able to withstand a minimum temperature rise of 50°C above the ambient temperature of the room it is located in during periods of use. The power supply to the appliance must be cut off before any adjustments or maintenance work is done on it.

PREPARATION FOR INSTALLATION AND USE

Manufactured with best quality parts and materials, this modern, functional and practical oven will meet your needs in all respects. Make sure to read the manual to obtain successful results so as not to experience any problems in the future. The information given below contains rules that are necessary for correct positioning and service operations. They should be read without fail, especially by the technician who will position the appliance.

CHOOSING A PLACE FOR THE APPLIANCES

There are several factors to consider when choosing a place for your oven. Make sure to take into account our recommendations below in order to prevent any problems and dangerous situations, which might arise.

When choosing a place for the oven, attention should be paid to ensure there are no flammable or combustible materials in the close vicinity, such as curtains, oil, cloth etc. which quickly catch fire. Furniture surrounding the oven or cooktop must be made of materials resistant to temperatures above 50 C°. Required changes to wall cabinets and exhaust fans above a built-in cooktop as well as minimum heights from the oven board are shown in Figure 1. Accordingly, the exhaust fan should be at a minimum height of 65 cm from the cooktop. If there is no exhaust fan the height should not be less than 70 cm.

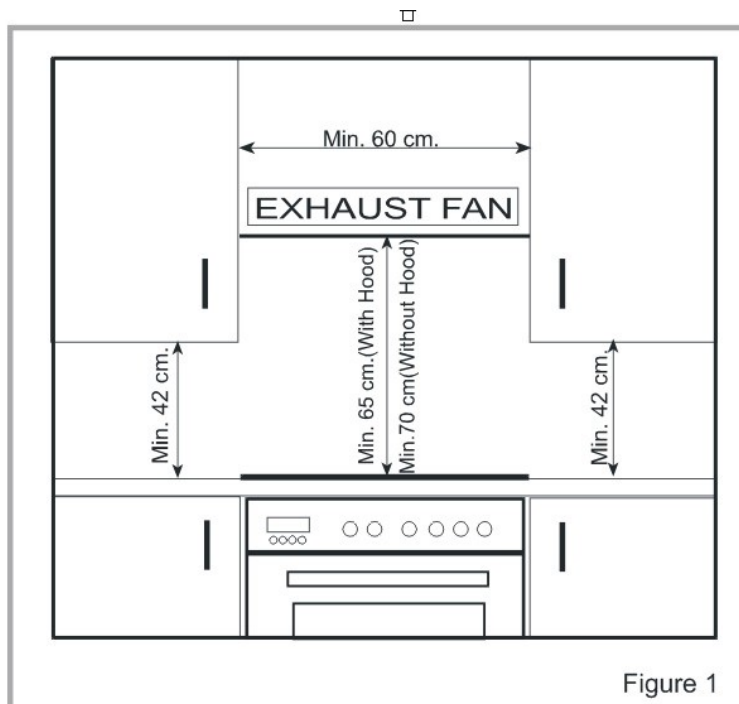

INSTALLATION OF BUILT IN OVEN

Insert the oven into cabinet partly by pushing it forward. Open the oven door and insert 2 screws into the holes on the oven frame. While the product frame touches the wooden surface of the cabinet, tighten the screws. The dimensions and material of the cabinet in which the oven will be installed must be correct and resistant to increases in temperature. In a correct installation, contact with electrical or insulated parts must be prevented. Insulating parts need to be fitted in a way to ensure that they cannot be removed by using any kind of tool. Installing the appliance in the close vicinity of a refrigerator or a deep-freezer is not recommended as the performance of the above-mentioned appliances will be negatively affected due to emanating heat. After removing your oven from its packaging, be sure that the oven is not harmed. In the case you suspect any damage to the appliance, do not use it; immediately contact an authorized Service Centre.

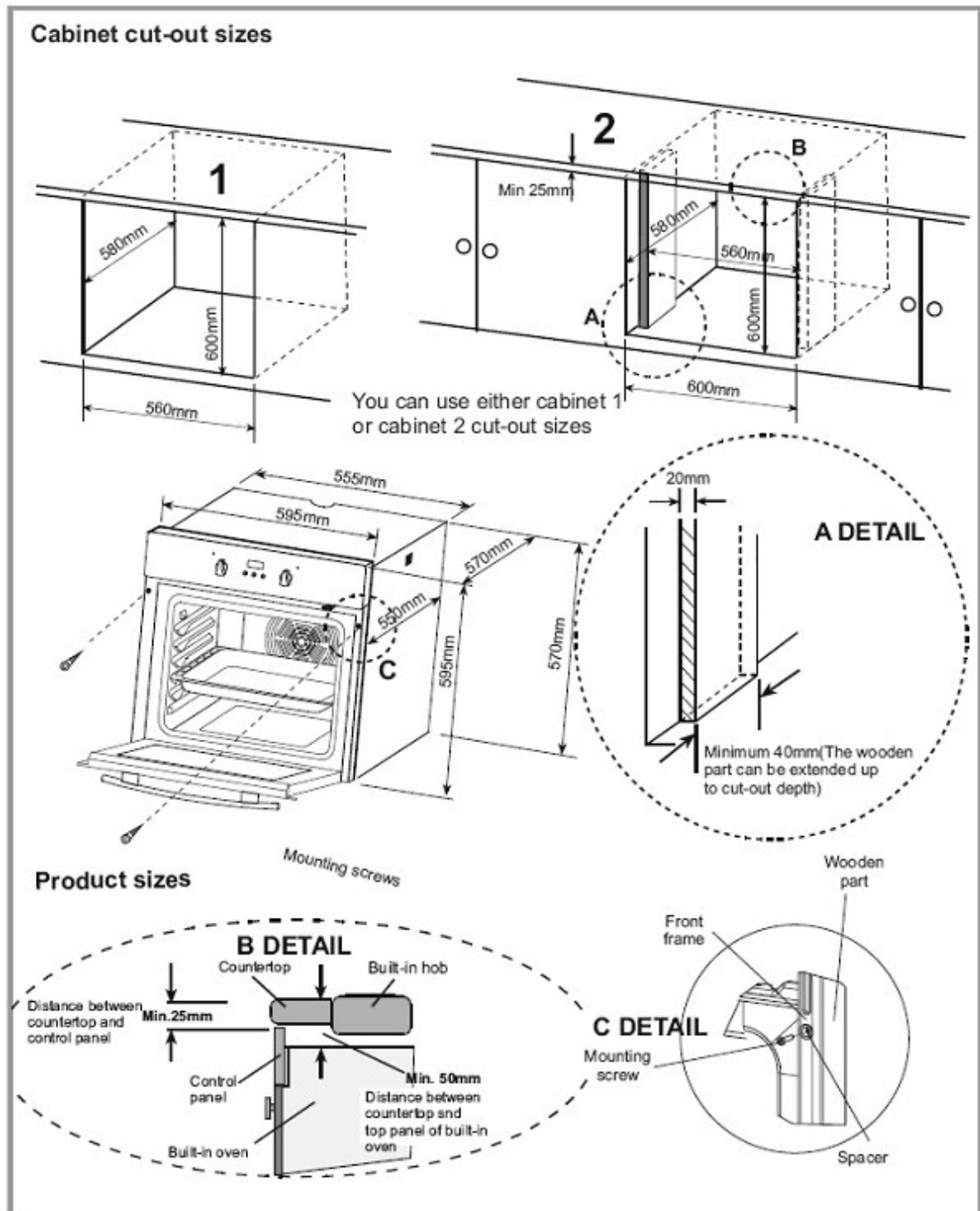

OPERATING INSTRUCTIONS

FRONT VIEW:

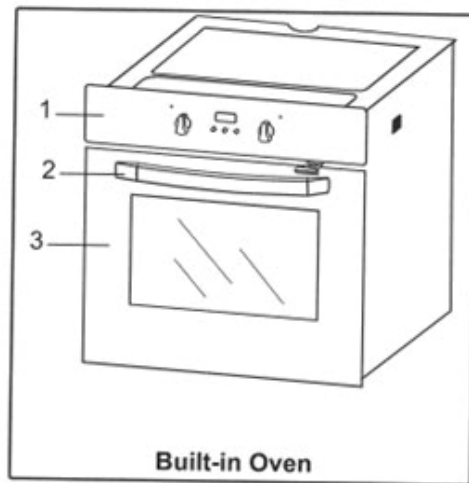

INTERNAL VIEWS:

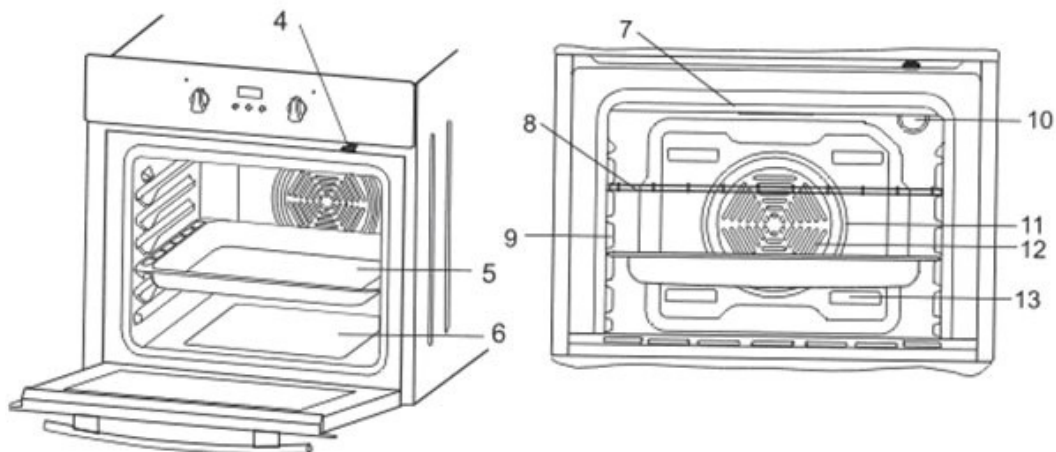

1. Control Panel.
2. Handle.
3. Oven Door.
4. Child Lock (not available on these models).
5. Tray.
6. Bottom Heating Element.
7. Top Heating Element.
8. Wire Grill.
9. Racks/Shelf Holders.
10. Oven Light.
11. Turbo Heating Element.
12. Fan.
13. Air Outlet Shutters.

When you first run your oven a certain smell will be emanated arising from the insulation materials and the heater elements. For this reason, before using your oven, run it empty at maximum temperature for 45 minutes. At the same time you need to properly ventilate the environment in which the oven is installed.

In order to cook in your oven, the oven function and temperature setting controls need to be adjusted and the oven timer, if available, needs to be programmed. Otherwise, the oven will not operate.

Unplug your appliance when it is not in use.

Protect your appliance from atmospheric effects. Do not leave it under the effects of the sun, rain, snow, dust etc.

CONTROLS

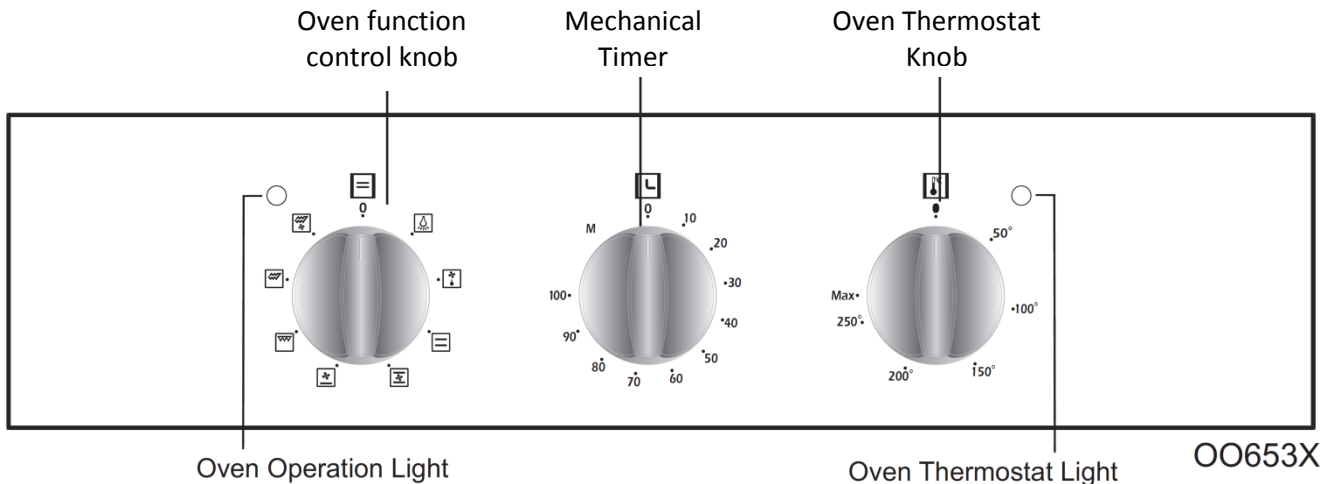

OVEN FUNCTION/WARNING LIGHT CONTROL

The oven function/warning light control button is used to select the different functions (an example is figure 11). Each is explained in detail. To select a function, turn the control knob to the desired oven function and then set the temperature with the thermostat control.





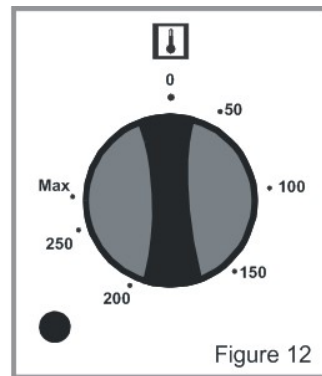
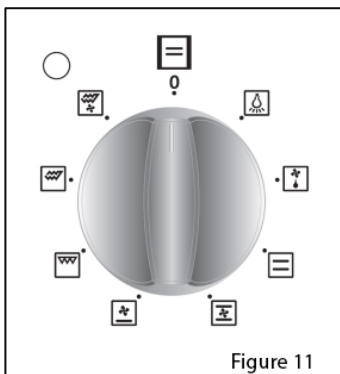



OVEN THERMOSTAT CONTROL

The oven thermostat control is used to select the desired temperature for cooking. When the temperature inside your oven reaches the value set, the thermostat will cut the circuit and the thermostat light will go off. When the temperature falls below the set value, the thermostat will again be turned on alongside the thermostat light. It is normal for this to occur during the cooking process, particularly when the door has been opened.



OVEN FUNCTION CONTROL CHART

The oven's mechanical timer must be on and in use or the control knob set to manual for the oven to work.

	LIGHT ONLY THE INTERNAL OVEN LIGHT WILL SWITCH ON.
	CONVENTIONAL THE LOWER AND UPPER HEATING ELEMENTS WILL SWITCH ON, ALONG WITH THE OVEN'S THERMOSTAT.
	FAN ASSIST THE FAN AND THE LOWER AND UPPER HEATING ELEMENTS WILL SWITCH ON, ALONG WITH THE OVEN'S THERMOSTAT.
	FAN ASSIST WITH LOWER HEAT THE FAN PLUS THE LOWER HEATING ELEMENT WILL SWITCH ON, ALONG WITH THE OVEN'S THERMOSTAT.
	MID-GRILL THE MID-GRILL ELEMENT WILL BE SWITCHED ON, ALONG WITH OVEN'S THERMOSTAT.
	MAXI-GRILL THE MID-GRILL AND UPPER HEATING ELEMENT WILL BE SWITCHED ON, ALONG WITH THE OVEN'S THERMOSTAT.
	MAXI-GRILL WITH FAN THE MID-GRILL ELEMENT, AND THE UPPER HEATING ELEMENT, PLUS THE FAN AND WILL BE SWITCHED ON, ALONG WITH THE OVEN'S THERMOSTAT.
	DEFROST THE FAN WILL SWITCH ON ALONG WITH THE OVEN LIGHTS TO PERFORM THE DEFROST FUNCTION.

Note: Oven shelves are numbered from 5 at the top down to 1 at the bottom when referring to the food cooking chart.

During heated oven functions a cooling fan in the top of the oven will operate in order to cool down the oven door and kitchen cabinet as well as reducing condensation in the oven. There will then be a slight release of warm air from the top of the closed oven door. This is not a leak in heat from the oven cavity.

OVEN FUNCTION CONTROLS



Defrost Function:

You can start the defrost operation by putting the frozen food into oven and bringing the function control knob to the indicated mark. This function will not cook/bake the food; it only helps to defrost it within a short time.

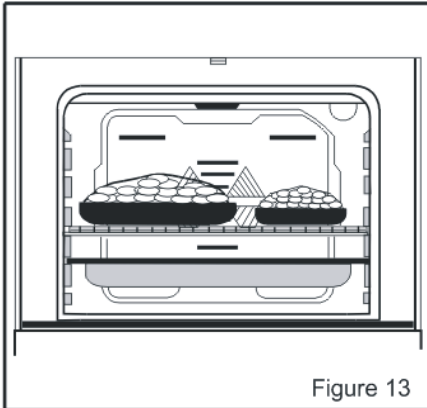

Figure 13

Put the food to be defrosted on the wire rack that you will place on the third rack support from the bottom (Figure 13). To collect the water that accumulates due to the melting ice, insert an oven tray onto a lower rack. This function is perfect for finishing off the defrosting process for frozen food that has been in the refrigerator from the evening before and may not be completely thawed out.



Conventional Cooking Function

This Conventional function allows heat to radiate evenly from the lower and upper elements into the oven ensuring even cooking of both sides of the food. Adjust the function control so it indicates the Conventional Cooking function symbol. Adjust the thermostat control knob of your oven to a temperature recommended on the cooking table for the cooking operation you wish to perform. Preheating of the oven for about 10 minutes is recommended. Place food in a suitable container, then place into oven and cook for the recommended time. This function is preferred for making cakes (cupcakes, other cakes and sponges), biscuits, pastry, baked pasta (e.g. lasagna), casseroles and moist dishes, roasts and oven chips.

After cooking, turn off the oven function and temperature control knobs and cancel the timer program if in use. Take the cooked food out of the oven and place it on a safe heatproof surface. As the oven will be hot, work near with caution and keep children away from the cooling oven.



Fan Assist Function:

This is the function where the air coming from the lower and upper heating elements is circulated into the oven by the fan motor and blade

Adjust the function control knob so it indicates the Fan Assist Function symbol and adjust the oven timer to the recommended time for cooking. Adjust the thermostat control knob to the temperature required on the cooking table for the Fan Assist Function and preheat oven for 10 minutes. Based on the convection function, this combination of features increases the effectiveness of the thermal radiation of the heating elements through forced air circulation of the heat throughout the oven. This helps prevent food from burning on the surface, allowing the heat to penetrate into the food. Food baked on this function such as pastry often brown faster than on conventional function alone.

After cooking, turn off the oven function and temperature control knobs and cancel the timer program if in use. Take the cooked food out of the oven and place it in a safe heatproof surface. As the oven will be hot, work near with caution and keep children away from the cooling oven.



Mid-Grill Function:

This function is used for grilling. Adjust the function control knob so it indicates the Mid-Grill function symbol and adjust the oven timer to the recommended time for cooking. Set the oven's thermostat control knob to the required temperature. After a preheating period of 10 minutes, put your food into the oven. For grilling, put the food on the grill rack and sit into the tray. Place the tray on the highest shelf (5). Placing the rack within the oven tray provided will ensure that any marinade, fat or oil dropping from the food will be collected. When grilling, the oven door must be closed. On this function, the middle heating elements/coils of the grill operate.

This setting is ideal for toasting bread, cheese melts and melting cheese topped dishes or finishing off a dish to lightly brown on the surface. Also used for herb and garlic bread.

After cooking, turn off the oven function and temperature control knobs and cancel the timer program if in use. Take the cooked food out of the oven and place it in a safe heatproof surface. As the oven will be hot, work near with caution and keep children away from the cooling oven.



Maxi-Grill Function:

This function is used for faster grilling and for grills with a lot of food. Adjust the function control knob so it indicates the Maxi-Grill function symbol. Set the oven's thermostat control knob to the required temperature. After a preheating period of 10 minutes, put your food into the oven. For grilling, put the food on the grill rack and sit into the tray. Place the tray on the highest shelf (5). Placing the rack within the oven tray provided will ensure that any marinade, fat or oil dropping from the food will be collected. When grilling, the oven door must be closed. On this function, all of the heating elements/coils of the grill operate.

The higher grill temperature and function is ideal for cooking and browning meat (such as lamb or pork chops and cutlets), chicken and seafood (such as fish fillets, cutlets, tuna steaks or Atlantic salmon). This setting is also good for browning fruit crumbles or crumb topped dishes.

After cooking, turn off the oven function and temperature control knobs and cancel the timer program if in use. Take the cooked food out of the oven and place it in a safe heatproof surface. As the oven will be hot, work near with caution and keep children away from the cooling oven.



Maxi-Grill with Fan Function:

This function will ensure complete, fast and all over grilling by working, the fan, the grill and the upper heating element at the same time. Adjust the function control knob so it indicates the Maxi-Grill with Fan function symbol and adjust the oven timer to the recommended time for cooking. Set the oven's thermostat control to the required temperature. After a preheating period of 10 minutes, put your food into the oven. For grilling, put the food on the grill rack and sit into the tray. Place the tray on the highest shelf (5). Placing the rack within the oven tray provided will ensure that any marinade, fat or oil dropping from the food will be collected. When grilling, the oven door must be closed.

The Maxi-grill with fan function is ideal for cooking food to achieve a crispy skin (such as chicken thigh or breast with the skin on) and lightly browning meat such as lamb and seafood.

After cooking, turn off the oven function and temperature control knobs and cancel the timer program if in use. Take the cooked food out of the oven and place it in a safe heatproof surface. As the oven will be hot, work near with caution and keep children away from the cooling oven.



Fan Assist with Lower Heat Function

This Fan Assist with Lower Heat function functions similarly to the Fan Forced with Lower Heat Function. It is different due to the absence of the turbo heater located in the back of the oven. This function will cook food in a slower more delicate process than the Fan Forced equivalent and is recommended for finishing off the cooking of food (in baking dishes or trays) which is already superficially well-cooked and golden on the top but still soft inside. This is an ideal function for delicate cooking such as quiches, cheesecakes and custards where limited top browning of the food is required.

After cooking, turn off the oven function and temperature control knobs and cancel the timer program if in use. Take the cooked food out of the oven and place it in a safe heatproof surface. As the oven will be hot, work near with caution and keep children away from the cooling oven.

ENERGY SAVING

Choose cookware of an appropriate size. Using a lid will reduce cooking times. Minimize the amount of liquid or fat to reduce cooking times. Oven door should not be opened often during cooking period.

USING THE MECHANICAL TIMER

To set a time, rotate the timer control knob clockwise to a certain time range between 0 - 100 minutes, as shown on the picture (Figure 16). The oven will stop when the set time range is completed, and the timer will give an audible warning once.

This is referred to as Manual use or Manual operation, when you want total control of the cooking functions and cooking time.

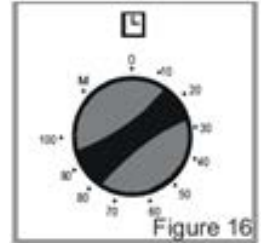

ACCESSORIES

It is recommended that you use the containers indicated depending on the food you will cook in your oven. You can also use glass containers, cake pans and special oven trays suitable for use in your oven (available in kitchenware shops). Pay attention to the information given by the supplier for use of this cookware. The information given below should be implemented for enameled containers.

If the food to be cooked does not completely cover the oven tray, if the food is taken out of the deep-freezer or if the tray is used to collect the dripping juices of the foods during the grill operation, deformation might be observed on the tray over time due to high temperatures forming during the cooking/baking operation. This is a normal, physical state that results during the heat transfer. Do not leave a glass tray or container in a cold environment immediately after cooking in them. Do not place them on cold and wet surfaces. Ensure that they slowly cool off by placing them on a dry piece of cloth or wooden board, otherwise, the glass tray or container might break. If you are going to use the large wire oven rack/grill, insert a tray into one of the lower racks to collect fat or oil. To make cleaning easier, add some water into this tray. In a grilling operation, use the shelf in position 5.

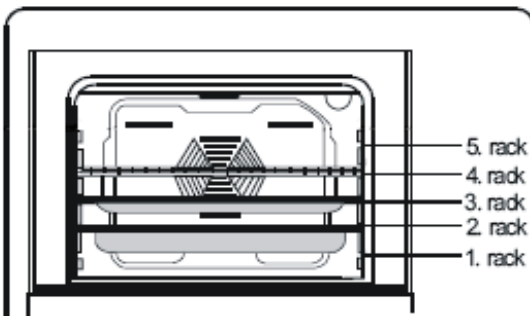

Wire Grid: Used for grills or for placing different containers other than the cooking tray on it.

Shallow Tray: Used for baking pastry such as flans etc.

Deep Tray: Used for cooking stews.

Pan anti-tilting wire

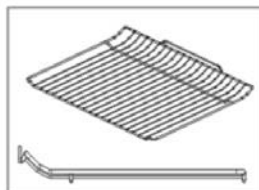

- To locate grid correctly in the cavity, put it to any rack and push the grid up to the end.
- The pan anti-tilting wire must be placed inside of the cavity.

CLEANING



NOTE: Cleaning and maintenance operations must only be carried out when the oven is cool.

The appliance should be disconnected from the power outlet or turned off at your isolation switch before commencing any cleaning process.

Cleaning the oven exterior:

Before starting to clean your oven, be sure that all control buttons are off and your appliance has cooled. Unplug the appliance.

Do not use cleaning materials containing particles that might scratch the enameled and painted parts of your oven. Use cream cleaners or liquid cleaners, which do not contain particles. As these cleaners may damage the surfaces, do not use caustic creams, abrasive cleaning powders, rough wire wool or hard tools. In the event of any excess liquids spilling over your oven surface during cleaning, clean up immediately so as to prevent possible damage to the enamel or metal surface. Do not use steam cleaners for cleaning the oven.

Cleaning the interior of the oven:

Make sure to unplug the oven before starting to clean it. You will obtain best results if you clean the oven interior while the oven is slightly warm (the oven should not be operating). Wipe your oven with a soft piece of cloth (e.g. dish cloth) dampened with warm soapy water after each use, rinse cloth in warm water then wipe oven again and finish by wiping with a dry cloth. For a complete cleaning process, use dry and powder type oven cleaners, following the oven cleaning product's instructions.

TROUBLESHOOTING

If the oven does not operate:

- The oven may be unplugged from the power source or switched off at the power source.
- The household fuse has blown or household power supply is off.
- The Timer (if available) may not set correctly.

If the oven does not heat:

- The heat may not be set correctly with the oven's temperature setting.

If the interior lighting lamp does not light:

- The lamps are defective. If they are defective, you can change them following the instructions within this manual.

Cooking (if lower-upper part does not cook equally):

- Control the shelf locations, cooking period and heat values according to the manual.

Unit smoking when first used:

- This is a result of protective oils being removed and is to be expected with a first use.

Clock Flashing on Display:

- Power failure or interruption

If you have any further problems with your product, please call your Authorised Service Centre.

TRANSPORTATION

Keep the original carton of the product and use this packaging if the item needs to be transported. Follow the transport signs on the carton. Place paper between the upper cover and cooking panel; cover the upper cover, tape to the side surfaces of oven.

Tape cardboard or paper onto the inside face of the glass as it will be susceptible to damage from the trays. Use cardboard covers for the wire grill and trays in your oven. Also tape the oven's covers to the side walls.

If the original carton is unavailable, take measures to protect the external surfaces (glass and painted surfaces) of oven against possible blows, as well as the above.

RECOMMENDED COOKING TIMES

FOOD	LOWER-UPPER HEAT – (Conventional)			LOWER-UPPER HEAT + FAN (Fan Assist)		
	Thermostat pos. (°c)	Rack pos.	Cooking Period (min)	Thermostat pos (°c)	Rack pos.	Cooking Period (min)
Scones Plain or fruit	220	2-3	10-15	210	2-3	10-15
Cake - Butter cake (deep)	180	2-3	40	170	2-3	40
Cake - Sponge	180	2-3	25-30	170	2-3	25-30
Cake – Cup cakes	180	2-3	10-15	170	2-3	10-15
Cookies – Choc chip	180	2-3	15-20	170	2-3	15-20
Biscuits - Anzac	180	2-3	15-20	170	2-3	15-20
Brownie	180	2-3	30-40	170	2-3	30-40
Banana Loaf	180	2-3	40-50	170	2-3	40-50
Pavlova	110	2-3	90	100	2-3	90
Meringues - Hard	110	2-3	90	100	2-3	90
Pastry (pre-rolled frozen)	190-200	2-3	20-30	180-190	2-3	20-30
Pastry - Savoury homemade	180-200	2-3	20-30	170-190	2-3	20-30
Pastry –Sweet homemade	180-190	2-3	20-30	170-180	2-3	20-30
Pizza - home made	220	2-3	10-15	220	1	10-15
Chips - Oven baked	220	2-3	30-40	210	1	30-40

FOOD	LOWER-UPPER HEAT– (Conventional)			LOWER-UPPER HEAT + FAN (Fan Assist)		
	Thermostat pos. (°c)	Rack pos.	Cooking Period (min)	Thermostat pos (°c)	Rack pos.	Cooking Period (min)
Roast Pork	230 + 190	2-3	20 + 45/50 min per kilo	220 +180	2-3	20 + 45/50 min per kilo
Roast Chicken	190 - 200	2-3	50-60 min per kilo	180-190	2-3	50-60 min per kilo
Roast Beef - rare	190-200	2-3	15-20 mins per 500g	180-190	2-3	15-20 mins per 500g
Roast Beef - medium	190-200	2-3	25 mins per 500g	180-190	2-3	25 mins per 500g
Roast Beef - well done	190-200	2-3	30 mins per 500g	180-190	2-3	30 mins per 500g
Roast Lamb - medium	190-200	2-3	20 mins per 500g	180-190	2-3	20 mins per 500g
Roast Lamb - well done	190-200	2-3	30 mins per 500g	180-190	2-3	30 mins per 500g
Roast Turkey	180	2-3	40-45 mins per kilo	170	2-3	4-45 mins per 500g
Roast Duck	180-200	2-3	30-35 mins per 500g	170-190	2-3	30-35 mins per 500g
Roast Veal – well done	180	2-3	30 mins per 500g	170	2-3	30 mins per 500g
Baked whole fish	180	2-3	15-20 min per kilo	170	2-3	15-20 min per kilo
Casserole/ moist dishes	180	2-3	60-80 mins	170	2-3	60-80 mins
Roast Pumpkin	220	2-3	20-40 mins depends on size of pieces	200	2-3	20-40 mins depends on size of pieces

COOKING GUIDES

- For optimum cooking keep edges of baking dishes and pans at least 4cm from the sides of the oven. This allows free heat circulation and ensures even cooking.
- Where possible remove large cuts of meat 1kg or over from the fridge 1 hour prior to cooking. Allow, to stand covered and away from direct sun/heat. This process will take the “chill” of the fridge away from the food and assist in more even cooking.

Oven Shelf Location

Your Omega oven has five positions of racks for the oven shelves to be positioned depending on your choice of cooking function and size of roasting dishes or containers. These are numbered from 1 (the lowest shelf position) to 5 (the highest shelf position). See diagram in oven manual.

To obtain maximum space above and below the shelves, it is recommended that you position trays and dishes in the following way:

- When using only 1 shelf, use position/rack 2 or 3 (That's oven shelf position).
- When using 2 shelves, use position/rack 2 and 4.

Cooking Pizza

For the best results when cooking pizza use the Fan forced with Lower Heat Element function. Preheat the oven for at least 10 minutes.

- Use a non-stick pizza pan, ideally one with holes in the base specifically for pizza cooking.
- Do not open the oven door frequently while the pizza is cooking.
- If the pizza has a lot of toppings (three or four), it is recommended that the mozzarella cheese be placed on top halfway through the cooking process. Remember the best pizzas are made with a less is best method when choosing the topping ingredients.
- Check the base is crispy by lifting the pizza pan from the oven with a heatproof glove and lifting the pizza with an oven slide to look at the pizza base. Return to oven if further cooking is required.

Roasting Meat, Cooking Chicken and Fish

- Ideally, meat should be at least 1Kg or more when roasting in order to prevent it from drying out.
- When cooking white meat, poultry and fish, use temperature settings (180°C-220°C).
- For red meat that should be well done on the outside while tender and juicy on the inside, it is a good idea to start with a high temperature setting (200°C-220°C) for a short time, then turn the oven down afterwards and finish off.
- When larger cuts of meat, poultry or fish have finished cooking, ideally remove the food from oven and cover with foil and stand for 10-20 minutes (depending on size). This will help retain the juices when the meat is carved.
- When cooking large whole fish (1kg or larger) it is recommended that the flesh be scored or slashed 2- 3 times on either side to assist in more even cooking. To do this cut into the thick fish flesh behind the head through to the bone. These scored areas also allow you to check easily to see if the fish is cooked.
- It is a good idea to either measure the inside of your oven for width and either write this down in a book you may have with you when shopping or you can cut a piece of string the oven width, this makes it easier to know if your fish will fit into the oven. Looks can be deceiving and the fish looks so much better whole with its head and tail. If it doesn't fit you will probably need to remove the head prior to baking.

Grilling

Cooking times may vary according to the nature of the foods, their homogeneity and their volume. When cooking a certain food for the first time, it is advisable to choose the lowest temperature and then increase temperature as required.

Cakes and Baking

Organize the oven shelves while the oven is cold and before preparing a recipe. When baking follow the directions in the recipe however if in doubt as a general rule the food (e.g. cake) is positioned on a shelf that will have the top of the cake surface as near to the centre of the oven as possible.

- Preheat oven before preparing the cake or baked items as some baked food does not like to sit waiting for the oven to reach the required temperature. For best results the baked food should go straight into the preheated oven at the correct temperature.
- Use kitchen baking paper to line cake tins and baking trays for cookies and roast vegetables such as pumpkin.
- When making cakes have eggs at room temperature.
- When making sponge cakes don't tap the beaters on the side of the bowl when the beating is complete as this will knock out precious air you have just spent time adding. Remove the beaters from the hand mixer and tap them over the edge of your open palm to knock any remaining cake mix into the bowl below.

Pavlova and Meringues

- Eggs should be at room temperature.
- Ensure that the bowl and beaters to be used are super clean and have no grease, oil or fat on them as this will retard the beating and peak forming process.
- It is a good idea to crack the eggs to be used one at a time over a small bowl to separate the egg yolks and whites that way if a yolk does break it will not end up in your main bowl of egg whites.
- When making pavlova or meringues don't tap the beaters on the side of the bowl when the beating is complete as this will knock out precious air you have just spent time adding. Remove the beaters from the hand mixer and tap them over the edge of your open palm to knock any remaining mix into the bowl below.
- Line baking trays with kitchen baking paper.
- When they are cooked, remove the tray from the oven and use a very flat spatula to loosen the food from the baking paper. Return the Pavlova or meringues to the oven and allow to stand overnight or until the oven is cold for best results.

Think about using the remaining egg yolks to make homemade mayonnaise.

Omega products are distributed in
Australia by Shriro Australia Pty Ltd.
Locked Bag 5002, Kingsgrove NSW 2208
Phone: 1300 795 572 Fax: (02) 9415 5525
Email: service@shriro.com.au
Web: www.omegaappliances.com.au