

**GARMIN®**

# MARQ<sup>®</sup> AVIATOR

---

Owner's Manual

© 2019 Garmin Ltd. or its subsidiaries

All rights reserved. Under the copyright laws, this manual may not be copied, in whole or in part, without the written consent of Garmin. Garmin reserves the right to change or improve its products and to make changes in the content of this manual without obligation to notify any person or organization of such changes or improvements. Go to [www.garmin.com](http://www.garmin.com) for current updates and supplemental information concerning the use of this product.

Garmin®, the Garmin logo, ANT®, ANT+®, Approach®, Auto Lap®, Auto Pause®, ConnexT®, Edge®, inReach®, MARQ®, QuickFit®, TracBack®, VIRB®, Virtual Partner®, and Xero® are trademarks of Garmin Ltd. or its subsidiaries, registered in the USA and other countries. Body Battery™, Connect IQ™, Firstbeat Analytics™, Garmin Connect™, Garmin Express™, Garmin Golf™, Garmin Index™, Garmin Move IQ™, Garmin Pay™, Garmin Pilot™, HRM-Pro™, HRM-Run™, HRM-Tri™, HRM-Swim™, Rally™, tempe™, TruSwing™, TrueUp™, Varia™, and Vector™ are trademarks of Garmin Ltd. or its subsidiaries. These trademarks may not be used without the express permission of Garmin.

Android™ is a trademark of Google Inc. Apple®, iPhone®, iTunes®, and Mac® are trademarks of Apple Inc., registered in the U.S. and other countries. The BLUETOOTH® word mark and logos are owned by the Bluetooth SIG, Inc. and any use of such marks by Garmin is under license. The Cooper Institute®, as well as any related trademarks, are the property of The Cooper Institute. Di2™ is a trademark of Shimano, Inc. Shimano® is a registered trademark of Shimano, Inc. iOS® is a registered trademark of Cisco Systems, Inc. used under license by Apple Inc. The Spotify® software is subject to third-party licenses found here: <https://developer.spotify.com/legal/third-party-licenses>. STRAVA and Strava™ are trademarks of Strava, Inc. Training Stress Score™ (TSS), Intensity Factor™ (IF), and Normalized Power™ (NP) are trademarks of Peaksware, LLC. Wi-Fi® is a registered mark of Wi-Fi Alliance Corporation. Windows® is a registered trademark of Microsoft Corporation in the United States and other countries. Zwift™ is a trademark of Zwift, Inc. Other trademarks and trade names are those of their respective owners.

This product is ANT+® certified. Visit [www.thisisant.com/directory](http://www.thisisant.com/directory) for a list of compatible products and apps.

# Table of Contents

<b>Introduction.....</b>	<b>1</b>	<b>Activities and Apps.....</b>	<b>11</b>
Overview.....	1	Starting an Activity.....	11
Adding Alternate Time Zones to the		Tips for Recording Activities.....	11
Watch Face.....	2	Changing the Power Mode.....	11
Viewing the Controls Menu.....	2	Stopping an Activity.....	12
Viewing Widgets.....	2	Evaluating an Activity.....	12
Charging the Device.....	3	Adding or Removing a Favorite	
Updating the Aviation Database.....	3	Activity.....	12
Pairing Your Smartphone with Your		Creating a Custom Activity.....	13
Device.....	4	Indoor Activities.....	13
Product Updates.....	4	Going for a Virtual Run.....	13
Setting Up Garmin Express.....	4	Calibrating the Treadmill Distance...	13
		Recording a Strength Training	
		Activity.....	14
		Using an ANT+® Indoor Trainer...	14
<b>Flying.....</b>	<b>4</b>	Outdoor Activities.....	14
Setting the Altitude Alert.....	4	Going for a Track Run.....	15
Setting the Barometric Pressure		Tips for Recording a Track Run....	15
Manually.....	5	Recording an Ultra Run Activity.....	15
Viewing NEXRAD Weather Radar.....	5	Viewing Your Ski Runs.....	16
Flying Activity.....	5	Recording a Backcountry Skiing	
Setting the Auto Fly Value.....	5	Activity.....	16
Starting a Flight.....	6	Cross-Country Skiing Power Data...	16
Viewing Your SpO2 Readings in		Using the Metronome.....	17
Flight.....	6	Playing Audio Prompts During an	
Navigating to the Nearest Airport.....	6	Activity.....	17
Nearest Airport.....	7	Jumpmaster.....	18
Navigating to an Aviation Waypoint by		Multisport.....	18
Its Identifier.....	7	Creating a Multisport Activity.....	18
Viewing Waypoint Information.....	8	Tips for Triathlon Training or Using	
Horizontal Situation Indicator.....	8	Multisport Activities.....	18
Stopping Navigation.....	9	Swimming.....	18
Disabling the Automatic Flight		Swim Terminology.....	19
Timer.....	9	Stroke Types.....	19
Routes and Flight Plans.....	9	Tips for Swimming Activities.....	19
Finding a Waypoint.....	9	Resting During Pool Swimming.....	19
Creating a Flight Plan on Your		Auto Rest.....	20
Device.....	9	Training with the Drill Log.....	20
Connecting to the Garmin Pilot		Turning Off Wrist-based Heart Rate	
App.....	10	While Swimming.....	20
Following a Flight Plan.....	10	Golfing.....	20
Viewing a Flight Plan on the Map....	10	Playing Golf.....	20
Reversing and Following a Flight		Hole Information.....	21
Plan.....	10	Big Numbers Mode.....	22
Editing a Flight Plan.....	10	Measuring Distance with Button	
Deleting a Flight Plan.....	11	Targeting.....	22
		Changing Holes.....	22



Changing the Green.....	22	<b>Safety and Tracking Features.....</b>	<b>32</b>
Moving the Flag.....	23	Adding Emergency Contacts.....	33
Viewing Measured Shots.....	23	Adding Contacts.....	33
Manually Measuring a Shot.....	23	Turning Incident Detection On and	
Viewing Layup and Dogleg		Off.....	33
Distances.....	23	Requesting Assistance.....	33
Saving Custom Targets.....	23	Starting a GroupTrack Session.....	34
Keeping Score.....	24	Tips for GroupTrack Sessions.....	34
Updating a Score.....	24	GroupTrack Settings.....	34
Setting the Scoring Method.....	24		
Setting Your Handicap.....	24	<b>Wi-Fi Connected Features.....</b>	<b>34</b>
Enabling Statistics Tracking.....	25	Connecting to a Wi-Fi Network.....	35
TruSwing™.....	25		
Using the Golf Odometer.....	25	<b>Connect IQ Features.....</b>	<b>35</b>
Viewing PlaysLike Distance.....	25	Downloading Connect IQ Features.....	35
Viewing the Direction to the Pin.....	26	Downloading Connect IQ Features Using	
Viewing Club Statistics.....	26	Your Computer.....	35
Climbing Sports.....	26		
Recording an Indoor Climbing		<b>Garmin Pay.....</b>	<b>35</b>
Activity.....	26	Setting Up Your Garmin Pay Wallet.....	35
Recording a Bouldering Activity.....	27	Paying for a Purchase Using Your	
		Watch.....	36
<b>Connected Features.....</b>	<b>27</b>	Adding a Card to Your Garmin Pay	
Enabling Bluetooth Notifications.....	28	Wallet.....	36
Viewing Notifications.....	28	Managing Your Garmin Pay Cards...	36
Receiving an Incoming Phone Call...	28	Changing Your Garmin Pay	
Replying to a Text Message.....	28	Passcode.....	37
Managing Notifications.....	29		
Turning Off the Bluetooth Smartphone		<b>Music.....</b>	<b>37</b>
Connection.....	29	Connecting to a Third-Party Provider...	37
Turning On and Off Smartphone		Downloading Audio Content from a	
Connection Alerts.....	29	Third-Party Provider.....	37
Locating a Lost Mobile Device.....	29	Downloading Audio Content from	
Garmin Connect.....	30	Spotify®.....	38
Updating the Software Using the		Changing the Music Provider.....	38
Garmin Connect App.....	30	Disconnecting from a Third-Party	
Updating the Software Using Garmin		Provider.....	38
Express.....	31	Downloading Personal Audio	
Using Garmin Connect on Your		Content.....	38
Computer.....	31	Listening to Music.....	39
Manually Syncing Data with Garmin		Music Playback Controls.....	39
Connect.....	31	Connecting Bluetooth Headphones....	39
Garmin Golf™ App.....	31	Changing the Audio Mode.....	39
Connex.....	31		
Connecting to the Garmin Pilot		<b>Heart Rate Features.....</b>	<b>40</b>
App.....	32	Wrist-based Heart Rate.....	40
Pairing a Connex Device.....	32	Wearing the Device.....	40



Tips for Erratic Heart Rate Data.....	40	Performing a Guided Test to Determine Your Lactate Threshold.....	49
Viewing the Heart Rate Widget.....	41	Getting Your FTP Estimate.....	50
Broadcasting Heart Rate Data to Garmin Devices.....	41	Conducting an FTP Test.....	50
Broadcasting Heart Rate Data During an Activity.....	41	Training Status.....	51
Setting an Abnormal Heart Rate Alert.....	42	Training Status Levels.....	52
Turning Off the Wrist-based Heart Rate Monitor.....	42	Tips for Getting Your Training Status.....	52
Running Dynamics.....	42	Heat and Altitude Performance Acclimation.....	52
Training with Running Dynamics.....	43	Training Load.....	52
Color Gauges and Running Dynamics Data.....	43	Training Load Focus.....	53
Ground Contact Time Balance Data.....	44	Recovery Time.....	53
Vertical Oscillation and Vertical Ratio Data.....	44	Viewing Your Recovery Time.....	53
Tips for Missing Running Dynamics Data.....	44	Recovery Heart Rate.....	53
Performance Measurements.....	45	Body Battery™.....	54
Turning Off Performance Notifications.....	45	Viewing the Body Battery Widget.....	54
Detecting Performance Measurements Automatically.....	45	Tips for Improved Body Battery Data.....	54
Syncing Activities and Performance Measurements.....	45	<b>Pulse Oximeter..... 55</b>	
About VO2 Max. Estimates.....	46	Getting Pulse Oximeter Readings.....	55
Getting Your VO2 Max. Estimate for Running.....	46	Turning On All-Day Pulse Oximeter Readings.....	56
Getting Your VO2 Max. Estimate for Cycling.....	47	Turning Off Automatic Pulse Oximeter Readings.....	56
Turning Off VO2 Max. Recording.....	47	Turning On Pulse Oximeter Sleep Tracking.....	56
Viewing Your Fitness Age.....	47	Tips for Erratic Pulse Oximeter Data... ..	56
Viewing Your Predicted Race Times.....	47	<b>Training..... 56</b>	
About Training Effect.....	48	Setting Up Your User Profile.....	56
Heart Rate Variability and Stress Level.....	48	Fitness Goals.....	57
Viewing Your Heart Rate Variability and Stress Level.....	48	About Heart Rate Zones.....	57
Performance Condition.....	49	Setting Your Heart Rate Zones.....	57
Viewing Your Performance Condition.....	49	Letting the Device Set Your Heart Rate Zones.....	58
Lactate Threshold.....	49	Heart Rate Zone Calculations.....	58
		Setting Your Power Zones.....	58
		Activity Tracking.....	58
		Auto Goal.....	59
		Using the Move Alert.....	59
		Sleep Tracking.....	59
		Using Automated Sleep Tracking.....	59
		Using Do Not Disturb Mode.....	59
		Intensity Minutes.....	60



Earning Intensity Minutes.....	60	Restoring a Personal Record.....	70
Garmin Move IQ™.....	60	Clearing a Personal Record.....	70
Activity Tracking Settings.....	60	Clearing All Personal Records.....	70
Turning Off Activity Tracking.....	60	Pausing Your Training Status.....	70
Workouts.....	60	Resuming Your Paused Training	
Following a Workout From Garmin		Status.....	70
Connect.....	61	Enabling Self Evaluation.....	71
Creating a Custom Workout on Garmin		<b>Clocks.....</b>	<b>71</b>
Connect.....	61	Setting an Alarm.....	71
Sending a Custom Workout to Your		Editing an Alarm.....	71
Device.....	61	Starting the Countdown Timer.....	71
Starting a Workout.....	62	Deleting a Timer.....	72
Following a Daily Suggested		Using the Stopwatch.....	72
Workout.....	62	Adding Alternate Time Zones.....	72
Turning Daily Suggested Workout		Editing an Alternate Time Zone.....	73
Prompts On and Off.....	62	<b>Navigation.....</b>	<b>73</b>
Following a Pool Swim Workout.....	62	Saving Your Location.....	73
Recording a Critical Swim Speed		Editing Your Saved Locations.....	73
Test.....	63	Projecting a Waypoint.....	73
Editing Your Critical Swim Speed		Navigating to a Destination.....	74
Result.....	63	Navigating to a Point of Interest.....	74
About the Training Calendar.....	63	Points of Interest.....	74
Using Garmin Connect Training		Creating and Following a Course on Your	
Plans.....	63	Device.....	74
Adaptive Training Plans.....	63	Creating a Round-Trip Course.....	75
Interval Workouts.....	64	Viewing or Editing Course Details.....	75
Creating an Interval Workout.....	64	Using ClimbPro.....	76
Starting an Interval Workout.....	64	Navigating with Sight 'N Go.....	76
Stopping an Interval Workout.....	65	Navigating to Your Starting Point During	
PacePro Training.....	65	an Activity.....	77
Downloading a PacePro Plan from		Viewing Route Directions.....	77
Garmin Connect.....	65	Navigating to the Starting Point of a	
Starting a PacePro Plan.....	66	Saved Activity.....	78
Stopping a PacePro Plan.....	66	Stopping Navigation.....	78
Creating a PacePro Plan on Your		Map.....	78
Watch.....	67	Viewing the Map.....	78
Segments.....	67	Saving or Navigating to a Location on	
Strava™ Segments.....	67	the Map.....	79
Viewing Segment Details.....	67	Navigating with the Around Me	
Racing a Segment.....	68	Feature.....	79
Setting a Segment to Adjust		Changing the Map Theme.....	80
Automatically.....	68	Compass.....	80
Using Virtual Partner®.....	68	Setting the Compass Heading.....	80
Setting a Training Target.....	69	Altimeter and Barometer.....	80
Cancelling a Training Target.....	69	Altimeter Readings.....	80
Racing a Previous Activity.....	69		
Personal Records.....	69		
Viewing Your Personal Records.....	69		



<b>History</b> .....	<b>80</b>	Watch Face Settings.....	97
Using History.....	81	Default Watch Face.....	97
Multisport History.....	81	Customizing the Watch Face.....	98
Viewing Your Time in Each Heart Rate Zone.....	81	Sensors Settings.....	98
Viewing Data Totals.....	81	Compass Settings.....	98
Using the Odometer.....	81	Calibrating the Compass	
Deleting History.....	82	Manually.....	98
		Setting the North Reference.....	99
<b>Customizing Your Device</b> .....	<b>82</b>	Altimeter Settings.....	99
Aviation Settings.....	82	Calibrating the Barometric	
Activities and App Settings.....	83	Altimeter.....	99
Customizing the Data Screens.....	85	Barometer Settings.....	99
Adding a Map to an Activity.....	85	Calibrating the Barometer.....	99
Alerts.....	86	Elevation Settings.....	100
Setting an Alert.....	87	Xero Laser Location Settings.....	100
Activity Map Settings.....	87	Map Settings.....	100
Routing Settings.....	88	Map Themes.....	100
Auto Lap.....	88	Marine Map Settings.....	101
Marking Laps by Distance.....	88	Showing and Hiding Map Data.....	101
Enabling Auto Pause.....	89	Navigation Settings.....	101
Enabling Auto Climb.....	89	Customizing Map Features.....	101
3D Speed and Distance.....	89	Setting Up a Heading Bug.....	101
Turning On and Off the Lap Key.....	89	Setting Navigation Alerts.....	101
Using Auto Scroll.....	90	Power Manager Settings.....	102
Changing the GPS Setting.....	90	Customizing the Battery Saver	
GPS and Other Satellite		Feature.....	102
Systems.....	90	Customizing Power Modes.....	102
UltraTrac.....	90	Restoring a Power Mode.....	103
Power Save Timeout Settings.....	91	System Settings.....	103
Changing the Order of an Activity in the Apps List.....	91	Time Settings.....	103
Widgets.....	92	Setting Time Alerts.....	104
Customizing the Widget Loop.....	93	Syncing the Time.....	104
Altimeter.....	93	Changing the Backlight Settings....	104
Temperature.....	94	Customizing the Hot Keys.....	104
METAR.....	94	Changing the Units of Measure.....	104
inReach Remote.....	95	Viewing Device Information.....	105
Using the inReach Remote.....	95	Viewing E-label Regulatory and	
VIRB Remote.....	95	Compliance Information.....	105
Controlling a VIRB Action			
Camera.....	95	<b>Wireless Sensors</b> .....	<b>105</b>
Controlling a VIRB Action Camera		Pairing Your Wireless Sensors.....	105
During an Activity.....	96	HRM-Pro.....	105
Using the Stress Level Widget.....	96	Extended Display Mode.....	105
Customizing the My Day Widget.....	96	Using an Optional Bike Speed or	
Customizing the Controls Menu.....	97	Cadence Sensor.....	106
		Training with Power Meters.....	106
		Using Electronic Shifters.....	106



Situational Awareness.....	106	The step counts on my device and my Garmin Connect account don't match.....	114
Foot Pod.....	106	The floors climbed amount does not seem accurate.....	115
Improving Foot Pod Calibration....	106	Getting More Information.....	115
Calibrating Your Foot Pod Manually.....	107		
Setting Foot Pod Speed and Distance.....	107		
tempe.....	107		
Club Sensors.....	107		
<b>Device Information.....</b>	<b>108</b>	<b>Appendix.....</b>	<b>116</b>
Specifications.....	108	Data Fields.....	116
Battery Information.....	108	VO2 Max. Standard Ratings.....	123
Data Management.....	108	FTP Ratings.....	123
Deleting Files.....	108	Wheel Size and Circumference.....	124
		Symbol Definitions.....	126
<b>Device Maintenance.....</b>	<b>109</b>	<b>Index.....</b>	<b>127</b>
Device Care.....	109		
Cleaning the Device.....	109		
Changing Integrated QuickFit® Accessories.....	110		
Tips for Adjusting the Metal Bracelet	111		
<b>Troubleshooting.....</b>	<b>111</b>		
My device is in the wrong language... 111			
Is my smartphone compatible with my device?.....	112		
My phone will not connect to the device.....	112		
Can I use my Bluetooth sensor with my watch?.....	112		
My headphones will not connect to the device.....	112		
My music cuts out or my headphones do not stay connected.....	112		
Restarting Your Device.....	113		
Resetting All Default Settings.....	113		
Acquiring Satellite Signals.....	113		
Improving GPS Satellite Reception	113		
The temperature reading is not accurate.....	113		
Maximizing the Battery Life.....	114		
Activity Tracking.....	114		
My daily step count does not appear.....	114		
My step count does not seem accurate.....	114		



# Introduction

## ⚠ WARNING

See the *Important Safety and Product Information* guide in the product box for product warnings and other important information.

Always consult your physician before you begin or modify any exercise program.

This device is not intended to provide primary flight information, and is to be used for backup purposes only.

## Overview

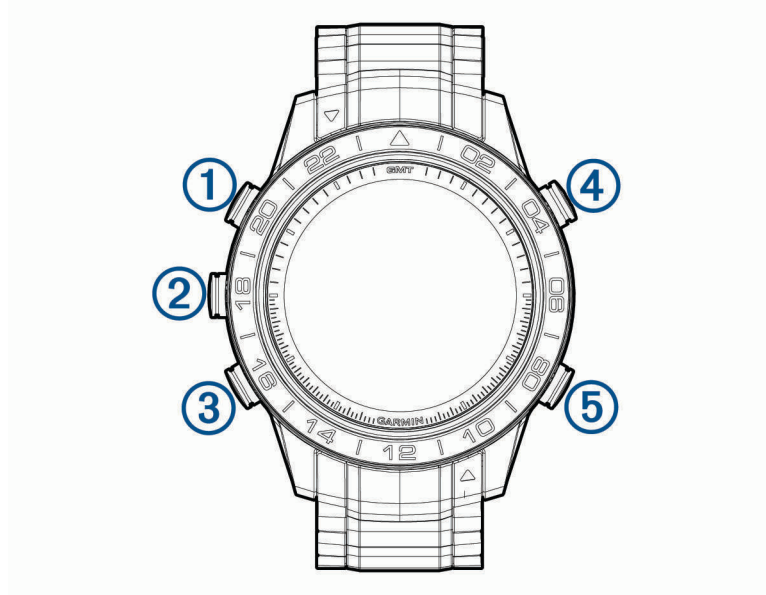

<b>1</b> LIGHT	Press to turn the watch on. Press to turn the backlight on and off. Hold to view the controls menu.
<b>2</b> UP MENU	Press to scroll through the widget loop and menus. Hold to view the menu.
<b>3</b> DOWN	Press to scroll through the widget loop and menus. Hold to view the music controls.
<b>4</b> START STOP 	Press to view the activity list and start or stop an activity. Press to choose an option in a menu. Hold to navigate to an aviation waypoint by its identifier.
<b>5</b> BACK LAP	Press to return to the previous screen. Press to record a lap, rest, or transition during a multisport activity. Hold to navigate to the nearest airport.

## Adding Alternate Time Zones to the Watch Face

During the initial setup, you can select two alternate time zones to appear on the watch face.

- 1 Select an option:
  - Select **Use Airport Ident.** to search for a time zone by entering the alphanumeric identifier for an aviation waypoint.
  - Select **Use Map** to choose a time zone for a geographic location.
- 2 If necessary, select **Yes** to rename the zone.

The current time of day in the selected time zones appears on the watch face.

## Viewing the Controls Menu

The controls menu contains options, such as turning on do not disturb mode, locking the keys, and turning the device off. You can also open the Garmin Pay™ wallet.

**NOTE:** You can add, reorder, and remove the options in the controls menu ([Customizing the Controls Menu, page 97](#)).

- 1 From any screen, hold **LIGHT**.

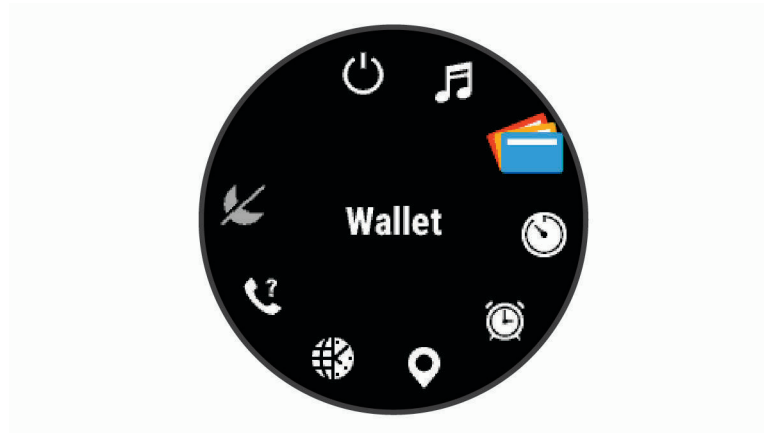

- 2 Press **UP** or **DOWN** to scroll through the options.

## Viewing Widgets

Your device comes preloaded with several widgets, and more are available when you pair your device with a smartphone.

- Press **UP** or **DOWN**.

The device scrolls through the widget loop and displays summary data for each widget.
- Press **START** to view widget details.

**TIP:** You can press **DOWN** to view additional screens for a widget, or press **START** to view additional options and functions for a widget.
- If you are recording an activity, press **BACK** to return to the activity data pages.

## Charging the Device

### ⚠ WARNING

This device contains a lithium-ion battery. See the *Important Safety and Product Information* guide in the product box for product warnings and other important information.

### NOTICE

To prevent corrosion, thoroughly clean and dry the contacts and the surrounding area before charging or connecting to a computer. Refer to the cleaning instructions (*Device Care*, page 109).

- 1 Align the charger posts with the contacts on the back of the device, and connect the charging clip ① securely to the device.

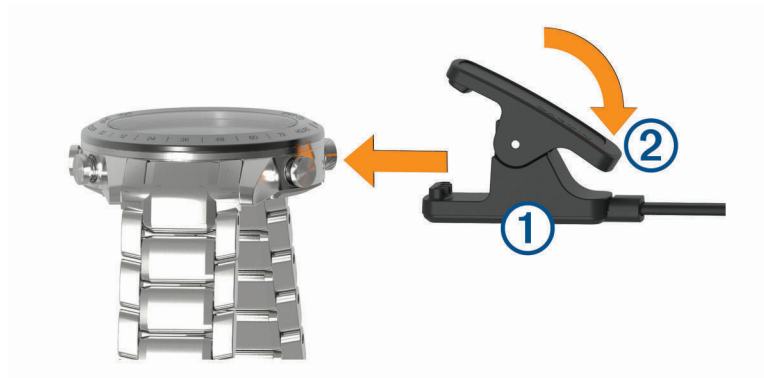

- 2 Plug the USB cable into a USB charging port.
- 3 Charge the device completely.
- 4 Press ② to remove the charger.

## Updating the Aviation Database

Before you can update the aviation database, you must create a Garmin® account and add your device. You can view your unit ID on the device information screen (*Viewing Device Information*, page 105).

The aviation database is valid for 28 days at a time and includes worldwide airport locations, navigational aids, and intersection data.

- 1 Go to [www.flyGarmin.com](http://www.flyGarmin.com).
- 2 Log in to your Garmin account.
- 3 Select an option:
  - Connect your device to a computer using the included USB cable.
  - Connect your device to a Wi-Fi® wireless network.
- 4 Follow the on-screen instructions to update the aviation database.

When your device is connected to a Wi-Fi wireless network, database updates are downloaded automatically overnight.



## Pairing Your Smartphone with Your Device

To use the connected features of the MARQ device, it must be paired directly through the Garmin Connect™ app, instead of from the Bluetooth® settings on your smartphone.

- 1 From the app store on your smartphone, install and open the Garmin Connect app.
- 2 Bring your smartphone within 10 m (33 ft.) of your device.
- 3 Press **LIGHT** to turn on the device.

The first time you turn on the device, it is in pairing mode.

**TIP:** You can hold **LIGHT**, and select  to manually enter pairing mode.

- 4 Select an option to add your device to your Garmin Connect account:
  - If this is the first time you are pairing a device with the Garmin Connect app, follow the on-screen instructions.
  - If you already paired another device with the Garmin Connect app, from the  or  menu, select **Garmin Devices > Add Device**, and follow the on-screen instructions.

## Product Updates

On your computer, install Garmin Express™ ([www.garmin.com/express](http://www.garmin.com/express)). On your smartphone, install the Garmin Connect app.

This provides easy access to these services for Garmin devices:

- Software updates
- Map updates
- Course updates
- Data uploads to Garmin Connect
- Product registration

## Setting Up Garmin Express

- 1 Connect the device to your computer using a USB cable.
- 2 Go to [www.garmin.com/express](http://www.garmin.com/express).
- 3 Follow the on-screen instructions.

## Flying

### **WARNING**

Do not use this device as a primary means of navigation. See the *Important Safety and Product Information* guide in the product box for product warnings and other important information prior to use.

## Setting the Altitude Alert

You can set an alarm to vibrate when you reach a specified altitude.

**NOTE:** The altitude alert is not available in watch mode.

- 1 Hold **MENU**.
- 2 Select **Aviation > Altimeter Settings & Alerts > Altitude Alert > Status > On**.
- 3 Select **Altitude**.
- 4 Select **UP** to select an altitude.

## Setting the Barometric Pressure Manually

You can set the current barometric pressure manually. This can help to improve the accuracy of the pressure altitude reading.

- 1 Hold **MENU**.
- 2 Select **Aviation > Altimeter Settings & Alerts > Barometer > Manual**.
- 3 Select **UP** or **DOWN** to set the current barometric pressure.

## Viewing NEXRAD Weather Radar

Before you can view NEXRAD weather radar, you must pair your device with your smartphone ([Pairing Your Smartphone with Your Device, page 4](#)).

You can view the weather radar image associated with your current location.

**NOTE:** You can customize the **NEXRAD Tiles** option in the **Aviation** settings to download additional weather radar images based on a direction from your current location ([Aviation Settings, page 82](#)).

- 1 At any time, hold **DOWN** and **START** at the same time.

The device downloads a square of radar data for your current GPS position, outlined in magenta. The radar data is active for 5 minutes.

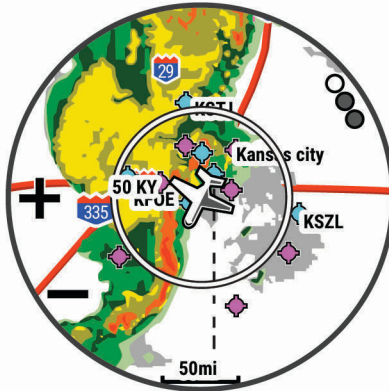

**NOTE:** If you are near the border of the square, you may not see all applicable radar data.

- 2 If necessary, hold **DOWN** and **START** to download new data.

## Flying Activity

A flying activity starts automatically when your detected climb rate exceeds the value you set in the auto fly settings. The default auto fly value is 500 fpm.

You can set up your MARQ device to automatically connect to a paired Connex<sup>®</sup> device when a flying activity starts. This allows your MARQ device to display aircraft information.

## Setting the Auto Fly Value

- 1 Hold **MENU**.
- 2 Select **Activities & Apps > FLY**.
- 3 Select the activity settings.
- 4 Select **Auto Fly**.
- 5 Select the auto fly value.

A flying activity starts automatically when your detected climb rate exceeds this value.

## Starting a Flight

- 1 From the watch face, press **START**.
- 2 Select **FLY**.
- 3 Go outside and wait while the device locates satellites.
- 4 Press **START** to start the flight timer.  
**NOTE:** Your activity data is recorded only while the flight timer is running.
- 5 Start your activity.
- 6 After you complete your activity, press **STOP**, and select **Save**.

## Viewing Your SpO2 Readings in Flight

### ⚠ CAUTION

The SpO2 readings are intended for backup information only. Always defer to applicable flight instruments for primary awareness.

The MARQ device has a wrist-based pulse oximeter to gauge the saturation of oxygen in your blood (SpO2). During a flight, the device automatically takes pulse oximeter readings more frequently, so you can monitor your SpO2 percentage.

**TIP:** You can improve the accuracy of your SpO2 readings by turning on all-day acclimation mode in the pulse oximeter widget settings ([Turning On All-Day Pulse Oximeter Readings, page 56](#)).

During a flight, scroll up or down to view the SpO2 data screen.

Your most recent reading appears as an oxygen saturation percentage and position on the color gauge.



**NOTE:** If you are too active for the device to determine your oxygen saturation, dashes appear instead of a percentage. You should remain stationary for up to 30 seconds while the device reads your blood oxygen saturation.

## Navigating to the Nearest Airport

- 1 Hold **BACK**.  
A list of the nearest airports appears.
- 2 Select an airport.
- 3 Select **Direct-To** to begin navigation.

## Nearest Airport

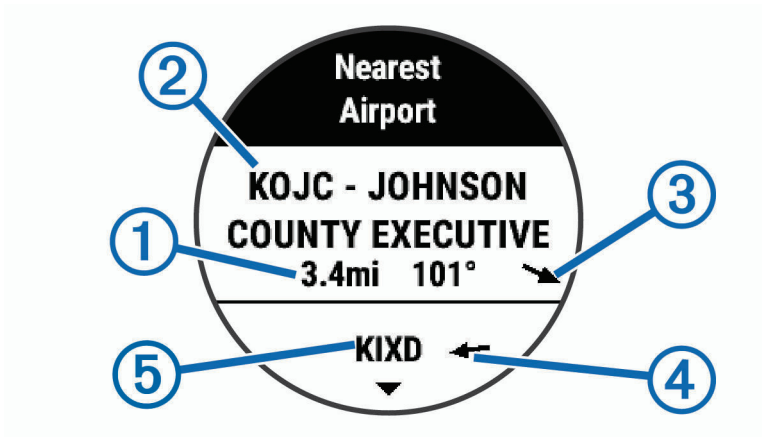

①	Distance to the nearest airport
②	Nearest airport identifier
③	Bearing to the nearest airport
④	Bearing to the second nearest airport
⑤	Second nearest airport identifier

### Navigating to an Aviation Waypoint by Its Identifier

You can navigate directly to an aviation waypoint by searching for an alphanumeric identifier.

- 1 Hold **D**.
- 2 Enter all or part of the alphanumeric identifier.
- 3 Select **✓**.  
A list of matching waypoints appears.
- 4 Select the waypoint.
- 5 Select **Direct-To** to begin navigation.

## Viewing Waypoint Information

You can view information about a location from the list of nearest airports, list of aviation waypoints, or list of waypoints in a flight plan.

1 Select an option to view a list of waypoints:

- To view a list of the nearest airports, hold **BACK** (*Navigating to the Nearest Airport, page 6*).
- To view a list of aviation waypoints, hold **START**, and enter all or part of the alphanumeric identifier (*Navigating to an Aviation Waypoint by Its Identifier, page 7*).
- To find a waypoint, select **START > FLY**, hold **MENU**, select **Navigation > Flight Planning > Find Waypoint**, and select an option (*Finding a Waypoint, page 9*).

2 Select a waypoint.

3 Select an option:

**NOTE:** Options vary by the selected waypoint type.

- To navigate directly to the selected location, select **Direct-To**.
- To download the NEXRAD weather radar image associated with the selected location, select **NEXRAD** (*Viewing NEXRAD Weather Radar, page 5*).
- To show the waypoint on the map, select **Show Map**.
- To view general information, such as the distance and bearing from your current location, select **General Info**.
- To show radio frequencies, select **Frequencies**.
- To show runway information, such as the runway length and surface material, select **Runways**.
- To show METAR and TAF information, select **METARs/TAFs**.

## Horizontal Situation Indicator



- |   |   |
|---|---|
| ① | Configurable navigation data field.   |
| ② | Course deviation indicator (CDI). Indicates the location of the desired course line in relation to your location. |
| ③ | To-and-from indicator. Indicates whether you are headed toward or away from the waypoint.                         |
| ④ | Course deviation distance scale.  |
| ⑤ | Bearing to the nearest airport.   |
| ⑥ | Course deviation distance. The dots indicate your distance off course.  |

## Stopping Navigation

Hold **MENU**, and select **Stop Navigation**.

## Disabling the Automatic Flight Timer

You can disable the automatic flight timer so your device does not automatically record flight data when your ground speed exceeds 30 kn.

- 1 Hold **MENU**.
- 2 Select **Activities & Apps > FLY**.
- 3 Select the activity settings.
- 4 Select **Flight Timer > Manual**.

## Routes and Flight Plans

A route is a sequence of waypoints or locations that leads you to your final destination. Flight plans are routes that use direct routing optimized for aviation. You can create flight plans on your device or by using the Garmin Pilot™ app for mobile devices.

### Finding a Waypoint

- 1 Select **START > FLY**.
- 2 Hold **MENU**.
- 3 Select **Navigation > Flight Planning > Find Waypoint**.
- 4 Select an option:
  - To find a waypoint by name, select **Search by Ident.**
  - To select from a list of the nearest airports, select **Nearest Airports**.
  - To select from a list of the nearest navigational aids, select **Nearest Nav aids**.
  - To select from a list of the nearest intersections, select **Nearest Intersection**.
- 5 Select a location.
- 6 If necessary, select an option to view additional waypoint details ([Viewing Waypoint Information, page 8](#)).

### Creating a Flight Plan on Your Device

- 1 Select **START > FLY**.
- 2 Hold **MENU**.
- 3 Select **Navigation > Flight Planning > Saved Plans > Create New**.
- 4 Enter the name of the flight plan.
- 5 Select **✓**.
- 6 Select **Add Location**.
- 7 Select a category.
- 8 Select the first point on the route.
- 9 Repeat steps 6 through 8 until the route is complete.
- 10 Select **Done** to save the route.

## Connecting to the Garmin Pilot App

You can use the Garmin Pilot app to create flight plans and send them to your MARQ device. The Garmin Pilot app is available for some mobile devices. See the app store for your mobile device for availability and compatibility information.

Your MARQ device connects to the Garmin Pilot app using Bluetooth technology. Go to [www.garmin.com/ble](http://www.garmin.com/ble) for compatibility information.

- 1 Pair your smartphone with your MARQ device (*Pairing Your Smartphone with Your Device, page 4*).
- 2 From the app store on your smartphone, install and open the Garmin Pilot app.
- 3 Sign in to the Garmin Pilot app with your Garmin account login credentials.
- 4 In the Garmin Pilot app, select **Home** > **Connex** > **All Devices**, and select your device.

## Following a Flight Plan

- 1 Select **START** > **FLY**.
- 2 Hold **MENU**.
- 3 Select **Navigation** > **Flight Planning** > **Saved Plans**.
- 4 Select a flight plan.
- 5 Select **Set Active** to begin following the flight plan.

## Viewing a Flight Plan on the Map

- 1 Select **START** > **FLY**.
- 2 Hold **MENU**.
- 3 Select **Navigation** > **Flight Planning** > **Saved Plans**.
- 4 Select a flight plan.
- 5 Select **Map**.

## Reversing and Following a Flight Plan

- 1 Select **START** > **FLY**.
- 2 Hold **MENU**.
- 3 Select **Navigation** > **Flight Planning** > **Saved Plans**.
- 4 Select a flight plan.
- 5 Select **Invert and Save Copy** to reverse the route and save it as a copy of the original flight plan.
- 6 Select the copy of the flight plan.
- 7 Select **Set Active** to begin following the flight plan.

## Editing a Flight Plan

- 1 Select **START** > **FLY**.
- 2 Hold **MENU**.
- 3 Select **Navigation** > **Flight Planning** > **Saved Plans**.
- 4 Select a flight plan.
- 5 Select **Edit**.
- 6 Select an option:
  - To view detailed information about a location, select a location, and select **Details**.
  - To change the order of a location on the route, select a location, and select **Move Up** or **Move Down**.
  - To edit the name of a location, select a location, and select **Name**.
  - To remove a location from the route, select a location, and select **Remove**.
  - To add a location to the route, select **Add Location**.

## Deleting a Flight Plan

- 1 Select **START** > **FLY**.
- 2 Hold **MENU**.
- 3 Select **Navigation** > **Flight Planning** > **Saved Plans**.
- 4 Select a flight plan.
- 5 Select **Delete** > **Yes**.

## Activities and Apps

Your device can be used for indoor, outdoor, athletic, and fitness activities. When you start an activity, the device displays and records sensor data. You can save activities and share them with the Garmin Connect community. You can also add Connect IQ™ activities and apps to your device using the Connect IQ app ([Connect IQ Features, page 35](#)).

For more information about activity tracking and fitness metric accuracy, go to [garmin.com/ataccuracy](http://garmin.com/ataccuracy).

## Starting an Activity

When you start an activity, GPS turns on automatically (if required).

- 1 From the watch face, press **START**.
- 2 Select an option:
  - Select an activity from your favorites.
  - Select , and select an activity from the extended activity list.
- 3 If the activity requires GPS signals, go outside to an area with a clear view of the sky, and wait until the device is ready.

The device is ready after it establishes your heart rate, acquires GPS signals (if required), and connects to your wireless sensors (if required).
- 4 Press **START** to start the activity timer.

The device records activity data only while the activity timer is running.

## Tips for Recording Activities

- Charge the device before starting an activity ([Charging the Device, page 3](#)).
- Press **LAP** to record laps, start a new set or pose, or advance to the next workout step.
- Press **UP** or **DOWN** to view additional data pages.

## Changing the Power Mode

You can change the power mode to extend battery life during an activity.

- 1 During an activity, hold **MENU**.
- 2 Select **Power Mode**.
- 3 Select an option.

The watch displays the hours of battery life gained with the selected power mode.

## Stopping an Activity

- 1 Press **STOP**.
- 2 Select an option:
  - To resume your activity, select **Resume**.
  - To save the activity and return to watch mode, select **Save** > ✓ > **Done**.  
**NOTE:** If self evaluation is enabled, you can enter your perceived effort for the activity ([Enabling Self Evaluation, page 71](#)).
  - To suspend your activity and resume it at a later time, select **Resume Later**.
  - To mark a lap, select **Lap**.
  - To navigate back to the starting point of your activity along the path you traveled, select **Back to Start** > **TracBack**.  
**NOTE:** This feature is available only for activities that use GPS.
  - To navigate back to the starting point of your activity by the most direct path, select **Back to Start** > **Route**.  
**NOTE:** This feature is available only for activities that use GPS.
  - To measure the difference between your heart rate at the end of the activity and your heart rate two minutes later, select **Recovery HR**, and wait while the timer counts down.
  - To discard the activity and return to watch mode, select **Discard** > **Yes**.  
**NOTE:** After stopping the activity, the device saves it automatically after 30 minutes.

## Evaluating an Activity

Before you can evaluate an activity, you must enable the self-evaluation setting on your MARQ device ([Enabling Self Evaluation, page 71](#)).

You can record how you felt during a run, bike, or swim activity.

- 1 After you complete an activity, select **Save** ([Stopping an Activity, page 12](#)).
- 2 Select a number that corresponds with your perceived effort.  
**NOTE:** You can select >> to skip the self evaluation.
- 3 Select how you felt during the activity.

You can view evaluations in the Garmin Connect app.

## Adding or Removing a Favorite Activity

The list of your favorite activities appears when you press **START** from the watch face, and it provides quick access to the activities you use most. You can add or remove favorite activities at any time.

- 1 Hold **MENU**.
- 2 Select **Activities & Apps**.  
Your favorite activities appear at the top of the list.
- 3 Select an option:
  - To add a favorite activity, select the activity, and select **Set as Favorite**.
  - To remove a favorite activity, select the activity, and select **Remove from Favorites**.

## Creating a Custom Activity

- 1 From the watch face, press **START**.
- 2 Select **Add**.
- 3 Select an option:
  - Select **Copy Activity** to create your custom activity starting from one of your saved activities.
  - Select **Other** to create a new custom activity.
- 4 If necessary, select an activity type.
- 5 Select a name or enter a custom name.  
Duplicate activity names include a number, for example: Bike(2).
- 6 Select an option:
  - Select an option to customize specific activity settings. For example, you can customize the data screens or auto features.
  - Select **Done** to save and use the custom activity.
- 7 Select **Yes** to add the activity to your list of favorites.

## Indoor Activities

The MARQ device can be used for training indoors, such as running on an indoor track or using a stationary bike or indoor trainer. GPS is turned off for indoor activities ([Activities and App Settings, page 83](#)).

When running or walking with GPS turned off, speed, distance, and cadence are calculated using the accelerometer in the device. The accelerometer is self-calibrating. The accuracy of the speed, distance, and cadence data improves after a few outdoor runs or walks using GPS.

**TIP:** Holding the handrails of the treadmill reduces accuracy. You can use an optional foot pod to record pace, distance, and cadence.

When cycling with GPS turned off, speed and distance data are not available unless you have an optional sensor that sends speed and distance data to the device, such as a speed or cadence sensor.

## Going for a Virtual Run

You can pair your MARQ device with a compatible third-party app to transmit pace, heart rate, or cadence data.

- 1 Select **START > Virtual Run**.
- 2 On your tablet, laptop, or smartphone, open the Zwift™ app or another virtual training app.
- 3 Follow the on-screen instructions to start a running activity and pair the devices.
- 4 Select **START** to start the activity timer.
- 5 After you complete your run, select **STOP** to stop the activity timer.

## Calibrating the Treadmill Distance

To record more accurate distances for your treadmill runs, you can calibrate the treadmill distance after you run at least 1.5 km (1 mi.) on a treadmill. If you use different treadmills, you can manually calibrate the treadmill distance on each treadmill or after each run.

- 1 Start a treadmill activity ([Starting an Activity, page 11](#)).
- 2 Run on the treadmill until your MARQ device records at least 1.5 km (1 mi.).
- 3 After you complete your run, press **STOP**.
- 4 Select an option:
  - To calibrate the treadmill distance the first time, select **Save**.  
The device prompts you to complete the treadmill calibration.
  - To manually calibrate the treadmill distance after the first-time calibration, select **Calibrate & Save > Yes**.
- 5 Check the treadmill display for the distance traveled, and enter the distance on your device.



## Recording a Strength Training Activity

You can record sets during a strength training activity. A set is multiple repetitions (reps) of a single move.

- 1 From the watch face, press **START**.
- 2 Select **Strength**.
- 3 Select a workout.  
The first time you record a strength training activity, you must select which wrist your watch is on.
- 4 Select **View** to view a list of workout steps (optional).  
**TIP:** While viewing workout steps, you can press **START** to view an animation of the selected exercise, if available.
- 5 Select **Do Workout**.
- 6 Press **START** to start the set timer.
- 7 Start your first set.  
The device counts your reps. Your rep count appears when you complete at least four reps.  
**TIP:** The device can only count reps of a single move for each set. When you want to change moves, you should finish the set and start a new one.
- 8 Press **LAP** to finish the set and move to the next exercise, if available.  
The watch displays the total reps for the set. After several seconds, the rest timer appears.
- 9 If necessary, press **DOWN**, and edit the number of reps.  
**TIP:** You can also add the weight used for the set.
- 10 When you are done resting, press **LAP** to start your next set.
- 11 Repeat for each strength training set until your activity is complete.
- 12 After your last set, press **START** to stop the set timer.
- 13 Select **Save**.

## Using an ANT+® Indoor Trainer

Before you can use a compatible ANT+ indoor trainer, you must mount your bike on the trainer and pair it with your device ([Pairing Your Wireless Sensors](#), page 105).

You can use your device with an indoor trainer to simulate resistance while following a course, ride, or workout. While using an indoor trainer, GPS is turned off automatically.

- 1 From the watch face, press **START**.
- 2 Select **Bike Indoor**.
- 3 Hold **MENU**.
- 4 Select **Smart Trainer Options**.
- 5 Select an option:
  - Select **Free Ride** to go for a ride.
  - Select **Follow Course** to follow a saved course ([Creating and Following a Course on Your Device](#), page 74).
  - Select **Follow Workout** to follow a saved workout ([Workouts](#), page 60).
  - Select **Set Power** to set the target power value.
  - Select **Set Grade** to set the simulated grade value.
  - Select **Set Resistance** to set the resistance force applied by the trainer.
- 6 Press **START** to start the activity timer.  
The trainer increases or decreases resistance based on the elevation information in the course or ride.

## Outdoor Activities

The MARQ device comes preloaded with outdoor activities, such as running and cycling. GPS is turned on for outdoor activities. You can add new activities based on default activities, such as walking or rowing. You can also add custom activities to your device ([Creating a Custom Activity](#), page 13).

## Going for a Track Run

Before you go for a track run, make sure you are running on a standard-shape, 400 m track.

You can use the Track Run activity to record your outdoor track data, including distance in meters and lap splits.

- 1 Stand on the outdoor track.
- 2 From the watch face, press **START**.
- 3 Select **Track Run**.
- 4 Wait while the device locates satellites.
- 5 If you are running in lane 1, skip to step 11.
- 6 Hold **MENU**.
- 7 Select the activity settings.
- 8 Select **Lane Number**.
- 9 Select a lane number.
- 10 Press **BACK** twice to return to the activity timer.
- 11 Press **START** to start the activity timer.
- 12 Run around the track.

After you run a couple of laps, your device records the track dimensions and calibrates your track distance.

- 13 After you complete your run, press **STOP** to stop the activity timer.
- 14 Select **Save**.

### Tips for Recording a Track Run

- Wait until the GPS status indicator turns green before starting a track run.
- During your first run on an unfamiliar track, run for a minimum of 3 laps to calibrate your track distance. You should run slightly past your starting point to complete the lap.
- Run each lap in the same lane.  
**NOTE:** The default Auto Lap<sup>®</sup> distance is 1600 m, or 4 laps around the track.
- If you are running in a lane other than lane 1, set the lane number in the activity settings.

## Recording an Ultra Run Activity

- 1 From the watch face, press **START**.
- 2 Select **Ultra Run**.
- 3 Press **START** to start the activity timer.
- 4 Start running.
- 5 Press **LAP** to record a lap and start the rest timer.  
**NOTE:** You can configure the Lap Key setting to record a lap and start the rest timer, start the rest timer only, or record a lap only ([Activities and App Settings, page 83](#)).
- 6 When you are done resting, press **LAP** to resume running.
- 7 Press **UP** or **DOWN** to view additional data pages (optional).
- 8 After you complete your activity, press **STOP**, and select **Save**.



## Viewing Your Ski Runs

Your device records the details of each downhill skiing or snowboarding run using the auto run feature. This feature is turned on by default for downhill skiing and snowboarding. It automatically records new ski runs based on your movement. The timer pauses when you stop moving downhill and when you are on a chairlift. The timer remains paused during the chairlift ride. You can start moving downhill to restart the timer. You can view run details from the paused screen or while the timer is running.

- 1 Start a skiing or snowboarding activity.
- 2 Hold **MENU**.
- 3 Select **View Runs**.
- 4 Press **UP** and **DOWN** to view details of your last run, your current run, and your total runs.  
The run screens include time, distance traveled, maximum speed, average speed, and total descent.

## Recording a Backcountry Skiing Activity

The backcountry skiing activity lets you manually switch between climbing and descending tracking modes so you can accurately track your statistics.

- 1 From the watch face, press **START**.
- 2 Select **Backcountry Ski**.
- 3 Select an option:
  - If you are starting your activity on a climb, select **Climbing**.
  - If you are starting your activity moving downhill, select **Descending**.
- 4 Press **START** to start the activity timer.
- 5 Press **LAP** to switch between climbing and descending tracking modes.
- 6 After your activity is finished, press **START** to stop the timer.
- 7 Select **Save**.

## Cross-Country Skiing Power Data

You can use your compatible MARQ device paired with the HRM-Pro™ accessory to provide real-time feedback about your cross-country skiing performance.

**NOTE:** The HRM-Pro accessory must be paired to the MARQ device using ANT® technology.

Power is the force you generate while skiing. The power output is measured in watts. Factors that affect power include your speed, elevation changes, wind, and snow conditions. You can use power output to measure and improve your skiing performance.

**NOTE:** Skiing power values are generally lower than cycling power values. This is normal and occurs because humans are less efficient at skiing than they are at cycling. It is common for ski power values to be 30 to 40 percent lower than cycling power values at the same training intensity.

## Using the Metronome

The metronome feature plays tones at a steady rhythm to help you improve your performance by training at a faster, slower, or more consistent cadence.

**NOTE:** This feature is not available for all activities.

- 1 From the watch face, press **START**.
- 2 Select an activity.
- 3 Hold **MENU**.
- 4 Select the activity settings.
- 5 Select **Metronome > Status > On**.
- 6 Select an option:
  - Select **Beats / Minute** to enter a value based on the cadence you want to maintain.
  - Select **Alert Frequency** to customize the frequency of the beats.
  - Select **Sounds** to customize the metronome tone and vibration.
- 7 If necessary, select **Preview** to listen to the metronome feature before you run.
- 8 Go for a run ([Starting an Activity, page 11](#)).  
The metronome starts automatically.
- 9 During your run, press **UP** or **DOWN** to view the metronome screen.
- 10 If necessary, hold **MENU** to change the metronome settings.

## Playing Audio Prompts During an Activity

You can enable your MARQ device to play motivational status announcements during a run or other activity. Audio prompts play on your connected headphones using Bluetooth technology, if available. Otherwise, audio prompts play on your smartphone paired through the Garmin Connect app. During an audio prompt, the device or smartphone mutes the primary audio to play the announcement.

**NOTE:** This feature is not available for all activities.

- 1 Hold **MENU**.
- 2 Select **Audio Prompts**.
- 3 Select an option:
  - To hear a prompt for each lap, select **Lap Alert**.  
**NOTE:** The **Lap Alert** audio prompt is enabled by default.
  - To customize prompts with your pace and speed information, select **Pace/Speed Alert**.
  - To customize prompts with your heart rate information, select **Heart Rate Alert**.
  - To customize prompts with power data, select **Power Alert**.
  - To hear prompts when you start and stop the timer, including the Auto Pause<sup>®</sup> feature, select **Timer Events**.
  - To hear workout alerts play as an audio prompt, select **Workout Alerts**.
  - To hear activity alerts play as an audio prompt, select **Activity Alerts**.
  - To hear a sound play right before an audio alert or prompt, select **Audio Tones**.
  - To change the language or the dialect of the voice prompts, select **Dialect**.



## Jumpmaster

### WARNING

The jumpmaster feature is for use by experienced skydivers only. The jumpmaster feature should not be used as a primary skydiving altimeter. Failure to input the appropriate jump related information can lead to serious personal injury or death.

---

The jumpmaster feature follows military guidelines for calculating the high altitude release point (HARP). The device detects automatically when you have jumped to begin navigating toward the desired impact point (DIP) using the barometer and electronic compass.

## Multisport

Triathletes, duathletes, and other multisport competitors can take advantage of the multisport activities, such as Triathlon or Swimrun. During a multisport activity, you can transition between activities and continue to view your total time. For example, you can switch from biking to running and view your total time for biking and running throughout the multisport activity.

You can customize a multisport activity, or you can use the default triathlon activity set up for a standard triathlon.

### Creating a Multisport Activity

- 1 From the watch face, press **START**.
- 2 Select **Add > Multisport**.
- 3 Select a multisport activity type, or enter a custom name.  
Duplicate activity names include a number. For example, Triathlon(2).
- 4 Select two or more activities.
- 5 Select an option:
  - Select an option to customize specific activity settings. For example, you can select whether to include transitions.
  - Select **Done** to save and use the multisport activity.
- 6 Select **Yes** to add the activity to your list of favorites.

### Tips for Triathlon Training or Using Multisport Activities

- Select **START** to start your first activity.
- Select **LAP** to transition to the next activity.  
If transitions are turned on, the transition time is recorded separately from the activity times.
- If necessary, select **LAP** to start the next activity.
- Select **UP** or **DOWN** to view additional data pages.

## Swimming

### NOTICE

The device is intended for surface swimming. Scuba diving with the device may damage the product and will void the warranty.

---

## Swim Terminology

**Length:** One trip down the pool.

**Interval:** One or more consecutive lengths. A new interval starts after a rest.

**Stroke:** A stroke is counted every time your arm wearing the device completes a full cycle.

**Swolf:** Your swolf score is the sum of the time for one pool length and the number of strokes for that length. For example, 30 seconds plus 15 strokes equals a swolf score of 45. For open water swimming, swolf is calculated over 25 meters. Swolf is a measurement of swimming efficiency and, like golf, a lower score is better.

**Critical swim speed (CSS):** Your CSS is the theoretical speed that you can maintain continuously without exhaustion. You can use your CSS to guide your training pace and monitor your improvement.

## Stroke Types

Stroke type identification is available only for pool swimming. Your stroke type is identified at the end of a length. Stroke types appear in your swimming history and in your Garmin Connect account. You can also select stroke type as a custom data field ([Customizing the Data Screens, page 85](#)).

Free	Freestyle
Back	Backstroke
Breast	Breaststroke
Fly	Butterfly
Mixed	More than one stroke type in an interval
Drill	Used with drill logging ( <a href="#">Training with the Drill Log, page 20</a> )

## Tips for Swimming Activities

- Before starting a pool swimming activity, follow the on-screen instructions to select your pool size or enter a custom size.  
The next time you start a pool swimming activity, the device uses this pool size. You can hold MENU, select the activity settings, and select Pool Size to change the size.
- Press **LAP** to record a rest during pool swimming.  
The device automatically records swim intervals and lengths for pool swimming.
- Press **LAP** to record an interval during open water swimming.

## Resting During Pool Swimming

The default rest screen displays two rest timers. It also displays time and distance for the last completed interval.

**NOTE:** Swim data is not recorded during a rest.

- 1 During your swim activity, press **LAP** to start a rest.  
The display reverses to white text on a black background, and the rest screen appears.
- 2 During a rest, press **UP** or **DOWN** to view other data screens (optional).
- 3 Press **LAP**, and continue swimming.
- 4 Repeat for additional rest intervals.

## Auto Rest

The auto rest feature is available only for pool swimming. Your device automatically detects when you are resting, and the rest screen appears. If you rest for more than 15 seconds, the device automatically creates a rest interval. When you resume swimming, the device automatically starts a new swim interval. You can turn on the auto rest feature in the activity options ([Activities and App Settings, page 83](#)).

**TIP:** For best results using the auto rest feature, minimize your arm motions while resting.

If you do not want to use the auto rest feature, you can select LAP to manually mark the beginning and end of each rest interval.

## Training with the Drill Log

The drill log feature is available only for pool swimming. You can use the drill log feature to manually record kick sets, one-arm swimming, or any type of swimming that is not one of the four major strokes.

- 1 During your pool swim activity, press **UP** or **DOWN** to view the drill log screen.
- 2 Press **LAP** to start the drill timer.
- 3 After you complete a drill interval, press **LAP**.  
The drill timer stops, but the activity timer continues to record the entire swim session.
- 4 Select a distance for the completed drill.  
Distance increments are based on the pool size selected for the activity profile.
- 5 Select an option:
  - To start another drill interval, press **LAP**.
  - To start a swim interval, press **UP** or **DOWN** to return to the swim training screens.

## Turning Off Wrist-based Heart Rate While Swimming

Wrist-based heart rate is turned on by default for swim activities. The device is also compatible with the HRM-Pro accessory and the HRM-Swim™ accessory. If both wrist-based heart rate and chest heart rate data are available, your device uses the chest heart rate data.

- 1 From the heart rate widget, hold **MENU**.  
**NOTE:** You may need to add the widget to your widget loop ([Customizing the Widget Loop, page 93](#)).
- 2 Select **Heart Rate Options > While Swimming > Off**.

## Golfing

### Playing Golf

Before you play golf, you should charge the device ([Charging the Device, page 3](#)).

- 1 From the watch face, press **START**.
- 2 Select **Golf**.
- 3 Go outside, and wait while the device locates satellites.
- 4 Select a course from the list of available courses.
- 5 If necessary, set your driver distance.
- 6 Select **Yes** to keep score.
- 7 Select a tee box.
- 8 After you complete your round, press **START**, and select **End Round**.

## Hole Information

The device shows the current hole you are playing, and automatically transitions when you move to a new hole.

**NOTE:** Because pin locations change, the device calculates the distance to the front, middle, and back of the green, but not the actual pin location.

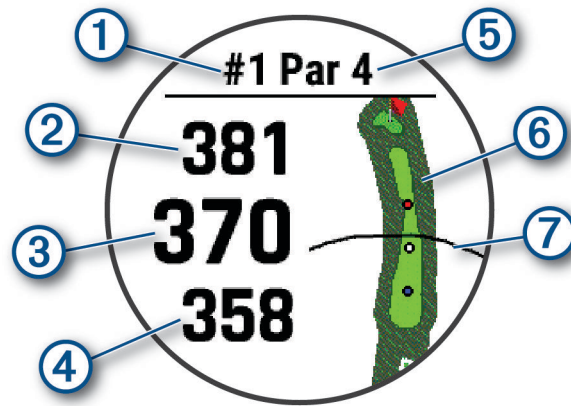

①	Current hole number
②	Distance to the back of the green
③	Distance to the middle of the green
④	Distance to the front of the green
⑤	Par for the hole
⑥	Map of the green
⑦	Driver distance from the tee box

## Big Numbers Mode

You can change the size of the numbers on the hole information screen.

Hold **MENU**, select the activity settings, and select **Big Numbers**.

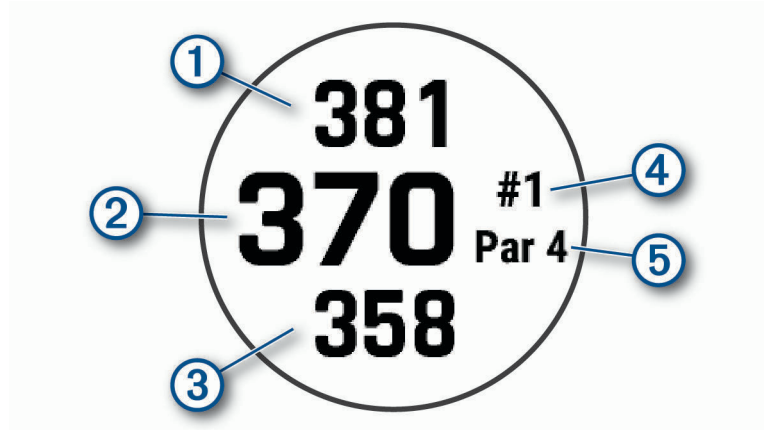

①	The distance to the back of the green
②	The distance to the middle of the green or selected pin position
③	The distance to the front of the green
④	The current hole number
⑤	The par for the current hole

## Measuring Distance with Button Targeting

From the hole information screen, you can use the button targeting feature to measure the distance to a point on the map.

- 1 Press **UP** or **DOWN** to measure the distance to the target.
- 2 If necessary, select **+** or **-** to zoom in or out.

## Changing Holes

You can change holes manually from the hole view screen.

- 1 While playing golf, press **START**.
- 2 Select **Change Hole**.
- 3 Select a hole.

## Changing the Green

If you are playing a hole with more than one green, you can change the green.

- 1 While playing golf, press **START**.
- 2 Select **Change Green**.
- 3 Select a green.

## Moving the Flag

You can take a closer look at the green and move the pin location.

- 1 From the hole information screen, press **START**.
- 2 Select **Move Flag**.
- 3 Press **UP** or **DOWN** to move the pin position.
- 4 Press **START**.

The distances on the hole information screen are updated to show the new pin location. The pin location is saved for only the current round.

## Viewing Measured Shots

Before the device can automatically detect and measure shots, you must enable scoring.

Your device features automatic shot detection and recording. Each time you take a shot along the fairway, the device records your shot distance so you can view it later.

**TIP:** Automatic shot detection works best when you wear the device on your leading wrist and make good contact with the ball. Putts are not detected.

- 1 While playing golf, press **START**.
- 2 Select **Measure Shot**.

Your last shot distance appears.

**NOTE:** The distance automatically resets when you hit the ball again, putt on the green, or move to the next hole.

- 3 Press **DOWN**.
- 4 Select **Previous Shots** to view all recorded shot distances.

## Manually Measuring a Shot

- 1 Take a shot and watch where your ball lands.
- 2 From the hole information screen, press **START**.
- 3 Select **Measure Shot**.
- 4 Press **DOWN**.
- 5 Select **Add Shot > Yes**.
- 6 Walk or drive to your ball.

## Viewing Layup and Dogleg Distances

You can view a list of layup and dogleg distances for par 4 and 5 holes. Custom targets also appear in this list.

- 1 From the hole information screen, press **START**.
- 2 Select **Layups**.

Each layup and the distance until you reach each layup appear on the screen.

**NOTE:** Distances are removed from the list as you pass them.

## Saving Custom Targets

While playing a round, you can save up to five custom targets for each hole. Saving a target is useful for recording objects or obstacles that are not shown on the map. You can view the distances to these targets from the layup and dogleg screen ([Viewing Layup and Dogleg Distances, page 23](#)).

- 1 Stand near the target you want to save.  
**NOTE:** You cannot save a target that is far from the currently selected hole.
- 2 From the hole information screen, press **START**.
- 3 Select **Custom Targets**.
- 4 Select a target type.

## Keeping Score

- 1 From the hole information screen, press **START**.
- 2 Select **Scorecard**.  
The scorecard appears when you are on the green.
- 3 Press **UP** or **DOWN** to scroll through the holes.
- 4 Press **START** to select a hole.
- 5 Press **UP** or **DOWN** to set the score.  
Your total score is updated.

## Updating a Score

- 1 From the hole information screen, press **START**.
- 2 Select **Scorecard**.
- 3 Press **UP** or **DOWN** to scroll through the holes.
- 4 Press **START** to select a hole.
- 5 Press **UP** or **DOWN** to change the score for that hole.  
Your total score is updated.

## Setting the Scoring Method

You can change the method the device uses to keep score.

- 1 From the hole information screen, hold **MENU**.
- 2 Select the activity settings.
- 3 Select **Scoring Method**.
- 4 Select a scoring method.

## About Stableford Scoring

When you select the Stableford scoring method ([Setting the Scoring Method, page 24](#)), points are awarded based on the number of strokes taken relative to par. At the end of a round, the highest score wins. The device awards points as specified by the United States Golf Association.

The scorecard for a Stableford scored game shows points instead of strokes.

Points	Strokes Taken Relative to Par
0	2 or more over
1	1 over
2	Par
3	1 under
4	2 under
5	3 under

## Setting Your Handicap

- 1 From the hole information screen, hold **MENU**.
- 2 Select the activity settings.
- 3 Select **Handicap Scoring**.
- 4 Select a handicap scoring option:
  - To enter the number of strokes to be subtracted from your total score, select **Local Handicap**.
  - To enter the player's handicap index and the course slope rating used to calculate your course handicap, select **Index/Slope**.
- 5 Set your handicap.

## Enabling Statistics Tracking

The Stat Tracking feature enables detailed statistics tracking while playing golf.

- 1 From the hole information screen, hold **MENU**.
- 2 Select the activity settings.
- 3 Select **Stat Tracking** to enable tracking statistics.

## Recording Statistics

Before you can record statistics, you must enable statistics tracking (*Enabling Statistics Tracking, page 25*).

- 1 From the scorecard, select a hole.
- 2 Enter the total number of strokes taken, including putts, and press **START**.
- 3 Set the number of putts taken, and press **START**.

**NOTE:** The number of putts taken is used for statistics tracking only and does not increase your score.

- 4 If necessary, select an option:

**NOTE:** If you are on a par 3 hole, fairway information does not appear.

- If your ball hit the fairway, select **In Fairway**.
- If your ball missed the fairway, select **Missed Right** or **Missed Left**.

- 5 If necessary, enter the number of penalty strokes.

## TruSwing™

Your device is compatible with the TruSwing sensor. You can use the TruSwing app on your watch to view swing metrics recorded from your TruSwing sensor. See the owner's manual for your TruSwing sensor for more information [www.garmin.com/manuals/truswing](http://www.garmin.com/manuals/truswing).

## Using the Golf Odometer

You can use the odometer to record the time, distance, and steps traveled. The odometer automatically starts and stops when you start or end a round.

- 1 From the hole information screen, press **START**.
- 2 Select **Odometer**.
- 3 If necessary, select **Reset** to reset the odometer to zero.

## Viewing PlaysLike Distance

The "plays like" distance feature accounts for elevation changes on the course by showing the adjusted distance to the green.

- 1 From the hole information screen, hold **MENU**.
- 2 Select the activity settings.
- 3 Select **PlaysLike**.

An icon appears next to each distance.



Distance plays longer than expected due to a change in elevation.



Distance plays as expected.



Distance plays shorter than expected due to a change in elevation.

## Viewing the Direction to the Pin

The PinPointer feature is a compass that provides directional assistance when you are unable to see the green. This feature can help you line up a shot even if you are in the woods or in a deep sand trap.

**NOTE:** Do not use the PinPointer feature while in a golf cart. Interference from the golf cart can affect the accuracy of the compass.

- 1 From the hole information screen, press **START**.
- 2 Select **PinPointer**.  
The arrow points to the pin location.

## Viewing Club Statistics

Before you can view your club statistics, such as distance and accuracy information, you must either pair the device with Approach® CT10 golf club sensors (*Club Sensors, page 107*), or enable the Club Prompt setting (*Activities and App Settings, page 83*).

- 1 While playing golf, press **START**.
- 2 Select **Club Stats**.
- 3 Select a club.

## Climbing Sports

### Recording an Indoor Climbing Activity

You can record routes during an indoor climbing activity. A route is a climbing path along an indoor rock wall.

- 1 From the watch face, press **START**.
- 2 Select **Climb Indoor**.
- 3 Select **Yes** to record route statistics.
- 4 Select a grading system.

**NOTE:** The next time you start an indoor climbing activity, the device uses this grading system. You can hold MENU, select the activity settings, and select Grading System to change the system.

- 5 Select the difficulty level for the route.
- 6 Press **START**.
- 7 Start your first route.

**NOTE:** When the route timer is running, the device automatically locks the buttons to prevent accidental button presses. You can hold any button to unlock the watch.

- 8 When you finish the route, descend to the ground.

The rest timer starts automatically when you are on the ground.

**NOTE:** If necessary, you can press LAP to finish the route.

- 9 Select an option:
  - To save a successful route, select **Completed**.
  - To save an unsuccessful route, select **Attempted**.
  - To delete the route, select **Discard**.

- 10 Enter the number of falls for the route.

- 11 When you are done resting, press **LAP** and begin your next route.

- 12 Repeat this process for each route until your activity is complete.

- 13 Press **STOP**.

- 14 Select **Save**.

## Recording a Bouldering Activity

You can record routes during a bouldering activity. A route is a climbing path along a boulder or small rock formation.

- 1 From the watch face, press **START**.
- 2 Select **Bouldering**.
- 3 Select a grading system.  
**NOTE:** The next time you start a bouldering activity, the device uses this grading system. You can hold **MENU**, select the activity settings, and select Grading System to change the system.
- 4 Select the difficulty level for the route.
- 5 Press **START** to start the route timer.
- 6 Start your first route.
- 7 Press **LAP** to finish the route.
- 8 Select an option:
  - To save a successful route, select **Completed**.
  - To save an unsuccessful route, select **Attempted**.
  - To delete the route, select **Discard**.The rest timer appears.
- 9 When you are done resting, press **LAP** to start your next route.
- 10 Repeat this process for each route until your activity is complete.
- 11 After your last route, press **STOP** to stop the route timer.
- 12 Select **Save**.

## Connected Features

Connected features are available for your MARQ device when you connect the device to a compatible smartphone using Bluetooth technology and install the Garmin Connect app on the connected smartphone. Go to [www.garmin.com/apps](http://www.garmin.com/apps) for more information. Some features are also available when you connect your device to a Wi-Fi network.

**Phone notifications:** Displays phone notifications and messages on your MARQ device.

**LiveTrack:** Allows friends and family to follow your races and training activities in real time. You can invite followers using email or social media, allowing them to view your live data on a Garmin Connect tracking page.

**GroupTrack:** Allows you to keep track of your connections using LiveTrack directly on screen and in real time.

**Activity uploads to Garmin Connect:** Automatically sends your activity to your Garmin Connect account as soon as you finish recording the activity.

**Connect IQ:** Allows you to extend your device features with new watch faces, glances, apps, and data fields.

**Software Updates:** Allows you to update your device software.

**Weather:** Allows you to view current weather conditions and weather forecasts. You can also view weather radar on the map.

**Bluetooth sensors:** Allows you to connect Bluetooth compatible sensors, such as a heart rate monitor.

**Find my phone:** Locates your lost smartphone that is paired with your MARQ device and currently within Bluetooth range.

**Find my device:** Locates your lost MARQ device that is paired with your smartphone and currently within Bluetooth range.

## Enabling Bluetooth Notifications

Before you can enable notifications, you must pair the MARQ device with a compatible mobile device ([Pairing Your Smartphone with Your Device](#), page 4).

- 1 Hold **MENU**.
- 2 Select **Phone > Smart Notifications > Status > On**.
- 3 Select **During Activity**.
- 4 Select a notification preference.
- 5 Select a sound preference.
- 6 Select **Not During Activity**.
- 7 Select a notification preference.
- 8 Select a sound preference.
- 9 Select **Privacy**.
- 10 Select a privacy preference.
- 11 Select **Timeout**.
- 12 Select the amount of time the alert for a new notification appears on the screen.
- 13 Select **Signature** to add a signature to your text message replies.

## Viewing Notifications

- 1 From the watch face, press **UP** or **DOWN** to view the notifications widget.
- 2 Press **START**.
- 3 Select a notification.
- 4 Press **START** for more options.
- 5 Press **BACK** to return to the previous screen.

## Receiving an Incoming Phone Call

When you receive a phone call on your connected smartphone, the MARQ device displays the name or phone number of the caller.

- To accept the call, select **Accept**.  
**NOTE:** To talk to the caller, you must use your connected smartphone.
- To decline the call, select **Decline**.
- To decline the call and immediately send a text message reply, select **Reply**, and select a message from the list.  
**NOTE:** This feature is available only if your device is connected to an Android™ smartphone.

## Replying to a Text Message

**NOTE:** This feature is available only for smartphones with Android.

When you receive a text message notification on your MARQ device, you can send a quick reply by selecting from a list of messages. You can customize messages in the Garmin Connect app.

**NOTE:** This feature sends text messages using your phone. Regular text message limits and charges from your carrier and phone plan may apply. Contact your mobile carrier for more information about text message charges or limits.

- 1 From the watch face, press **UP** or **DOWN** to view the notifications widget.
- 2 Press **START**, and select a text message notification.
- 3 Press **START**.
- 4 Select **Reply**.
- 5 Select a message from the list.  
Your phone sends the selected message as an SMS text message.

## Managing Notifications

You can use your compatible smartphone to manage notifications that appear on your MARQ device.

Select an option:

- If you are using an iPhone® device, go to the iOS® notifications settings to select the items to show on the device.
- If you are using an Android smartphone, from the Garmin Connect app, select **Settings > Notifications**.

## Turning Off the Bluetooth Smartphone Connection

You can turn off the Bluetooth smartphone connection from the controls menu.

**NOTE:** You can add options to the controls menu (*Customizing the Controls Menu, page 97*).

- 1 Hold **LIGHT** to view the controls menu.
- 2 Select  to turn off the Bluetooth smartphone connection on your MARQ device.

Refer to the owner's manual for your mobile device to turn off Bluetooth technology on your mobile device.

## Turning On and Off Smartphone Connection Alerts

You can set the MARQ device to alert you when your paired smartphone connects and disconnects using Bluetooth technology.

**NOTE:** Smartphone connection alerts are turned off by default.

- 1 Hold **MENU**.
- 2 Select **Phone > Alerts**.

## Locating a Lost Mobile Device

You can use this feature to help locate a lost mobile device that is paired using Bluetooth technology and currently within range.

**NOTE:** You can add options to the controls menu (*Customizing the Controls Menu, page 97*).

- 1 Hold **LIGHT** to view the controls menu.
- 2 Select .  
The MARQ device begins searching for your paired mobile device. An audible alert sounds on your mobile device, and the Bluetooth signal strength appears on the MARQ device screen. The Bluetooth signal strength increases as you move closer to your mobile device.
- 3 Press **BACK** to stop searching.

## Garmin Connect

Your Garmin Connect account allows you to track your performance and connect with your friends. It gives you the tools to track, analyze, share, and encourage each other. You can record the events of your active lifestyle, including runs, walks, rides, swims, hikes, golf games, and more.

You can create your free Garmin Connect account when you pair your device with your phone using the Garmin Connect app. You can also create an account when you set up the Garmin Express application ([www.garmin.com/express](http://www.garmin.com/express)).

**Store your activities:** After you complete and save a timed activity with your device, you can upload that activity to your Garmin Connect account and keep it as long as you want.

**Analyze your data:** You can view more detailed information about your fitness and outdoor activities, including time, distance, heart rate, calories burned, cadence, an overhead map view, and pace and speed charts. You can view more detailed information about your golf games, including scorecards, statistics, and course information. You can also view customizable reports.

**NOTE:** To view some data, you must pair an optional wireless sensor with your device ([Pairing Your Wireless Sensors](#), page 105).



**Track your progress:** You can track your daily steps, join a friendly competition with your connections, and meet your goals.

**Share your activities:** You can connect with friends to follow each other's activities or post links to your activities on your favorite social networking sites.

**Manage your settings:** You can customize your device and user settings on your Garmin Connect account.

## Updating the Software Using the Garmin Connect App

Before you can update your device software using the Garmin Connect app, you must have a Garmin Connect account, and you must pair the device with a compatible smartphone ([Pairing Your Smartphone with Your Device](#), page 4).

Sync your device with the Garmin Connect app ([Manually Syncing Data with Garmin Connect](#), page 31).

When new software is available, the Garmin Connect app automatically sends the update to your device.

## Updating the Software Using Garmin Express

Before you can update your device software, you must download and install the Garmin Express application and add your device ([Using Garmin Connect on Your Computer, page 31](#)).

- 1 Connect the device to your computer using the USB cable.  
When new software is available, the Garmin Express application sends it to your device.
- 2 After the Garmin Express application finishes sending the update, disconnect the device from your computer.  
Your device installs the update.

## Using Garmin Connect on Your Computer

The Garmin Express application connects your device to your Garmin Connect account using a computer. You can use the Garmin Express application to upload your activity data to your Garmin Connect account and to send data, such as workouts or training plans, from the Garmin Connect website to your device. You can also add music to your device ([Downloading Personal Audio Content, page 38](#)). You can also install device software updates and manage your Connect IQ apps.

- 1 Connect the device to your computer using the USB cable.
- 2 Go to [www.garmin.com/express](http://www.garmin.com/express).
- 3 Download and install the Garmin Express application.
- 4 Open the Garmin Express application, and select **Add Device**.
- 5 Follow the on-screen instructions.

## Manually Syncing Data with Garmin Connect

**NOTE:** You can add options to the controls menu ([Customizing the Controls Menu, page 97](#)).

- 1 Hold **LIGHT** to view the controls menu.
- 2 Select .

## Garmin Golf™ App

The Garmin Golf app allows you to upload scorecards from your compatible Garmin device to view detailed statistics and shot analyses. Golfers can compete with each other at different courses using the Garmin Golf app. More than 42,000 courses have leaderboards that anyone can join. You can set up a tournament event and invite players to compete.

The Garmin Golf app syncs your data with your Garmin Connect account. You can download the Garmin Golf app from the app store on your smartphone.

## Connex

Connex devices deliver a connected cockpit solution. You can wirelessly upload databases and flight plans from your mobile device to your Connex device, and pair your device with your watch to view aircraft information at a glance.

**Garmin Pilot app:** The Garmin Pilot app allows you to create flight plans and send them to your watch ([Connecting to the Garmin Pilot App, page 10](#)).

**Connex devices:** You can pair your watch with compatible Connex devices, such as a Flight Stream 510 device, to display data from your avionics on your watch. For example, weather, GPS position data, and backup altitude information ([Pairing a Connex Device, page 32](#)).

## Connecting to the Garmin Pilot App

You can use the Garmin Pilot app to create flight plans and send them to your MARQ device. The Garmin Pilot app is available for some mobile devices. See the app store for your mobile device for availability and compatibility information.

Your MARQ device connects to the Garmin Pilot app using Bluetooth technology. Go to [www.garmin.com/ble](http://www.garmin.com/ble) for compatibility information.

- 1 Pair your smartphone with your MARQ device (*Pairing Your Smartphone with Your Device*, page 4).
- 2 From the app store on your smartphone, install and open the Garmin Pilot app.
- 3 Sign in to the Garmin Pilot app with your Garmin account login credentials.
- 4 In the Garmin Pilot app, select **Home** > **Connex** > **All Devices**, and select your device.

## Pairing a Connex Device

The first time you connect your MARQ watch to a compatible Connex device, you must pair them using Bluetooth technology.

- 1 Enter pairing mode on your Connex device.
- 2 Bring your watch within 10 m (33 ft.) of your device.
- 3 Hold **MENU**.
- 4 Select **Aviation** > **Connex** > **Pair Connex** > **Status** > **On**.

A prompt appears on your Connex device. After the watch is paired with your device, a message appears on your watch. Aircraft information from the Connex device appears in the data screen loop or custom data fields.

- 5 Select **Start with FLY** (optional).

Your Connex device connects automatically when you start a flying activity on the watch, and the device is active and within range.

## Safety and Tracking Features

### ⚠ CAUTION

The safety and tracking features are supplemental features and should not be relied on as a primary method to obtain emergency assistance. The Garmin Connect app does not contact emergency services on your behalf.

The MARQ device has safety and tracking features that must be set up with the Garmin Connect app.

### NOTICE

To use these features, your device must be connected to the Garmin Connect app using Bluetooth technology. You can enter emergency contacts in your Garmin Connect account.

For more information about safety and tracking features, go to [garmin.com/safety](http://garmin.com/safety).

**Assistance:** Allows you to send a message with your name, LiveTrack link, and GPS location (if available) to your emergency contacts.

**Incident detection:** When the MARQ device detects an incident during an outdoor walk, run, or bike activity, the device sends an automated message, LiveTrack link, and GPS location (if available) to your emergency contacts.

**LiveTrack:** Allows friends and family to follow your races and training activities in real time. You can invite followers using email or social media, allowing them to view your live data on a web page.

**Live Event Sharing:** Allows you to send messages to friends and family during an event, providing real-time updates.

**NOTE:** This feature is available only if your device is connected to an Android smartphone.

**GroupTrack:** Allows you to keep track of your connections using LiveTrack directly on screen and in real time.



## Adding Emergency Contacts

Emergency contact phone numbers are used for the safety and tracking features.

- 1 From the Garmin Connect app, select  or .
- 2 Select **Safety & Tracking > Safety Features > Emergency Contacts > Add Emergency Contacts**.
- 3 Follow the on-screen instructions.

## Adding Contacts

You can add up to 50 contacts to the Garmin Connect app. Contact emails can be used with the LiveTrack feature. Three of these contacts can be used as emergency contacts ([Adding Emergency Contacts, page 33](#)).

- 1 From the Garmin Connect app, select  or .
- 2 Select **Contacts**.
- 3 Follow the on-screen instructions.

After you add contacts, you must sync your data to apply the changes to your MARQ device ([Manually Syncing Data with Garmin Connect, page 31](#)).

## Turning Incident Detection On and Off

- 1 Hold **MENU**.
- 2 Select **Safety & Tracking > Incident Detection**.
- 3 Select an activity.

**NOTE:** Incident detection is available only for outdoor walk, run, and bike activities.

When an incident is detected by your MARQ device with GPS enabled, the Garmin Connect app can send an automated text message and email with your name and GPS location to your emergency contacts. A message appears indicating your contacts will be informed after 30 seconds have elapsed. You can select **Cancel** before the countdown is complete to cancel the message.

## Requesting Assistance

Before you can request assistance, you must set up emergency contacts ([Adding Emergency Contacts, page 33](#)).

- 1 Hold the **LIGHT** key.
- 2 When you feel three vibrations, release the key to activate the assistance feature.  
The countdown screen appears.

**TIP:** You can select **Cancel** before the countdown is complete to cancel the message.

## Starting a GroupTrack Session

Before you can start a GroupTrack session, you must have a Garmin Connect account, a compatible smartphone, and the Garmin Connect app.

These instructions are for starting a GroupTrack session with MARQ devices. If your connections have other compatible devices, you can see them on the map. The other devices may not be able to display GroupTrack riders on the map.

- 1 Go outside, and turn on the MARQ device.
- 2 Pair your smartphone with the MARQ device ([Pairing Your Smartphone with Your Device, page 4](#)).
- 3 On the MARQ device, hold **MENU**, and select **Safety & Tracking > GroupTrack > Show on Map** to enable viewing connections on the map screen.
- 4 In the Garmin Connect app, from the settings menu, select **Safety & Tracking > LiveTrack > ⋮ > Settings > GroupTrack**.
- 5 Select **All Connections**.
- 6 Select **Start LiveTrack**.
- 7 On the MARQ device, start an activity.
- 8 Scroll to the map to view your connections.

**TIP:** From the map, you can hold **MENU** and select **Nearby Connections** to view distance, direction, and pace or speed information for other connections in the GroupTrack session.

## Tips for GroupTrack Sessions

The GroupTrack feature allows you to keep track of other connections in your group using LiveTrack directly on the screen. All members of the group must be your connections in your Garmin Connect account.

- Start your activity outside using GPS.
- Pair your MARQ device with your smartphone using Bluetooth technology.
- In the Garmin Connect app, from the settings menu, select **Connections** to update the list of connections for your GroupTrack session.
- Make sure all of your connections pair to their smartphones and start a LiveTrack session in the Garmin Connect app.
- Make sure all your connections are in range (40 km or 25 mi.).
- During a GroupTrack session, scroll to the map to view your connections ([Adding a Map to an Activity, page 85](#)).

## GroupTrack Settings

Hold **MENU**, and select **Safety & Tracking > GroupTrack**.

**Show on Map:** Enables you to view connections on the map screen during a GroupTrack session.

**Activity Types:** Allows you to select which activity types appear on the map screen during a GroupTrack session.

## Wi-Fi Connected Features

**Activity uploads to your Garmin Connect account:** Automatically sends your activity to your Garmin Connect account as soon as you finish recording the activity.

**Audio content:** Allows you to sync audio content from third-party providers.

**Software updates:** Your device downloads and installs the latest software update automatically when a Wi-Fi connection is available.

**Workouts and training plans:** You can browse for and select workouts and training plans on the Garmin Connect site. The next time your device has a Wi-Fi connection, the files are wirelessly sent to your device.

## Connecting to a Wi-Fi Network

You must connect your device to the Garmin Connect app on your smartphone or to the Garmin Express application on your computer before you can connect to a Wi-Fi network.

- 1 Hold **MENU**.
- 2 Select **Wi-Fi > My Networks > Add Network**.  
The device displays a list of nearby Wi-Fi networks.
- 3 Select a network.
- 4 If necessary, enter the password for the network.

The device connects to the network, and the network is added to the list of saved networks. The device reconnects to this network automatically when it is within range.

## Connect IQ Features

You can add Connect IQ features to your watch from Garmin and other providers using the Connect IQ app. You can customize your device with watch faces, data fields, widgets, and device apps.

**Watch Faces:** Allow you to customize the appearance of the clock.

**Data Fields:** Allow you to download new data fields that present sensor, activity, and history data in new ways.  
You can add Connect IQ data fields to built-in features and pages.

**Widgets:** Provide information at a glance, including sensor data and notifications.

**Device Apps:** Add interactive features to your watch, such as new outdoor and fitness activity types.

## Downloading Connect IQ Features

Before you can download features from the Connect IQ app, you must pair your MARQ device with your smartphone (*Pairing Your Smartphone with Your Device*, page 4).

- 1 From the app store on your smartphone, install and open the Connect IQ app.
- 2 If necessary, select your device.
- 3 Select a Connect IQ feature.
- 4 Follow the on-screen instructions.

## Downloading Connect IQ Features Using Your Computer



- 1 Connect the device to your computer using a USB cable.
- 2 Go to [apps.garmin.com](https://apps.garmin.com), and sign in.
- 3 Select a Connect IQ feature, and download it.
- 4 Follow the on-screen instructions.

## Garmin Pay

The Garmin Pay feature allows you to use your watch to pay for purchases in participating stores using credit or debit cards from a participating financial institution.

## Setting Up Your Garmin Pay Wallet

You can add one or more participating credit or debit cards to your Garmin Pay wallet. Go to [garmin.com/garminpay/banks](https://garmin.com/garminpay/banks) to find participating financial institutions.

- 1 From the Garmin Connect app, select  or .
- 2 Select **Garmin Pay > Get Started**.
- 3 Follow the on-screen instructions.

## Paying for a Purchase Using Your Watch

Before you can use your watch to pay for purchases, you must set up at least one payment card.

You can use your watch to pay for purchases in a participating store.

- 1 Hold **LIGHT**.
- 2 Select .
- 3 Enter your four-digit passcode.

**NOTE:** If you enter your passcode incorrectly three times, your wallet locks, and you must reset your passcode in the Garmin Connect app.

Your most recently used payment card appears.





- 4 If you have added multiple cards to your Garmin Pay wallet, select **DOWN** to change to another card (optional).
- 5 Within 60 seconds, hold your watch near the payment reader, with the watch facing the reader. The watch vibrates and displays a check mark when it is finished communicating with the reader.
- 6 If necessary, follow the instructions on the card reader to complete the transaction.

**TIP:** After you successfully enter your passcode, you can make payments without a passcode for 24 hours while you continue to wear your watch. If you remove the watch from your wrist or disable heart rate monitoring, you must enter the passcode again before making a payment.

## Adding a Card to Your Garmin Pay Wallet

You can add up to 10 credit or debit cards to your Garmin Pay wallet.



- 1 From the Garmin Connect app, select  or .
- 2 Select **Garmin Pay** >  > **Add Card**.
- 3 Follow the on-screen instructions.

After the card is added, you can select the card on your watch when you make a payment.

## Managing Your Garmin Pay Cards

You can temporarily suspend or delete a card.

**NOTE:** In some countries, participating financial institutions may restrict the Garmin Pay features.

- 1 From the Garmin Connect app, select  or .
- 2 Select **Garmin Pay**.
- 3 Select a card.
- 4 Select an option:
  - To temporarily suspend or unsuspend the card, select **Suspend Card**. The card must be active to make purchases using your MARQ device.
  - To delete the card, select .

## Changing Your Garmin Pay Passcode

You must know your current passcode to change it. If you forget your passcode, you must reset the Garmin Pay feature for your MARQ device, create a new passcode, and reenter your card information.

- 1 From the MARQ device page in the Garmin Connect app, select **Garmin Pay > Change Passcode**.
- 2 Follow the on-screen instructions.

The next time you pay using your MARQ device, you must enter the new passcode.



## Music

You can download audio content to your device, so you can listen when your smartphone is not nearby. The Garmin Connect app and Garmin Express application allow you to download audio content from a third-party provider or your computer.

You can use the music controls to control music playback on your smartphone or to play music stored on your device. To listen to audio content stored on your device, you must connect headphones with Bluetooth technology.

### Connecting to a Third-Party Provider

Before you can download music or other audio files to your compatible watch from a supported third-party provider, you must connect to the provider using the Garmin Connect app.

- 1 From the Garmin Connect app, select  or .
- 2 Select **Garmin Devices**, and select your device.
- 3 Select **Music**.
- 4 Select an option:
  - To connect to an installed provider, select a provider, and follow the on-screen instructions.
  - To connect to a new provider, select **Get Music Apps**, locate a provider, and follow the on-screen instructions.

### Downloading Audio Content from a Third-Party Provider

Before you can download audio content from a third-party provider, you must connect to a Wi-Fi network ([Connecting to a Wi-Fi Network, page 35](#)).

- 1 Hold **DOWN** from any screen to open the music controls.
- 2 Hold **MENU**.
- 3 Select **Music Providers**.
- 4 Select a connected provider.
- 5 Select a playlist or other item to download to the device.
- 6 If necessary, select **BACK** until you are prompted to sync with the service.

**NOTE:** Downloading audio content can drain the battery. You may be required to connect the device to an external power source if the battery is low.

## Downloading Audio Content from Spotify

Before you can download audio content from Spotify, you must connect to a Wi-Fi network ([Connecting to a Wi-Fi Network](#), page 35).

- 1 Hold **DOWN** from any screen to open the music controls.
- 2 Hold **MENU**.
- 3 Select **Music Providers > Spotify**.
- 4 Select **Add music & podcasts**.
- 5 Select a playlist or other item to download to the device.



**NOTE:** Downloading audio content can drain the battery. You may need to connect the device to an external power source if the remaining battery life is insufficient.

The selected playlists and other items are downloaded to the device.

## Changing the Music Provider

- 1 Hold **DOWN** from any screen to open the music controls.
- 2 Hold **MENU**.
- 3 Select **Music Providers**.
- 4 Select a connected provider.

## Disconnecting from a Third-Party Provider

- 1 From the Garmin Connect app, select  or .
- 2 Select **Garmin Devices**, and select your device.
- 3 Select **Music**.
- 4 Select an installed third-party provider, and follow the on-screen instructions to disconnect the third-party provider from your device.

## Downloading Personal Audio Content

Before you can send your personal music to your device, you must install the Garmin Express application on your computer ([www.garmin.com/express](http://www.garmin.com/express)).









You can load your personal audio files, such as .mp3 and .m4a files, to a MARQ device from your computer. For more information, go to [garmin.com/musicfiles](http://garmin.com/musicfiles).

- 1 Connect the device to your computer using the included USB cable.
- 2 On your computer, open the Garmin Express application, select your device, and select **Music**.  
**TIP:** For Windows® computers, you can select  and browse to the folder with your audio files. For Apple® computers, the Garmin Express application uses your iTunes® library.
- 3 In the **My Music** or **iTunes Library** list, select an audio file category, such as songs or playlists.
- 4 Select the checkboxes for the audio files, and select **Send to Device**.
- 5 If necessary, in the MARQ list, select a category, select the checkboxes, and select **Remove From Device** to remove audio files.

## Listening to Music

- 1 Hold **DOWN** from any screen to open the music controls.
- 2 Connect your headphones with Bluetooth technology ([Connecting Bluetooth Headphones, page 39](#)).
- 3 Hold **MENU**.
- 4 Select **Music Providers**, and select an option:
  - To listen to music downloaded to the watch from your computer, select **My Music** ([Downloading Personal Audio Content, page 38](#)).
  - To control music playback on your smartphone, select **Control Phone**.
  - To listen to music from a third-party provider, select the name of the provider and select a playlist to download.
- 5 Select  to open the music playback controls.

## Music Playback Controls

	Select to manage content from some third-party providers.
	Select to browse the audio files and playlists for the selected source.
	Select to adjust the volume.
	Select to play and pause the current audio file.
	Select to skip to the next audio file in the playlist. Hold to fast forward through the current audio file.
	Select to restart the current audio file. Select twice to skip to the previous audio file in the playlist. Hold to rewind through the current audio file.
	Select to change the repeat mode.
	Select to change the shuffle mode.

## Connecting Bluetooth Headphones

To listen to music loaded onto your MARQ device, you must connect headphones using Bluetooth technology.

- 1 Bring the headphones within 2 m (6.6 ft.) of your device.
- 2 Enable pairing mode on the headphones.
- 3 Hold **MENU**.
- 4 Select **Music > Headphones > Add New**.
- 5 Select your headphones to complete the pairing process.

## Changing the Audio Mode

You can change the music playback mode from stereo to mono.

- 1 Hold **MENU**.
- 2 Select **Music > Audio**.
- 3 Select an option.

# Heart Rate Features

The MARQ device has a wrist-based heart rate monitor and is also compatible with chest heart rate monitors (sold separately). You can view heart rate data on the heart rate widget. If both wrist-based heart rate and chest heart rate data are available when you start an activity, your device uses the chest heart rate data.

## Wrist-based Heart Rate

### Wearing the Device

- Wear the device above your wrist bone.

**NOTE:** The device should be snug but comfortable. For more accurate heart rate readings, the device should not move while running or exercising. For pulse oximeter readings, you should remain motionless.

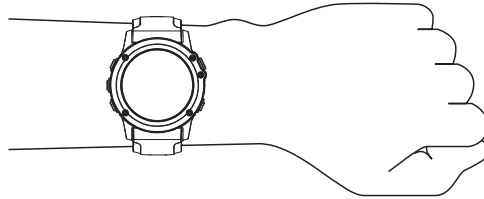

**NOTE:** The optical sensor is located on the back of the device.

- See [Tips for Erratic Heart Rate Data, page 40](#) for more information about wrist-based heart rate.
- See [Tips for Erratic Pulse Oximeter Data, page 56](#) for more information about the pulse oximeter sensor.
- For more information about accuracy, go to [garmin.com/ataccuracy](https://garmin.com/ataccuracy).
- For more information about device wear and care, go to [www.garmin.com/fitandcare](https://www.garmin.com/fitandcare).

### Tips for Erratic Heart Rate Data

If the heart rate data is erratic or does not appear, you can try these tips.

- Clean and dry your arm before putting on the device.
- Avoid wearing sunscreen, lotion, and insect repellent under the device.
- Avoid scratching the heart rate sensor on the back of the device.
- Wear the device above your wrist bone. The device should be snug but comfortable.
- Wait until the ♥ icon is solid before starting your activity.
- Warm up for 5 to 10 minutes and get a heart rate reading before starting your activity.

**NOTE:** In cold environments, warm up indoors.

- Rinse the device with fresh water after each workout.

## Viewing the Heart Rate Widget

- 1 From the watch face, press **UP** or **DOWN** to view the heart rate widget.  
**NOTE:** You may need to add the widget to your widget loop ([Customizing the Widget Loop, page 93](#)).
- 2 Press **START** to view your current heart rate in beats per minute (bpm) and a graph of your heart rate for the last 4 hours.

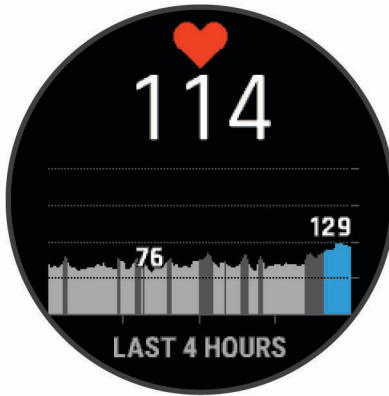

- 3 Press **DOWN** to view your average resting heart rate values for the last 7 days.

## Broadcasting Heart Rate Data to Garmin Devices

You can broadcast your heart rate data from your MARQ device and view it on paired Garmin devices.

**NOTE:** Broadcasting heart rate data decreases battery life.

- 1 From the heart rate widget, hold **MENU**.
- 2 Select **Heart Rate Options > Broadcast Heart Rate**.
- 3 Press **START**.  
The MARQ device starts broadcasting your heart rate data, and  appears.
- 4 Pair your MARQ device with your Garmin ANT+ compatible device.  
**NOTE:** The pairing instructions differ for each Garmin compatible device. See your owner's manual.  
**TIP:** To stop broadcasting your heart rate data, press **STOP** from the broadcast heart rate screen.

## Broadcasting Heart Rate Data During an Activity

You can set up your MARQ device to broadcast your heart rate data automatically when you begin an activity. For example, you can broadcast your heart rate data to an Edge® device while cycling, or to a VIRB® action camera during an activity.

**NOTE:** Broadcasting heart rate data decreases battery life.

- 1 From the heart rate widget, hold **MENU**.
- 2 Select **Heart Rate Options > Broadcast During Activity**.
- 3 Begin an activity ([Starting an Activity, page 11](#)).  
The MARQ device starts broadcasting your heart rate data in the background.  
**NOTE:** There is no indication that the device is broadcasting your heart rate data during an activity.
- 4 Pair your MARQ device with your Garmin ANT+ compatible device.  
**NOTE:** The pairing instructions differ for each Garmin compatible device. See your owner's manual.  
**TIP:** To stop broadcasting your heart rate data, stop the activity ([Stopping an Activity, page 12](#)).

## Setting an Abnormal Heart Rate Alert

### CAUTION

This feature only alerts you when your heart rate exceeds or drops below a certain number of beats per minute, as selected by the user, after a period of inactivity. This feature does not notify you of any potential heart condition and is not intended to treat or diagnose any medical condition or disease. Always defer to your health care provider for any heart-related issues.

You can set the heart rate threshold value.

- 1 From the heart rate widget, hold **MENU**.
- 2 Select **Heart Rate Options > Abnormal Heart Rate Alerts**.
- 3 Select **High Alert** or **Low Alert**.
- 4 Set the heart rate threshold value.

Each time your heart rate exceeds or drops below the threshold value, a message appears and the device vibrates.

## Turning Off the Wrist-based Heart Rate Monitor

The default value for the Wrist Heart Rate setting is Auto. The device automatically uses the wrist-based heart rate monitor unless you pair an ANT+ heart rate monitor to the device.

**NOTE:** Disabling the wrist-based heart rate monitor also disables the wrist-based pulse oximeter sensor. You can perform a manual reading from the pulse oximeter widget.

- 1 From the heart rate widget, hold **MENU**.
- 2 Select **Heart Rate Options > Status > Off**.

## Running Dynamics

You can use your compatible MARQ device paired with the HRM-Pro accessory or other running dynamics accessory to provide real-time feedback about your running form.

The running dynamics accessory has an accelerometer that measures torso movement in order to calculate six running metrics.

**Cadence:** Cadence is the number of steps per minute. It displays the total steps (right and left combined).

**Vertical oscillation:** Vertical oscillation is your bounce while running. It displays the vertical motion of your torso, measured in centimeters.

**Ground contact time:** Ground contact time is the amount of time in each step that you spend on the ground while running. It is measured in milliseconds.

**NOTE:** Ground contact time and balance are not available while walking.

**Ground contact time balance:** Ground contact time balance displays the left/right balance of your ground contact time while running. It displays a percentage. For example, 53.2 with an arrow pointing left or right.

**Stride length:** Stride length is the length of your stride from one footfall to the next. It is measured in meters.

**Vertical ratio:** Vertical ratio is the ratio of vertical oscillation to stride length. It displays a percentage. A lower number typically indicates better running form.

## Training with Running Dynamics

Before you can view running dynamics, you must put on a running dynamics accessory, such as the HRM-Pro accessory, and pair it with your device ([Pairing Your Wireless Sensors, page 105](#)).





- 1 Hold **MENU**.
- 2 Select **Activities & Apps**.
- 3 Select an activity.
- 4 Select the activity settings.
- 5 Select **Data Screens > Add New**.
- 6 Select a running dynamics data screen.  
**NOTE:** The running dynamics screens are not available for all activities.
- 7 Go for a run ([Starting an Activity, page 11](#)).
- 8 Select **UP** or **DOWN** to open a running dynamics screen to view your metrics.

## Color Gauges and Running Dynamics Data

The running dynamics screens display a color gauge for the primary metric. You can display cadence, vertical oscillation, ground contact time, ground contact time balance, or vertical ratio as the primary metric. The color gauge shows you how your running dynamics data compare to those of other runners. The color zones are based on percentiles.

Garmin has researched many runners of all different levels. The data values in the red or orange zones are typical for less experienced or slower runners. The data values in the green, blue, or purple zones are typical for more experienced or faster runners. More experienced runners tend to exhibit shorter ground contact times, lower vertical oscillation, lower vertical ratio, and higher cadence than less experienced runners. However, taller runners typically have slightly slower cadences, longer strides, and slightly higher vertical oscillation. Vertical ratio is your vertical oscillation divided by stride length. It is not correlated with height.





Go to [www.garmin.com/runningdynamics](http://www.garmin.com/runningdynamics) for more information on running dynamics. For additional theories and interpretations of running dynamics data, you can search reputable running publications and websites.

Color Zone	Percentile in Zone	Cadence Range	Ground Contact Time Range
 Purple	>95	>183 spm	<218 ms
 Blue	70–95	174–183 spm	218–248 ms
 Green	30–69	164–173 spm	249–277 ms
 Orange	5–29	153–163 spm	278–308 ms
 Red	<5	<153 spm	>308 ms



## Ground Contact Time Balance Data

Ground contact time balance measures your running symmetry and appears as a percentage of your total ground contact time. For example, 51.3% with an arrow pointing left indicates the runner is spending more time on the ground when on the left foot. If your data screen displays both numbers, for example 48–52, 48% is the left foot and 52% is the right foot.





Color Zone	 Red	 Orange	 Green	 Orange	 Red
Symmetry	Poor	Fair	Good	Fair	Poor
Percent of Other Runners	5%	25%	40%	25%	5%
Ground Contact Time Balance	>52.2% L	50.8–52.2% L	50.7% L–50.7% R	50.8–52.2% R	>52.2% R

While developing and testing running dynamics, the Garmin team found correlations between injuries and greater imbalances with certain runners. For many runners, ground contact time balance tends to deviate further from 50–50 when running up or down hills. Most running coaches agree that a symmetrical running form is good. Elite runners tend to have quick and balanced strides.

You can watch the color gauge or data field during your run or view the summary on your Garmin Connect account after your run. As with the other running dynamics data, ground contact time balance is a quantitative measurement to help you learn about your running form.

## Vertical Oscillation and Vertical Ratio Data

The data ranges for vertical oscillation and vertical ratio are slightly different depending on the sensor and whether it is positioned at the chest (HRM-Pro, HRM-Run™, or HRM-Tri™ accessories) or at the waist (Running Dynamics Pod accessory).

Color Zone	Percentile in Zone	Vertical Oscillation Range at Chest	Vertical Oscillation Range at Waist	Vertical Ratio at Chest	Vertical Ratio at Waist
 Purple	>95	<6.4 cm	<6.8 cm	<6.1%	<6.5%
 Blue	70–95	6.4–8.1 cm	6.8–8.9 cm	6.1–7.4%	6.5–8.3%
 Green	30–69	8.2–9.7 cm	9.0–10.9 cm	7.5–8.6%	8.4–10.0%
 Orange	5–29	9.8–11.5 cm	11.0–13.0 cm	8.7–10.1%	10.1–11.9%
 Red	<5	>11.5 cm	>13.0 cm	>10.1%	>11.9%

## Tips for Missing Running Dynamics Data

If running dynamics data does not appear, you can try these tips.

- Make sure you have a running dynamics accessory, such as the HRM-Pro accessory. Accessories with running dynamics have  on the front of the module.
- Pair the running dynamics accessory with your MARQ device again, according to the instructions.
- If you are using the HRM-Pro accessory, pair it with your MARQ device using ANT+ technology, rather than Bluetooth technology.
- If the running dynamics data display shows only zeros, make sure the accessory is worn right-side up. **NOTE:** Ground contact time and balance appears only while running. It is not calculated while walking.



## Performance Measurements

These performance measurements are estimates that can help you track and understand your training activities and race performances. The measurements require a few activities using wrist-based heart rate or a compatible chest heart rate monitor. Cycling performance measurements require a heart rate monitor and a power meter.

These estimates are provided and supported by Firstbeat. For more information, go to [garmin.com/performance-data/running](https://garmin.com/performance-data/running).

**NOTE:** The estimates may seem inaccurate at first. The device requires you to complete a few activities to learn about your performance.

**VO2 max.:** VO2 max. is the maximum volume of oxygen (in milliliters) you can consume per minute per kilogram of body weight at your maximum performance.

**Predicted race times:** Your device uses the VO2 max. estimate and your training history to provide a target race time based on your current state of fitness.

**HRV stress test:** The heart rate variability (HRV) stress test requires a Garmin chest heart rate monitor. The device records your heart rate variability while standing still for 3 minutes. It provides your overall stress level. The scale is 1 to 100, and a lower score indicates a lower stress level.

**Performance condition:** Your performance condition is a real-time assessment after 6 to 20 minutes of activity. It can be added as a data field so you can view your performance condition during the rest of your activity. It compares your real-time condition to your average fitness level.

**Functional threshold power (FTP):** The device uses your user profile information from the initial setup to estimate your FTP. For a more accurate rating, you can conduct a guided test.

**Lactate threshold:** Lactate threshold requires a chest heart rate monitor. Lactate threshold is the point where your muscles start to rapidly fatigue. Your device measures your lactate threshold level using heart rate data and pace.

## Turning Off Performance Notifications

Some performance notifications appear upon completion of your activity. Some performance notifications appear during an activity or when you achieve a new performance measurement, such as a new VO2 max. estimate. You can turn off the performance condition feature to avoid some of these notifications.

- 1 Hold **MENU**.
- 2 Select **Physiological Metrics > Perf. Condition**.

## Detecting Performance Measurements Automatically

The Auto Detection feature is turned on by default. The device can automatically detect your maximum heart rate and lactate threshold during an activity. When paired with a compatible power meter, the device can automatically detect your functional threshold power (FTP) during an activity.

**NOTE:** The device detects a maximum heart rate only when your heart rate is higher than the value set in your user profile.

- 1 Hold **MENU**.
- 2 Select **Physiological Metrics > Auto Detection**.
- 3 Select an option.

## Syncing Activities and Performance Measurements

You can sync activities and performance measurements from other Garmin devices to your MARQ device using your Garmin Connect account. This allows your device to more accurately reflect your training status and fitness. For example, you can record a ride with an Edge device, and view your activity details and overall training load on your MARQ device.

- 1 Hold **MENU**.
- 2 Select **Physiological Metrics > TrueUp**.

When you sync your device with your smartphone, recent activities and performance measurements from your other Garmin devices appear on your MARQ device.

## About VO2 Max. Estimates

VO2 max. is the maximum volume of oxygen (in milliliters) you can consume per minute per kilogram of body weight at your maximum performance. In simple terms, VO2 max. is an indication of athletic performance and should increase as your level of fitness improves. The MARQ device requires wrist-based heart rate or a compatible chest heart rate monitor to display your VO2 max. estimate. The device has separate VO2 max. estimates for running and cycling. You must run either outside with GPS or ride with a compatible power meter at a moderate level of intensity for several minutes to get an accurate VO2 max. estimate.

On the device, your VO2 max. estimate appears as a number, description, and position on the color gauge. On your Garmin Connect account, you can view additional details about your VO2 max. estimate, such as where it ranks for your age and gender.



 Purple	Superior
 Blue	Excellent
 Green	Good
 Orange	Fair
 Red	Poor

VO2 max. data is provided by Firstbeat Analytics™. VO2 max. analysis is provided with permission from The Cooper Institute®. For more information, see the appendix ([VO2 Max. Standard Ratings, page 123](#)), and go to [www.CooperInstitute.org](http://www.CooperInstitute.org).

### Getting Your VO2 Max. Estimate for Running

This feature requires wrist-based heart rate or a compatible chest heart rate monitor. If you are using a chest heart rate monitor, you must put it on and pair it with your device ([Pairing Your Wireless Sensors, page 105](#)).

For the most accurate estimate, complete the user profile setup ([Setting Up Your User Profile, page 56](#)), and set your maximum heart rate ([Setting Your Heart Rate Zones, page 57](#)). The estimate may seem inaccurate at first. The device requires a few runs to learn about your running performance. You can disable VO2 max. recording for ultra run and trail run activities if you do not want those run types to affect your VO2 max. estimate ([Turning Off VO2 Max. Recording, page 47](#)).

- 1 Run for at least 10 minutes outdoors.
- 2 After your run, select **Save**.
- 3 Select **UP** or **DOWN** to scroll through the performance measurements.

**TIP:** You can select START to view additional information.

## Getting Your VO2 Max. Estimate for Cycling

This feature requires a power meter and wrist-based heart rate or a compatible chest heart rate monitor. The power meter must be paired with your MARQ device ([Pairing Your Wireless Sensors, page 105](#)). If you are using a chest heart rate monitor, you must put it on and pair it with your device.

For the most accurate estimate, complete the user profile setup ([Setting Up Your User Profile, page 56](#)) and set your maximum heart rate ([Setting Your Heart Rate Zones, page 57](#)). The estimate may seem inaccurate at first. The device requires a few rides to learn about your cycling performance.

- 1 Ride at a steady, high intensity for at least 20 minutes.
- 2 After your ride, select **Save**.
- 3 Select **UP** or **DOWN** to scroll through the performance measurements.

**TIP:** You can select **START** to view additional information.

## Turning Off VO2 Max. Recording



You can turn VO2 max. recording off for trail run or ultra run activities ([About VO2 Max. Estimates, page 46](#)).

- 1 Hold **MENU**.
- 2 Select **Activities & Apps**.
- 3 Select an activity.
- 4 Select the activity settings.
- 5 Select **Record VO2 Max. > Off**.

## Viewing Your Fitness Age

Your fitness age gives you an idea of how your fitness compares with a person of the same gender. Your device uses information, such as your age, body mass index (BMI), resting heart rate data, and vigorous activity history to provide a fitness age. If you have a Garmin Index™ scale, your device uses the body fat percentage metric instead of BMI to determine your fitness age. Exercise and lifestyle changes can impact your fitness age.

**NOTE:** For the most accurate fitness age, complete the user profile setup ([Setting Up Your User Profile, page 56](#)).

- 1 From the Garmin Connect app, select  or .
- 2 Select **Health Stats > Fitness Age**.

## Viewing Your Predicted Race Times

For the most accurate estimate, complete the user profile setup ([Setting Up Your User Profile, page 56](#)), and set your maximum heart rate ([Setting Your Heart Rate Zones, page 57](#)).

Your device uses the VO2 max. estimate ([About VO2 Max. Estimates, page 46](#)) and your training history to provide a target race time. The device analyzes several weeks of your training data to refine the race time estimates.

**TIP:** If you have more than one Garmin device, you can enable the Physio TrueUp™ feature, which allows your device to sync activities, history, and data from other devices ([Syncing Activities and Performance Measurements, page 45](#)).

- 1 From the watch face, select **UP** or **DOWN** to view the performance widget.
- 2 Select **START** to scroll through the performance measurements.

Your projected race times appear for 5K, 10K, half marathon, and marathon distances.

**NOTE:** The projections may seem inaccurate at first. The device requires a few runs to learn about your running performance.

## About Training Effect

Training Effect measures the impact of an activity on your aerobic and anaerobic fitness. Training Effect accumulates during the activity. As the activity progresses, the Training Effect value increases. Training Effect is determined by your user profile information and training history, and heart rate, duration, and intensity of your activity. There are seven different Training Effect labels to describe the primary benefit of your activity. Each label is color coded and corresponds to your training load focus (*Training Load Focus, page 53*). Each feedback phrase, for example, "Highly Impacting VO2 Max." has a corresponding description in your Garmin Connect activity details.

Aerobic Training Effect uses your heart rate to measure how the accumulated intensity of an exercise affects your aerobic fitness and indicates if the workout had a maintaining or improving effect on your fitness level. Your excess post-exercise oxygen consumption (EPOC) accumulated during exercise is mapped to a range of values that account for your fitness level and training habits. Steady workouts at moderate effort or workouts involving longer intervals (>180 sec) have a positive impact on your aerobic metabolism and result in an improved aerobic Training Effect.

Anaerobic Training Effect uses heart rate and speed (or power) to determine how a workout affects your ability to perform at very high intensity. You receive a value based on the anaerobic contribution to EPOC and the type of activity. Repeated high-intensity intervals of 10 to 120 seconds have a highly beneficial impact on your anaerobic capability and result in an improved anaerobic Training Effect.

You can add Aerobic Training Effect and Anaerobic Training Effect as data fields to one of your training screens to monitor your numbers throughout the activity.

Training Effect	Aerobic Benefit	Anaerobic Benefit
From 0.0 to 0.9	No benefit.	No benefit.
From 1.0 to 1.9	Minor benefit.	Minor benefit.
From 2.0 to 2.9	Maintains your aerobic fitness.	Maintains your anaerobic fitness.
From 3.0 to 3.9	Impacts your aerobic fitness.	Impacts your anaerobic fitness.
From 4.0 to 4.9	Highly impacts your aerobic fitness.	Highly impacts your anaerobic fitness.
5.0	Overreaching and potentially harmful without enough recovery time.	Overreaching and potentially harmful without enough recovery time.

Training Effect technology is provided and supported by Firstbeat Technologies Ltd. For more information, go to [www.firstbeat.com](http://www.firstbeat.com).

## Heart Rate Variability and Stress Level

Stress level is the result of a three-minute test performed while standing still, where the MARQ device analyzes heart rate variability to determine your overall stress. Training, sleep, nutrition, and general life stress all impact how a runner performs. The stress level range is from 1 to 100, where 1 is a very low stress state and 100 is a very high stress state. Knowing your stress level can help you decide if your body is ready for a tough training run or yoga.

### Viewing Your Heart Rate Variability and Stress Level

This feature requires a Garmin chest heart rate monitor. Before you can view your heart rate variability (HRV) stress level, you must put on a heart rate monitor and pair it with your device (*Pairing Your Wireless Sensors, page 105*).

**TIP:** Garmin recommends that you measure your stress level at approximately the same time and under the same conditions every day.

- 1 If necessary, press **START**, and select **Add > HRV Stress** to add the stress app to the apps list.
- 2 Select **Yes** to add the app to your list of favorites.
- 3 From the watch face, press **START**, select **HRV Stress**, and press **START**.
- 4 Stand still, and rest for 3 minutes.

## Performance Condition

As you complete your activity, such as running or cycling, the performance condition feature analyzes your pace, heart rate, and heart rate variability to make a real-time assessment of your ability to perform compared to your average fitness level. It is approximately your real-time percentage deviation from your baseline VO2 max. estimate.

Performance condition values range from -20 to +20. After the first 6 to 20 minutes of your activity, the device displays your performance condition score. For example, a score of +5 means that you are rested, fresh, and capable of a good run or ride. You can add performance condition as a data field to one of your training screens to monitor your ability throughout the activity. Performance condition can also be an indicator of fatigue level, especially at the end of a long training run or ride.

**NOTE:** The device requires a few runs or rides with a heart rate monitor to get an accurate VO2 max. estimate and learn about your running or riding ability ([About VO2 Max. Estimates, page 46](#)).

## Viewing Your Performance Condition

This feature requires wrist-based heart rate or a compatible chest heart rate monitor.

- 1 Add **Performance Condition** to a data screen ([Customizing the Data Screens, page 85](#)).
- 2 Go for a run or ride.  
After 6 to 20 minutes, your performance condition appears.
- 3 Scroll to the data screen to view your performance condition throughout the run or ride.

## Lactate Threshold

Lactate threshold is the exercise intensity at which lactate (lactic acid) starts to accumulate in the bloodstream. In running, it is the estimated level of effort or pace. When a runner exceeds the threshold, fatigue starts to increase at an accelerating rate. For experienced runners, the threshold occurs at approximately 90% of their maximum heart rate and between 10k and half-marathon race pace. For average runners, the lactate threshold often occurs well below 90% of maximum heart rate. Knowing your lactate threshold can help you determine how hard to train or when to push yourself during a race.

If you already know your lactate threshold heart rate value, you can enter it in your user profile settings ([Setting Your Heart Rate Zones, page 57](#)).

## Performing a Guided Test to Determine Your Lactate Threshold

This feature requires a Garmin chest heart rate monitor. Before you can perform the guided test, you must put on a heart rate monitor and pair it with your device ([Pairing Your Wireless Sensors, page 105](#)).

The device uses your user profile information from the initial setup and your VO2 max. estimate to estimate your lactate threshold. The device will automatically detect your lactate threshold during runs at a steady, high intensity with heart rate.

**TIP:** The device requires a few runs with a chest heart rate monitor to get an accurate maximum heart rate value and VO2 max. estimate. If you are having trouble getting a lactate threshold estimate, try manually lowering your maximum heart rate value.

- 1 From the watch face, select **START**.
- 2 Select an outdoor running activity.  
GPS is required to complete the test.
- 3 Hold **MENU**.
- 4 Select **Training > Lactate Threshold Guided Test**.
- 5 Start the timer, and follow the on-screen instructions.  
After you begin your run, the device displays each step duration, the target, and current heart rate data. A message appears when the test is complete.
- 6 After you complete the guided test, stop the timer and save the activity.  
If this is your first lactate threshold estimate, the device prompts you to update your heart rate zones based on your lactate threshold heart rate. For each additional lactate threshold estimate, the device prompts you to accept or decline the estimate.

## Getting Your FTP Estimate

Before you can get your functional threshold power (FTP) estimate, you must pair a chest heart rate monitor and power meter with your device ([Pairing Your Wireless Sensors, page 105](#)), and you must get your VO2 max. estimate ([Getting Your VO2 Max. Estimate for Cycling, page 47](#)).

The device uses your user profile information from the initial setup and your VO2 max. estimate to estimate your FTP. The device will automatically detect your FTP during rides at a steady, high intensity with heart rate and power.

- 1 Select **UP** or **DOWN** to view the performance widget.
- 2 Select **START** to scroll through the performance measurements.

Your FTP estimate appears as a value measured in watts per kilogram, your power output in watts, and a position on the color gauge.

 Purple	Superior
 Blue	Excellent
 Green	Good
 Orange	Fair
 Red	Untrained

For more information, see the appendix ([FTP Ratings, page 123](#)).

**NOTE:** When a performance notification alerts you to a new FTP, you can select Accept to save the new FTP, or Decline to keep your current FTP.

## Conducting an FTP Test

Before you can conduct a test to determine your functional threshold power (FTP), you must pair a chest heart rate monitor and a power meter with your device ([Pairing Your Wireless Sensors, page 105](#)), and you must get your VO2 max. estimate ([Getting Your VO2 Max. Estimate for Cycling, page 47](#)).

**NOTE:** The FTP test is a challenging workout that takes about 30 minutes to complete. Choose a practical and mostly flat route that allows you to ride at a steadily increasing effort, similar to a time trial.

- 1 From the watch face, select **START**.
- 2 Select a cycling activity.
- 3 Hold **MENU**.
- 4 Select **Training > FTP Guided Test**.
- 5 Follow the on-screen instructions.

After you begin your ride, the device displays each step duration, the target, and current power data. A message appears when the test is complete.

- 6 After you complete the guided test, complete the cool down, stop the timer, and save the activity.  
Your FTP appears as a value measured in watts per kilogram, your power output in watts, and a position on the color gauge.
- 7 Select an option:
  - Select **Accept** to save the new FTP.
  - Select **Decline** to keep your current FTP.

## Training Status

These measurements are estimates that can help you track and understand your training activities. The measurements require a few activities using wrist-based heart rate or a compatible chest heart rate monitor. Cycling performance measurements require a heart rate monitor and a power meter.

These estimates are provided and supported by Firstbeat. For more information, go to [garmin.com/performance-data/running](https://garmin.com/performance-data/running).



**NOTE:** The estimates may seem inaccurate at first. The device requires you to complete a few activities to learn about your performance.

**Training status:** Training status shows you how your training affects your fitness and performance. Your training status is based on changes to your training load and VO2 max. over an extended time period.

**VO2 max.:** VO2 max. is the maximum volume of oxygen (in milliliters) you can consume per minute per kilogram of body weight at your maximum performance. Your device displays heat and altitude corrected VO2 max. values when you are acclimating to high heat environments or high altitude.

**Training load:** Training load is the sum of your excess post-exercise oxygen consumption (EPOC) over the last 7 days. EPOC is an estimate of how much energy it takes for your body to recover after exercise.

**Training load focus:** Your device analyzes and distributes your training load into different categories based on the intensity and structure of each activity recorded. Training load focus includes the total load accumulated per category, and the focus of the training. Your device displays your load distribution over the last 4 weeks.

**Recovery time:** The recovery time displays how much time remains before you are fully recovered and ready for the next hard workout.

## Training Status Levels

Training status shows you how your training affects your fitness level and performance. Your training status is based on changes to your training load and VO2 max. over an extended time period. You can use your training status to help plan future training and continue improving your fitness level.

**Peaking:** Peaking means that you are in ideal race condition. Your recently reduced training load is allowing your body to recover and fully compensate for earlier training. You should plan ahead, since this peak state can only be maintained for a short time.

**Productive:** Your current training load is moving your fitness level and performance in the right direction. You should plan recovery periods into your training to maintain your fitness level.

**Maintaining:** Your current training load is enough to maintain your fitness level. To see improvement, try adding more variety to your workouts or increasing your training volume.

**Recovery:** Your lighter training load is allowing your body to recover, which is essential during extended periods of hard training. You can return to a higher training load when you feel ready.

**Unproductive:** Your training load is at a good level, but your fitness is decreasing. Your body may be struggling to recover, so you should pay attention to your overall health including stress, nutrition, and rest.

**Detraining:** Detraining occurs when you are training much less than usual for a week or more, and it is affecting your fitness level. You can try increasing your training load to see improvement.

**Overreaching:** Your training load is very high and counterproductive. Your body needs a rest. You should give yourself time to recover by adding lighter training to your schedule.

**No Status:** The device needs one or two weeks of training history, including activities with VO2 max. results from running or cycling, to determine your training status.

## Tips for Getting Your Training Status

The training status feature depends on updated assessments of your fitness level, including at least two VO2 max. measurements per week. Your VO2 max. estimate is updated after outdoor runs or rides with power during which your heart rate reached at least 70% of your maximum heart rate for several minutes. Indoor run activities do not generate a VO2 max. estimate in order to preserve the accuracy of your fitness level trend. You can disable VO2 max. recording for ultra run and trail run activities if you do not want those run types to affect your VO2 max. estimate ([Turning Off VO2 Max. Recording, page 47](#)).

To get the most out of the training status feature, you can try these tips.

- At least two times per week, run or ride outdoors with a power meter, and reach a heart rate higher than 70% of your maximum heart rate for at least 10 minutes.  
After using the device for one week, your training status should be available.
- Record all of your fitness activities on this device, or enable the Physio TrueUp feature, allowing your device to learn about your performance ([Syncing Activities and Performance Measurements, page 45](#)).

## Heat and Altitude Performance Acclimation

Environmental factors such as high temperature and altitude impact your training and performance. For example, high altitude training can have a positive impact on your fitness, but you may notice a temporary VO2 max. decline while exposed to high altitudes. Your MARQ device provides acclimation notifications and corrections to your VO2 max. estimate and training status when the temperature is above 22°C (72°F) and when the altitude is above 800 m (2625 ft.). You can keep track of your heat and altitude acclimation in the training status widget.

**NOTE:** The heat acclimation feature is available only for GPS activities and requires weather data from your connected smartphone.

## Training Load

Training load is a measurement of your training volume over the last seven days. It is the sum of your excess post-exercise oxygen consumption (EPOC) measurements for the last seven days. The gauge indicates whether your current load is low, high, or within the optimal range to maintain or improve your fitness level. The optimal range is determined based on your individual fitness level and training history. The range adjusts as your training time and intensity increase or decrease.

## Training Load Focus

In order to maximize performance and fitness gains, training should be distributed across three categories: low aerobic, high aerobic, and anaerobic. Training load focus shows you how much of your training is currently in each category and provides training targets. Training load focus requires at least 7 days of training to determine if your training load is low, optimal, or high. After 4 weeks of training history, your training load estimate will have more detailed target information to help you balance your training activities.

**Below targets:** Your training load is lower than optimal in all intensity categories. Try increasing the duration or frequency of your workouts.

**Low aerobic shortage:** Try adding more low aerobic activities to provide recovery and balance for your higher intensity activities.

**High aerobic shortage:** Try adding more high aerobic activities to help improve your lactate threshold and VO2 max. over time.

**Anaerobic shortage:** Try adding a few more intense, anaerobic activities to improve your speed and anaerobic capacity over time.

**Balanced:** Your training load is balanced and provides all-around fitness benefits as you continue training.

**Low aerobic focus:** Your training load is mostly low aerobic activity. This provides a solid foundation and prepares you for adding more intense workouts.

**High aerobic focus:** Your training load is mostly high aerobic activity. These activities help to improve lactate threshold, VO2 max., and endurance.

**Anaerobic focus:** Your training load is mostly intense activity. This leads to rapid fitness gains, but should be balanced with low aerobic activities.

**Above targets:** Your training load is higher than optimal, and you should consider scaling back the duration and frequency of your workouts.

## Recovery Time

You can use your Garmin device with wrist-based heart rate or a compatible chest heart rate monitor to display how much time remains before you are fully recovered and ready for the next hard workout.

**NOTE:** The recovery time recommendation uses your VO2 max. estimate and may seem inaccurate at first. The device requires you to complete a few activities to learn about your performance.

The recovery time appears immediately following an activity. The time counts down until it is optimal for you to attempt another hard workout. The device updates your recovery time throughout the day based on changes in sleep, stress, relaxation, and physical activity.

## Viewing Your Recovery Time

For the most accurate estimate, complete the user profile setup ([Setting Up Your User Profile, page 56](#)), and set your maximum heart rate ([Setting Your Heart Rate Zones, page 57](#)).

1 Go for a run.

2 After your run, select **Save**.

The recovery time appears. The maximum time is 4 days.

**NOTE:** From the watch face, you can select UP or DOWN to view the training status widget, and select START to scroll through the metrics to view your recovery time.

## Recovery Heart Rate

If you are training with wrist-based heart rate or a compatible chest heart rate monitor, you can check your recovery heart rate value after each activity. Recovery heart rate is the difference between your exercising heart rate and your heart rate two minutes after the exercise has stopped. For example, after a typical training run, you stop the timer. Your heart rate is 140 bpm. After two minutes of no activity or cool down, your heart rate is 90 bpm. Your recovery heart rate is 50 bpm (140 minus 90). Some studies have linked recovery heart rate to cardiac health. Higher numbers generally indicate healthier hearts.

**TIP:** For best results, you should stop moving for two minutes while the device calculates your recovery heart rate value.

## Body Battery™

Your device analyzes your heart rate variability, stress level, sleep quality, and activity data to determine your overall Body Battery level. Like a gas gauge on a car, it indicates your amount of available reserve energy. The Body Battery level range is from 0 to 100, where 0 to 25 is low reserve energy, 26 to 50 is medium reserve energy, 51 to 75 is high reserve energy, and 76 to 100 is very high reserve energy.

You can sync your device with your Garmin Connect account to view your most up-to-date Body Battery level, long-term trends, and additional details ([Tips for Improved Body Battery Data, page 54](#)).

### Viewing the Body Battery Widget

The Body Battery widget displays your current Body Battery level and a graph of your Body Battery level for the last several hours.

1 Press **UP** or **DOWN** to view the Body Battery widget.

**NOTE:** You may need to add the widget to your widget loop ([Customizing the Widget Loop, page 93](#)).

2 Press **START** to view a graph of your body battery level since midnight.

3 Press **DOWN** to view a combined graph of your Body Battery and stress levels.

Blue bars indicate periods of rest. Orange bars indicate periods of stress. Gray bars indicate times when you were too active to determine your stress level.

### Tips for Improved Body Battery Data

- For more accurate results, wear the device while sleeping.
- Good sleep charges your Body Battery.
- Strenuous activity and high stress can cause your Body Battery to drain more quickly.
- Food intake, as well as stimulants like caffeine, has no impact on your Body Battery.

# Pulse Oximeter

The MARQ device has a wrist-based pulse oximeter to gauge the saturation of oxygen in your blood (SpO2). Knowing your oxygen saturation can help you determine how your body is adjusting to high altitudes. As your altitude increases, the level of oxygen in your blood can decrease. When you view the pulse oximeter widget while you are not moving, your device analyzes your oxygen saturation and your elevation. The elevation profile helps indicate how your pulse oximeter readings are changing, relative to your to elevation. During a flight, the device automatically takes pulse oximeter readings more frequently, so you can monitor your SpO2 percentage ([Viewing Your SpO2 Readings in Flight, page 6](#)).

On the device, your pulse oximeter reading appears as an oxygen saturation percentage and color on the graph. On your Garmin Connect account, you can view additional details about your pulse oximeter readings, including trends over multiple days.

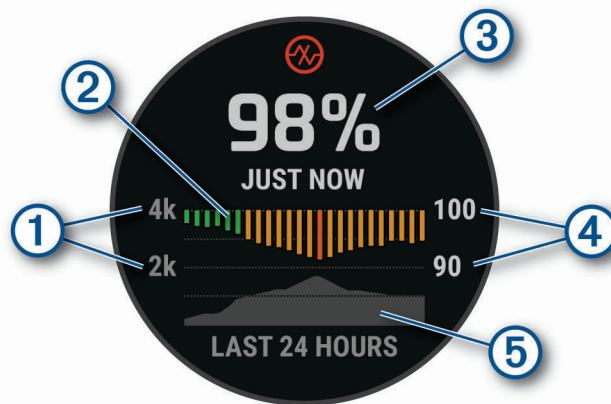

- |   |   |
|---|---|
| ① | The elevation scale.  |
| ② | A graph of your average oxygen saturation readings for the last 24 hours. |
| ③ | Your most recent oxygen saturation reading.                               |
| ④ | The oxygen saturation percentage scale.                                   |
| ⑤ | A graph of your elevation readings for the last 24 hours.                 |

## Getting Pulse Oximeter Readings

You can manually begin a pulse oximeter reading by viewing the pulse oximeter widget. The widget displays your most recent blood oxygen saturation percentage, a graph of your hourly average readings for the last 24 hours, and a graph of your elevation for the last 24 hours.

**NOTE:** The first time you view the pulse oximeter widget, the device must acquire satellite signals to determine your elevation. You should go outside, and wait while the device locates satellites.

- 1 While you are sitting or inactive, press **UP** or **DOWN** to view the pulse oximeter widget.
- 2 Press **START** to view widget details and begin a pulse oximeter reading.
- 3 Remain motionless for up to 30 seconds.

**NOTE:** If you are too active for the watch to get a pulse oximeter reading, a message appears instead of a percentage. You can check again after several minutes of inactivity. For best results, hold the arm wearing the device at heart level while the device reads your blood oxygen saturation.

- 4 Press **DOWN** to view a graph of your pulse oximeter readings for the last seven days.

## Turning On All-Day Pulse Oximeter Readings

1 From the pulse oximeter widget, hold **MENU**.

2 Select **Options > Pulse Ox Mode > All Day**.

The device automatically analyzes your oxygen saturation throughout the day, when you are not moving.

**NOTE:** Turning on all-day mode decreases battery life.

## Turning Off Automatic Pulse Oximeter Readings

1 From the pulse oximeter widget, hold **MENU**.

2 Select **Options > Pulse Ox Mode > Off**.

The device turns off automatic pulse oximeter readings. The device begins a pulse oximeter reading when you view the pulse oximeter widget.

## Turning On Pulse Oximeter Sleep Tracking

You can set your device to continuously measure your blood oxygen saturation while you sleep.

**NOTE:** Unusual sleep positions can cause abnormally low sleep-time SpO2 readings.

1 From the pulse oximeter widget, hold **MENU**.

2 Select **Options > Pulse Ox Mode > During Sleep**.

## Tips for Erratic Pulse Oximeter Data

If the pulse oximeter data is erratic or does not appear, you can try these tips.

- Remain motionless while the device reads your blood oxygen saturation.
- Wear the device above your wrist bone. The device should be snug but comfortable.
- Hold the arm wearing the device at heart level while the device reads your blood oxygen saturation.
- Use a silicone band or an UltraFit nylon strap.
- Clean and dry your arm before putting on the device.
- Avoid wearing sunscreen, lotion, and insect repellent under the device.
- Avoid scratching the optical sensor on the back of the device.
- Rinse the device with fresh water after each workout.

# Training

## Setting Up Your User Profile

You can update your gender, birth year, height, weight, heart rate zone, and power zone settings. The device uses this information to calculate accurate training data.

1 Hold **MENU**.

2 Select **User Profile**.

3 Select an option.

## Fitness Goals

Knowing your heart rate zones can help you measure and improve your fitness by understanding and applying these principles.

- Your heart rate is a good measure of exercise intensity.
- Training in certain heart rate zones can help you improve cardiovascular capacity and strength.

If you know your maximum heart rate, you can use the table ([Heart Rate Zone Calculations, page 58](#)) to determine the best heart rate zone for your fitness objectives.

If you do not know your maximum heart rate, use one of the calculators available on the Internet. Some gyms and health centers can provide a test that measures maximum heart rate. The default maximum heart rate is 220 minus your age.

## About Heart Rate Zones

Many athletes use heart rate zones to measure and increase their cardiovascular strength and improve their level of fitness. A heart rate zone is a set range of heartbeats per minute. The five commonly accepted heart rate zones are numbered from 1 to 5 according to increasing intensity. Generally, heart rate zones are calculated based on percentages of your maximum heart rate.

## Setting Your Heart Rate Zones

The device uses your user profile information from the initial setup to determine your default heart rate zones. You can set separate heart rate zones for sport profiles, such as running, cycling, and swimming. For the most accurate calorie data during your activity, set your maximum heart rate. You can also set each heart rate zone and enter your resting heart rate manually. You can manually adjust your zones on the device or using your Garmin Connect account.

- 1 Hold **MENU**.
- 2 Select **User Profile > Heart Rate**.
- 3 Select **Max. HR**, and enter your maximum heart rate.  
You can use the Auto Detection feature to automatically record your maximum heart rate during an activity ([Detecting Performance Measurements Automatically, page 45](#)).
- 4 Select **LTHR > Enter Manually**, and enter your lactate threshold heart rate.  
You can perform a guided test to estimate your lactate threshold ([Lactate Threshold, page 49](#)). You can use the Auto Detection feature to automatically record your lactate threshold during an activity ([Detecting Performance Measurements Automatically, page 45](#)).
- 5 Select **Resting HR**, and enter your resting heart rate.  
You can use the average resting heart rate measured by your device, or you can set a custom resting heart rate.
- 6 Select **Zones > Based On**.
- 7 Select an option:
  - Select **BPM** to view and edit the zones in beats per minute.
  - Select **%Max. HR** to view and edit the zones as a percentage of your maximum heart rate.
  - Select **%HRR** to view and edit the zones as a percentage of your heart rate reserve (maximum heart rate minus resting heart rate).
  - Select **%LTHR** to view and edit the zones as a percentage of your lactate threshold heart rate.
- 8 Select a zone, and enter a value for each zone.
- 9 Select **Add Sport Heart Rate**, and select a sport profile to add separate heart rate zones (optional).
- 10 Repeat the steps to add sport heart rate zones (optional).



## Letting the Device Set Your Heart Rate Zones

The default settings allow the device to detect your maximum heart rate and set your heart rate zones as a percentage of your maximum heart rate.

- Verify that your user profile settings are accurate ([Setting Up Your User Profile, page 56](#)).
- Run often with the wrist or chest heart rate monitor.
- Try a few heart rate training plans, available from your Garmin Connect account.
- View your heart rate trends and time in zones using your Garmin Connect account.

## Heart Rate Zone Calculations

Zone	% of Maximum Heart Rate	Perceived Exertion	Benefits
1	50–60%	Relaxed, easy pace, rhythmic breathing	Beginning-level aerobic training, reduces stress
2	60–70%	Comfortable pace, slightly deeper breathing, conversation possible	Basic cardiovascular training, good recovery pace
3	70–80%	Moderate pace, more difficult to hold conversation	Improved aerobic capacity, optimal cardiovascular training
4	80–90%	Fast pace and a bit uncomfortable, breathing forceful	Improved anaerobic capacity and threshold, improved speed
5	90–100%	Sprinting pace, unsustainable for long period of time, labored breathing	Anaerobic and muscular endurance, increased power

## Setting Your Power Zones

The values for the zones are default values based on gender, weight, and average ability, and may not match your personal abilities. If you know your functional threshold power (FTP) value, you can enter it and allow the software to calculate your power zones automatically. You can manually adjust your zones on the device or using your Garmin Connect account.

- 1 Hold **MENU**.
- 2 Select **User Profile > Power Zones**.
- 3 Select an activity.
- 4 Select **Based On**.
- 5 Select an option:
  - Select **Watts** to view and edit the zones in watts.
  - Select **% FTP** to view and edit the zones as a percentage of your functional threshold power.
- 6 Select **FTP**, and enter your FTP value.
- 7 Select a zone, and enter a value for each zone.
- 8 If necessary, select **Minimum**, and enter a minimum power value.

## Activity Tracking

The activity tracking feature records your daily step count, distance traveled, intensity minutes, floors climbed, calories burned, and sleep statistics for each recorded day. Your calories burned includes your base metabolism plus activity calories.

The number of steps taken during the day appears on the steps widget. The step count is updated periodically.

For more information about activity tracking and fitness metric accuracy, go to [garmin.com/ataccuracy](https://garmin.com/ataccuracy).



## Auto Goal

Your device creates a daily step goal automatically, based on your previous activity levels. As you move during the day, the device shows your progress toward your daily goal ①.

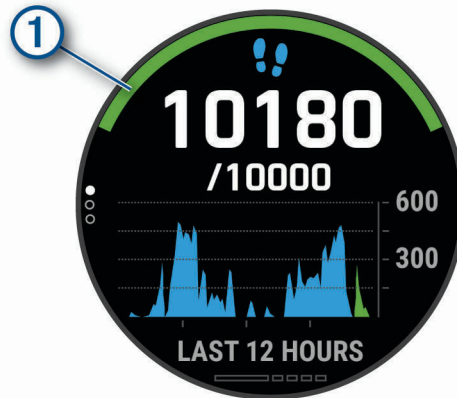

If you choose not to use the auto goal feature, you can set a personalized step goal on your Garmin Connect account.

## Using the Move Alert

Sitting for prolonged periods of time can trigger undesirable metabolic state changes. The move alert reminds you to keep moving. After one hour of inactivity, Move! and the red bar appear. Additional segments appear after every 15 minutes of inactivity. The device also beeps or vibrates if audible tones are turned on ([System Settings](#), page 103).

Go for a short walk (at least a couple of minutes) to reset the move alert.

## Sleep Tracking

While you are sleeping, the device automatically detects your sleep and monitors your movement during your normal sleep hours. You can set your normal sleep hours in the user settings on your Garmin Connect account. Sleep statistics include total hours of sleep, sleep stages, and sleep movement. You can view your sleep statistics on your Garmin Connect account.

**NOTE:** Naps are not added to your sleep statistics. You can use do not disturb mode to turn off notifications and alerts, with the exception of alarms ([Using Do Not Disturb Mode](#), page 59).

## Using Automated Sleep Tracking

- 1 Wear your device while sleeping.
- 2 Upload your sleep tracking data to the Garmin Connect site ([Manually Syncing Data with Garmin Connect](#), page 31).

You can view your sleep statistics on your Garmin Connect account.

## Using Do Not Disturb Mode

You can use do not disturb mode to turn off the backlight, tone alerts, and vibration alerts. For example, you can use this mode while sleeping or watching a movie.

**NOTE:** You can set your normal sleep hours in the user settings on your Garmin Connect account. You can enable the During Sleep option in the system settings to automatically enter do not disturb mode during your normal sleep hours ([System Settings](#), page 103).

**NOTE:** You can add options to the controls menu ([Customizing the Controls Menu](#), page 97).

- 1 Hold **LIGHT**.
- 2 Select .

## Intensity Minutes

To improve your health, organizations such as the World Health Organization recommend at least 150 minutes per week of moderate intensity activity, such as brisk walking, or 75 minutes per week of vigorous intensity activity, such as running.

The device monitors your activity intensity and tracks your time spent participating in moderate to vigorous intensity activities (heart rate data is required to quantify vigorous intensity). The device adds the amount of moderate activity minutes with the amount of vigorous activity minutes. Your total vigorous intensity minutes are doubled when added.

## Earning Intensity Minutes

Your MARQ device calculates intensity minutes by comparing your heart rate data to your average resting heart rate. If heart rate is turned off, the device calculates moderate intensity minutes by analyzing your steps per minute.

- Start a timed activity for the most accurate calculation of intensity minutes.
- Wear your device all day and night for the most accurate resting heart rate.

## Garmin Move IQ™

When your movements match familiar exercise patterns, the Move IQ feature automatically detects the event and displays it in your timeline. The Move IQ events show activity type and duration, but they do not appear in your activities list or newsfeed. For more detail and accuracy, you can record a timed activity on your device.

## Activity Tracking Settings

Hold **MENU**, and select **Activity Tracking**.

**Status:** Turns off the activity tracking features.

**Move Alert:** Displays a message and the move bar on the digital watch face and steps screen. The device also beeps or vibrates if audible tones are turned on ([System Settings, page 103](#)).

**Goal Alerts:** Allows you to turn on and off goal alerts, or turn them off only during activities. Goal alerts appear for your daily steps goal, daily floors climbed goal, and weekly intensity minutes goal.

**Move IQ:** Allows you to turn on and off Move IQ events.

**Pulse Ox Mode:** Sets your device to record pulse oximeter readings while you are inactive during the day or continuously while you sleep.

## Turning Off Activity Tracking

When you turn off activity tracking, your steps, floors climbed, intensity minutes, sleep tracking, and Move IQ events are not recorded.

- 1 Hold **MENU**.
- 2 Select **Activity Tracking > Status > Off**.

## Workouts

You can create custom workouts that include goals for each workout step and for varied distances, times, and calories. During your activity, you can view workout-specific data screens that contain workout step information, such as the workout step distance or average step pace.

Your device includes several preloaded workouts for multiple activities. You can create and find more workouts using Garmin Connect, or select a training plan that has built-in workouts and transfer them to your device.

You can schedule workouts using Garmin Connect. You can plan workouts in advance and store them on your device.



## Following a Workout From Garmin Connect

Before you can download a workout from Garmin Connect, you must have a Garmin Connect account ([Garmin Connect, page 30](#)).

- 1 Select an option:
  - Open the Garmin Connect app.
  - Go to [connect.garmin.com](https://connect.garmin.com).
- 2 Select **Training** > **Workouts**.
- 3 Find a workout, or create and save a new workout.
- 4 Select  or **Send to Device**.
- 5 Follow the on-screen instructions.

## Creating a Custom Workout on Garmin Connect

Before you can create a workout on the Garmin Connect app, you must have a Garmin Connect account ([Garmin Connect, page 30](#)).



- 1 From the Garmin Connect app, select  or .
- 2 Select **Training** > **Workouts** > **Create a Workout**.
- 3 Select an activity.
- 4 Create your custom workout.
- 5 Select **Save**.
- 6 Enter a name for your workout, and select **Save**.

The new workout appears in your list of workouts.

**NOTE:** You can send this workout to your device ([Sending a Custom Workout to Your Device, page 61](#)).

## Sending a Custom Workout to Your Device

You can send a custom workout you created with the Garmin Connect app to your device ([Creating a Custom Workout on Garmin Connect, page 61](#)).

- 1 From the Garmin Connect app, select  or .
- 2 Select **Training** > **Workouts**.
- 3 Select a workout from the list.
- 4 Select .
- 5 Select your compatible device.
- 6 Follow the on-screen instructions.

## Starting a Workout

Your device can guide you through multiple steps in a workout.

1 From the watch face, press **START**.

2 Select an activity.

3 Hold **MENU**.

4 Select **Training > Workouts**.

5 Select a workout.

**NOTE:** Only workouts that are compatible with the selected activity appear in the list.

6 Select **View** to view a list of workout steps (optional).

**TIP:** While viewing workout steps, you can press **START** to view an animation of the selected exercise, if available.

7 Select **Do Workout**.

8 Press **START** to start the activity timer.

After you begin a workout, the device displays each step of the workout, step notes (optional), the target (optional), and the current workout data. For strength, yoga, cardio, or Pilates activities, an instructional animation appears.

## Following a Daily Suggested Workout

Before the device can suggest a daily workout, you must have a training status and VO2 max. estimate ([Training Status, page 51](#)).

1 From the watch face, select **START**.

2 Select **Run** or **Bike**.

The daily suggested workout appears.

3 Select **START**, and select an option:

- To do the workout, select **Do Workout**.
- To discard the workout, select **Dismiss**.
- To preview the workout steps, select **Steps**.
- To update the workout target setting, select **Target Type**.
- To turn off future workout notifications, select **Disable Prompt**.

The suggested workout updates automatically to changes in training habits, recovery time, and VO2 max.

## Turning Daily Suggested Workout Prompts On and Off

Daily suggested workouts are recommended based on your previous activities saved to your Garmin Connect account.

1 From the watch face, select **START**.

2 Select **Run** or **Bike**.

3 Hold **MENU**.

4 Select **Training > Workouts > Today's Suggestion**.

5 Select **START** to disable or enable prompts.

## Following a Pool Swim Workout

Your device can guide you through multiple steps in a swim workout. Creating and sending a pool swim workout is similar to [Workouts, page 60](#) and [Following a Workout From Garmin Connect, page 61](#).

1 From the watch face, select **START > Pool Swim > Options > Training**.

2 Select an option:

- Select **Workouts** to do workouts downloaded from Garmin Connect.
- Select **Training Calendar** to do or view your scheduled workouts.

3 Follow the on-screen instructions.

## Recording a Critical Swim Speed Test

Your Critical Swim Speed (CSS) value is the result of a time-trial-based test. Your CSS is the theoretical speed you can maintain continuously without exhaustion. You can use your CSS to guide your training pace and monitor your improvement.

- 1 From the watch face, press **START**.
- 2 Select **Pool Swim**.
- 3 Hold **MENU**.
- 4 Select **Training > Critical Swim Speed > Do Critical Swim Speed Test**.
- 5 Press **DOWN** to preview the workout steps.
- 6 Select **OK**.
- 7 Press **START**.
- 8 Follow the on-screen instructions.

## Editing Your Critical Swim Speed Result

You can manually edit or enter a new time for your CSS value.



- 1 From the watch face, press **START**.
- 2 Select **Pool Swim**.
- 3 Hold **MENU**.
- 4 Select **Training > Critical Swim Speed > Critical Swim Speed**.
- 5 Enter the minutes.
- 6 Enter the seconds.

## About the Training Calendar

The training calendar on your device is an extension of the training calendar or schedule you set up in Garmin Connect. After you have added a few workouts to the Garmin Connect calendar, you can send them to your device. All scheduled workouts sent to the device appear in the calendar widget. When you select a day in the calendar, you can view or do the workout. The scheduled workout stays on your device whether you complete it or skip it. When you send scheduled workouts from Garmin Connect, they overwrite the existing training calendar.

## Using Garmin Connect Training Plans

Before you can download and use a training plan from Garmin Connect, you must have a Garmin Connect account ([Garmin Connect, page 30](#)), and you must pair the MARQ device with a compatible smartphone.

- 1 From the Garmin Connect app, select  or .
- 2 Select **Training > Training Plans**.
- 3 Select and schedule a training plan.
- 4 Follow the on-screen instructions.
- 5 Review the training plan in your calendar.

## Adaptive Training Plans

Your Garmin Connect account has an adaptive training plan and Garmin coach to fit your training goals. For example, you can answer a few questions and find a plan to help you complete a 5 km race. The plan adjusts to your current level of fitness, coaching and schedule preferences, and race date. When you start a plan, the Garmin Coach widget is added to the widget loop on your MARQ device.

## Starting Today's Workout

After you send a Garmin Coach training plan to your device, the Garmin Coach widget appears in your widget loop.

- 1 From the watch face, select **UP** or **DOWN** to view the Garmin Coach widget.  
If a workout for this activity is scheduled for today, the device shows the workout name and prompts you to start it.
- 2 Select **START**.
- 3 Select **View** to view the workout steps (optional).
- 4 Select **Do Workout**.
- 5 Follow the on-screen instructions.

## Interval Workouts

You can create interval workouts based on distance or time. The device saves your custom interval workout until you create another interval workout. You can use open intervals for track workouts and when you are running a known distance.

### Creating an Interval Workout

- 1 From the watch face, press **START**.
- 2 Select an activity.
- 3 Hold **MENU**.
- 4 Select **Training > Intervals > Edit > Interval > Type**.
- 5 Select **Distance, Time, or Open**.  
**TIP:** You can create an open-ended interval by selecting the Open option.
- 6 If necessary, select **Duration**, enter a distance or time interval value for the workout, and select **✓**.
- 7 Press **BACK**.
- 8 Select **Rest > Type**.
- 9 Select **Distance, Time, or Open**.
- 10 If necessary, enter a distance or time value for the rest interval, and select **✓**.
- 11 Press **BACK**.
- 12 Select one or more options:
  - To set the number of repetitions, select **Repeat**.
  - To add an open-ended warm up to your workout, select **Warm Up > On**.
  - To add an open-ended cool down to your workout, select **Cool Down > On**.

### Starting an Interval Workout

- 1 From the watch face, press **START**.
- 2 Select an activity.
- 3 Hold **MENU**.
- 4 Select **Training > Intervals > Do Workout**.
- 5 Press **START** to start the activity timer.
- 6 When your interval workout has a warm up, press **LAP** to begin the first interval.
- 7 Follow the on-screen instructions.

After you complete all of the intervals, a message appears.

## Stopping an Interval Workout

- At any time, select **LAP** to stop the current interval or rest period and transition to the next interval or rest period.
- After all intervals and rest periods are complete, select **LAP** to end the interval workout and transition to a timer that can be used for cool down.
- At any time, select **STOP** to stop the activity timer. You can resume the timer or end the interval workout.



## PacePro Training

Many runners like to wear a pace band during a race to help achieve their race goal. The PacePro feature allows you to create a custom pace band based on distance and pace or distance and time. You can also create a pace band for a known course to optimize your pace effort based on elevation changes.

You can create a PacePro plan using the Garmin Connect app. You can preview the splits and elevation plot before you run the course.

## Downloading a PacePro Plan from Garmin Connect

Before you can download a PacePro plan from Garmin Connect, you must have a Garmin Connect account ([Garmin Connect](#), page 30).

- 1 Select an option:
  - Open the Garmin Connect app, and select  or .
  - Go to [connect.garmin.com](https://connect.garmin.com).
- 2 Select **Training** > **PacePro Pacing Strategies**.
- 3 Follow the on-screen instructions to create and save a PacePro plan.
- 4 Select  or **Send to Device**.

## Starting a PacePro Plan

Before you can start a PacePro plan, you must download a plan from your Garmin Connect account.

- 1 From the watch face, press **START**.
- 2 Select an outdoor running activity.
- 3 Hold **MENU**.
- 4 Select **Training > PacePro Plans**.
- 5 Select a plan.  
**TIP:** You can press **DOWN** and select **View Splits** to preview the splits.
- 6 Press **START** to start the plan.
- 7 If necessary, select **Yes** to enable course navigation.
- 8 Press **START** to start the activity timer.

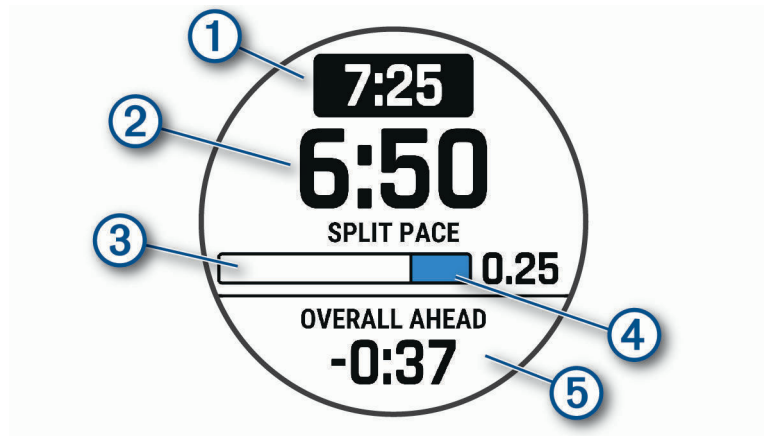

①	Target split pace
②	Current split pace
③	Completion progress for the split
④	Distance remaining in the split
⑤	Overall time ahead of or behind your target time

## Stopping a PacePro Plan

- 1 Hold **MENU**.
- 2 Select **Stop PacePro > Yes**.  
The device stops the PacePro plan. The activity timer continues running.

## Creating a PacePro Plan on Your Watch

Before you can create a PacePro plan on your watch, you must create a course (*Creating and Following a Course on Your Device*, page 74).

- 1 From the watch face, select **START**.
- 2 Select an outdoor running activity.
- 3 Hold **MENU**.
- 4 Select **Navigation > Courses**.
- 5 Select a course.
- 6 Select **PacePro > Create New**.
- 7 Select an option:
  - Select **Goal Pace**, and enter your target pace.
  - Select **Goal Time**, and enter your target time.The device displays your custom pace band.

**TIP:** You can press **DOWN** and select **View Splits** to preview the splits.
- 8 Select **START** to start the plan.
- 9 If necessary, select **Yes** to enable course navigation.
- 10 Select **START** to start the activity timer.

## Segments

You can send running or cycling segments from your Garmin Connect account to your device. After a segment is saved to your device, you can race a segment, trying to match or exceed your personal record or other participants who have raced the segment.

**NOTE:** When you download a course from your Garmin Connect account, you can download all of the available segments in the course.

### Strava™ Segments

You can download Strava segments to your MARQ device. Follow Strava segments to compare your performance with your past rides, friends, and pros who have ridden the same segment.

To sign up for a Strava membership, go to the segments widget in your Garmin Connect account. For more information, go to [www.strava.com](http://www.strava.com).

The information in this manual applies to both Garmin Connect segments and Strava segments.

## Viewing Segment Details

- 1 From the watch face, press **START**.
- 2 Select an activity.
- 3 Hold **MENU**.
- 4 Select **Training > Segments**.
- 5 Select a segment.
- 6 Select an option:
  - Select **Race Time** to view the time and average speed or pace for the segment leader.
  - Select **Map** to view the segment on the map.
  - Select **Elevation Plot** to view an elevation plot of the segment.

## Racing a Segment

Segments are virtual race courses. You can race a segment, and compare your performance to past activities, others' performance, connections in your Garmin Connect account, or other members of the running or cycling communities. You can upload your activity data to your Garmin Connect account to view your segment position.

**NOTE:** If your Garmin Connect account and Strava account are linked, your activity is automatically sent to your Strava account so you can review the segment position.

- 1 From the watch face, press **START**.
- 2 Select an activity.
- 3 Go for a run or ride.

When you approach a segment, a message appears, and you can race the segment.

- 4 Start racing the segment.

A message appears when the segment is complete.

## Setting a Segment to Adjust Automatically

You can set your device to automatically adjust the target race time of a segment based on your performance during the segment.

**NOTE:** This setting is enabled for all segments by default.

- 1 From the watch face, press **START**.
- 2 Select an activity.
- 3 Hold **MENU**.
- 4 Select **Training > Segments > Auto Effort**.

## Using Virtual Partner\*

Your Virtual Partner is a training tool designed to help you meet your goals. You can set a pace for the Virtual Partner and race against it.

**NOTE:** This feature is not available for all activities.

- 1 Hold **MENU**.
- 2 Select **Activities & Apps**.
- 3 Select an activity.
- 4 Select the activity settings.
- 5 Select **Data Screens > Add New > Virtual Partner**.
- 6 Enter a pace or speed value.
- 7 Press **UP** or **DOWN** to change the location of the Virtual Partner screen (optional).
- 8 Start your activity ([Starting an Activity, page 11](#)).
- 9 Press **UP** or **DOWN** to scroll to the Virtual Partner screen and see who is leading.

## Setting a Training Target

The training target feature works with the Virtual Partner feature so you can train toward a set distance, distance and time, distance and pace, or distance and speed goal. During your training activity, the device gives you real-time feedback about how close you are to achieving your training target.

- 1 From the watch face, press **START**.
- 2 Select an activity.
- 3 Hold **MENU**.
- 4 Select **Training > Set a Target**.
- 5 Select an option:
  - Select **Distance Only** to select a preset distance or enter a custom distance.
  - Select **Distance and Time** to select a distance and time target.
  - Select **Distance and Pace** or **Distance and Speed** to select a distance and pace or speed target.

The training target screen appears and displays your estimated finish time. The estimated finish time is based on your current performance and the time remaining.

- 6 Press **START** to start the activity timer.

## Cancelling a Training Target

- 1 During an activity, hold **MENU**.
- 2 Select **Cancel Target > Yes**.

## Racing a Previous Activity

You can race a previously recorded or downloaded activity. This feature works with the Virtual Partner feature so you can see how far ahead or behind you are during the activity.

**NOTE:** This feature is not available for all activities.

- 1 From the watch face, press **START**.
- 2 Select an activity.
- 3 Hold **MENU**.
- 4 Select **Training > Race an Activity**.
- 5 Select an option:
  - Select **From History** to select a previously recorded activity from your device.
  - Select **Downloaded** to select an activity you downloaded from your Garmin Connect account.

- 6 Select the activity.

The Virtual Partner screen appears indicating your estimated finish time.

- 7 Press **START** to start the activity timer.
- 8 After you complete your activity, press **STOP**, and select **Save**.

## Personal Records

When you complete an activity, the device displays any new personal records you achieved during that activity. Personal records include your fastest time over several typical race distances and longest run, ride, or swim.

**NOTE:** For cycling, personal records also include most ascent and best power (power meter required).

## Viewing Your Personal Records

- 1 From the watch face, hold **MENU**.
- 2 Select **History > Records**.
- 3 Select a sport.
- 4 Select a record.
- 5 Select **View Record**.

## Restoring a Personal Record

You can set each personal record back to the one previously recorded.

- 1 From the watch face, hold **MENU**.
- 2 Select **History > Records**.
- 3 Select a sport.
- 4 Select a record to restore.
- 5 Select **Previous > Yes**.

**NOTE:** This does not delete any saved activities.

## Clearing a Personal Record

- 1 From the watch face, hold **MENU**.
- 2 Select **History > Records**.
- 3 Select a sport.
- 4 Select a record to delete.
- 5 Select **Clear Record > Yes**.

**NOTE:** This does not delete any saved activities.

## Clearing All Personal Records

- 1 From the watch face, hold **MENU**.
- 2 Select **History > Records**.
- 3 Select a sport.
- 4 Select **Clear All Records > Yes**.

The records are deleted for that sport only.

**NOTE:** This does not delete any saved activities.

## Pausing Your Training Status

If you are injured or sick, you can pause your training status. You can continue to record fitness activities, but your training status, training load focus, recovery feedback, and workout recommendations are temporarily disabled.

Select an option:

- From the training status widget, hold **MENU**, and select **Options > Pause Training Status**.
- From your Garmin Connect settings, select **Performance Stats > Training Status > ⋮ > Pause Training Status**.

**TIP:** You should sync your device with your Garmin Connect account.

## Resuming Your Paused Training Status

You can resume your training status when you are ready to start training again. For best results, you need at least two VO2 max. measurements each week ([About VO2 Max. Estimates, page 46](#)).

Select an option:

- From the training status widget, hold **MENU**, and select **Options > Resume Training Status**.
- From your Garmin Connect settings, select **Performance Stats > Training Status > ⋮ > Resume Training Status**.

**TIP:** You should sync your device with your Garmin Connect account.

## Enabling Self Evaluation

When you save an activity, you can evaluate your perceived effort and how you felt during the activity. Your self evaluation information can be viewed in your Garmin Golf account.

- 1 Hold **MENU**.
- 2 Select **Activities & Apps**.
- 3 Select an activity.
- 4 Select the activity settings.
- 5 Select **Self Evaluation**.
- 6 Select an option:
  - To complete self evaluation only after workouts, select **Workouts Only**.
  - To complete self evaluation after every activity, select **Always**.

## Clocks

### Setting an Alarm

You can set multiple alarms.

- 1 From the watch face, hold **MENU**.
- 2 Select **Clocks > ALARMS > Add Alarm**.
- 3 Enter the alarm time.

### Editing an Alarm

- 1 From the watch face, hold **MENU**.
- 2 Select **Clocks > ALARMS > Edit**.
- 3 Select an alarm.
- 4 Select an option:
  - To turn the alarm on or off, select **Status**.
  - To change the alarm time, select **Time**.
  - To set the alarm to repeat regularly, select **Repeat**, and select when the alarm should repeat.
  - To select the type of alarm notification, select **Sounds**.
  - To turn the backlight on or off with the alarm, select **Backlight**.
  - To select a description for the alarm, select **Label**.
  - To delete the alarm, select **Delete**.

### Starting the Countdown Timer

- 1 From the watch face, hold **MENU**.
- 2 Select **Clocks > TIMERS**.
- 3 Select an option:
  - To set and save a countdown timer for the first time, enter the time, press **MENU**, and select **Save Timer**.
  - To set and save additional countdown timers, select **Add Timer**, and enter the time.
  - To set a countdown timer without saving it, select **Quick Timer**, and enter the time.
- 4 If necessary, press **MENU**, and select an option:
  - Select **Time** to change the time.
  - Select **Restart > On** to automatically restart the timer after it expires.
  - Select **Sounds**, and select a type of notification.
- 5 Press **START** to start the timer.



## Deleting a Timer

- 1 From the watch face, hold **MENU**.
- 2 Select **Clocks > TIMERS > Edit**.
- 3 Select a timer.
- 4 Select **Delete**.

## Using the Stopwatch

- 1 From the watch face, hold **MENU**.
- 2 Select **Clocks > STOPWATCH**.
- 3 Press **START** to start the timer.
- 4 Press **LAP** to restart the lap timer ①.

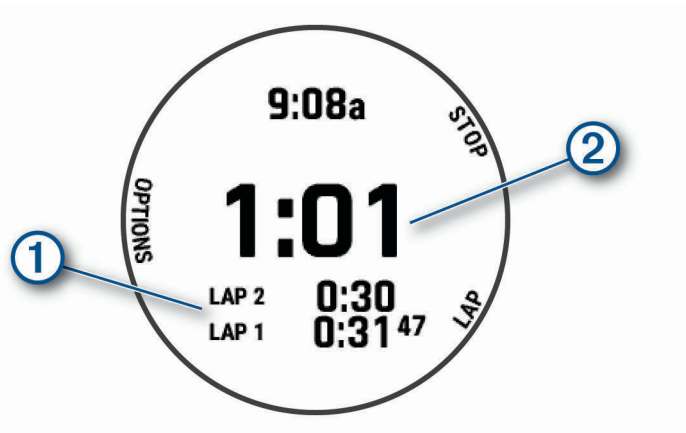

The total stopwatch time ② continues running.

- 5 Press **STOP** to stop both timers.
- 6 Select an option:
  - To reset both timers, press **DOWN**.
  - To save the stopwatch time as an activity, press **MENU**, and select **Save Activity**.
  - To reset the timers and exit the stopwatch, press **MENU**, and select **Done**.
  - To review the lap timers, press **MENU**, and select **Review**.  
**NOTE:** The **Review** option only appears if there have been multiple laps.
  - To return to the watch face without resetting the timers, press **MENU**, and select **Go to Watchface**.
  - To enable or disable lap recording, press **MENU**, and select **Lap Key**.

## Adding Alternate Time Zones

You can display the current time of day in additional time zones on the alternate time zones widget. You can add up to four alternate time zones.

**NOTE:** You may need to add the alternate time zones widget to the widget loop ([Customizing the Widget Loop, page 93](#)).

- 1 From the watch face, hold **MENU**.
- 2 Select **Clocks > ALT. TIME ZONES > Add Alt. Time Zone**.
- 3 Select an option:
  - Select **Use Airport Ident.** to search for a time zone by entering the alphanumeric identifier for an aviation waypoint.
  - Select **Use Map** to choose a time zone for a geographic location.
- 4 Select a time zone.
- 5 If necessary, rename the zone.

## Editing an Alternate Time Zone

- 1 From the watch face, hold **MENU**.
- 2 Select **Clocks > ALT. TIME ZONES > Edit**.
- 3 Select a time zone.
- 4 Select an option:
  - To enter a custom name for the time zone, select **Rename Zone**.
  - To change the time zone, select **Change Zone**.
  - To change the location of the time zone in the widget, select **Reorder Zone**.
  - To delete the time zone, select **Delete Zone**.

# Navigation

## Saving Your Location

You can save your current location to navigate back to it later.

**NOTE:** You can add options to the controls menu ([Customizing the Controls Menu, page 97](#)).

- 1 Hold **LIGHT**.
- 2 Select .
- 3 Follow the on-screen instructions.

## Editing Your Saved Locations

You can delete a saved location or edit its name, elevation, and position information.

- 1 From the watch face, press **START**.
- 2 Select **Navigate > Saved Locations**.
- 3 Select a saved location.
- 4 Select an option to edit the location.

## Projecting a Waypoint

You can create a new location by projecting the distance and bearing from your current location to a new location.

**NOTE:** You may need to add the Project Wpt. app to the activities and apps list.

- 1 From the watch face, press **START**.
- 2 Select **Project Wpt.**
- 3 Press **UP** or **DOWN** to set the heading.
- 4 Press **START**.
- 5 Press **DOWN** to select a unit of measure.
- 6 Press **UP** to enter the distance.
- 7 Press **START** to save.

The projected waypoint is saved with a default name.

## Navigating to a Destination

You can use your device to navigate to a destination or follow a course.

- 1 From the watch face, press **START**.
- 2 Select an activity.
- 3 Hold **MENU**.
- 4 Select **Navigation**.
- 5 Select a category.
- 6 Respond to the on-screen prompts to choose a destination.
- 7 Select **Go**.  
Navigation information appears.
- 8 Press **START** to begin navigation.

## Navigating to a Point of Interest

If the map data installed on your device includes points of interest, you can navigate to them.

- 1 From the watch face, press **START**.
- 2 Select an activity.
- 3 Hold **MENU**.
- 4 Select **Navigation > Points of Interest**, and select a category.  
A list of points of interest near your current location appears.
- 5 If necessary, select an option:
  - To search near a different location, select **Search Near**, and select a location.
  - To search for a point of interest by name, select **Spell Search**, enter a name, select **Search Near**, and select a location.
- 6 Select a point of interest from the search results.
- 7 Select **Go**.  
Navigation information appears.
- 8 Press **START** to begin navigation.

## Points of Interest

A point of interest is a place that you may find useful or interesting. Points of interest are organized by category and can include popular travel destinations such as gas stations, restaurants, hotels, and entertainment venues.

## Creating and Following a Course on Your Device

- 1 From the watch face, press **START**.
- 2 Select an activity.
- 3 Hold **MENU**.
- 4 Select **Navigation > Courses > Create New**.
- 5 Enter a name for the course, and select **✓**.
- 6 Select **Add Location**.
- 7 Select an option.
- 8 If necessary, repeat steps 6 and 7.
- 9 Select **Done > Do Course**.  
Navigation information appears.
- 10 Press **START** to begin navigation.

## Creating a Round-Trip Course

The device can create a round-trip course based on a specified distance and direction of navigation.

- 1 From the watch face, press **START**.
- 2 Select **Run** or **Bike**.
- 3 Hold **MENU**.
- 4 Select **Navigation > Round-Trip Course**.
- 5 Enter the total distance for the course.
- 6 Select a direction heading.  
The device creates up to three courses. You can press **DOWN** to view the courses.
- 7 Press **START** to select a course.
- 8 Select an option:
  - To begin navigation, select **Go**.
  - To view the course on the map and pan or zoom the map, select **Map**.
  - To view a list of turns in the course, select **Turn By Turn**.
  - To view an elevation plot of the course, select **Elevation Plot**.
  - To save the course, select **Save**.
  - To view a list of ascents in the course, select **View Climbs**.

## Viewing or Editing Course Details

You can view or edit course details before you navigate a course.

- 1 From the watch face, press **START**.
- 2 Select an activity.
- 3 Hold **MENU**.
- 4 Select **Navigation > Courses**.
- 5 Press **START** to select a course.
- 6 Select an option:
  - To begin navigation, select **Do Course**.
  - To view the course on the map and pan or zoom the map, select **Map**.
  - To begin the course in reverse, select **Do Course in Reverse**.
  - To view an elevation plot of the course, select **Elevation Plot**.
  - To change the course name, select **Name**.
  - To edit the course path, select **Edit**.
  - To view a list of ascents in the course, select **View Climbs**.
  - To delete the course, select **Delete**.



## Using ClimbPro

The ClimbPro feature helps you manage your effort for the upcoming climbs on a course. You can view climb details, including gradient, distance, and elevation gain, before or in real time while following a course. Cycling climb categories, based on length and gradient, are indicated by color.

- 1 Hold **MENU**.
- 2 Select **Activities & Apps**.
- 3 Select an activity.
- 4 Select the activity settings.
- 5 Select **ClimbPro > Status > On**.
- 6 Select an option:
  - Select **Data Field** to customize the data field that appears on the ClimbPro screen.
  - Select **Alert** to set alerts at the start of a climb or at a certain distance from the climb.
  - Select **Descents** to turn descents on or off for running activities.
- 7 Review the climbs and course details for the course ([Viewing or Editing Course Details, page 75](#)).
- 8 Start following a saved course ([Navigating to a Destination, page 74](#)).

## Navigating with Sight 'N Go

You can point the device at an object in the distance, such as a water tower, lock in the direction, and then navigate to the object.

- 1 From the watch face, press **START**.
- 2 Select an activity.
- 3 Hold **MENU**.
- 4 Select **Navigation > Sight 'N Go**.
- 5 Point the top of the watch at an object, and press **START**.  
Navigation information appears.
- 6 Press **START** to begin navigation.

## Navigating to Your Starting Point During an Activity

You can navigate back to the starting point of your current activity in a straight line or along the path you traveled. This feature is available only for activities that use GPS.

- 1 During an activity, press **STOP**.
- 2 Select **Back to Start**, and select an option:
  - To navigate back to the starting point of your activity along the path you traveled, select **TracBack**.
  - If you do not have a supported map or are using direct routing, select **Route** to navigate back to the starting point of your activity in a straight line.
  - If you are not using direct routing, select **Route** to navigate back to the starting point of your activity using turn-by-turn directions.

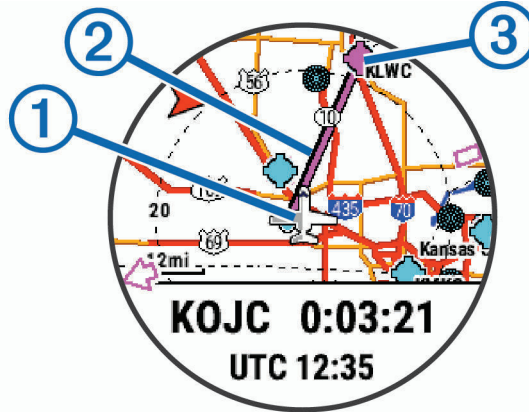

Your current location ①, the track to follow ②, and your destination ③ appear on the map.

## Viewing Route Directions

You can view a list of turn-by-turn directions for your route.

- 1 While navigating a route, hold **MENU**.
- 2 Select **Turn By Turn**.  
A list of turn-by-turn directions appears.
- 3 Press **DOWN** to view additional directions.

## Navigating to the Starting Point of a Saved Activity

You can navigate back to the starting point of a saved activity in a straight line or along the path you traveled. This feature is available only for activities that use GPS.

- 1 From the watch face, press **START**.
- 2 Select an activity.
- 3 Hold **MENU**.
- 4 Select **Navigation > Activities**.
- 5 Select an activity.
- 6 Select **Back to Start**, and select an option:
  - To navigate back to the starting point of your activity along the path you traveled, select **TracBack**.
  - If you do not have a supported map or are using direct routing, select **Route** to navigate back to the starting point of your activity in a straight line.
  - If you are not using direct routing, select **Route** to navigate back to the starting point of your activity using turn-by-turn directions.

Turn-by-turn directions help you navigate to the starting point of your last saved activity if you have a supported map or are using direct routing. A line appears on the map from your current location to the starting point of the last saved activity if you are not using direct routing.

**NOTE:** You can start the timer to prevent the device from timing out to watch mode.

- 7 Press **DOWN** to view the compass (optional).  
The arrow points toward your starting point.

## Stopping Navigation

- 1 During an activity, hold **MENU**.
- 2 Select **Stop Navigation**.

## Map

Your device comes preloaded with maps and can display several types of Garmin map data, including topographical contours, nearby points of interest, ski resort maps, and golf courses.

To purchase additional map data and view compatibility information, go to [garmin.com/maps](https://garmin.com/maps).

▲ represents your location on the map. When you are navigating to a destination, your route is marked with a line on the map.

## Viewing the Map

- 1 Start an outdoor activity.
- 2 Press **UP** or **DOWN** to scroll to the map screen.
- 3 Hold **MENU**, and select an option:
  - To pan or zoom the map, select **Pan/Zoom**.  
**TIP:** You can press **START** to toggle between panning up and down, panning left and right, or zooming. You can hold **START** to select the point indicated by the crosshairs.
  - To see nearby points of interest and waypoints, select **Around Me**.

## Saving or Navigating to a Location on the Map

You can select any location on the map. You can save the location or start navigating to it.

- 1 From the map, hold **MENU**.
- 2 Select **Pan/Zoom**.  
Controls and crosshairs appear on the map.

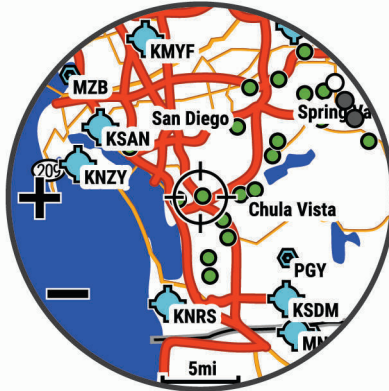

- 3 Pan and zoom the map to center the location in the crosshairs.
- 4 Hold **START** to select the point indicated by the crosshairs.
- 5 If necessary, select a nearby point of interest.
- 6 Select an option:
  - To download the weather radar image associated with the selected location, select **Show NEXRAD** ([Viewing NEXRAD Weather Radar, page 5](#)).
  - To start navigating to the location, select **Go**.
  - To save the location, select **Save Location**.
  - To view information about the location, select **Review**.

## Navigating with the Around Me Feature

You can use the around me feature to navigate to nearby points of interest and waypoints.

**NOTE:** The map data installed on your device must include points of interest to navigate to them.

- 1 From the map, hold **MENU**.
- 2 Select **Around Me**.  
Icons indicating points of interest and waypoints appear on the map.
- 3 Press **UP** or **DOWN** to highlight a section of the map.
- 4 Press **STOP**.  
A list of points of interest and waypoints in the highlighted map section appear.
- 5 Select a location.
- 6 Select an option:
  - To download the weather radar image associated with the selected location, select **Show NEXRAD** ([Viewing NEXRAD Weather Radar, page 5](#)).
  - To start navigating to the location, select **Go**.
  - To view the location on the map, select **Map**.
  - To save the location, select **Save Location**.
  - To view information about the location, select **Review**.

## Changing the Map Theme

You can change the map theme to display map data optimized for your activity type. For example, high contrast map themes provide better visibility in challenging environments, and activity-specific map themes display the most important map data at-a-glance.

- 1 Start an outdoor activity.
- 2 Hold **MENU**.
- 3 Select the activity settings.
- 4 Select **Map > Map Theme**.
- 5 Select an option.

## Compass

The device has a 3-axis compass with automatic calibration. The compass features and appearance change depending on your activity, whether GPS is enabled, and whether you are navigating to a destination. You can change the compass settings manually ([Compass Settings, page 98](#)). To open the compass settings quickly, you can press **START** from the compass widget.

### Setting the Compass Heading

- 1 From the compass widget, press **START**.
- 2 Select **Lock Heading**.
- 3 Point the top of the watch toward your heading, and press **START**.  
When you deviate from the heading, the compass displays the direction from the heading and degree of deviation.

## Altimeter and Barometer

The device contains an internal altimeter and barometer. The device collects elevation and pressure data continuously, even in low-power mode. The altimeter displays your approximate elevation based on pressure changes. The barometer displays environmental pressure data based on the fixed elevation where the altimeter was most recently calibrated ([Altimeter Settings, page 99](#)). You can press **START** from the altimeter or barometer widgets to open the altimeter or barometer settings quickly.

### Altimeter Readings

The altimeter functions differently depending on the fixed or variable settings.

You can adjust the altimeter settings by holding **MENU**, selecting **Activities & Apps > FLY**, selecting the activity settings, and selecting **Altimeter**.

Sensor	Fixed	Variable
Altimeter with GPS On	Elevation is equal to GPS elevation.	Elevation reflects changes in ambient pressure and GPS position.
Altimeter with GPS Off	Elevation remains constant.	Elevation reflects changes in ambient pressure.

## History

History includes time, distance, calories, average pace or speed, lap data, and optional sensor information.

**NOTE:** When the device memory is full, your oldest data is overwritten.

## Using History

History contains previous activities you have saved on your device.

The device has a history widget for quick access to your activity data ([Widgets, page 92](#)).

- 1 From the watch face, hold **MENU**.
- 2 Select **History > Activities**.
- 3 Select an activity.
- 4 Press **START**.
- 5 Select an option:
  - To view additional information about the activity, select **All Stats**.
  - To view the impact of the activity on your aerobic and anaerobic fitness, select **Training Effect** ([About Training Effect, page 48](#)).
  - To view your time in each heart rate zone, select **Heart Rate** ([Viewing Your Time in Each Heart Rate Zone, page 81](#)).
  - To select a lap and view additional information about each lap, select **Laps**.
  - To select a ski or snowboard run and view additional information about each run, select **Runs**.
  - To select an exercise set and view additional information about each set, select **Sets**.
  - To view the activity on a map, select **Map**.
  - To view an elevation plot for the activity, select **Elevation Plot**.
  - To delete the selected activity, select **Delete**.

## Multisport History

Your device stores the overall multisport summary of the activity, including overall distance, time, calories, and optional accessory data. Your device also separates the activity data for each sport segment and transition so you can compare similar training activities and track how quickly you move through the transitions. Transition history includes distance, time, average speed, and calories.

## Viewing Your Time in Each Heart Rate Zone

Viewing your time in each heart rate zone can help you adjust your training intensity.

- 1 From the watch face, hold **MENU**.
- 2 Select **History > Activities**.
- 3 Select an activity.
- 4 Select **Heart Rate**.

## Viewing Data Totals

You can view the accumulated distance and time data saved to your device.

- 1 From the watch face, hold **MENU**.
- 2 Select **History > Totals**.
- 3 If necessary, select an activity.
- 4 Select an option to view weekly or monthly totals.

## Using the Odometer

The odometer automatically records the total distance traveled, elevation gained, and time in activities.

- 1 From the watch face, hold **MENU**.
- 2 Select **History > Totals > Odometer**.
- 3 Press **UP** or **DOWN** to view odometer totals.



## Deleting History

- 1 From the watch face, hold **MENU**.
- 2 Select **History > Options**.
- 3 Select an option:
  - Select **Delete All Activities** to delete all activities from the history.
  - Select **Reset Totals** to reset all distance and time totals.

**NOTE:** This does not delete any saved activities.

# Customizing Your Device

## Aviation Settings

Hold **MENU**, and select **Aviation**.

**Aviation Units:** Sets the units of measure used for aviation data.

**Airport Search:** Sets the airport options that appear when searching for airports. For example, you can set the minimum runway length and surface material, and indicate whether private airports and heliports are displayed in search results.

**Ownship:** Sets the aircraft type to helicopter or plane.

**Altimeter Settings & Alerts:** Allows you to customize the altimeter settings ([Altimeter Settings, page 99](#)).

**NEXRAD Tiles:** Allows you to display a single patch of NEXRAD data, or display additional NEXRAD data patches based on a direction from your current location.

**NEXRAD Vibe:** Sets the device to vibrate when a NEXRAD patch download completes.

**Connex:** Allows you to pair a Connex device to display aircraft information ([Pairing a Connex Device, page 32](#)). You can also receive and transmit your GPS position from a paired device.

**Cross Track Alert:** Sets the device to vibrate when you deviate from your course by a specific distance. You can use the Vibe Pattern option to preview the vibration patterns before you fly.

**Fuel Tank Reminder:** Sets an alarm to sound or vibrate after a specific number of minutes and displays a message to check the fuel tank gauges. You can use the Vibe Pattern option to preview the vibration patterns before you fly.

## Activities and App Settings

These settings allow you to customize each preloaded activity app based on your needs. For example, you can customize data pages and enable alerts and training features. Not all settings are available for all activity types. Hold **MENU**, select **Activities & Apps**, select an activity, and select the activity settings.

**3D Distance:** Calculates your distance traveled using your elevation change and your horizontal movement over ground.

**3D Speed:** Calculates your speed using your elevation change and your horizontal movement over ground ([3D Speed and Distance](#), page 89).

**Accent Color:** Sets the accent color of each activity to help identify which activity is active.

**Add Activity:** Allows you to customize a multisport activity.

**Alerts:** Sets the training or navigation alerts for the activity.

**Altimeter:** Displays the pressure altitude, or GPS altitude, when the device has a GPS fix.

**Auto Climb:** Enables the device to detect elevation changes automatically using the built-in altimeter.

**Auto Fly:** In watch mode, allows a flight activity to begin automatically when the detected climb rate exceeds a specified speed. The activity stops when the ground speed drops below 30 kn for a specified time.

**Auto Lap:** Sets the options for the Auto Lap feature ([Auto Lap](#), page 88).

**Auto Pause:** Sets the device to stop recording data when you stop moving or when you drop below a specified speed ([Enabling Auto Pause](#), page 89).

**Auto Rest:** Enables the device to automatically detect when you are resting during a pool swim and create a rest interval ([Auto Rest](#), page 20).

**Auto Run:** Enables the device to detect ski runs automatically using the built-in accelerometer.

**Auto Scroll:** Enables you to move through all of the activity data screens automatically while the timer is running ([Using Auto Scroll](#), page 90).

**Auto Set:** Enables the device to start and stop exercise sets automatically during a strength training activity.

**Background Color:** Sets the background color of each activity to black or white.

**Big Numbers:** Changes the size of the numbers on the golf hole information screen.

**ClimbPro:** Displays ascent planning and monitoring screens while navigating.

**Club Prompt:** Displays a prompt that enables you to enter which club you used after each detected shot while playing golf.

**Countdown Start:** Enables a countdown timer for pool swimming intervals.

**Data Screens:** Enables you to customize data screens and add new data screens for the activity ([Customizing the Data Screens](#), page 85).

**Driver Distance:** Sets the average distance the ball travels on your drive while playing golf.

**Edit Routes:** Allows you to edit the route difficulty level and status during a rock climbing activity.

**Edit Weight:** Allows you to add the weight used for an exercise set during a strength training or cardio activity.

**Flight Timer:** From the FLY app, allows the flight timer to start and stop automatically when your ground speed exceeds the value set in the Flight Timer Threshold option.

**Flight Timer Threshold:** From the FLY app, allows the flight timer to start and stop automatically when your ground speed exceeds this value. For example, 30 kn.

**Golf Distance:** Set the unit of measure used while playing golf.

**GPS:** Sets the mode for the GPS antenna ([Changing the GPS Setting](#), page 90).

**Grading System:** Sets the grading system for rating the route difficulty for rock climbing activities.

**Handicap Scoring:** Enables handicap scoring while playing golf. The Local Handicap option allows you to enter the number of strokes to be subtracted from your total score. The Index/Slope option allows you to enter your handicap and the course slope rating so the device can calculate your course handicap. When you enable either handicap scoring option, you can adjust your handicap value.

**HSI Data:** Allows you to customize the configurable data field on the horizontal situation indicator. You can display a distance or speed value.

**Lane Number:** Sets your lane number for track running.

**Lap Key:** Enables you to record a lap or a rest during the activity.

**Lock Keys:** Locks the keys during multisport activities to prevent accidental key presses.

**Map:** Sets the display preferences for the map data screen for the activity ([Activity Map Settings, page 87](#)).

**Metronome:** Plays tones at a steady rhythm to help you improve your performance by training at a faster, slower, or more consistent cadence ([Using the Metronome, page 17](#)).

**PlaysLike:** Enables the "plays like" distance feature while playing golf, which accounts for elevation changes on the course by showing the adjusted distance to the green ([Viewing PlaysLike Distance, page 25](#)).

**Pool Size:** Sets the pool length for pool swimming.

**Power Averaging:** Controls whether the device includes zero values for power data that occur when you are not pedaling.

**Power Mode:** Sets the default power mode for the activity.

**Power Save Timeout:** Sets the power-save timeout options for the activity ([Power Save Timeout Settings, page 91](#)).

**Record Activity:** Enables activity FIT file recording for golf activities. FIT files record fitness information that is tailored for Garmin Connect.

**Record VO2 Max.:** Enables VO2 max. recording for trail run and ultra run activities.

**Rename:** Sets the activity name.

**Repeat:** Enables the Repeat option for multisport activities. For example, you can use this option for activities that include multiple transitions, such as a swimrun.

**Restore Defaults:** Allows you to reset the activity settings.

**Route Stats:** Enables route statistics tracking for indoor climbing activities.

**Routing:** Sets the preferences for calculating routes for the activity ([Routing Settings, page 88](#)).

**Scoring:** Enables or disables scorekeeping automatically when you start a round of golf. The Always Ask option prompts you when you begin a round.

**Scoring Method:** Sets the scoring method to stroke play or Stableford scoring while playing golf.

**Self Evaluation:** Sets how often you evaluate your perceived effort for the activity ([Enabling Self Evaluation, page 71](#)).

**Segment Alerts:** Enables prompts that alert you to approaching segments.

**Stat Tracking:** Enables statistics tracking while playing golf.

**Stroke Detect.:** Enables stroke detection for pool swimming.

**Swimrun Auto Sport Change:** Allows you to automatically transition between the swim portion and the run portion of a swimrun multisport activity.

**Tournament Mode:** Disables features that are not allowed during sanctioned tournaments.

**Transitions:** Enables transitions for multisport activities.

**Vibration Alerts:** Enables alerts that notify you to inhale or exhale during a breathwork activity.

**Workout Videos:** Enables instructive workout animations for a strength, cardio, yoga, or Pilates activity. Animations are available for pre-installed workouts and workouts downloaded from Garmin Connect.

## Customizing the Data Screens

You can show, hide, and change the layout and content of data screens for each activity.

- 1 Hold **MENU**.
- 2 Select **Activities & Apps**.
- 3 Select the activity to customize.
- 4 Select the activity settings.
- 5 Select **Data Screens**.
- 6 Select a data screen to customize.
- 7 Select an option:
  - Select **Layout** to adjust the number of data fields on the data screen.
  - Select **Data Fields**, and select a field to change the data that appears in the field.
  - Select **Reorder** to change the location of the data screen in the loop.
  - Select **Remove** to remove the data screen from the loop.
- 8 If necessary, select **Add New** to add a data screen to the loop.

You can add a custom data screen, or select one of the predefined data screens.

## Adding a Map to an Activity

You can add the map to the data screens loop for an activity.

- 1 Hold **MENU**.
- 2 Select **Activities & Apps**.
- 3 Select the activity to customize.
- 4 Select the activity settings.
- 5 Select **Data Screens > Add New > Map**.



## Alerts

You can set alerts for each activity, which can help you to train toward specific goals, to increase your awareness of your environment, and to navigate to your destination. Some alerts are available only for specific activities. There are three types of alerts: event alerts, range alerts, and recurring alerts.

**Event alert:** An event alert notifies you once. The event is a specific value. For example, you can set the device to alert you when you burn a specified number of calories.

**Range alert:** A range alert notifies you each time the device is above or below a specified range of values. For example, you can set the device to alert you when your heart rate is below 60 beats per minute (bpm) and over 210 bpm.

**Recurring alert:** A recurring alert notifies you each time the device records a specified value or interval. For example, you can set the device to alert you every 30 minutes.

Alert Name	Alert Type	Description
Cadence	Range	You can set minimum and maximum cadence values.
Calories	Event, recurring	You can set the number of calories.
Custom	Event, recurring	You can select an existing message or create a custom message and select an alert type.
Distance	Recurring	You can set a distance interval.
Elevation	Range	You can set minimum and maximum elevation values.
Heart Rate	Range	You can set minimum and maximum heart rate values or select zone changes. See <a href="#">About Heart Rate Zones, page 57</a> and <a href="#">Heart Rate Zone Calculations, page 58</a> .
Pace	Range	You can set minimum and maximum pace values.
Pacing	Recurring	You can set a target swim pace.
Power	Range	You can set the high or low power level.
Proximity	Event	You can set a radius from a saved location.
Run/Walk	Recurring	You can set timed walking breaks at regular intervals.
Speed	Range	You can set minimum and maximum speed values.
Stroke Rate	Range	You can set high or low strokes per minute.
Time	Event, recurring	You can set a time interval.
Track Timer	Recurring	You can set a track time interval in seconds.



## Setting an Alert

- 1 Hold **MENU**.
- 2 Select **Activities & Apps**.
- 3 Select an activity.  
**NOTE:** This feature is not available for all activities.
- 4 Select the activity settings.
- 5 Select **Alerts**.
- 6 Select an option:
  - Select **Add New** to add a new alert for the activity.
  - Select the alert name to edit an existing alert.
- 7 If necessary, select the type of alert.
- 8 Select a zone, enter the minimum and maximum values, or enter a custom value for the alert.
- 9 If necessary, turn on the alert.

For event and recurring alerts, a message appears each time you reach the alert value. For range alerts, a message appears each time you exceed or drop below the specified range (minimum and maximum values).

## Activity Map Settings

You can customize the appearance of the map data screen for each activity.

Hold **MENU**, select **Activities & Apps**, select an activity, select the activity settings, and select **Map**.

**Configure Maps:** Shows or hides data from installed map products.

**Map Theme:** Sets the map to display data optimized for your activity type. The System option uses the preferences from the system map settings ([Map Themes, page 100](#)).

**Use Sys. Settings:** Enables the device to use the preferences from the system map settings ([Map Settings, page 100](#)).

**Orientation:** Sets the orientation of the map. The North Up option shows north at the top of the screen. The Track Up option shows your current direction of travel at the top of the screen.

**User Locations:** Shows or hides saved locations on the map.

**Auto Zoom:** Automatically selects the zoom level for optimal use of your map. When disabled, you must zoom in or out manually.

**Lock on Road:** Locks the position icon, which represents your position on the map, onto the nearest road.

**Track Log:** Shows or hides the track log, or the path you have traveled, as a colored line on the map.

**Track Color:** Changes the track log color.

**Detail:** Sets the amount of detail shown on the map. Showing more detail may cause the map to redraw more slowly.

**Marine:** Sets the map to display data in marine mode ([Marine Map Settings, page 101](#)).

**Draw Segments:** Shows or hides segments, as a colored line on the map.

**Draw Contours:** Shows or hides contour lines on the map.



## Routing Settings

You can change the routing settings to customize the way the device calculates routes for each activity.

Hold **MENU**, select **Activities & Apps**, select an activity, select the activity settings, and select **Routing**.

**Activity:** Sets an activity for routing. The device calculates routes optimized for the type of activity you are doing.

**Popularity Routing:** Calculates routes based on the most popular runs and rides from Garmin Connect.

**Courses:** Sets how you navigate courses using the device. Use the Follow Course option to navigate a course exactly as it appears, without recalculating. Use the Use Map option to navigate a course using routable maps, and recalculate the route if you stray from the course.

**Calculation Method:** Sets the calculation method to minimize the time, distance, or ascent in routes.

**Avoidances:** Sets the road or transportation types to avoid in routes.

**Type:** Sets the behavior of the pointer that appears during direct routing.

## Auto Lap

### Marking Laps by Distance

You can use Auto Lap to mark a lap at a specific distance automatically. This feature is helpful for comparing your performance over different parts of an activity (for example, every 1 mile or 5 kilometers).

- 1 Hold **MENU**.
- 2 Select **Activities & Apps**.
- 3 Select an activity.  
**NOTE:** This feature is not available for all activities.
- 4 Select the activity settings.
- 5 Select **Auto Lap**.
- 6 Select an option:
  - Select **Auto Lap** to turn Auto Lap on or off.
  - Select **Auto Distance** to adjust the distance between laps.

Each time you complete a lap, a message appears that displays the time for that lap. The device also beeps or vibrates if audible tones are turned on ([System Settings, page 103](#)).

### Customizing the Lap Alert Message

You can customize one or two data fields that appear in the lap alert message.

- 1 Hold **MENU**.
- 2 Select **Activities & Apps**.
- 3 Select an activity.  
**NOTE:** This feature is not available for all activities.
- 4 Select the activity settings.
- 5 Select **Auto Lap > Lap Alert**.
- 6 Select a data field to change it.
- 7 Select **Preview** (optional).

## Enabling Auto Pause

You can use the Auto Pause feature to pause the timer automatically when you stop moving. This feature is helpful if your activity includes stop lights or other places where you must stop.

**NOTE:** History is not recorded while the timer is stopped or paused.

- 1 Hold **MENU**.
- 2 Select **Activities & Apps**.
- 3 Select an activity.  
**NOTE:** This feature is not available for all activities.
- 4 Select the activity settings.
- 5 Select **Auto Pause**.
- 6 Select an option:
  - To pause the timer automatically when you stop moving, select **When Stopped**.
  - To pause the timer automatically when your pace or speed drops below a specified level, select **Custom**.

## Enabling Auto Climb

You can use the auto climb feature to detect elevation changes automatically. You can use it during activities such as climbing, hiking, running, or biking.

- 1 Hold **MENU**.
- 2 Select **Activities & Apps**.
- 3 Select an activity.  
**NOTE:** This feature is not available for all activities.
- 4 Select the activity settings.
- 5 Select **Auto Climb > Status**.
- 6 Select **Always** or **When Not Navigating**.
- 7 Select an option:
  - Select **Run Screen** to identify which data screen appears while running.
  - Select **Climb Screen** to identify which data screen appears while climbing.
  - Select **Invert Colors** to reverse the display colors when changing modes.
  - Select **Vertical Speed** to set the rate of ascent over time.
  - Select **Mode Switch** to set how quickly the device changes modes.**NOTE:** The Current Screen option allows you to automatically switch to the last screen you were viewing before the auto climb transition occurred.

## 3D Speed and Distance

You can set 3D speed and distance to calculate your speed or distance using both your elevation change and your horizontal movement over ground. You can use it during activities such as skiing, climbing, navigating, hiking, running, or biking.

## Turning On and Off the Lap Key

You can turn on the Lap Key setting to record a lap or a rest during an activity using LAP. You can turn off the Lap Key setting to avoid recording laps due to accidental key presses during an activity.

- 1 Hold **MENU**.
- 2 Select **Activities & Apps**.
- 3 Select an activity.
- 4 Select the activity settings.
- 5 Select **Lap Key**.  
The lap key status changes to On or Off based on the current setting.



## Using Auto Scroll

You can use the auto scroll feature to cycle through all of the activity data screens automatically while the timer is running.

- 1 Hold **MENU**.
- 2 Select **Activities & Apps**.
- 3 Select an activity.  
**NOTE:** This feature is not available for all activities.
- 4 Select the activity settings.
- 5 Select **Auto Scroll**.
- 6 Select a display speed.

## Changing the GPS Setting

For more information about GPS, go to [www.garmin.com/aboutGPS](http://www.garmin.com/aboutGPS).

- 1 Hold **MENU**.
- 2 Select **Activities & Apps**.
- 3 Select an activity.  
**NOTE:** This feature is not available for all activities.
- 4 Select the activity settings.
- 5 Select **GPS**.
- 6 Select an option:
  - Select **Off** to disable GPS for the activity.
  - Select **GPS Only** to enable the GPS satellite system.
  - Select **GPS + GLONASS** (Russian satellite system) for more accurate position information in situations with poor sky visibility.
  - Select **GPS + GALILEO** (European Union satellite system) for more accurate position information in situations with poor sky visibility.
  - Select **UltraTrac** to record track points and sensor data less frequently (*UltraTrac*, page 90).

**NOTE:** Using GPS and another satellite system together can reduce battery life more quickly than using GPS only (*GPS and Other Satellite Systems*, page 90).

## GPS and Other Satellite Systems

Using GPS and another satellite system together offers increased performance in challenging environments and faster position acquisition than using GPS only. However, using multiple systems can reduce battery life more quickly than using GPS only.

Your device can use these Global Navigation Satellite Systems (GNSS).

**GPS:** A satellite constellation built by the United States.

**GLONASS:** A satellite constellation built by Russia.

**GALILEO:** A satellite constellation built by the European Space Agency.

## UltraTrac

The UltraTrac feature is a GPS setting that records track points and sensor data less frequently. Enabling the UltraTrac feature increases battery life but decreases the quality of recorded activities. You should use the UltraTrac feature for activities that demand longer battery life and for which frequent sensor data updates are less important.

## Power Save Timeout Settings

The timeout settings affect how long your device stays in training mode, for example, when you are waiting for a race to start. Hold **MENU**, select **Activities & Apps**, select an activity, and select the activity settings. Select **Power Save Timeout** to adjust the timeout settings for the activity.

**Normal:** Sets the device to enter low-power watch mode after 5 minutes of inactivity.

**Extended:** Sets the device to enter low-power watch mode after 25 minutes of inactivity. The extended mode can result in shorter battery life between charges.

## Changing the Order of an Activity in the Apps List

- 1 Hold **MENU**.
- 2 Select **Activities & Apps**.
- 3 Select an activity.
- 4 Select **Reorder**.
- 5 Press **UP** or **DOWN** to adjust the position of the activity in the apps list.



## Widgets

Your device comes preloaded with widgets that provide at-a-glance information. Some widgets require a Bluetooth connection to a compatible smartphone.

Some widgets are not visible by default. You can add them to the widget loop manually ([Customizing the Widget Loop](#), page 93).

**ABC:** Displays combined altimeter, barometer, and compass information.

**Alternate time zones:** Displays the current time of day in additional time zones.

**Altitude acclimation:** At altitudes above 800 m (2625 ft.), displays graphs showing altitude-corrected values for your average pulse oximeter reading, respiration rate, and resting heart rate for the last seven days.

**Altimeter:** Displays the altitude alert threshold, pressure altitude, and barometric pressure correction.

**Body Battery:** With all day wear, displays your current Body Battery level and a graph of your level for the last several hours.

**Calendar:** Displays upcoming meetings from your smartphone calendar.

**Calories:** Displays your calorie information for the current day.

**Dog tracking:** Displays your dog's location information when you have a compatible dog tracking device paired with your MARQ device.

**Floors climbed:** Tracks your floors climbed and progress toward your goal.

**Garmin coach:** Displays scheduled workouts when you select a Garmin coach training plan in your Garmin Connect account.

**Golf:** Displays golf scores and statistics for your last round.

**Health stats:** Displays a dynamic summary of your current health statistics. The measurements includes heart rate, Body Battery level, stress, and more.

**Heart rate:** Displays your current heart rate in beats per minute (bpm) and a graph of your average resting heart rate (RHR).

**History:** Displays your activity history and a graph of your recorded activities.

**Intensity minutes:** Tracks your time spent participating in moderate to vigorous activities, your weekly intensity minutes goal, and progress toward your goal.

**inReach® controls:** Allows you to send messages on your paired inReach device.

**Last activity:** Displays a brief summary of your last recorded activity, such as your last run, last ride, or last swim.

**Last sport:** Displays a brief summary of your last recorded sport.

**METAR:** Displays the current sky conditions, weather conditions, visibility distance, temperature, dew point, barometric pressure, wind information, TAFs, and NEXRAD weather data on a map.

**Music controls:** Provides music player controls for your smartphone or on-device music.

**My day:** Displays a dynamic summary of your activity today. The metrics include timed activities, intensity minutes, floors climbed, steps, calories burned, and more.

**Notifications:** Alerts you to incoming calls, texts, social network updates, and more, based on your smartphone notification settings.

**Performance:** Displays performance measurements that help you track and understand your training activities and race performances.

**Pulse oximeter:** Allows you to take a manual pulse oximeter reading.

**Respiration:** Your current respiration rate in breaths per minute and seven-day average. You can do a breathing activity to help you relax.

**Sensor information:** Displays information from an internal sensor or a connected wireless sensor.

**Steps:** Tracks your daily step count, step goal, and data for previous days.

**Stress:** Displays your current stress level and a graph of your stress level. You can do a breathing activity to help you relax.

**Sunrise and sunset:** Displays sunrise, sunset, and civil twilight times.

**Training status:** Displays your current training status and training load, which shows you how your training affects your fitness level and performance.

**VIRB controls:** Provides camera controls when you have a VIRB device paired with your MARQ device.

**Weather:** Displays the current temperature and weather forecast.

**Xero® device:** Displays laser location information when you have a compatible Xero device paired with your MARQ device.

## Customizing the Widget Loop

You can change the order of widgets in the widget loop, remove widgets, and add new widgets.

- 1 Hold **MENU**.
- 2 Select **Widgets**.
- 3 Select **Widget Glances** to turn widget glances on or off.  
**NOTE:** Widget glances display summary data for multiple widgets on a single screen.
- 4 Select **Edit**.
- 5 Select a widget.
- 6 Select an option:
  - Press **UP** or **DOWN** to change the location of the widget in the widget loop.
  - Select  to remove the widget from the widget loop.
- 7 Select **Add**.
- 8 Select a widget.  
The widget is added to the widget loop.

## Altimeter

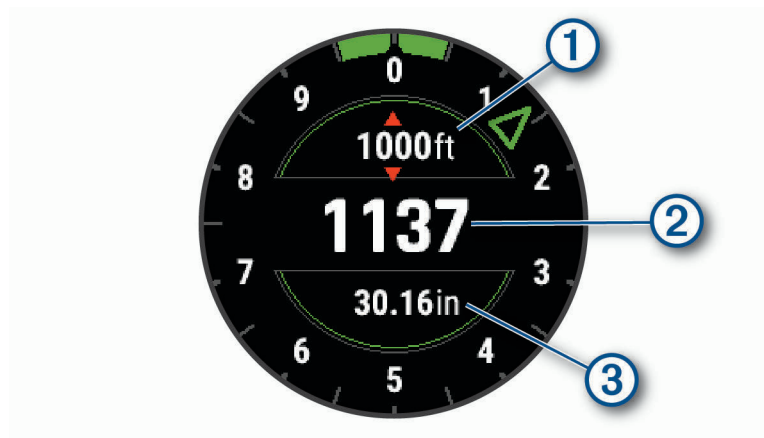

①	Alert altitude
②	Pressure altitude
③	Barometric pressure

## Temperature

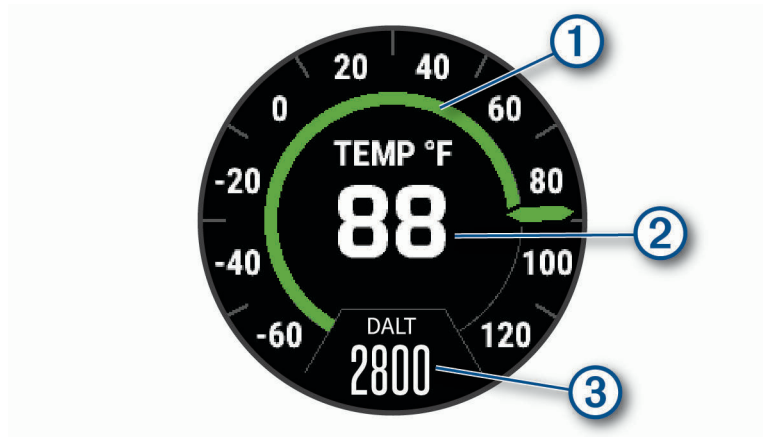

- |   |  |
|---|--|
| ① | Analog temperature   |
| ② | Digital temperature  |
| ③ | Density altitude from a compatible temperature sensor, such as the tempe™ sensor |

## METAR

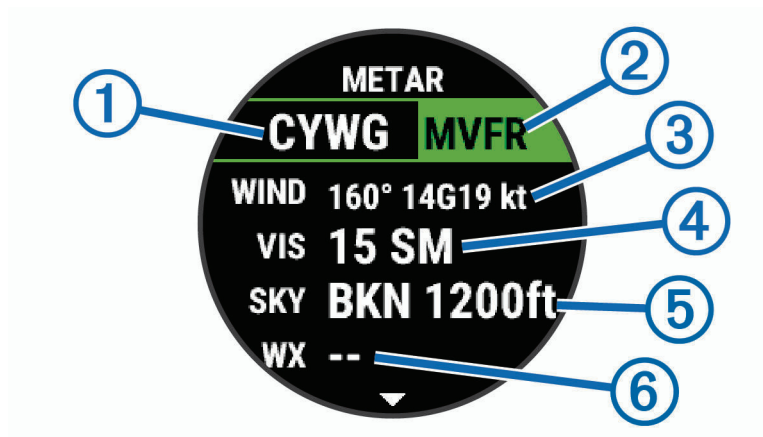

- |   |                                  |
|---|----------------------------------|
| ① | Airport identifier               |
| ② | Aviation flight category         |
| ③ | Wind direction, speed, and gusts |
| ④ | Visibility in statute miles      |
| ⑤ | Sky conditions                   |
| ⑥ | Weather conditions               |

## inReach Remote

The inReach remote function allows you to control your inReach device using your MARQ device. Go to [buy.garmin.com](http://buy.garmin.com) to purchase a compatible inReach device.

### Using the inReach Remote

Before you can use the inReach remote function, you must add the inReach widget to the widget loop (*Customizing the Widget Loop*, page 93).

- 1 Turn on the inReach device.
- 2 On your MARQ watch, press **UP** or **DOWN** from the watch face to view the inReach widget.
- 3 Press **START** to search for your inReach device.
- 4 Press **START** to pair your inReach device.
- 5 Press **START**, and select an option:
  - To send an SOS message, select **Initiate SOS**.  
**NOTE:** You should only use the SOS function in a real emergency situation.
  - To send a text message, select **Messages > New Message**, select the message contacts, and enter the message text or select a quick text option.
  - To send a preset message, select **Send Preset**, and select a message from the list.
  - To view the timer and distance traveled during an activity, select **Tracking**.

## VIRB Remote

The VIRB remote function allows you to control your VIRB action camera using your device.

### Controlling a VIRB Action Camera

Before you can use the VIRB remote function, you must enable the remote setting on your VIRB camera. See the *VIRB Series Owner's Manual* for more information.

- 1 Turn on your VIRB camera.
- 2 Pair your VIRB camera with your MARQ watch (*Pairing Your Wireless Sensors*, page 105).  
The VIRB widget is automatically added to the widget loop.
- 3 Press **UP** or **DOWN** from the watch face to view the VIRB widget.
- 4 If necessary, wait while your watch connects to your camera.
- 5 Select an option:
  - To record video, select **Start Recording**.  
The video counter appears on the MARQ screen.
  - To take a photo while recording video, press **DOWN**.
  - To stop recording video, press **STOP**.
  - To take a photo, select **Take Photo**.
  - To take multiple photos in burst mode, select **Take Burst**.
  - To send the camera to sleep mode, select **Sleep Camera**.
  - To wake the camera from sleep mode, select **Wake Camera**.
  - To change video and photo settings, select **Settings**.



## Controlling a VIRB Action Camera During an Activity

Before you can use the VIRB remote function, you must enable the remote setting on your VIRB camera. See the *VIRB Series Owner's Manual* for more information.

- 1 Turn on your VIRB camera.
- 2 Pair your VIRB camera with your MARQ watch (*Pairing Your Wireless Sensors, page 105*).  
When the camera is paired, a VIRB data screen is automatically added to activities.
- 3 During an activity, press **UP** or **DOWN** to view the VIRB data screen.
- 4 If necessary, wait while your watch connects to your camera.
- 5 Hold **MENU**.
- 6 Select **VIRB**.
- 7 Select an option:
  - To control the camera using the activity timer, select **Settings > Recording Mode > Timer Start/Stop**.  
**NOTE:** Video recording automatically starts and stops when you start and stop an activity.
  - To control the camera using the menu options, select **Settings > Recording Mode > Manual**.
  - To manually record video, select **Start Recording**.  
The video counter appears on the MARQ screen.
  - To take a photo while recording video, press **DOWN**.
  - To manually stop recording video, press **STOP**.
  - To take multiple photos in burst mode, select **Take Burst**.
  - To send the camera to sleep mode, select **Sleep Camera**.
  - To wake the camera from sleep mode, select **Wake Camera**.

## Using the Stress Level Widget

The stress level widget displays your current stress level and a graph of your stress level for the last several hours. It can also guide you through a breathing activity to help you relax.

- 1 While you are sitting or inactive, press **UP** or **DOWN** from the watch face to view the stress level widget.  
Your current stress level appears.  
**TIP:** If you are too active for the watch to determine your stress level, a message appears instead of a stress level number. You can check your stress level again after several minutes of inactivity.
- 2 Press **START** to view a graph of your stress level for the last four hours.  
Blue bars indicate periods of rest. Yellow bars indicate periods of stress. Gray bars indicate times when you were too active to determine your stress level.
- 3 Press **DOWN** to view additional details about your stress level and a graph of your average stress level for the last seven days.
- 4 To start a breathing activity, press **START**, and follow the on-screen instructions.

## Customizing the My Day Widget

You can customize the list of metrics displayed on the My Day widget.

- 1 From the watch face, press **UP** or **DOWN** to view the **My Day** widget.
- 2 Hold **MENU**.
- 3 Select **My Day Options**.
- 4 Select the toggle switches to show or hide each metric.



## Customizing the Controls Menu

You can add, remove, and change the order of the shortcut menu options in the controls menu ([Viewing the Controls Menu, page 2](#)).

- 1 Hold **MENU**.
- 2 Select **Controls**.
- 3 Select a shortcut to customize.
- 4 Select an option:
  - Select **Reorder** to change the location of the shortcut in the controls menu.
  - Select **Remove** to remove the shortcut from the controls menu.
- 5 If necessary, select **Add New** to add an additional shortcut to the controls menu.

## Watch Face Settings

You can customize the appearance of the watch face by selecting the layout, colors, and additional data. You can also download custom watch faces from the Connect IQ store.

### Default Watch Face



- ① Alternate time zone pointer. References the 24-hour time markings on the watch, in up to four alternate time zones ([Adding Alternate Time Zones, page 72](#)).
- ② Coordinated Universal Time (UTC) hand. References the 24-hour time markings on the watch.

## Customizing the Watch Face

Before you can activate a Connect IQ watch face, you must install a watch face from the Connect IQ store ([Connect IQ Features, page 35](#)).

You can customize the watch face information and appearance, or activate an installed Connect IQ watch face.

- 1 From the watch face, hold **MENU**.
- 2 Select **Watch Face**.
- 3 Press **UP** or **DOWN** to preview the watch face options.
- 4 Select **Add New** to scroll through additional pre-loaded watch faces.
- 5 Select **START > Apply** to activate a pre-loaded watch face or an installed Connect IQ watch face.
- 6 If using a pre-loaded watch face, select **START > Customize**.
- 7 Select an option:
  - To add alternate time zones to the aviation-specific analog watch face, select **ALT. TIME ZONES**.
  - To change the style of the numbers for the analog watch face, select **Dial**.
  - To change the sport for the gauges on the performance watch face, select **Select Sport**.
  - To change the style of the hands for the analog watch face, select **Hands**.
  - To change the style of the numbers for the digital watch face, select **Layout**.
  - To change the style of the seconds for the digital watch face, select **Seconds**.
  - To change the data that appears on the watch face, select **Data**.
  - To add or change an accent color for the watch face, select **Accent Color**.
  - To add the plane's tail number to the aviation-specific analog watch face, select **Tail Number**.
  - To change the background color, select **Bkgd. Color**.
  - To save the changes, select **Done**.

## Sensors Settings

### Compass Settings

Hold **MENU**, and select **Sensors & Accessories > Compass**.

**Calibrate:** Allows you to manually calibrate the compass sensor ([Calibrating the Compass Manually, page 98](#)).

**Display:** Sets the directional heading on the compass to letters, degrees, or milliradians.

**North Ref.:** Sets the north reference of the compass ([Setting the North Reference, page 99](#)).

**Mode:** Sets the compass to use electronic-sensor data only (On), a combination of GPS and electronic-sensor data when moving (Auto), or GPS data only (Off).

### Calibrating the Compass Manually

#### NOTICE

Calibrate the electronic compass outdoors. To improve heading accuracy, do not stand near objects that influence magnetic fields, such as vehicles, buildings, and overhead power lines.

Your device was already calibrated at the factory, and the device uses automatic calibration by default. If you experience irregular compass behavior, for example, after moving long distances or after extreme temperature changes, you can manually calibrate the compass.

- 1 Hold **MENU**.
- 2 Select **Sensors & Accessories > Compass > Calibrate > Start**.
- 3 Follow the on-screen instructions.

**TIP:** Move your wrist in a small figure eight motion until a message appears.

## Setting the North Reference

You can set the directional reference used in calculating heading information.

- 1 Hold **MENU**.
- 2 Select **Sensors & Accessories > Compass > North Ref.**.
- 3 Select an option:
  - To set geographic north as the heading reference, select **True**.
  - To set the magnetic declination for your location automatically, select **Magnetic**.
  - To set grid north (000°) as the heading reference, select **Grid**.
  - To set the magnetic variation value manually, select **User**, enter the magnetic variance, and select **Done**.

## Altimeter Settings

Hold **MENU**, and select **Sensors & Accessories > Altimeter**.

**Barometer:** Allows you to set the barometric pressure manually, or select a value from the nearest METAR station through the Garmin Connect Mobile app.

**Altitude Alert:** Sets an alarm to vibrate when you reach a specified altitude.

**O2 Alert:** Sets an alarm to vibrate when you reach a low-oxygen altitude.

**Sync to Elevation:** Allows you to synchronize the device to your current elevation manually.

## Calibrating the Barometric Altimeter

Your device was already calibrated at the factory, and the device uses automatic calibration at your GPS starting point by default. You can manually calibrate the barometric altimeter if you know the correct elevation.

- 1 From the altimeter widget, hold **MENU**.
- 2 Select **Options**.
- 3 Select an option:
  - To enter the current elevation, select **Calibrate > Yes**.
  - To calibrate automatically from the digital elevation model, select **Calibrate > Use DEM**.
  - To calibrate automatically from your GPS starting point, select **Calibrate > Use GPS**.
  - To allow the altimeter to self-calibrate each time you turn on GPS tracking, select **Auto Cal. > On**.

## Barometer Settings

Hold **MENU**, and select **Sensors & Accessories > Barometer**.

**Calibrate:** Allows you to manually calibrate the barometer sensor.

**Plot:** Sets the time scale for the chart in the barometer widget.

**Storm Alert:** Sets the rate of barometric pressure change that triggers a storm alert.

**Watch Mode:** Sets the sensor used in watch mode. The Auto option uses both the altimeter and barometer according to your movement. You can use the Altimeter option when your activity involves changes in altitude, or the Barometer option when your activity does not involve changes in altitude.

**Pressure:** Sets how the device displays pressure data.

## Calibrating the Barometer

Your device was already calibrated at the factory, and the device uses automatic calibration at your GPS starting point by default. You can manually calibrate the barometer if you know the correct elevation or the correct sea level pressure.

- 1 Hold **MENU**.
- 2 Select **Sensors & Accessories > Barometer > Calibrate**.
- 3 Select an option:
  - To enter the current elevation and sea level pressure (optional), select **Yes**.
  - To calibrate automatically from the digital elevation model, select **Use DEM**.
  - To calibrate automatically from your GPS starting point, select **Use GPS**.

## Elevation Settings

Hold **MENU**, and select **Sensors & Accessories > Elevation**.

**Calibrate:** Allows you to calibrate the altimeter sensor manually.

**Auto Cal.:** Allows the altimeter to self-calibrate each time you turn on GPS tracking.

**Elevation:** Sets the units of measure for elevation.

## Xero Laser Location Settings

Before you can customize laser location settings, you must pair a compatible Xero device ([Pairing Your Wireless Sensors, page 105](#)).

Hold **MENU**, and select **Sensors & Accessories > XERO Locations > Laser Locations**.

**During Activity:** Enables the display of laser location information from a compatible, paired Xero device during an activity.

**Share Mode:** Allows you to share laser location information publicly or broadcast it privately.

## Map Settings

You can customize how the map appears in the map app and data screens.

**NOTE:** If necessary, you can customize the map settings for specific activities instead of using the system settings ([Activity Map Settings, page 87](#)).

Hold **MENU**, and select **Map**.

**Map Theme:** Sets the map to display data optimized for your activity type ([Map Themes, page 100](#)).

**Orientation:** Sets the orientation of the map. The North Up option shows north at the top of the screen. The Track Up option shows your current direction of travel at the top of the screen.

**User Locations:** Shows or hides saved locations on the map.

**Auto Zoom:** Automatically selects the zoom level for optimal use of your map. When disabled, you must zoom in or out manually.

**Lock on Road:** Locks the position icon, which represents your position on the map, onto the nearest road.

**Track Log:** Shows or hides the track log, or the path you have traveled, as a colored line on the map.

**Track Color:** Changes the track log color.

**Detail:** Sets the amount of detail shown on the map. Showing more detail may cause the map to redraw more slowly.

**Marine:** Sets the map to display data in marine mode ([Marine Map Settings, page 101](#)).

**Draw Segments:** Shows or hides segments, as a colored line on the map.

**Draw Contours:** Shows or hides contour lines on the map.

## Map Themes

You can change the map theme to display data optimized for your activity type.

Hold **MENU**, and select **Map > Map Theme**.

**None:** Uses the preferences from the system map settings, with no additional theme applied.

**Marine:** Sets the map to display data in marine mode.

**High Contrast:** Sets the map to display data with higher contrast, for better visibility in challenging environments.

**Dark:** Sets the map to display data with a dark background, for better visibility at night.

**Popularity:** Highlights the most popular roads or trails on the map.

**Resort Ski:** Sets the map to display the most relevant ski data at a glance.

**Restore Theme:** Allows you to restore map themes that have been deleted from the device.

## Marine Map Settings

You can customize how the map appears in marine mode.

Hold **MENU**, and select **Map > Marine**.

**Spot Soundings:** Enables depth measurements on the chart.

**Light Sectors:** Shows and configures the appearance of light sectors on the chart.

**Symbol Set:** Sets the chart symbols in marine mode. The NOAA option displays the National Oceanic and Atmospheric Administration chart symbols. The International option displays the International Association of Lighthouse Authorities chart symbols.

## Showing and Hiding Map Data

If you have multiple maps installed on your device, you can choose the map data to show on the map.

- 1 From the watch face, press **START**.
- 2 Select **Map**.
- 3 Hold **MENU**.
- 4 Select the map settings.
- 5 Select **Map > Configure Maps**.
- 6 Select a map to activate the toggle switch, which shows or hides the map data.

## Navigation Settings

You can customize the map features and appearance when navigating to a destination.

### Customizing Map Features

- 1 Hold **MENU**.
- 2 Select **Navigation > Data Screens**.
- 3 Select an option:
  - Select **Map** to turn on or off the map.
  - Select **Guide** to turn on or off the guide screen that displays the compass bearing or course to follow while navigating.
  - Select **Elevation Plot** to turn on or off the elevation plot.
  - Select a screen to add, remove, or customize.

### Setting Up a Heading Bug

You can set up a heading indicator to display on your data pages while navigating. The indicator points to your target heading.

- 1 Hold **MENU**.
- 2 Select **Navigation > Heading Bug**.

### Setting Navigation Alerts

You can set alerts to help you navigate to your destination.

- 1 Hold **MENU**.
- 2 Select **Navigation > Alerts**.
- 3 Select an option:
  - To set an alert for a specified distance from your final destination, select **Final Distance**.
  - To set an alert for the estimated time remaining until you reach your final destination, select **Final ETE**.
  - To set an alert when you stray from the course, select **Off Course**.
  - To enable turn-by-turn navigation prompts, select **Turn Prompts**.
- 4 If necessary, select **Status** to turn on the alert.
- 5 If necessary, enter a distance or time value, and select **✓**.

## Power Manager Settings

Hold **MENU**, and select **Power Manager**.

**Battery Saver:** Allows you to customize system settings to extend battery life in watch mode (*Customizing the Battery Saver Feature, page 102*).

**Power Modes:** Allows you to customize system settings, activity settings, and GPS settings to extend battery life during an activity (*Customizing Power Modes, page 102*).

**Battery Percentage:** Displays remaining battery life as a percentage.

**Battery Estimates:** Displays remaining battery life as an estimated number of days or hours.

## Customizing the Battery Saver Feature

The battery saver feature allows you to quickly adjust system settings to extend battery life in watch mode.

You can turn on the battery saver feature from the controls menu (*Viewing the Controls Menu, page 2*).

- 1 Hold **MENU**.
- 2 Select **Power Manager > Battery Saver**.
- 3 Select **Status** to turn on the battery saver feature.
- 4 Select **Edit**, and select an option:
  - Select **Watch Face** to enable a low-power watch face that updates once per minute.
  - Select **Music** to disable listening to music from your watch.
  - Select **Phone** to disconnect your paired phone.
  - Select **Wi-Fi** to disconnect from a Wi-Fi network.
  - Select **Activity Tracking** to turn off all-day activity tracking, including steps, floors climbed, intensity minutes, sleep tracking, and Move IQ events.
  - Select **Wrist Heart Rate** to turn off the wrist heart rate monitor.
  - Select **Backlight** to disable the automatic backlight.

The watch displays the hours of battery life gained with each setting change.
- 5 Select **During Sleep** to enable the battery saver feature during your normal sleep hours.  
**TIP:** You can set your normal sleep hours in the user settings on your Garmin Connect account.
- 6 Select **Low Battery Alert** to receive an alert when the battery is low.

## Customizing Power Modes

Your device comes preloaded with several power modes, allowing you to quickly adjust system settings, activity settings, and GPS settings to extend battery life during an activity. You can customize existing power modes and create new custom power modes.

- 1 Hold **MENU**.
- 2 Select **Power Manager > Power Modes**.
- 3 Select an option:
  - Select a power mode to customize.
  - Select **Add New** to create a custom power mode.
- 4 If necessary, enter a custom name.
- 5 Select an option to customize specific power mode settings.  
For example, you can change the GPS setting or disconnect your paired phone.  
The watch displays the hours of battery life gained with each setting change.
- 6 If necessary, select **Done** to save and use the custom power mode.

## Restoring a Power Mode

You can reset a preloaded power mode to the factory default settings.

- 1 Hold **MENU**.
- 2 Select **Power Manager > Power Modes**.
- 3 Select a preloaded power mode.
- 4 Select **Restore > Yes**.

## System Settings

Hold **MENU**, and select **System**.

**Language:** Sets the language displayed on the device.

**Time:** Adjusts the time settings ([Time Settings, page 103](#)).

**Backlight:** Adjusts the backlight settings ([Changing the Backlight Settings, page 104](#)).

**Sounds:** Sets the device sounds, such as key tones, alerts, and vibrations.

**Do Not Disturb:** Turns on or off do not disturb mode. Use the During Sleep option to turn on do not disturb mode automatically during your normal sleep hours. You can set your normal sleep hours on your Garmin Connect account.

**Hot Keys:** Allows you to assign shortcuts to device keys ([Customizing the Hot Keys, page 104](#)).

**Auto Lock:** Allows you to lock the keys automatically to prevent accidental key presses. Use the During Activity option to lock the keys during a timed activity. Use the Not During Activity option to lock the keys when you are not recording a timed activity.

**Units:** Sets the units of measure used on the device ([Changing the Units of Measure, page 104](#)).

**Format:** Sets general format preferences, such as the pace and speed shown during activities, the start of the week, and geographical position format and datum options.

**Data Recording:** Sets how the device records activity data. The Smart recording option (default) allows for longer activity recordings. The Every Second recording option provides more detailed activity recordings, but may not record entire activities that last for longer periods of time.

**USB Mode:** Sets the device to use MTP (media transfer protocol) or Garmin mode when connected to a computer.

**Reset:** Allows you to reset user data and settings ([Resetting All Default Settings, page 113](#)).

**Software Update:** Allows you to install software updates downloaded using Garmin Express. Use the Auto Update option to enable your device to download the latest software update when a Wi-Fi connection is available.

**About:** Displays device, software, license, and regulatory information.

## Time Settings

Hold **MENU**, and select **System > Time**.

**Time Format:** Sets the device to show time in a 12-hour, 24-hour, or military format.

**Set Time:** Sets the time zone for the device. The Auto option sets the time zone automatically based on your GPS position.

**Time:** Allows you to adjust the time if it is set to the Manual option.

**Alerts:** Allows you to set hourly alerts, as well as sunrise and sunset alerts that sound a specific number of minutes or hours before the actual sunrise or sunset occurs ([Setting Time Alerts, page 104](#)).

**Time Sync:** Allows you to manually sync the time when you change time zones, and to update for daylight saving time ([Syncing the Time, page 104](#)).

## Setting Time Alerts

- 1 Hold **MENU**.
- 2 Select **System > Time > Alerts**.
- 3 Select an option:
  - To set an alert to sound a specific number of minutes or hours before the actual sunset occurs, select **Til Sunset > Status > On**, select **Time**, and enter the time.
  - To set an alert to sound a specific number of minutes or hours before the actual sunrise occurs, select **Til Sunrise > Status > On**, select **Time**, and enter the time.
  - To set an alert to sound every hour, select **Hourly > On**.

## Syncing the Time

Each time you turn on the device and acquire satellites or open the Garmin Connect app on your paired phone, the device automatically detects your time zones and the current time of day. You can also manually sync the time when you change time zones, and to update for daylight saving time.

- 1 Hold **MENU**.
- 2 Select **System > Time > Time Sync**.
- 3 Wait while the device connects to your paired phone or locates satellites ([Acquiring Satellite Signals](#), page 113).  
**TIP:** You can press DOWN to switch the source.

## Changing the Backlight Settings

- 1 Hold **MENU**.
- 2 Select **System > Backlight**.
- 3 Select an option:
  - Select **During Activity**.
  - Select **Not During Activity**.
  - Select **During Sleep**.
- 4 Select an option:
  - Select **Keys** to turn on the backlight for key presses.
  - Select **Alerts** to turn on the backlight for alerts.
  - Select **Gesture** to turn on the backlight by raising and turning your arm to look at your wrist.
  - Select **Timeout** to set the length of time before the backlight turns off.
  - Select **Brightness** to set the brightness level of the backlight.

## Customizing the Hot Keys

You can customize the hold function of individual keys and combinations of keys.

- 1 Hold **MENU**.
- 2 Select **System > Hot Keys**.
- 3 Select a key or combination of keys to customize.
- 4 Select a function.

## Changing the Units of Measure

You can customize units of measure for distance, pace and speed, elevation, weight, height, and temperature.

- 1 Hold **MENU**.
- 2 Select **System > Units**.
- 3 Select a measurement type.
- 4 Select a unit of measure.

## Viewing Device Information

You can view device information, such as the unit ID, software version, regulatory information, and license agreement.

- 1 Hold **MENU**.
- 2 Select **System > About**.

## Viewing E-label Regulatory and Compliance Information

The label for this device is provided electronically. The e-label may provide regulatory information, such as identification numbers provided by the FCC or regional compliance markings, as well as applicable product and licensing information.

- 1 Hold **MENU**.
- 2 From the system menu, select **About**.

## Wireless Sensors

Your device can be used with wireless ANT+ or Bluetooth sensors. For more information about compatibility and purchasing optional sensors, go to [buy.garmin.com](http://buy.garmin.com).

### Pairing Your Wireless Sensors

The first time you connect a wireless sensor to your device using ANT+ or Bluetooth technology, you must pair the device and sensor. After they are paired, the device connects to the sensor automatically when you start an activity and the sensor is active and within range.

- 1 If you are pairing a heart rate monitor, put on the heart rate monitor.  
The heart rate monitor does not send or receive data until you put it on.
- 2 Bring the device within 3 m (10 ft.) of the sensor.  
**NOTE:** Stay 10 m (33 ft.) away from other wireless sensors while pairing.
- 3 Hold **MENU**.
- 4 Select **Sensors & Accessories > Add New**.
- 5 Select an option:
  - Select **Search All Sensors**.
  - Select your sensor type.

After the sensor is paired with your device, the sensor status changes from Searching to Connected. Sensor data appears in the data screen loop or a custom data field.

### HRM-Pro

Your device is compatible with the HRM-Pro accessory. The HRM-Pro accessory is a chest heart rate monitor that you can pair with compatible devices using ANT+ and Bluetooth technology. You can wear the heart rate monitor to record heart rate data and receive real-time feedback on your running form (*Running Dynamics*, page 42). The heart rate monitor's activity tracking feature records your step count, calories, intensity minutes, and all-day heart rate. You must pair the heart rate monitor with your device to view your heart rate data. See the instructions for your HRM-Pro accessory for more information ([garmin.com/manuals/hrm-pro](http://garmin.com/manuals/hrm-pro)).

### Extended Display Mode

You can use Extended Display mode to display data screens from your MARQ device on a compatible Edge device during a ride or triathlon. See your Edge owner's manual for more information.

## Using an Optional Bike Speed or Cadence Sensor

You can use a compatible bike speed or cadence sensor to send data to your device.

- Pair the sensor with your device ([Pairing Your Wireless Sensors, page 105](#)).
- Set your wheel size ([Wheel Size and Circumference, page 124](#)).
- Go for a ride ([Starting an Activity, page 11](#)).

## Training with Power Meters

- Go to [www.garmin.com/intosports](http://www.garmin.com/intosports) for a list of ANT+ sensors that are compatible with your device (such as Rally™ and Vector™).
- For more information, see the owner's manual for your power meter.
- Adjust your power zones to match your goals and abilities ([Setting Your Power Zones, page 58](#)).
- Use range alerts to be notified when you reach a specified power zone ([Setting an Alert, page 87](#)).
- Customize the power data fields ([Customizing the Data Screens, page 85](#)).

## Using Electronic Shifters

Before you can use compatible electronic shifters, such as Shimano® Di2™ shifters, you must pair them with your device ([Pairing Your Wireless Sensors, page 105](#)). You can customize the optional data fields ([Customizing the Data Screens, page 85](#)). The MARQ device displays current adjustment values when the sensor is in adjustment mode.

## Situational Awareness

Your MARQ device can be used with the Varia™ smart bike lights and rearview radar to improve situational awareness. See the owner's manual for your Varia device for more information.

**NOTE:** You may need to update the MARQ software before pairing Varia devices ([Updating the Software Using the Garmin Connect App, page 30](#)).

## Foot Pod

Your device is compatible with the foot pod. You can use the foot pod to record pace and distance instead of using GPS when you are training indoors or when your GPS signal is weak. The foot pod is on standby and ready to send data (like the heart rate monitor).

After 30 minutes of inactivity, the foot pod powers off to conserve the battery. When the battery is low, a message appears on your device. Approximately five hours of battery life remain.

## Improving Foot Pod Calibration

Before you can calibrate your device, you must acquire GPS signals and pair your device with the foot pod ([Pairing Your Wireless Sensors, page 105](#)).

The foot pod is self-calibrating, but you can improve the accuracy of the speed and distance data with a few outdoor runs using GPS.

- 1 Stand outside for 5 minutes with a clear view of the sky.
- 2 Start a running activity.
- 3 Run on a track without stopping for 10 minutes.
- 4 Stop your activity, and save it.

Based on the recorded data, the foot pod calibration value changes, if necessary. You should not need to calibrate the foot pod again unless your running style changes.

## Calibrating Your Foot Pod Manually

Before you can calibrate your device, you must pair your device with the foot pod sensor ([Pairing Your Wireless Sensors, page 105](#)).

Manual calibration is recommended if you know your calibration factor. If you have calibrated a foot pod with another Garmin product, you may know your calibration factor.

- 1 Hold **MENU**.
- 2 Select **Sensors & Accessories**.
- 3 Select your foot pod.
- 4 Select **Cal. Factor > Set Value**.
- 5 Adjust the calibration factor:
  - Increase the calibration factor if your distance is too low.
  - Decrease the calibration factor if your distance is too high.

## Setting Foot Pod Speed and Distance

Before you can customize the foot pod speed and distance, you must pair your device with the foot pod sensor ([Pairing Your Wireless Sensors, page 105](#)).

You can set your device to calculate speed and distance using your foot pod data instead of GPS data.

- 1 Hold **MENU**.
- 2 Select **Sensors & Accessories**.
- 3 Select your foot pod.
- 4 Select **Speed or Distance**.
- 5 Select an option:
  - Select **Indoor** when you are training with GPS turned off, usually indoors.
  - Select **Always** to use your foot pod data regardless of the GPS setting.

## tempe

Your device is compatible with the tempe temperature sensor. You can attach the sensor to a secure strap or loop where it is exposed to ambient air, so it provides a consistent source of accurate temperature data. You must pair the tempe sensor with your device to display temperature data. See the instructions for your tempe sensor for more information ([garmin.com/manuals/tempe](http://garmin.com/manuals/tempe)).

## Club Sensors

Your device is compatible with Approach CT10 golf club sensors. You can use paired club sensors to automatically track your golf shots, including location, distance, and club type. See the owner's manual for your club sensors for more information ([garmin.com/manuals/ApproachCT10](http://garmin.com/manuals/ApproachCT10)).

# Device Information

## Specifications

Battery type	Rechargeable, built-in lithium-ion battery
Battery life	Up to 12 days (smartwatch mode with activity tracking and 24/7 wrist-based heart rate monitoring)
Water rating	10 ATM <sup>1</sup>
Operating and storage temperature range	From -20° to 45°C (from -4° to 113°F)
Charging temperature range	From 0° to 45°C (from 32° to 113°F)
Wireless frequencies	2.4 GHz @ 19 dBm nominal, 13.56 MHz @ -36 dBm nominal

## Battery Information

The actual battery life depends on the features enabled on your device, such as activity tracking, wrist-based heart rate, smartphone notifications, GPS, internal sensors, and connected sensors.

Battery Life	Mode
Up to 12 days	Smartwatch mode with activity tracking and 24/7 wrist-based heart rate monitoring
Up to 28 hours	GPS mode with wrist-based heart rate
Up to 9 hours	GPS mode with wrist-based heart rate and streaming music
Up to 48 hours	UltraTrac GPS mode with gyro-based dead reckoning (with wrist-based heart rate monitoring turned off)

## Data Management

**NOTE:** The device is not compatible with Windows 95, 98, Me, Windows NT®, and Mac® OS 10.3 and earlier.

## Deleting Files

### NOTICE

If you do not know the purpose of a file, do not delete it. Your device memory contains important system files that should not be deleted.

- 1 Open the **Garmin** drive or volume.
- 2 If necessary, open a folder or volume.
- 3 Select a file.
- 4 Press the **Delete** key on your keyboard.

**NOTE:** Mac operating systems provide limited support for MTP file transfer mode. You must open the Garmin drive on a Windows operating system. You should use the Garmin Express application to remove music files from your device.

<sup>1</sup> The device withstands pressure equivalent to a depth of 100 m. For more information, go to [www.garmin.com/waterrating](http://www.garmin.com/waterrating).

# Device Maintenance

## Device Care

### NOTICE

Do not use a sharp object to clean the device.

Avoid chemical cleaners, solvents, and insect repellents that can damage plastic components and finishes.

Thoroughly rinse the device with fresh water after exposure to chlorine, salt water, sunscreen, cosmetics, alcohol, or other harsh chemicals. Prolonged exposure to these substances can damage the case.

Avoid pressing the keys under water.

Avoid extreme shock and harsh treatment, because it can degrade the life of the product.

Do not store the device where prolonged exposure to extreme temperatures can occur, because it can cause permanent damage.

## Cleaning the Device

### NOTICE

Even small amounts of sweat or moisture can cause corrosion of the electrical contacts when connected to a charger. Corrosion can prevent charging and data transfer.

- 1 Wipe the device using a cloth dampened with a mild detergent solution.
- 2 Wipe it dry.

After cleaning, allow the device to dry completely.

**TIP:** For more information, go to [www.garmin.com/fitandcare](http://www.garmin.com/fitandcare).

## Changing Integrated QuickFit® Accessories

- 1 Pull to open the latch, and remove the integrated QuickFit strap or bracelet from the watch.



- 2 Pull to open the latch on the integrated strap or bracelet, and align it with the watch.
- 3 Close the latch over the watch pin.

**NOTE:** Make sure the strap or bracelet is secure. There should be a small gap ① between the latch and the strap or bracelet.



## Tips for Adjusting the Metal Bracelet

Garmin recommends you take your watch to a jeweler or other professional to adjust the length of the metal bracelet.

- Use a small screwdriver to unscrew the links.

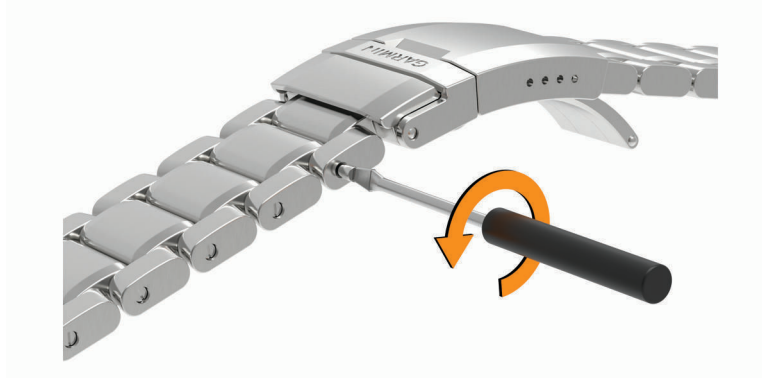

- Remove an equal number of links from both sides of the clasp. This helps your watch stay centered on your wrist.
- Use a pin removal tool to reposition the spring bar in the clasp for finer size adjustment. Use caution when making size adjustments to the clasp. The pin is compressed, and can move unexpectedly when released.



## Troubleshooting

### My device is in the wrong language

You can change the device language selection if you have accidentally selected the wrong language on the device.

- 1 Hold **MENU**.
- 2 Scroll down to the last item in the list, and press **START**.
- 3 Press **START**.
- 4 Select your language.



## Is my smartphone compatible with my device?

The MARQ device is compatible with smartphones using Bluetooth technology.

Go to [www.garmin.com/ble](http://www.garmin.com/ble) for compatibility information.

## My phone will not connect to the device

If your phone will not connect to the device, you can try these tips.

- Turn off your smartphone and your device, and turn them back on again.
- Enable Bluetooth technology on your smartphone.
- Update the Garmin Connect app to the latest version.
- Remove your device from the Garmin Connect app and the Bluetooth settings on your smartphone to retry the pairing process.
- If you bought a new smartphone, remove your device from the Garmin Connect app on the smartphone you intend to stop using.
- Bring your smartphone within 10 m (33 ft.) of the device.
- On your smartphone, open the Garmin Connect app, select  or , and select **Garmin Devices > Add Device** to enter pairing mode.
- From the watch face, hold **MENU**, and select **Phone > Pair Phone**.

## Can I use my Bluetooth sensor with my watch?

The device is compatible with some Bluetooth sensors. The first time you connect a sensor to your Garmin device, you must pair the device and sensor. After they are paired, the device connects to the sensor automatically when you start an activity and the sensor is active and within range.

- 1 Hold **MENU**.
- 2 Select **Sensors & Accessories > Add New**.
- 3 Select an option:
  - Select **Search All Sensors**.
  - Select your sensor type.

You can customize the optional data fields (*Customizing the Data Screens, page 85*).

## My headphones will not connect to the device

If your headphones were previously connected to your smartphone using Bluetooth technology, they may connect to your smartphone before connecting to your device. You can try these tips.

- Turn off Bluetooth technology on your smartphone.  
Refer to the owner's manual for your smartphone for more information.
- Stay 10 m (33 ft.) away from your smartphone while connecting headphones to your device.
- Pair your headphones with your device (*Connecting Bluetooth Headphones, page 39*).

## My music cuts out or my headphones do not stay connected

When using a MARQ device connected to headphones using Bluetooth technology, the signal is strongest when there is a direct line of sight between the device and the antenna on the headphones.

- If the signal passes through your body, you may experience signal loss or your headphones may become disconnected.
- It is recommended to wear your headphones with the antenna on the same side of your body as your MARQ device.
- Since headphones vary by model, you can try moving the watch to your other wrist.

## Restarting Your Device

- 1 Hold **LIGHT** until the device turns off.
- 2 Hold **LIGHT** to turn on the device.

## Resetting All Default Settings

You can reset all of the device settings to the factory default values.

- 1 Hold **MENU**.
- 2 Select **System > Reset**.
- 3 Select an option:
  - To reset all of the device settings to the factory default values and save all user-entered information and activity history, select **Reset Default Settings**.
  - To delete all activities from the history, select **Delete All Activities**.
  - To reset all distance and time totals, select **Reset Totals**.
  - To reset all of the device settings to the factory default values and delete all user-entered information and activity history, select **Delete Data and Reset Settings**.

**NOTE:** If you have set up a Garmin Pay wallet, this option deletes the wallet from your device. If you have music stored on your device, this option deletes your stored music.

## Acquiring Satellite Signals

The device may need a clear view of the sky to acquire satellite signals. The time and date are set automatically based on the GPS position.

**TIP:** For more information about GPS, go to [www.garmin.com/aboutGPS](http://www.garmin.com/aboutGPS).

- 1 Go outdoors to an open area.  
The watch should be oriented with 6 o'clock pointing toward the sky.
- 2 Wait while the device locates satellites.  
It may take 30 to 60 seconds to locate satellite signals.

## Improving GPS Satellite Reception

- Frequently sync the device to your Garmin Connect account:
  - Connect your device to a computer using the USB cable and the Garmin Express application.
  - Sync your device to the Garmin Connect app using your Bluetooth enabled smartphone.
  - Connect your device to your Garmin Connect account using a Wi-Fi wireless network.

While connected to your Garmin Connect account, the device downloads several days of satellite data, allowing it to quickly locate satellite signals.

- Take your device outside to an open area away from tall buildings and trees.
- Remain stationary for a few minutes.

## The temperature reading is not accurate

Your body temperature affects the temperature reading for the internal temperature sensor. To get the most accurate temperature reading, you should remove the watch from your wrist and wait 20 to 30 minutes.

You can also use an optional temperature external temperature sensor to view accurate ambient temperature readings while wearing the watch.



## Maximizing the Battery Life

You can do several things to extend the life of the battery.

- Change the power mode during an activity (*Changing the Power Mode*, page 11).
- Turn on the battery saver feature from the controls menu (*Viewing the Controls Menu*, page 2).
- Reduce the backlight timeout (*Changing the Backlight Settings*, page 104).
- Reduce the backlight brightness.
- Use UltraTrac GPS mode for your activity (*UltraTrac*, page 90).
- Turn off Bluetooth technology when you are not using connected features (*Connected Features*, page 27).
- When pausing your activity for a longer period of time, use the resume later option (*Stopping an Activity*, page 12).
- Turn off activity tracking (*Turning Off Activity Tracking*, page 60).
- Use a watch face that is not updated every second.  
For example, use a watch face without a second hand (*Customizing the Watch Face*, page 98).
- Limit the smartphone notifications the device displays (*Managing Notifications*, page 29).
- Stop broadcasting heart rate data to paired Garmin devices (*Broadcasting Heart Rate Data to Garmin Devices*, page 41).
- Turn off wrist-based heart rate monitoring (*Turning Off the Wrist-based Heart Rate Monitor*, page 42).  
**NOTE:** Wrist-based heart rate monitoring is used to calculate vigorous intensity minutes and calories burned.
- Turn on manual pulse oximeter readings (*Turning Off Automatic Pulse Oximeter Readings*, page 56).

## Activity Tracking

For more information about activity tracking accuracy, go to [garmin.com/ataccuracy](https://garmin.com/ataccuracy).

### My daily step count does not appear

The daily step count is reset every night at midnight.

If dashes appear instead of your step count, allow the device to acquire satellite signals and set the time automatically.

### My step count does not seem accurate

If your step count does not seem accurate, you can try these tips.

- Wear the device on your non-dominant wrist.
- Carry the device in your pocket when pushing a stroller or lawn mower.
- Carry the device in your pocket when actively using your hands or arms only.

**NOTE:** The device may interpret some repetitive motions, such as washing dishes, folding laundry, or clapping your hands, as steps.

### The step counts on my device and my Garmin Connect account don't match

The step count on your Garmin Connect account updates when you sync your device.

1 Select an option:

- Sync your step count with the Garmin Express application (*Using Garmin Connect on Your Computer*, page 31).
- Sync your step count with the Garmin Connect app (*Manually Syncing Data with Garmin Connect*, page 31).

2 Wait while the device syncs your data.

Syncing can take several minutes.

**NOTE:** Refreshing the Garmin Connect app or the Garmin Express application does not sync your data or update your step count.

## The floors climbed amount does not seem accurate

Your device uses an internal barometer to measure elevation changes as you climb floors. A floor climbed is equal to 3 m (10 ft.).

- Avoid holding handrails or skipping steps while climbing stairs.
- In windy environments, cover the device with your sleeve or jacket as strong gusts can cause erratic readings.

## Getting More Information

You can find more information about this product on the Garmin website.

- Go to [support.garmin.com](https://support.garmin.com) for additional manuals, articles, and software updates.
- Go to [buy.garmin.com](https://buy.garmin.com), or contact your Garmin dealer for information about optional accessories and replacement parts.
- Go to [www.garmin.com/ataccuracy](https://www.garmin.com/ataccuracy) for information about feature accuracy.

This is not a medical device.



# Appendix

## Data Fields

**NOTE:** Not all data fields are available for all activity types. Some data fields require ANT+ or Bluetooth accessories to display data.

**% Functional Threshold Power:** The current power output as a percentage of functional threshold power.

**% Heart Rate Reserve:** The percentage of heart rate reserve (maximum heart rate minus resting heart rate).

**10s Balance:** The 10-second moving average of the left/right power balance.

**10s Power:** The 10-second moving average of power output.

**24-Hour Maximum:** The maximum temperature recorded in the last 24 hours from a compatible temperature sensor.

**24-Hour Minimum:** The minimum temperature recorded in the last 24 hours from a compatible temperature sensor.

**30s Balance:** The 30-second moving average of the left/right power balance.

**30s Power:** The 30-second moving average of power output.

**3s Balance:** The three-second moving average of the left/right power balance.

**3s Power:** The 3-second moving average of power output.

**500m Pace:** The current rowing pace per 500 meters.

**Aerobic Training Effect:** The impact of the current activity on your aerobic fitness level.

**Ambient Pressure:** The uncalibrated environmental pressure.

**Anaerobic Training Effect:** The impact of the current activity on your anaerobic fitness level.

**Average % Heart Rate Reserve:** The average percentage of heart rate reserve (maximum heart rate minus resting heart rate) for the current activity.

**Average 500m Pace:** The average rowing pace per 500 meters for the current activity.

**Average Ascent:** The average vertical distance of ascent since the last reset.

**Average Balance:** The average left/right power balance for the current activity.

**Average Cadence:** Cycling. The average cadence for the current activity.

**Average Cadence:** Running. The average cadence for the current activity.

**Average Descent:** The average vertical distance of descent since the last reset.

**Average Distance Per Stroke:** Swimming. The average distance traveled per stroke during the current activity.

**Average Distance Per Stroke:** Paddle sports. The average distance traveled per stroke during the current activity.

**Average GCT Balance:** The average ground contact time balance for the current session.

**Average Ground Contact Time:** The average amount of ground contact time for the current activity.

**Average Heart Rate:** The average heart rate for the current activity.

**Average Heart Rate %Max.:** The average percentage of maximum heart rate for the current activity.

**Average Lap Time:** The average lap time for the current activity.

**Average Left Power Phase:** The average power phase angle for the left leg for the current activity.

**Average Moving Speed:** The average speed when moving for the current activity.

**Average Nautical Speed:** The average speed in knots for the current activity.

**Average Overall Speed:** The average speed for the current activity, including both moving and stopped speeds.

**Average Pace:** The average pace for the current activity.

**Average Power:** The average power output for the current activity.

**Average Right Power Phase:** The average power phase angle for the right leg for the current activity.

**Average Speed:** The average speed for the current activity.

**Average Stride Length:** The average stride length for the current session.

**Average Stroke Rate:** Paddle sports. The average number of strokes per minute (spm) during the current activity.

**Average Strokes Per Length:** The average number of strokes per pool length during the current activity.

**Average Swolf:** The average swolf score for the current activity. Your swolf score is the sum of the time for one length plus the number of strokes for that length (*Swim Terminology, page 19*). In open water swimming, 25 meters is used to calculate your swolf score.

**Average Vertical Oscillation:** The average amount of vertical oscillation for the current activity.

**Average Vertical Ratio:** The average ratio of vertical oscillation to stride length for the current session.

**Avg. Left Peak Power Phase:** The average power phase peak angle for the left leg for the current activity.

**Avg. Nautical SOG:** The average speed of travel in knots for the current activity, regardless of the course steered and temporary variations in heading.

**Avg. Platform Center Offset:** The average platform center offset for the current activity.

**Avg. Right Peak Power Phase:** The average power phase peak angle for the right leg for the current activity.

**Avg. SOG:** The average speed of travel for the current activity, regardless of the course steered and temporary variations in heading.

**Balance:** The current left/right power balance.

**Barometric Pressure:** The current calibrated environmental pressure.

**Battery Hours:** The number of hours remaining before the battery power is depleted.

**Battery Percentage:** The percentage of the battery power remaining.

**Bearing:** The direction from your current location to a destination. You must be navigating for this data to appear.

**Cadence:** Cycling. The number of revolutions of the crank arm. Your device must be connected to a cadence accessory for this data to appear.

**Cadence:** Running. The steps per minute (right and left).

**Cadence Gauge:** Running. A color gauge showing your current cadence range.

**Calories:** The amount of total calories burned.

**COG:** The actual direction of travel, regardless of the course steered and temporary variations in heading.

**Compass Gauge:** The direction you are moving based on the compass.

**Compass Heading:** The direction you are moving based on the compass.

**Course:** The direction from your starting location to a destination. Course can be viewed as a planned or set route. You must be navigating for this data to appear.

**Destination Location:** The position of your final destination.

**Destination Waypoint:** The last point on the route to the destination. You must be navigating for this data to appear.

**Di2 Battery:** The remaining battery power of a Di2 sensor.

**Distance:** The distance traveled for the current track or activity.

**Distance Per Stroke:** Paddle sports. The distance traveled per stroke.

**Distance Remaining:** The remaining distance to the final destination. You must be navigating for this data to appear.

**Distance To Next:** The remaining distance to the next waypoint on the route. You must be navigating for this data to appear.

**Elapsed Time:** The total time recorded. For example, if you start the timer and run for 10 minutes, then stop the timer for 5 minutes, then start the timer and run for 20 minutes, your elapsed time is 35 minutes.

**Elevation:** The altitude of your current location above or below sea level.

**Estimated Total Distance:** The estimated distance from the start to the final destination. You must be navigating for this data to appear.

**ETA:** The estimated time of day when you will reach the final destination (adjusted to the local time of the destination). You must be navigating for this data to appear.



**ETA at Next:** The estimated time of day when you will reach the next waypoint on the route (adjusted to the local time of the waypoint). You must be navigating for this data to appear.

**ETE:** The estimated time remaining until you reach the final destination. You must be navigating for this data to appear.

**Floors Climbed:** The total number of floors climbed up for the day.

**Floors Descended:** The total number of floors climbed down for the day.

**Floors per Minute:** The number of floors climbed up per minute.

**Flow:** The measurement of how consistently you maintain speed and smoothness through turns in the current activity.

**Front:** The front bike gear from a gear position sensor.

**GCT Balance:** The left/right balance of ground contact time while running.

**GCT Balance Gauge:** A color gauge showing the left/right balance of ground contact time while running.

**Gear Battery:** The battery status of a gear position sensor.

**Gear Combo:** The current gear combination from a gear position sensor.

**Gear Ratio:** The number of teeth on the front and rear bike gears, as detected by a gear position sensor.

**Gears:** The front and rear bike gears from a gear position sensor.

**Glide Ratio:** The ratio of horizontal distance traveled to the change in vertical distance.

**Glide Ratio to Destination:** The glide ratio required to descend from your current position to the destination elevation. You must be navigating for this data to appear.

**GPS:** The strength of the GPS satellite signal.

**GPS Elevation:** The altitude of your current location using GPS.

**GPS Heading:** The direction you are moving based on GPS.

**Grade:** The calculation of rise (elevation) over run (distance). For example, if for every 3 m (10 ft.) you climb you travel 60 m (200 ft.), the grade is 5%.

**Grit:** The measurement of difficulty for the current activity based on elevation, gradient, and rapid changes in direction.

**Ground Contact Time:** The amount of time in each step that you spend on the ground while running, measured in milliseconds. Ground contact time is not calculated while walking.

**Ground Contact Time Gauge:** A color gauge showing the amount of time in each step that you spend on the ground while running, measured in milliseconds.

**Heading:** The direction you are moving.

**Heart Rate:** Your heart rate in beats per minute (bpm). Your device must have wrist-based heart rate or be connected to a compatible heart rate monitor.

**Heart Rate %Max.:** The percentage of maximum heart rate.

**Heart Rate Gauge:** A color gauge showing your current heart rate zone.

**Heart Rate Zone:** The current range of your heart rate (1 to 5). The default zones are based on your user profile and maximum heart rate (220 minus your age).

**Intensity Factor:** The Intensity Factor™ for the current activity.

**Interval Average %HRR:** The average percentage of heart rate reserve (maximum heart rate minus resting heart rate) for the current swim interval.

**Interval Average %Max.:** The average percentage of maximum heart rate for the current swim interval.

**Interval Average Heart Rate:** The average heart rate for the current swim interval.

**Interval Distance:** The distance traveled for the current interval.

**Interval Lengths:** The number of pool lengths completed during the current interval.

**Interval Maximum %HRR:** The maximum percentage of heart rate reserve (maximum heart rate minus resting heart rate) for the current swim interval.

**Interval Maximum %Max.:** The maximum percentage of maximum heart rate for the current swim interval.

**Interval Maximum Heart Rate:** The maximum heart rate for the current swim interval.

**Interval Pace:** The average pace for the current interval.

**Interval Stroke Rate:** The average number of strokes per minute (spm) during the current interval.

**Interval Strokes Per Length:** The average number of strokes per pool length during the current interval.

**Interval Stroke Type:** The current stroke type for the interval.

**Interval Swolf:** The average swolf score for the current interval.

**Interval Time:** The stopwatch time for the current interval.

**Lap % Heart Rate Reserve:** The average percentage of heart rate reserve (maximum heart rate minus resting heart rate) for the current lap.

**Lap 500m Pace:** The average rowing pace per 500 meters for the current lap.

**Lap Ascent:** The vertical distance of ascent for the current lap.

**Lap Balance:** The average left/right power balance for the current lap.

**Lap Cadence:** Cycling. The average cadence for the current lap.

**Lap Cadence:** Running. The average cadence for the current lap.

**Lap Descent:** The vertical distance of descent for the current lap.

**Lap Distance:** The distance traveled for the current lap.

**Lap Distance Per Stroke:** Swimming. The average distance traveled per stroke during the current lap.

**Lap Distance Per Stroke:** Paddle sports. The average distance traveled per stroke during the current lap.

**Lap Flow:** The overall flow score for the current lap.

**Lap GCT Balance:** The average ground contact time balance for the current lap.

**Lap Grit:** The overall grit score for the current lap.

**Lap Ground Contact Time:** The average amount of ground contact time for the current lap.

**Lap Heart Rate:** The average heart rate for the current lap.

**Lap Heart Rate %Max.:** The average percentage of maximum heart rate for the current lap.

**Lap Left Peak Power Phase:** The average power phase peak angle for the left leg for the current lap.

**Lap Left Power Phase:** The average power phase angle for the left leg for the current lap.

**Lap Normalized Power:** The average Normalized Power for the current lap.

**Lap Pace:** The average pace for the current lap.

**Lap Platform Center Offset:** The average platform center offset for the current lap.

**Lap Power:** The average power output for the current lap.

**Lap Right Peak Power Phase:** The average power phase peak angle for the right leg for the current lap.

**Lap Right Power Phase:** The average power phase angle for the right leg for the current lap.

**Laps:** The number of laps completed for the current activity.

**Lap SOG:** The average speed of travel for the current lap, regardless of the course steered and temporary variations in heading.

**Lap Speed:** The average speed for the current lap.

**Lap Stride Length:** The average stride length for the current lap.

**Lap Stroke Rate:** Swimming. The average number of strokes per minute (spm) during the current lap.

**Lap Stroke Rate:** Paddle sports. The average number of strokes per minute (spm) during the current lap.

**Lap Strokes:** Swimming. The total number of strokes for the current lap.

**Lap Strokes:** Paddle sports. The total number of strokes for the current lap.

**Lap Swolf:** The swolf score for the current lap.

**Lap Time:** The stopwatch time for the current lap.

**Lap Vertical Oscillation:** The average amount of vertical oscillation for the current lap.

**Lap Vertical Ratio:** The average ratio of vertical oscillation to stride length for the current lap.

**Last Lap %HRR:** The average percentage of heart rate reserve (maximum heart rate minus resting heart rate) for the last completed lap.



**Last Lap 500m Pace:** The average rowing pace per 500 meters for the last lap.

**Last Lap Ascent:** The vertical distance of ascent for the last completed lap.

**Last Lap Cadence:** Cycling. The average cadence for the last completed lap.

**Last Lap Cadence:** Running. The average cadence for the last completed lap.

**Last Lap Descent:** The vertical distance of descent for the last completed lap.

**Last Lap Distance:** The distance traveled for the last completed lap.

**Last Lap Distance Per Stroke:** Swimming. The average distance traveled per stroke during the last completed lap.

**Last Lap Distance Per Stroke:** Paddle sports. The average distance traveled per stroke during the last completed lap.

**Last Lap Heart Rate:** The average heart rate for the last completed lap.

**Last Lap Heart Rate %Max.:** The average percentage of maximum heart rate for the last completed lap.

**Last Lap Max. Power:** The top power output for the last completed lap.

**Last Lap Normalized Power:** The average Normalized Power for the last completed lap.

**Last Lap Pace:** The average pace for the last completed lap.

**Last Lap Power:** The average power output for the last completed lap.

**Last Lap SOG:** The average speed of travel for the last completed lap, regardless of the course steered and temporary variations in heading.

**Last Lap Speed:** The average speed for the last completed lap.

**Last Lap Stroke Rate:** Swimming. The average number of strokes per minute (spm) during the last completed lap.

**Last Lap Stroke Rate:** Paddle sports. The average number of strokes per minute (spm) during the last completed lap.

**Last Lap Strokes:** Swimming. The total number of strokes for the last completed lap.

**Last Lap Strokes:** Paddle sports. The total number of strokes for the last completed lap.

**Last Lap Swolf:** The swolf score for the last completed lap.

**Last Lap Time:** The stopwatch time for the last completed lap.

**Last Length Pace:** The average pace for your last completed pool length.

**Last Length Stroke Rate:** The average number strokes per minute (spm) during the last completed pool length.

**Last Length Strokes:** The total number of strokes for the last completed pool length.

**Last Length Stroke Type:** The stroke type used during the last completed pool length.

**Last Length Swolf:** The swolf score for the last completed pool length.

**Lat/Lon:** The current position in latitude and longitude regardless of the selected position format setting.

**Left Peak Power Phase:** The current power phase peak angle for the left leg. Power phase peak is the angle range over which the rider produces the peak portion of the driving force.

**Left Power Phase:** The current power phase angle for the left leg. Power phase is the pedal stroke region where positive power is produced.

**Lengths:** The number of pool lengths completed during the current activity.

**Load:** The training load for the current activity. Training load is the amount of excess post-exercise oxygen consumption (EPOC), which indicates the strenuousness of your workout.

**Location:** The current position using the selected position format setting.

**Max. Nautical SOG:** The maximum speed of travel in knots for the current activity, regardless of the course steered and temporary variations in heading.

**Maximum Ascent:** The maximum rate of ascent in feet per minute or meters per minute since the last reset.

**Maximum Descent:** The maximum rate of descent in meters per minute or feet per minute since the last reset.

**Maximum Elevation:** The highest elevation reached since the last reset.

**Maximum Lap Power:** The top power output for the current lap.

**Maximum Nautical Speed:** The maximum speed in knots for the current activity.

**Maximum Power:** The top power output for the current activity.

**Maximum SOG:** The maximum speed of travel for the current activity, regardless of the course steered and temporary variations in heading.

**Maximum Speed:** The top speed for the current activity.

**Minimum Elevation:** The lowest elevation reached since the last reset.

**Moving Time:** The total time moving for the current activity.

**Multisport Time:** The total time for all sports in a multisport activity, including transitions.

**Muscle O2 Saturation %:** The estimated muscle oxygen saturation percentage for the current activity.

**Nautical Distance:** The distance traveled in nautical meters or nautical feet.

**Nautical SOG:** The actual speed of travel in knots, regardless of the course steered and temporary variations in heading.

**Nautical Speed:** The current speed in knots.

**Next Split Distance:** Running. The total distance of the next split.

**Next Split Target Pace:** Running. The target pace for the next split.

**Next Waypoint:** The next point on the route. You must be navigating for this data to appear.

**Normalized Power:** The Normalized Power™ for the current activity.

**Off Course:** The distance to the left or right by which you have strayed from the original path of travel. You must be navigating for this data to appear.

**Overall Ahead/Behind:** Running. The overall time ahead or behind of the target pace.

**Pace:** The current pace.

**PacePro Gauge:** Running. Your current split pace and your target split pace.

**Pedal Smoothness:** The measurement of how evenly a rider is applying force to the pedals throughout each pedal stroke.

**Performance Condition:** The performance condition score is a real-time assessment of your ability to perform.

**Platform Center Offset:** The platform center offset. Platform center offset is the location on the pedal platform where force is applied.

**Power:** Cycling. The current power output in watts.

**Power:** Skiing. The current power output in watts. Your device must be connected to a compatible heart rate monitor.

**Power Gauge:** A color gauge showing your current power zone.

**Power to Weight:** The current power measured in watts per kilogram.

**Power Zone:** The current range of power output (1 to 7) based on your FTP or custom settings.

**Rear:** The rear bike gear from a gear position sensor.

**Repeat On:** The timer for the last interval plus the current rest (pool swimming).

**Reps:** During a strength training activity, the number of repetitions in a workout set.

**Respiration Rate:** Your respiration rate in breaths per minute (brpm).

**Rest Timer:** The timer for the current rest (pool swimming).

**Right Peak Power Phase:** The current power phase peak angle for the right leg. Power phase peak is the angle range over which the rider produces the peak portion of the driving force.

**Right Power Phase:** The current power phase angle for the right leg. Power phase is the pedal stroke region where positive power is produced.

**Set Timer:** During a strength training activity, the amount of time spent in the current workout set.

**Speed:** The current rate of travel.

**Speed Over Ground:** The actual speed of travel, regardless of the course steered and temporary variations in heading.

**Split Distance:** Running. The total distance of the current split.



**Split Distance Remaining:** Running. The remaining distance of the current split.

**Split Pace:** Running. The pace for the current split.

**Split Target Pace:** Running. The target pace for the current split.

**Steps:** The number of steps taken during the current activity.

**Stopped Time:** The total time stopped for the current activity.

**Stress:** Your current stress level.

**Stride Length:** The length of your stride from one footfall to the next, measured in meters.

**Stroke Rate:** Swimming. The number of strokes per minute (spm).

**Stroke Rate:** Paddle sports. The number of strokes per minute (spm).

**Strokes:** Swimming. The total number of strokes for the current activity.

**Strokes:** Paddle sports. The total number of strokes for the current activity.

**Sunrise:** The time of sunrise based on your GPS position.

**Sunset:** The time of sunset based on your GPS position.

**Swim Time:** The swimming time for the current activity, not including rest time.

**Temperature:** The temperature of the air. Your body temperature affects the temperature sensor. You can pair a temperature sensor with your device to provide a consistent source of accurate temperature data.

**Time in Zone:** The time elapsed in each heart rate or power zone.

**Time of Day:** The time of day based on your current location and time settings (format, time zone, daylight saving time).

**Time of Day (Seconds):** The time of day including seconds.

**Timer:** The current time of the countdown timer.

**Time Seated:** The time spent seated while pedaling for the current activity.

**Time Seated Lap:** The time spent seated while pedaling for the current lap.

**Time Standing:** The time spent standing while pedaling for the current activity.

**Time Standing Lap:** The time spent standing while pedaling for the current lap.

**Time to Next:** The estimated time remaining before you reach the next waypoint in the route. You must be navigating for this data to appear.

**Torque Efficiency:** The measurement of how efficiently a rider is pedaling.

**Total Ascent:** The total elevation distance ascended since the last reset.

**Total Ascent/Descent Gauge:** The total elevation distances ascended and descended during the activity or since the last reset.

**Total Descent:** The total elevation distance descended since the last reset.

**Total Hemoglobin:** The estimated total hemoglobin concentration in the muscle.

**Training Effect Gauge:** The impact of the current activity on your aerobic and anaerobic fitness levels.

**Training Stress Score:** The Training Stress Score™ for the current activity.

**Velocity Made Good:** The speed at which you are closing on a destination along a route. You must be navigating for this data to appear.

**Vertical Dist. to Dest.:** The elevation distance between your current position and the final destination. You must be navigating for this data to appear.

**Vertical Oscillation:** The amount of bounce while you are running. The vertical motion of your torso, measured in centimeters for each step.

**Vertical Oscillation Gauge:** A color gauge showing the amount of bounce while you are running.

**Vertical Ratio:** The ratio of vertical oscillation to stride length.

**Vertical Ratio Gauge:** A color gauge showing the ratio of vertical oscillation to stride length.

**Vertical Speed:** The rate of ascent or descent over time.

**Vertical Speed to Target:** The rate of ascent or descent to a predetermined altitude. You must be navigating for this data to appear.

**Work:** The accumulated work performed (power output) in kilojoules.

## V02 Max. Standard Ratings

These tables include standardized classifications for V02 max. estimates by age and gender.

Males	Percentile	20–29	30–39	40–49	50–59	60–69	70–79
Superior	95	55.4	54	52.5	48.9	45.7	42.1
Excellent	80	51.1	48.3	46.4	43.4	39.5	36.7
Good	60	45.4	44	42.4	39.2	35.5	32.3
Fair	40	41.7	40.5	38.5	35.6	32.3	29.4
Poor	0–40	<41.7	<40.5	<38.5	<35.6	<32.3	<29.4

Females	Percentile	20–29	30–39	40–49	50–59	60–69	70–79
Superior	95	49.6	47.4	45.3	41.1	37.8	36.7
Excellent	80	43.9	42.4	39.7	36.7	33	30.9
Good	60	39.5	37.8	36.3	33	30	28.1
Fair	40	36.1	34.4	33	30.1	27.5	25.9
Poor	0–40	<36.1	<34.4	<33	<30.1	<27.5	<25.9

Data reprinted with permission from The Cooper Institute. For more information, go to [www.CooperInstitute.org](http://www.CooperInstitute.org).

## FTP Ratings

These tables include classifications for functional threshold power (FTP) estimates by gender.

Males	Watts per Kilogram (W/kg)
Superior	5.05 and greater
Excellent	From 3.93 to 5.04
Good	From 2.79 to 3.92
Fair	From 2.23 to 2.78
Untrained	Less than 2.23

Females	Watts per Kilogram (W/kg)
Superior	4.30 and greater
Excellent	From 3.33 to 4.29
Good	From 2.36 to 3.32
Fair	From 1.90 to 2.35
Untrained	Less than 1.90

FTP ratings are based on research by Hunter Allen and Andrew Coggan, PhD, *Training and Racing with a Power Meter* (Boulder, CO: VeloPress, 2010).

## Wheel Size and Circumference

Your speed sensor automatically detects your wheel size. If necessary, you can manually enter your wheel circumference in the speed sensor settings.

The tire size is marked on both sides of the tire. This is not a comprehensive list. You can also measure the circumference of your wheel or use one of the calculators available on the internet.

Tire Size	Wheel Circumference (mm)
20 × 1.75	1515
20 × 1-3/8	1615
22 × 1-3/8	1770
22 × 1-1/2	1785
24 × 1	1753
24 × 3/4 Tubular	1785
24 × 1-1/8	1795
24 × 1.75	1890
24 × 1-1/4	1905
24 × 2.00	1925
24 × 2.125	1965
26 × 7/8	1920
26 × 1-1.0	1913
26 × 1	1952
26 × 1.25	1953
26 × 1-1/8	1970
26 × 1.40	2005
26 × 1.50	2010
26 × 1.75	2023
26 × 1.95	2050
26 × 2.00	2055
26 × 1-3/8	2068
26 × 2.10	2068
26 × 2.125	2070
26 × 2.35	2083
26 × 1-1/2	2100
26 × 3.00	2170
27 × 1	2145
27 × 1-1/8	2155







Tire Size	Wheel Circumference (mm)
27 x 1-1/4	2161
27 x 1-3/8	2169
29 x 2.1	2288
29 x 2.2	2298
29 x 2.3	2326
650 x 20C	1938
650 x 23C	1944
650 x 35A	2090
650 x 38B	2105
650 x 38A	2125
700 x 18C	2070
700 x 19C	2080
700 x 20C	2086
700 x 23C	2096
700 x 25C	2105
700C Tubular	2130
700 x 28C	2136
700 x 30C	2146
700 x 32C	2155
700 x 35C	2168
700 x 38C	2180
700 x 40C	2200
700 x 44C	2235
700 x 45C	2242
700 x 47C	2268



## Symbol Definitions

These symbols may appear on the device or accessory labels.

	Alternating current. The device is suitable for alternating current.
	Direct current. The device is suitable for direct current only.
	Fuse. Indicates a fuse specification or location.
	WEEE disposal and recycling symbol. The WEEE symbol is attached to the product in compliance with the EU directive 2012/19/EU on Waste Electrical and Electronic Equipment (WEEE). It is intended to deter the improper disposal of this product and to promote reuse and recycling.

# Index

## A

accessories **105, 106, 112, 115**  
acclimation **52**  
activities **5, 6, 11, 14, 15, 26, 27, 83, 91**  
    custom **13, 18, 61**  
    favorites **12**  
    saving **5, 6, 12**  
    starting **5, 6, 11**  
activity tracking **58–60**  
airport **3**  
    nearest **6**  
alarms **71, 86**  
alert **17**  
alerts **60, 86–88, 101, 104**  
    heart rate **42**  
altimeter **80, 99**  
    calibrating **5, 99**  
altitude **4, 52, 93**  
ANT+ sensors **105–107**  
    fitness equipment **14**  
applications **27, 31, 32, 34, 35**  
    smartphone **4**  
apps **13**  
assistance **32, 33**  
auto climb **89**  
Auto Lap **88**  
Auto Pause **89**  
auto rest **20**  
auto scroll **90**

## B

backlight **1, 104**  
bands **110, 111**  
barometer **80, 99**  
    calibrating **99**  
battery **109**  
    charging **3**  
    life **108**  
    maximizing **11, 29, 91, 102, 114**  
bike sensors **106**  
Bluetooth sensors **105**  
Bluetooth technology **17, 27–29, 32, 112**  
    headphones **39, 112**  
Body Battery **54**

## C

cadence **17, 42, 43**  
    alerts **87**  
    sensors **106**  
calendar **63**  
calibrating  
    altimeter **5, 99**  
    compass **98**  
calorie, alerts **87**  
charging **3**  
cleaning the device **109**  
clock **2, 71–73**  
compass **26, 80, 98, 99, 101**  
    calibrating **98**  
computer **38**  
Connect IQ **35**  
connecting **29, 35**  
contacts, adding **33**  
controls menu **2, 97**  
coordinates **74**  
countdown timer **71, 72**  
courses **76**  
    creating **74, 75**  
    editing **75**  
    playing **20, 21**  
    selecting **20**  
customizing the device **85, 97, 100, 104**

## D

data  
    pages **85**  
    sharing **105**  
    storing **30, 31**  
    transferring **30, 31**  
    uploading **31**  
data fields **35**  
database, updating **3**  
deleting  
    all user data **108**  
    history **82**  
    personal records **70**  
direct-to routing **7**  
distance **89**  
    alerts **87, 101**  
    measuring **22, 25**  
dogleg **23**  
drills **19, 20**

## E

elevation **52, 65**  
    settings **100**  
emergency contacts **32, 33**  
extended display **105**

## F

fitness **48**  
fitness age **47**  
flight plans **9–11, 32**  
foot pod **106, 107**

## G

Galileo **90**  
Garmin Connect **4, 27, 30–32, 34, 60, 61, 63, 65**  
    storing data **31**  
Garmin Express **4, 34**  
    updating software **4**  
Garmin Pay **35–37**  
Garmin Pilot **9, 10, 32**  
GLONASS **90, 103**  
goals **69**  
GPS **90, 103**  
    settings **90**  
    signal **113**  
green view **22**  
    pin location **23, 26**  
ground contact time **43, 44**  
GroupTrack **34**

## H

handicap **24**  
heading setting **101**  
headphones **112**  
    Bluetooth technology **39, 112**  
    connecting **39**  
heart rate **20, 40, 41, 47**  
    alerts **42, 87**  
    monitor **40, 42, 44, 46, 47, 53, 105**  
    pairing sensors **41**  
    zones **45, 57, 58, 81**  
history **80, 81**  
    deleting **82**  
    sending to computer **30, 31**  
holes, changing **22**

## I

incident detection **32, 33**  
indoor training **13, 14**  
inReach remote **95**  
intensity minutes **47, 60**  
intervals **19, 20**  
    workouts **64, 65**

## J

jumpmaster **18**

## K

keys **1, 103, 104**  
    customizing **89**

## L

lactate threshold **45, 49**  
language **103**  
laps **15**  
layout **23**  
lengths **19**  
LiveTrack **32, 34**  
locations **74**  
    deleting **73**  
    editing **73**  
    saving **73, 79**

## M

main menu, customizing **93**  
map **78–80, 87, 100, 101**  
    settings **100**  
map points. See points of interest (POI)  
maps **85, 101**  
    browsing **79**  
    navigating **77–79**  
    updating **4**  
marine **101**  
measurements **25**  
measuring a shot **23**  
menu **1**  
metronome **17**  
Move IQ **60**  
multisport **13, 18, 81**  
music **37–39**  
    loading **37, 38**  
    playing **39**  
    services **37, 38**  
music controls **39**

## N

navigation **6, 9, 74, 79, 80, 85, 101**  
    horizontal situation indicator (HSI) **8**  
    Sight 'N Go **76**  
    stopping **9, 78**  
    waypoints **7**  
nearest airport **6, 7**  
NFC **36**  
north reference **99**  
notifications **28, 29**  
    phone calls **28**  
    text messages **28**

## O

odometer **25, 81**  
oxygen saturation **6, 55, 56**

## P

pace **65**  
pairing **32**  
    ANT+ sensors **41**  
    Bluetooth sensors **112**  
    sensors **105**  
    smartphone **4, 112**  
payments **35–37**  
performance condition **45, 49**  
personal records **69, 70**  
    deleting **70**  
phone calls **28**  
pin location, green view **26**  
points of interest (POI) **74, 79**  
power **16**  
power (force) **45**  
    alerts **87**  
    meters **47, 50, 106, 123**  
    zones **58**  
profiles **11**  
    activity **15**  
    user **56**

projected finish time **47**  
pulse oximeter **6, 40, 55, 56, 60**

## R

race predictor **45**  
racing **69**  
recovery **45, 51, 53**  
resetting the device **103, 113**  
routes **9, 74**  
    creating **9**  
    direct-to **7**  
    settings **88**  
    viewing on the map **10**  
running dynamics **15, 42–44**

## S

safety information **33**  
satellite signals **90, 113**  
saving activities **14, 15, 26, 27**  
scorecard **24, 25**  
scoring **24**  
screen **104**  
segments **67, 68**  
settings **22, 34, 56, 60, 82, 83, 87, 88, 91, 93, 98–104, 113**  
sharing data **105**  
shortcuts **2, 97**  
Sight 'N Go **76**  
skiing **16**  
    alpine **16**  
    backcountry **16**  
    ski touring **16**  
    snowboarding **16**  
sleep mode **59**  
smartphone **31, 32, 35, 92, 112**  
    applications **27, 34**  
    pairing **4, 112**  
snowboarding **16**  
software  
    license **105**  
    updating **4, 30, 31**  
    version **105**  
specifications **108**  
speed **89**  
speed and cadence sensors **106**  
statistics **25, 26**  
stopwatch **72**  
storing data **30, 31**  
stress level **45, 48, 54, 96**  
stress score **48, 54**  
stride length **42, 43**  
strokes **19**  
sunrise and sunset times **104**  
swimming **19, 20, 62, 63**  
swing analysis **25**  
swolf score **19**  
system settings **103**

## T

target **23, 69**  
tempe **107, 113**  
temperature **52, 94, 107, 113**  
text messages **28**  
time **104**  
    alerts **87**  
    settings **103**  
    zones and formats **103**  
time zones **104**  
timer **14, 15, 26, 27, 80**  
    countdown **71, 72**  
tones **17, 71**  
TracBack **12, 77, 78**  
tracking **32, 56**  
tracks **74**  
training **15, 27, 52, 53, 62, 64–67, 69, 71**  
    calendar **64**  
    plans **60, 63, 64**

Training Effect **45, 48**  
training load **51, 52**  
training status **45, 51, 52, 62, 70**  
treadmill **13**  
triathlon training **18**  
troubleshooting **15, 40, 44, 54, 56, 111–115**

## U

UltraTrac **90**  
unit ID **105**  
units of measure **104**  
updates, software **30, 31**  
updating, database **3**  
uploading data **31**  
USB **31**  
user data, deleting **108**  
user profile **47, 56**

## V

vertical oscillation **42–44**  
vertical ratio **42–44**  
VIRB remote **95, 96**  
virtual course **13**  
Virtual Partner **68, 69**  
VO2 max. **45–47, 51, 62, 123**

## W

wallet **36**  
watch faces **35, 94, 97, 98**  
watch mode **91**  
water resistance **109**  
waypoints **9, 79**  
    navigating **7**  
    projecting **73**  
    viewing on the map **8**  
weather **5, 94**  
wheel sizes **124**  
Wi-Fi **35**  
    connecting **34**  
widgets **2, 35, 41, 42, 54, 55, 92, 96**  
workouts **60, 62–64**  
    creating **61**  
    loading **61**

## Z

zones  
    heart rate **57, 58**  
    power **58**  
    time **104**



