



# TopBrewer Compact Installation Guide

Aug 12, 2015 Ver. 1.1



## TopBrewer Compact Installation Manual.. Ver 1..0

Installing a TopBrewer can be a fulfilling experience. It's like any project, that are taking shape and once done, the result is mesmerizing.

Still, with the TopBrewer there is a certain degree of unexpected pleasure, when you serve the first piping hot cup of coffee out of the graceful swan neck. The sensation when the liquid flows and the joy brought to those controlling it from their phone.

If you follow this guide carefully, it will fit beautifully into your space.

We hope you will enjoy your TopBrewer Experience.

**#unboxingmytopbrewer**



## Kind Disclaimer

The TopBrewer is a precision piece of machinery, a fine work of engineering that has been built to last. Due to the nature of it's inner workings that are able to produce a second-to-none drink, installation must be done in line with factory recommendations in this manual.





We also strongly discourage you from using parts, tubing, fittings and items of that nature, that are not supplied by TopBrewer.

We also recommend only using TopBrewer certified consumables, such as Coffee (so that we may help you adjust your machine), Water Filters, Co2 bottles and Cleaning tablets.

Only this way we can ensure that your machine works to the best of it's ability.

# SPACE REQUIREMENTS

## INSTALLATION REQUIREMENTS

	TopBrewer	ICE-bank Fridge
Power	208-240V AC, 10/20 Amp 1 phase, 2,3 / 4,6 kW, 50/60hz	220/110V AC, 4 Amp, 50/60hz
Plug-type	  EU: Local 230V US: 6-20R / 6-20P	  EU: Local 230V US: Local 110V
Water	Direct Water Connection. Water pressure: 200kPa (2 Bar) - 600 kPa (6 Bar)	
Filtration	TopBrewer Pure Filtration kit provides the best water quality and easy installation	
Drainage	1 x Waste U-pipe	
Ventilation	Machine and fridge produces heat, which needs to be able to exit as per installation instructions. See ventilation requirements page 5	

## ACCESSORIES

- High-Gloss Stainless tap
- Brass tap, polished
- Cobber / Patina tap
- iPad in-counter
- Tabletop Drip tray
- Drip tray w/lip
- Active fan kit

## WHAT'S IN THE BOX?

### TopBrewer Machine

- TopBrewer, Faucet, mounting bracket, recessed drip tray with grate, quick start guide, cleaning brush, cleaning tablets

### ICE-bank Fridge

- ICE-bank Fridge, Milk pump system, connections to TopBrewer, MilkSpear, Co2 Double manometer

### Filter Kit

- 2 x TopBrewer Pure 50 filter, 1 x ActiveCoal 10000, tubes, all fittings and connections, one way safety valve, mounting diagram.

## Faucet and drip tray placement

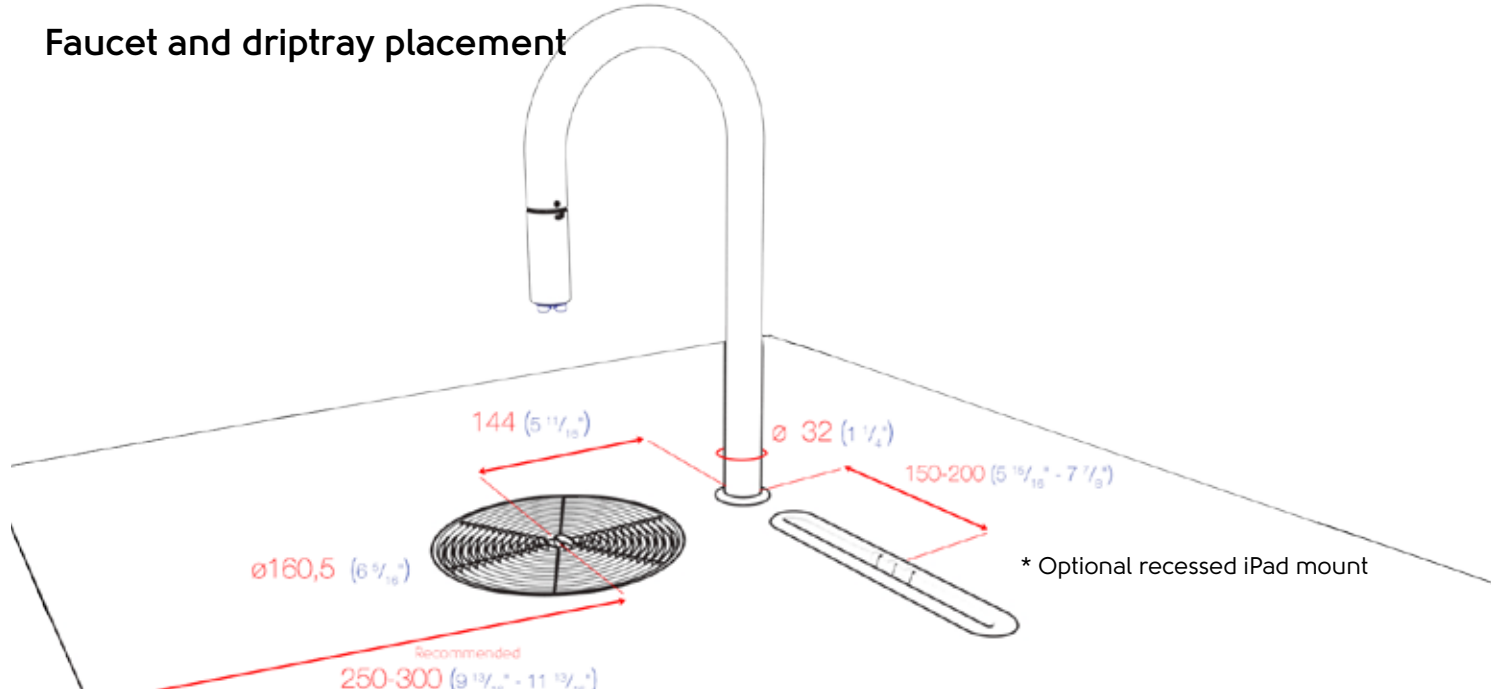

## UNIT DETAILS

\* cm / kg / liter - inches / pounds / gallon

	TopBrewer Machine	ICE-bank Fridge	Filter Kit
Installation Dimensions (WxDxH)	183 x 510 x 670 7 3/16" x 20 1/16" x 26 3/8"	236 x 560 x 430 9 5/16" x 22 1/16" x 16 15/16"	137 x 130 x 267 5 3/8" x 5 1/8" x 10 1/2" (per filter, installed)
Packing Dimensions (WxDxH)	300 x 630 x 780 11 13/16" x 24 13/16" x 30 11/16"	300 x 615 x 490 11 13/16" x 24 3/16" x 19 5/16"	379 x 284 x 165 14 15/16" x 11 3/16" x 6 1/2"
Weight, gross.	41.0 90.4	27 59.5	3.7 8.15
Weight, net.	39.0 85.9	25 55.1	-
Hopper Capacity	1.5 3.3	-	-
Milk carton size capacity (EU/US)	-	2 l. Half Gallon	-
Dreg capacity	60	-	-

\*EU marked items are preferred for installation

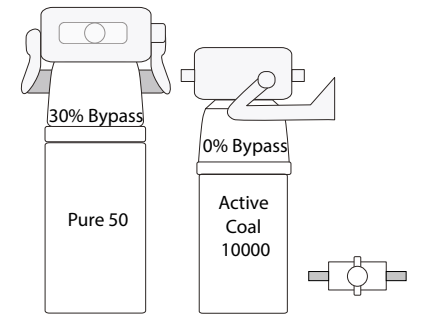
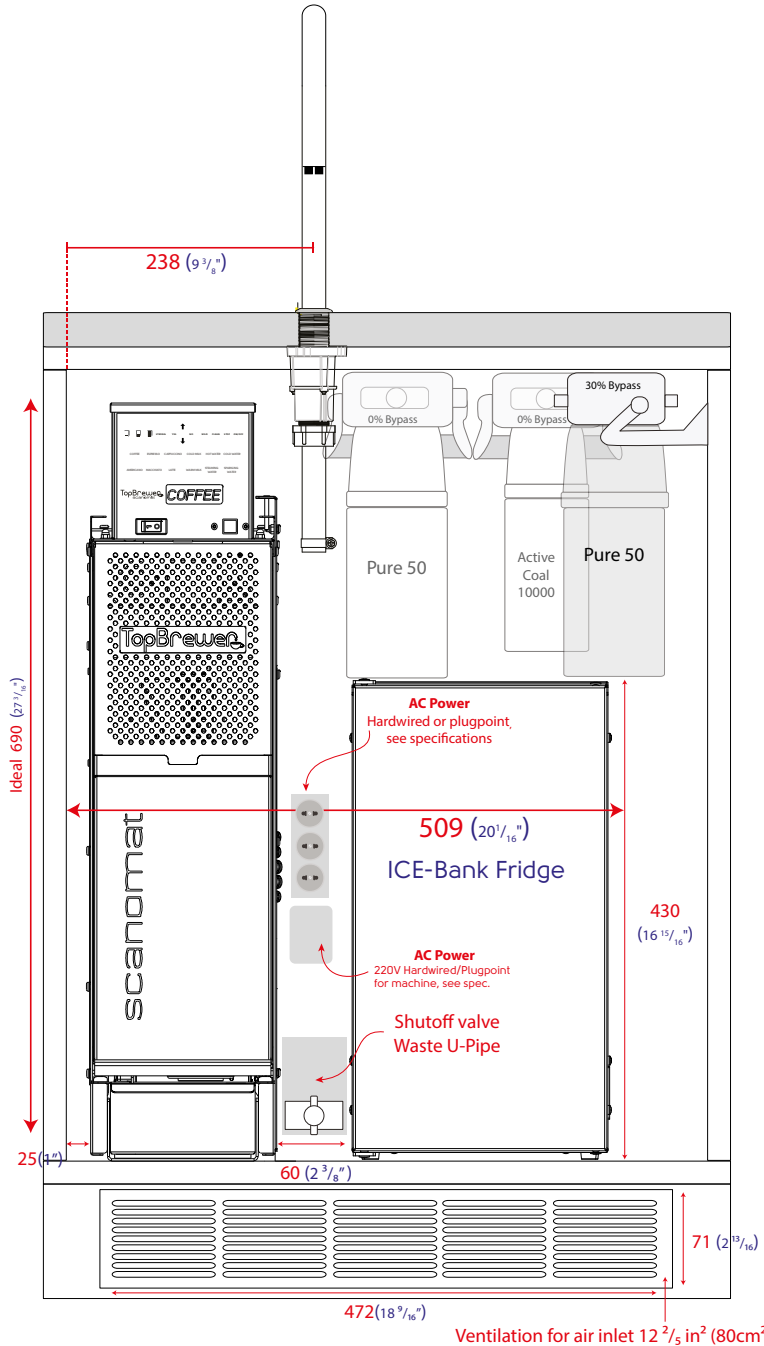
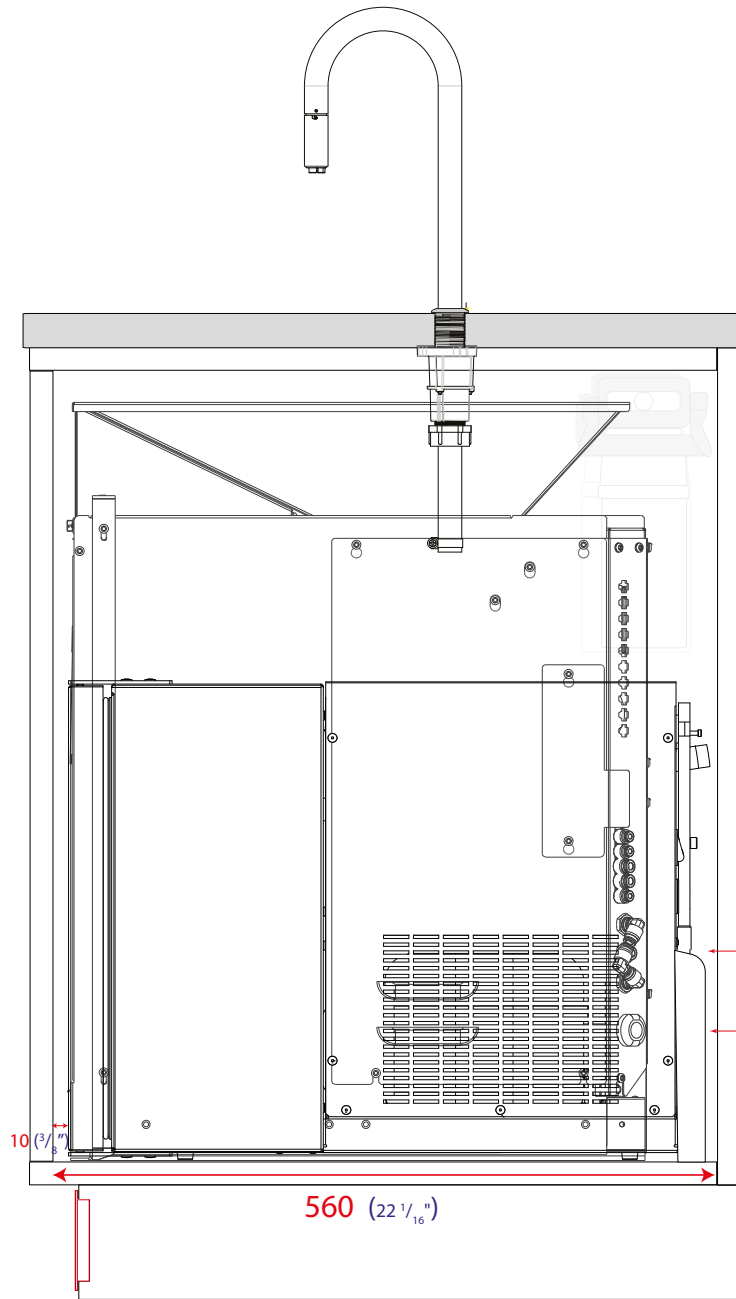

Alternative placement of shutoff valve next to filters  
Filters can be mounted in an adjacent cabinet.

Connection Diagram with ICE-bank Co2 Fridge



- Hose Connections**
1. Flush Water (connected from fridge)
  2. Coffee
  3. Steam
  4. Hot Water
  5. Cold / Carbonated Water
  6. Milk line (connected from faucet)
  7. Steam water out (going to filter)
  8. Main Water inlet
  9. Steam water in (coming from filter)
  10. Water Inlet (for ICE-bank)
  11. Co2 connection hose
  12. ICE-bank fill
  13. Milk Flush Drain Line
- Signal Cables**
- A. Milk Pump
  - B. Cold Water Valve
  - C. Sparkling Water Valve

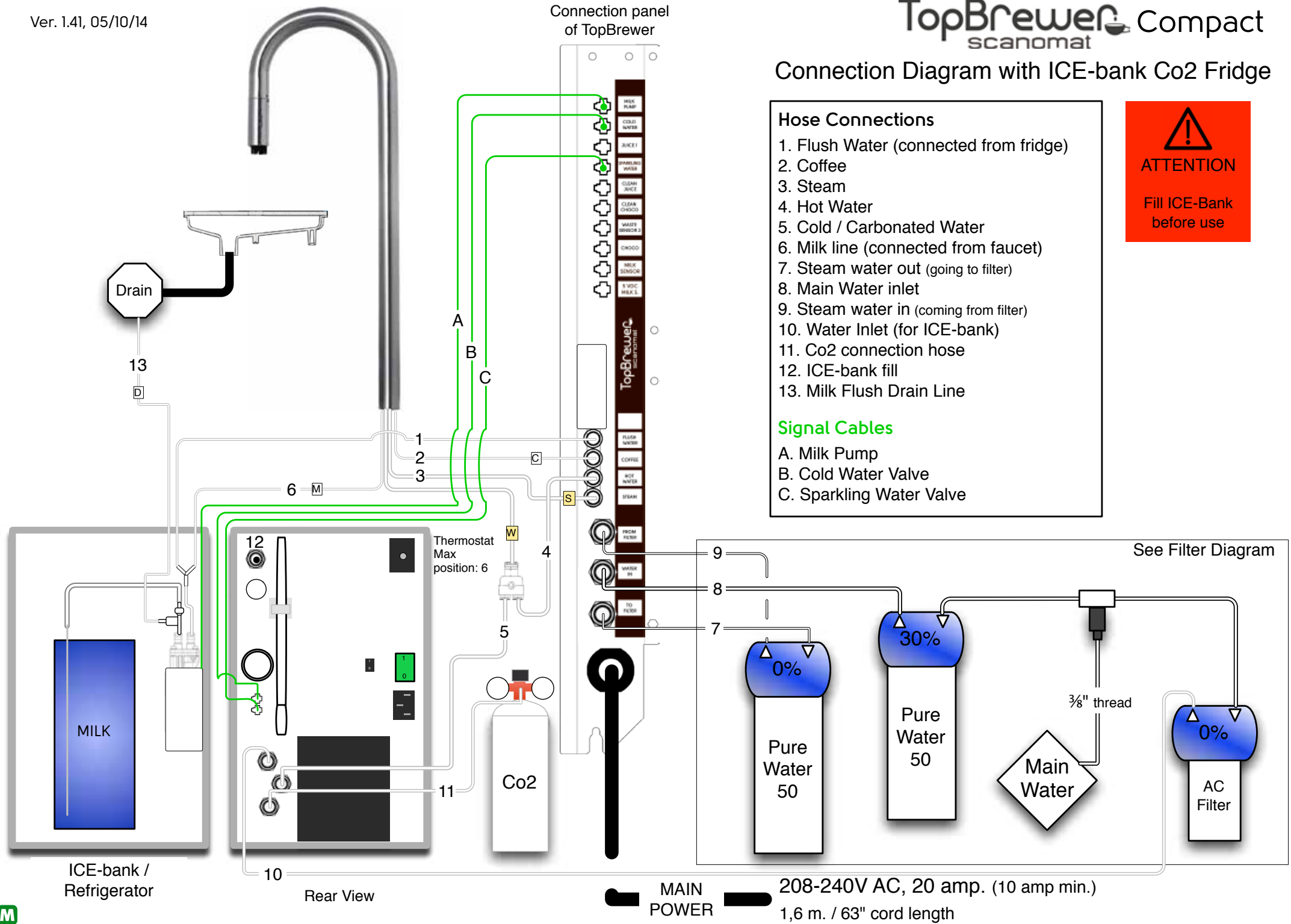

See Filter Diagram

Thermostat Max position: 6

MAIN POWER 208-240V AC, 20 amp. (10 amp min.)  
1,6 m. / 63" cord length



# Filter Starter Kit. Connection Diagram

## Contents of package

- 2 x Pure50 Filters
- 1 x ActiveCoal 10.000 Filter
- 2 x 0% filter heads with brackets
- 1 x 30% filter heads with bracket
- 3 meter 6mm hose
- 2,5 meter 4mm hose
- 1 meter 8 mm hose
- 1 x Y-piece (6x6x6)
- 1 x One-way valve &
- 1 x T-piece (3/8"x8x8)
- 2 x 8x8 Angle Fitting
- 2 x 8x6 Angle Fitting
- 2 x 8x4 Straight Fitting
- 2 x 6x4 Angle Fitting
- 3x 6x6 Angle Fitting
- Lock Clips

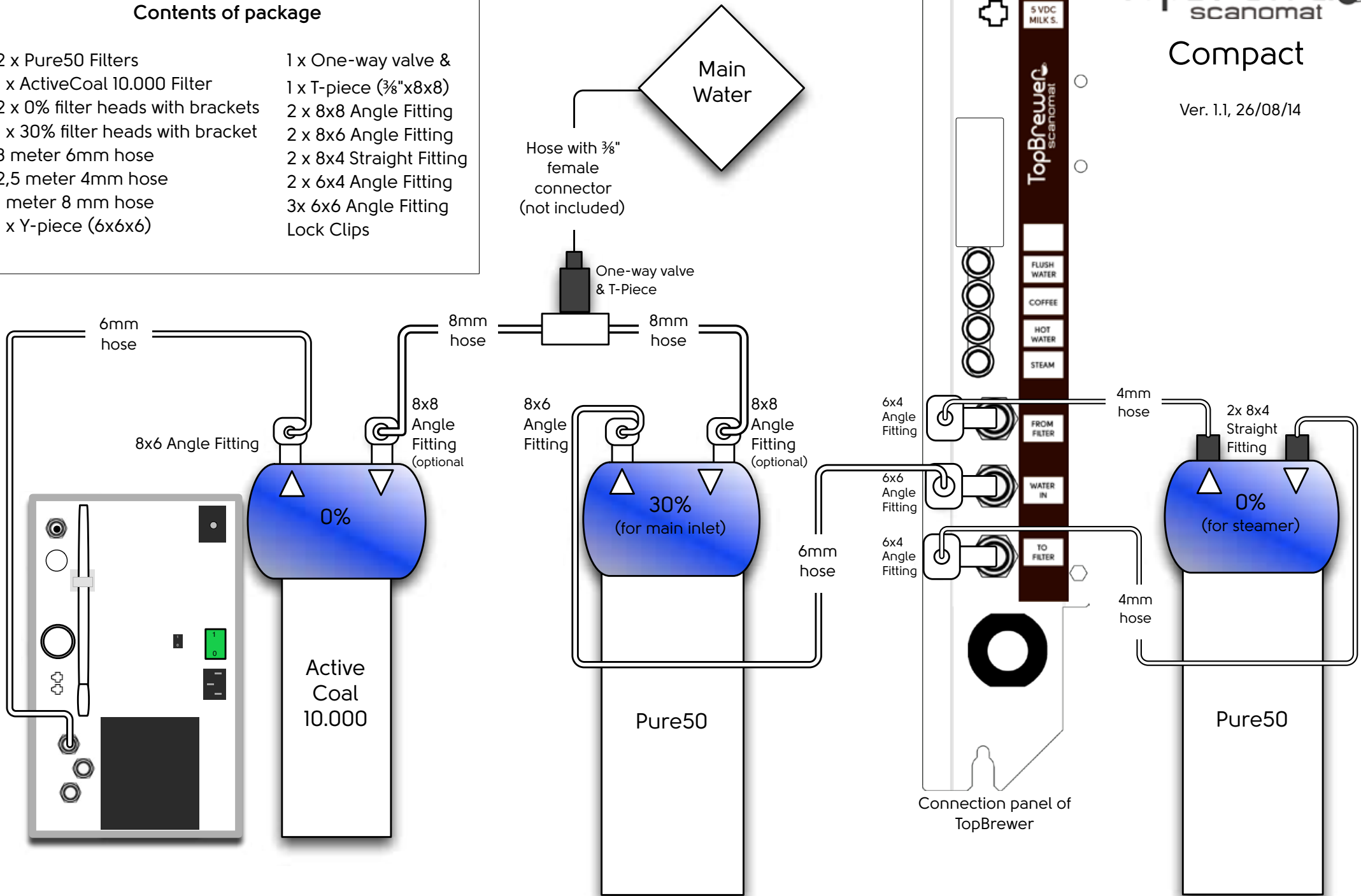

TopBrewer scanomat

Compact

Ver. 1.1, 26/08/14



# The Anatomy of the system

ICE-Bank Fridge

TopBrewer

Filtration Starter Kit



The top of the connection panel, which you will find on the back of the Top-Brewer, is the range of features modules that can be added to the machine currently and in the future. The Top-Brewer system is clever and expandable. This manual concentrates only on the "Milk Pump" coming from the fridge and the sparkling and cold water valves.



A step further down is the quick-fit connections for the hoses. Three of these goes directly into the faucet, with "Flush Water" being the exception, going from the machine into the fridge. (see diagram on page XXXXX)



Lowest on the panel is the Main "Water In" (coming from the 30% bypass filter) as well as two additional connections going to a dedicated steam filter. This to ensure a 100% filtration of the water dedicated to the steamer, preventing scale build.

Also here main AC Power cable.



On the top left side you have an inlet to fill the ICE-Bank with water. This must be done prior to powering it up! The transparent tube reads the fill level. The dial is a pressure regulator for the inlet water, which should only be adjusted if the water is not flowing at a speed, that fills the glass to the level specified in the app.



The two Molex plugs are for Cold and Sparkling water, plugged into the Top-Brewer. These signal cables control the valves inside the fridge individually.

The quick-fit connectors below are for Main "Water In" from the AC Filter, Water out and CO2.



The main power switch (Green) as well as the AC power.

The recirculation switch is to remain on always, controlling the pump that circulates the cooling water that cools the Fridge-space.

# Preparing your space

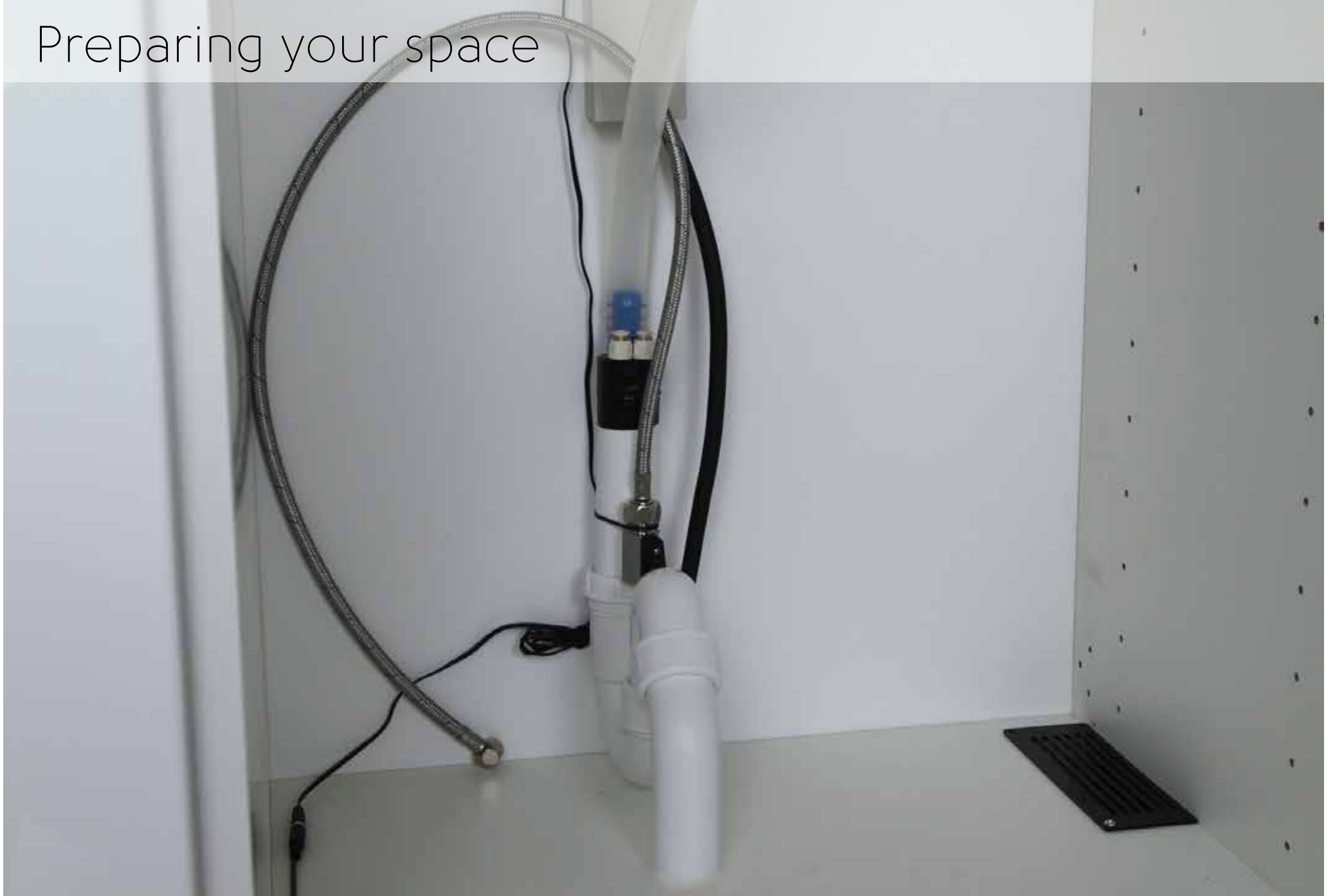

**CARPENTER**

## Readying your tabletop

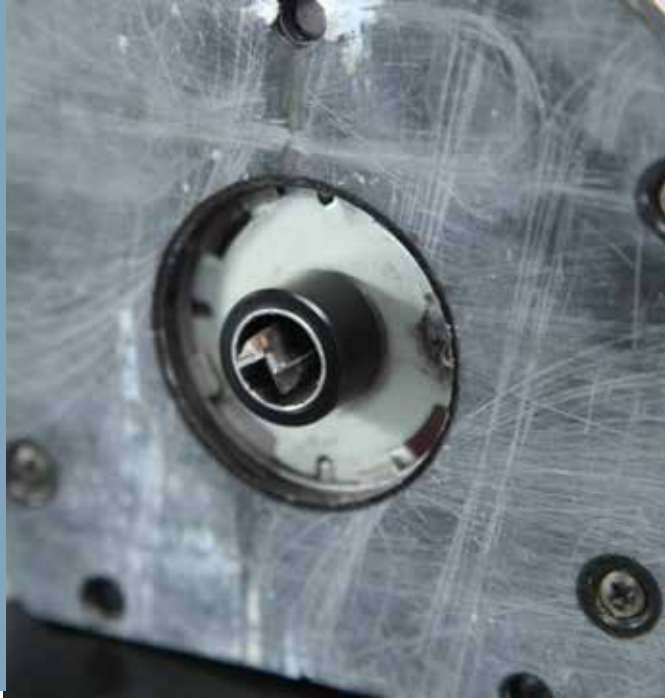

## You will need:

- Cut out template
- Bosch PDF 1200 AE Router or similar
- Clamps



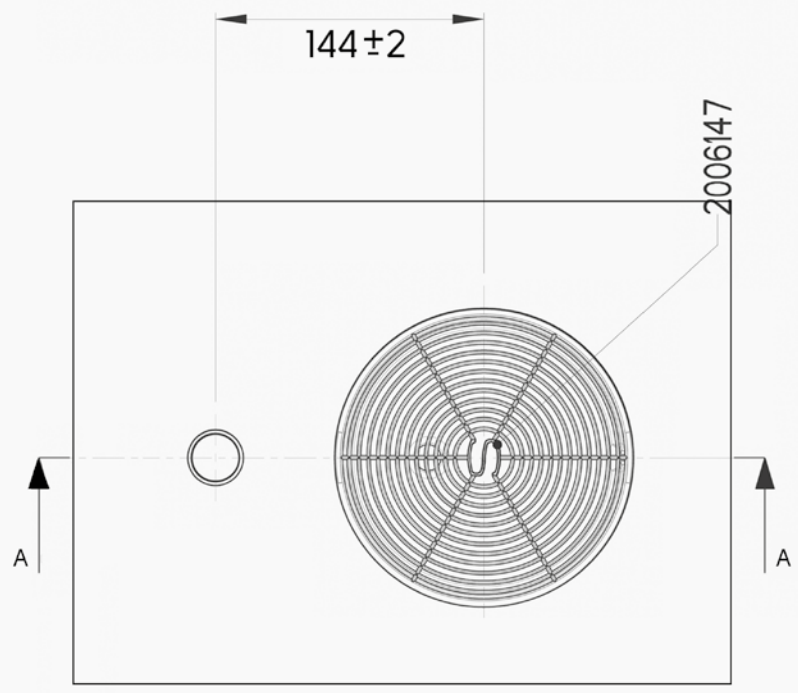
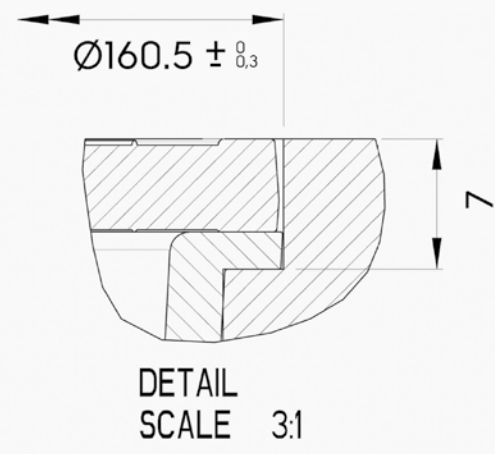
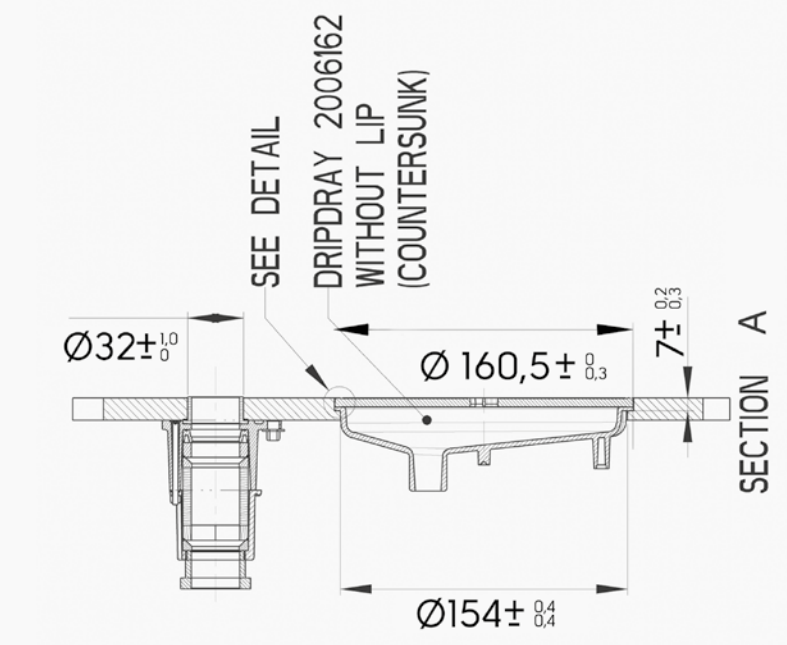

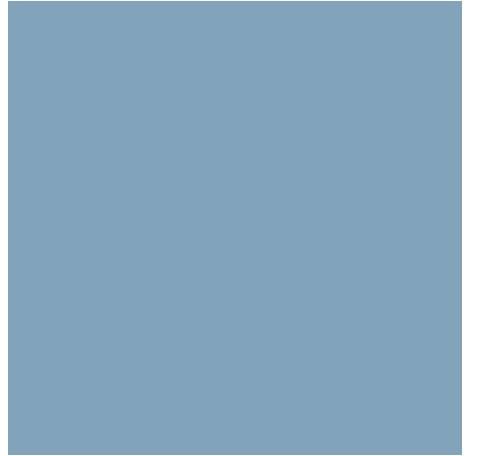

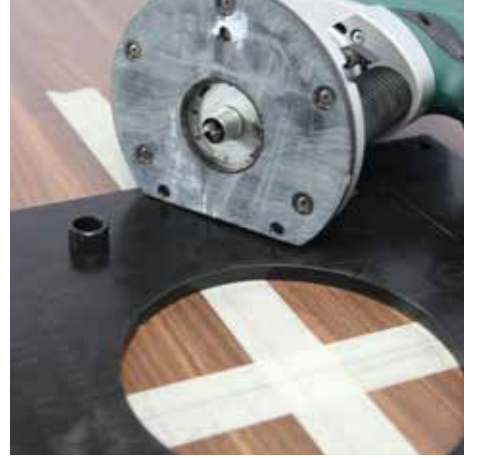



When the hole for the faucet is done, the threaded sleeve is inserted from the bottom, and using the accompanied guide, it's cut to length to allow for enough thread to pass through to reach the bracket that holds the faucet.



Use a silicone adhesive to make a proper seal. It's recommended also to silicone open pours in the wood.



The sleeve is now inserted from the top as shown and the bracket is fitted from below. Make sure to tighten it properly.





Use a silicone adhesive to make a proper seal. It's recommend also to silicone open pours in the wood.



Insert the drip tray so that the drain outlet is aligned with the faucet sleeve.



# SPACE REQUIREMENTS

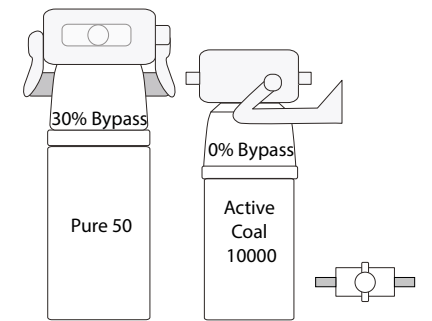
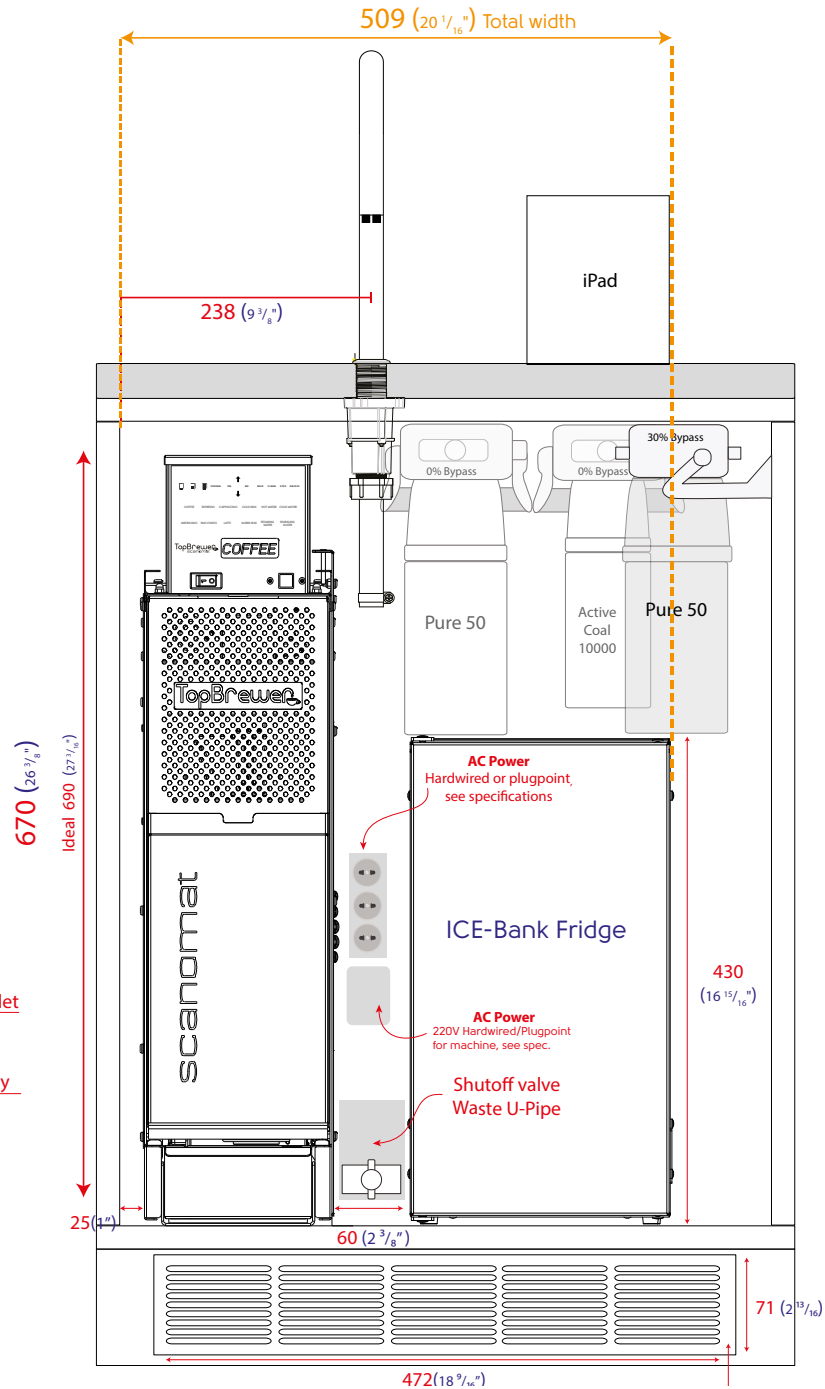
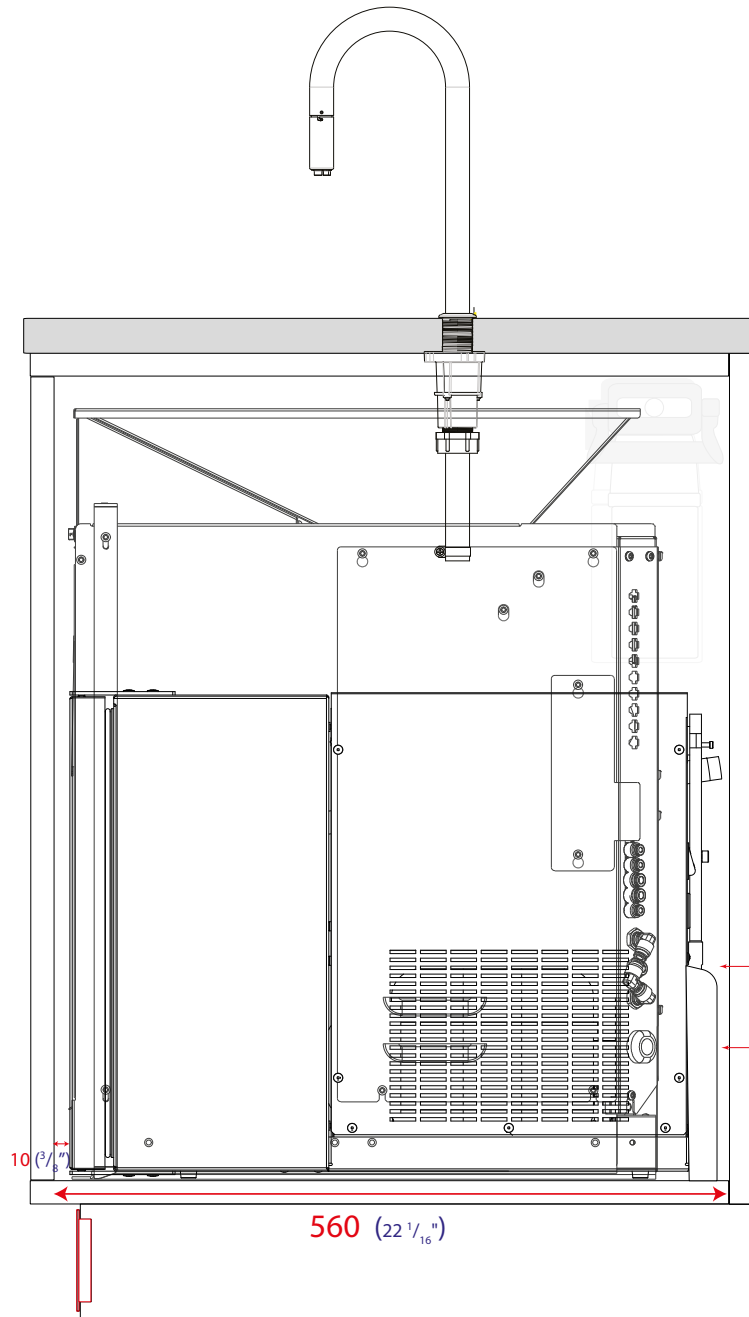

# Cutout overview

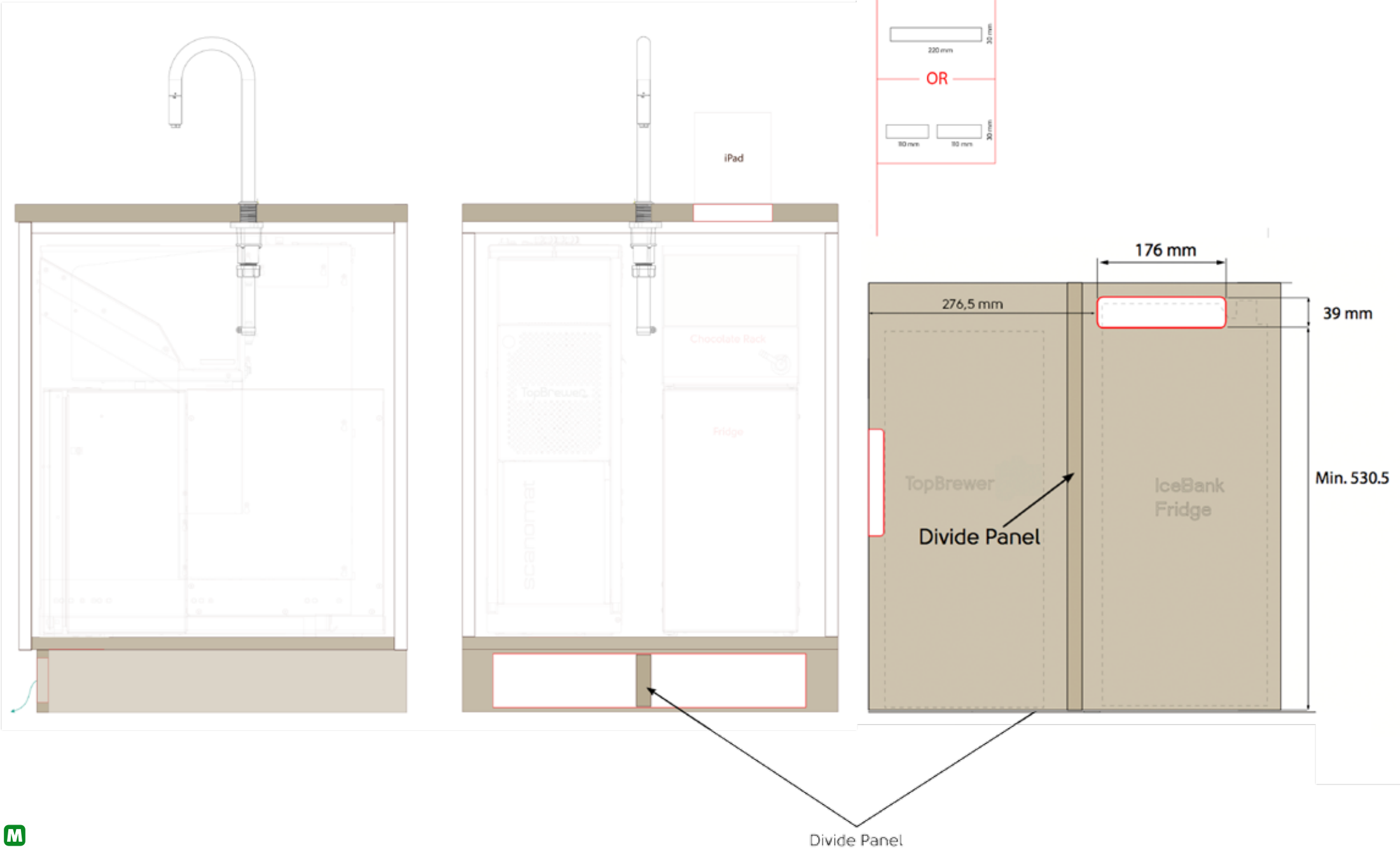



Do cut-outs as outlined in the drawing. It's important to follow exactly, as the base is used as a ventilation chamber to allow fresh air in and hot exhaust air out.

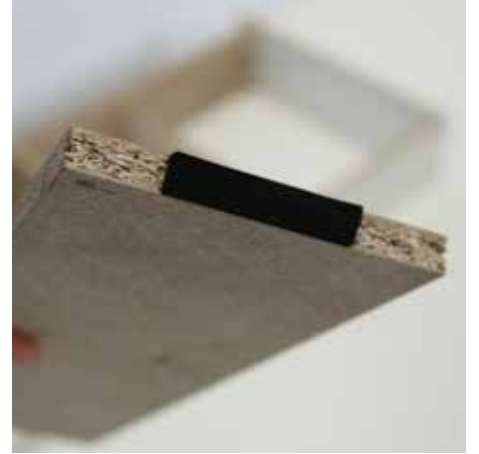



The hole in the far right of the cabinet is for the fridge - so the placement of the fridge is decided by this cut-out.



Use a Fein-cutter or similar



# PLUMBING

# Plumbing option 1

- Drainline from driptray  5 cm
- Fridge waste water
- Drainpump from machine
- Main Water w/ shutoff valve

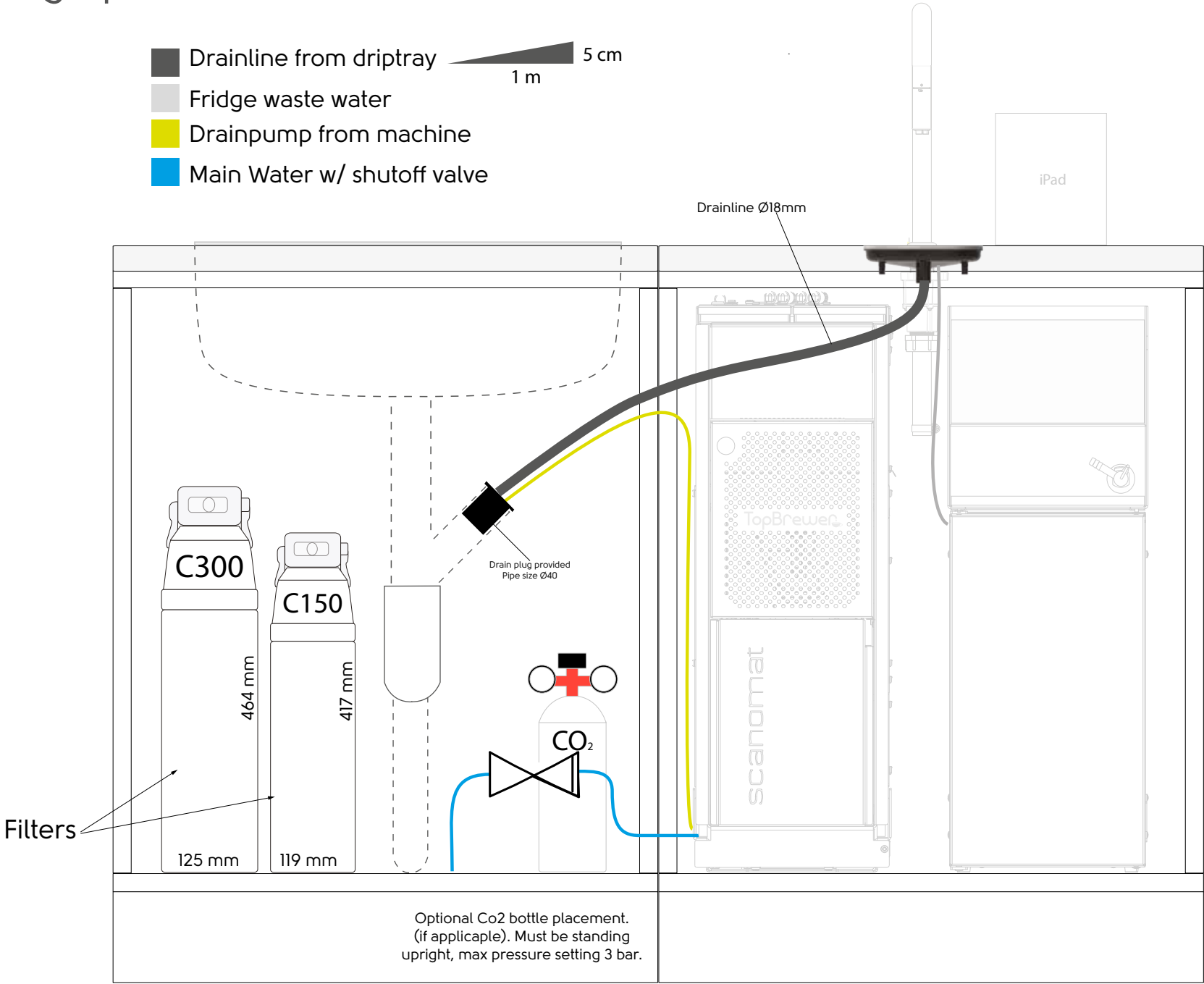

# Plumbing option 2

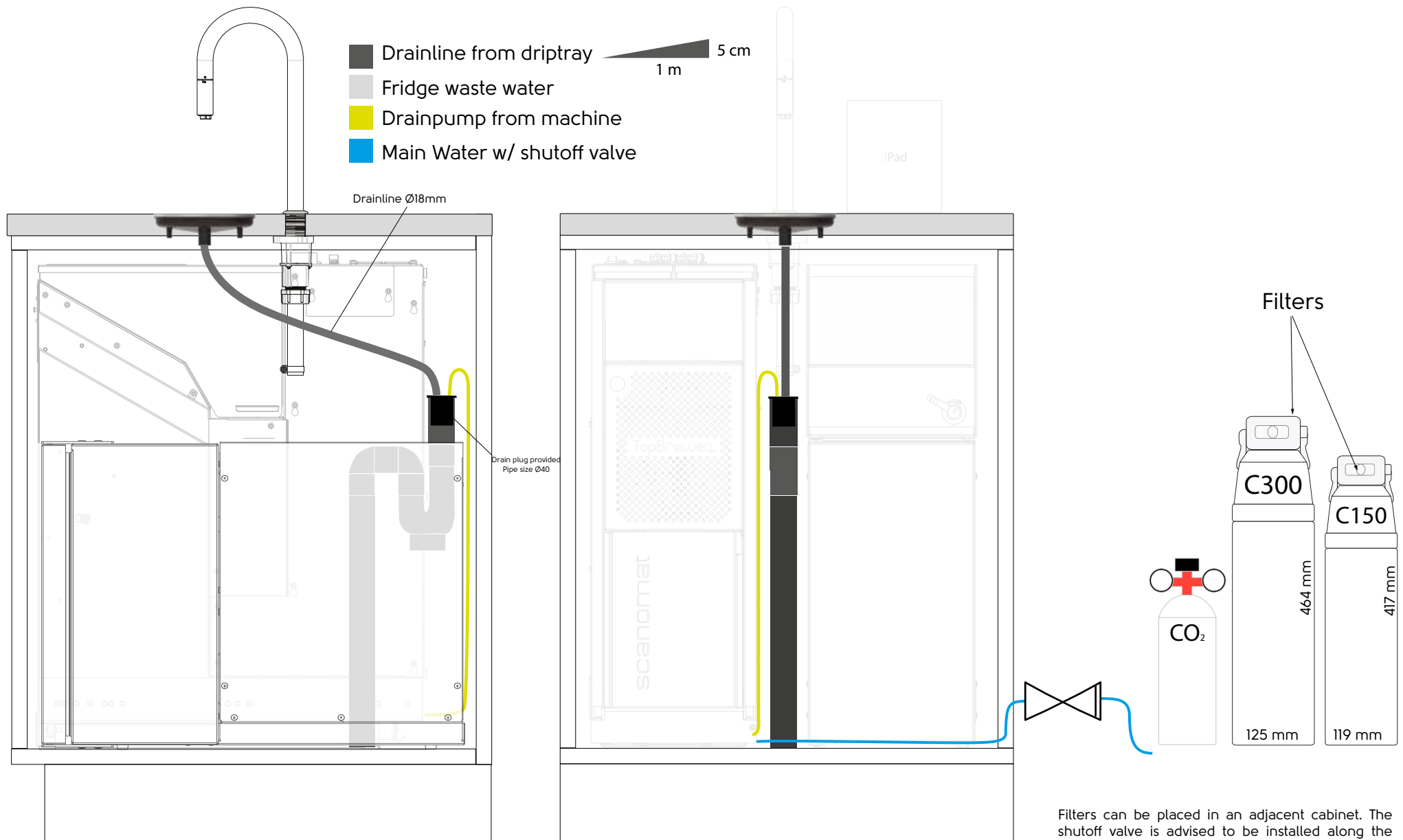

Filters can be placed in an adjacent cabinet. The shutoff valve is advised to be installed along the filters, also obeying local rules and regulations. Co<sub>2</sub> canister (is applicable) must be standing upright.



Drain can be positioned either like shown in the center of the cabinet in between the machine and fridge.

Electrics can also be mounted in the top-right corner of the cabinet, when this space is not reserved for filters.





The machine is delivered with a 3/8 inch male check-valve. Not supplied is a country specific connection hose and shutoff valve.



An overview on how the installation could end up looking like.





## Filtration starter kit

The kit consists of:

- 2 x Pure50 Filters
- 1 x ActiveCoal 10.000 Filter
- 2 x 0% filter heads with brackets
- 1 x 30% filter heads with bracket
- 3 meter 6mm hose
- 2,5 meter 4mm hose
- 1 meter 8 mm hose
- 1 x Y-piece (6x6x6)
- 1 x One-way valve &
- 1 x T-piece ( "x8x8)
- 2 x 8x8 Angle Fitting
- 2 x 8x6 Angle Fitting
- 2 x 8x4 Straight Fitting
- 2 x 6x4 Angle Fitting
- 3x 6x6 Angle Fitting
- Lock Clips

Note: This is a proposed setup. Installing the filters in adjacent cabinets is also an options, as long as supply lines are able to move freely and not obstructing the sliding motion of the machine. Leave also lenth enough for the fridge to be pulled out for service.



First, fit the O-ring as shown in the check valve and insert the white T-piece and tighten.

The first 0% head (see label on top) is fitted with the two straight fittings (4mm) as shown.

The second 0% head is fitted with first a 8mm angle fitting on the "in" side as shown.





And next a 6mm angle fitting on the "out" side.



Cut two pieces of 6mm hose to length, at 6 cm



Fit the T-piece we assembled before on the "in" side of the 30% head. The T-piece is used to supply main water to the machine (through the 30% head) and also water to the fridge, through the 0% head.

Fit the other piece of hose to the other side of the T-piece and secure with lock clips.



Fit the heads onto the filters. Ensure (above) to extract the small vent-hose as shown first.

30% head fits: Pure 50

0% head (with straight fittings) fits: Pure 50 filter

0% head (with angle fittings) fits: ActiveCoal 10.000 filter

As shown to the right here, a proposed configuration puts the 30% filter and the 0% with the angle fittings next to each other.





Connect the two filters like shown using the T-piece, so create a "corner".

Next, place the brackets accordingly inside the cabinet.



The last filter (with the straight fittings) shall always be placed fairly close to the machine, allowing the two 4mm hoses to move freely, when pulling the machine in and out.

## Installing the TopBrewer

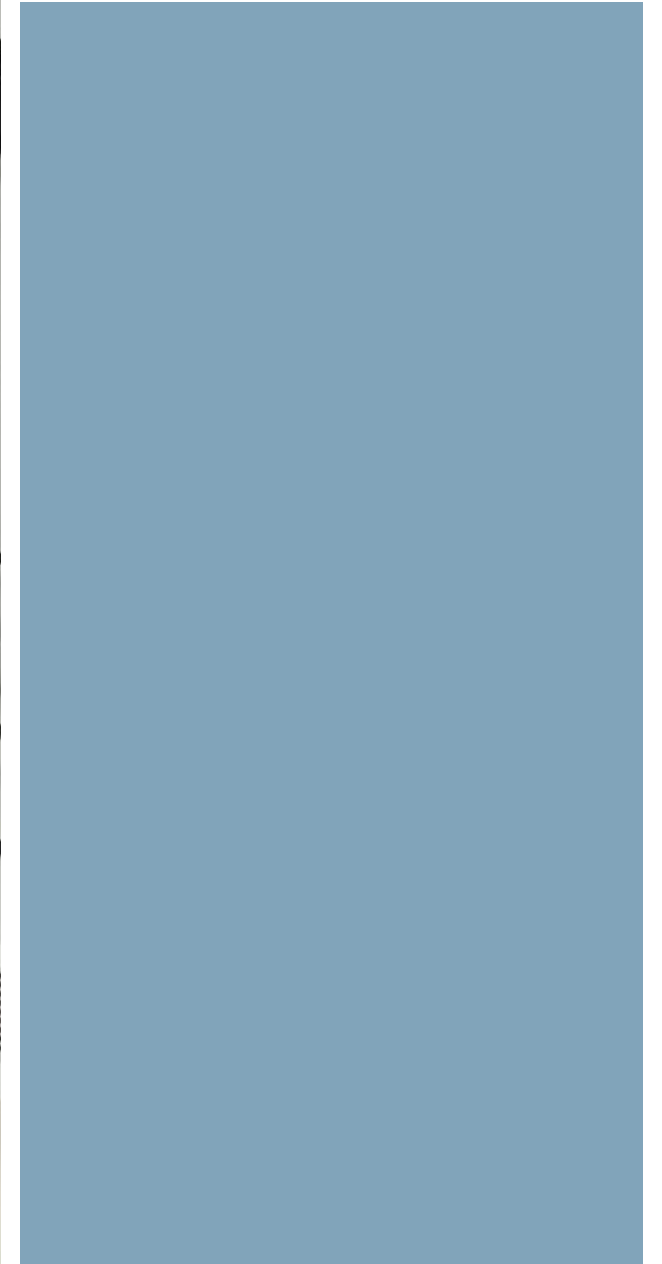

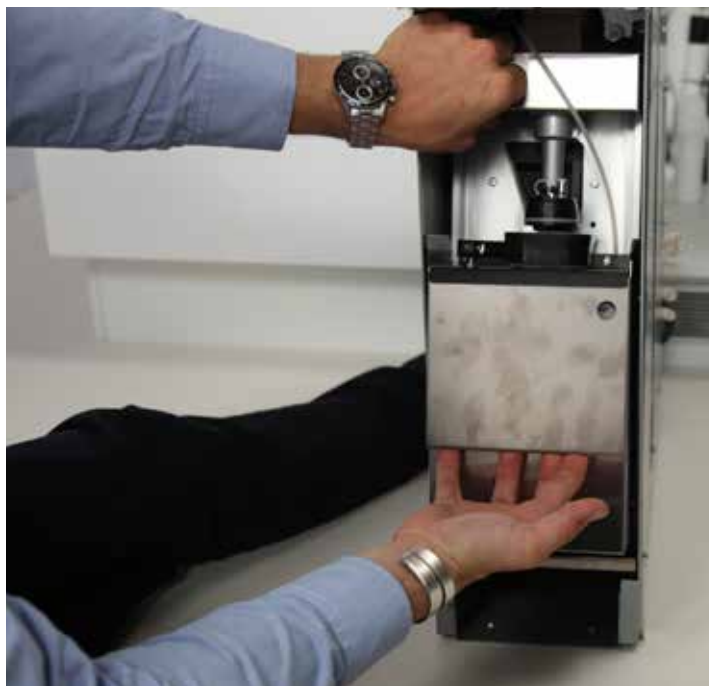

Remove excess wait like the dreg bin, waste tray and brewer to easy handling.



Remove also the bean canister.

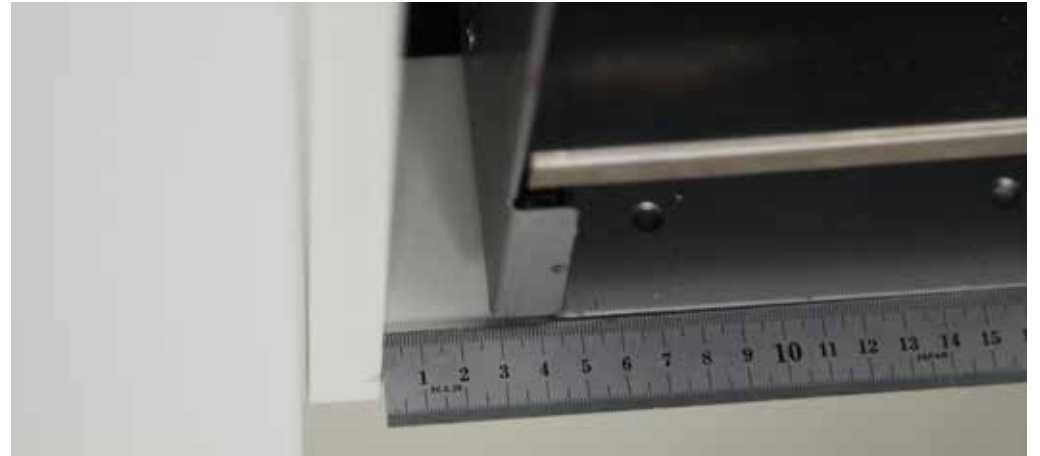

Allow for minimum 30 mm of clearance on the left side of the machine and 10 mm on the front





To ease installation, use a support while securing the machine to the cabinet floor as shown.

Secure the machine with minimum 6 countersunk screws as shown.

Mount the lock-hinge, preventing the machine from sliding out, in the bottom of the cabinet.





Connect electricity to the main. Ensure enough length, and use the machine at full extension to measure the correct distance.



Connect the "From Filter" and "To Filter" 4mm lines to the filter we've prepared with 0% bypass, to the female connectors. Ensure once again the machine can be pulled out and cable-tie alongside the power line.



You will need:  
A tube-cutter  
Cable ties





Connect next the main water inlet to the 30% bypass filter on the "out" side, using the 6mm line provided and shorten accordingly. Cabletie alongside the hoses as well.



Installing the Fridge



Start by filling the fridge with water, using the supply line from the Active-Coal 10.000 filter. Using the shut-off valve, we can now fill the ICE-bank to the fill level illustrated on the back of the machine.

Once finished, ensure to refit the plug.



During the installation process, place the fridge 20 cm from the front of the cabinet. We're going to use this distance as our guide in making hoses and connections the right length.

Connect first the drain line (marked D) to the drain. This is for the flush water exiting the fridge. Next, connect the flush water hose, also coming out the back of the fridge, to the "Flush Water" outlet on the back of the machine as shown. You can use an angle if this eases install.





Odip eum am veriusc ipisci tat lut do voloreratem zzriustrud et nonsequat, veriusto odolorerit dolum alit vol borem quat wissi. Ex ent ea faci ercipit iriure.

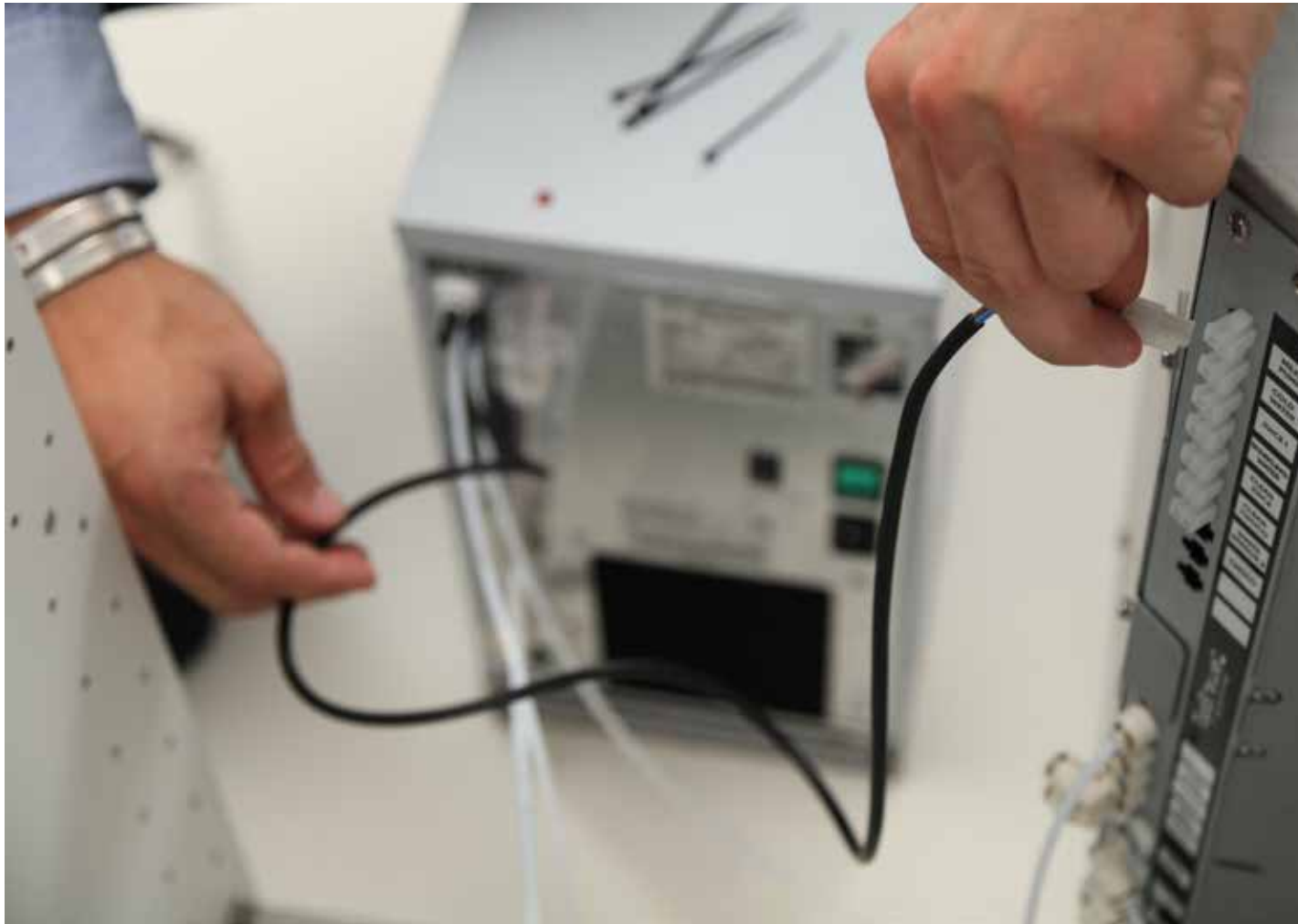

Installing the Fridge



Connect both signal cables. One is for sparkling water and one is for cold water. Ensure to match up each end with the correct plug from the back of the fridge to the back of the TopBrewer.



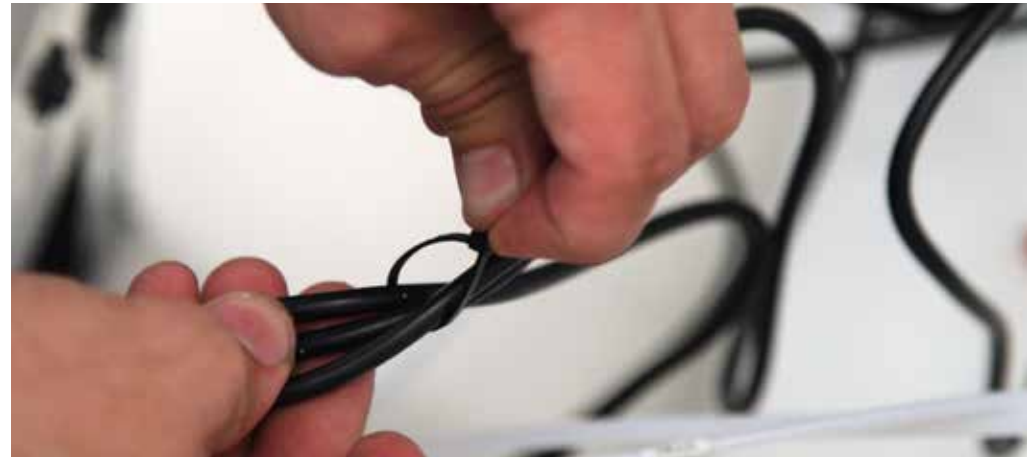

Shorten as much as allowed, bundle the wires together with a cable-tie as shown .

Next, fit the electricity cable to the back of the fridge.

Please turn on the fridge, as it will take approx 3-4 hours for it to form ice and subsequently start cooling. Engage recirculation switch.

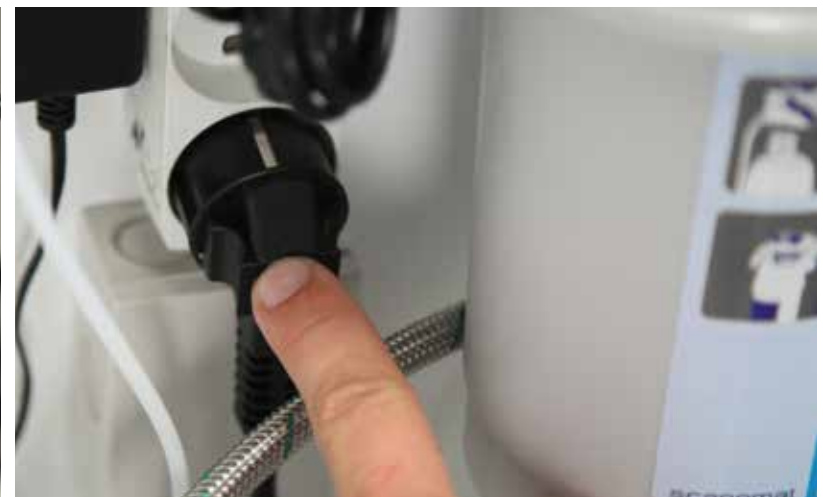



When correctly installed, here shown from the top, filters are placed neatly inside the cabinet and all hoses and cables are neatly tied together, creating a well arranged installation area.



Installing the faucet requires some preparation steps.

1. Remove the labels, noting with a marker where they fit
2. Remove the clamp
3. 30 mm from the base, cut off the insulating hose and save for later



1



2



3





1: Shorten the "hot water" or "W" hose to 40mm in length.

2. Insert the sleeve that helps the faucet glide easier through like shown



3. insert the faucet and secure the clamp back in place, acting as a stop.



Lower the faucet down to its bottom position

Fit the Y-piece onto the "Water" or "W" line that we shortened earlier.

Fit a 6mm hose to one of the inlet of the Y-piece and use the machine, that is still pulled out fully, as a guide to making it the right length.

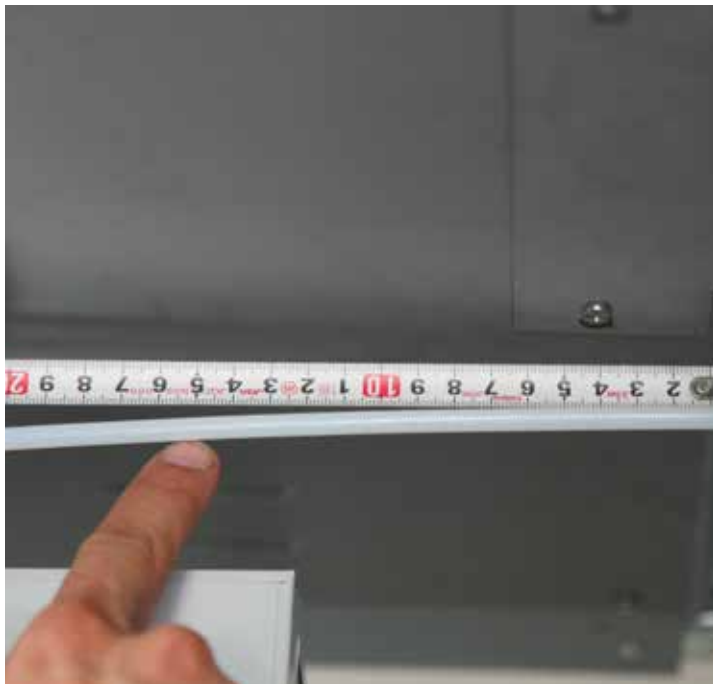

Measure from the back edge of the machine and 15cm and use this as your guide to cut the hose.

Use the Water line, that we just cut, as a guide to shorten the remaining lines coming out of the faucet.

**IMPORTANT!** Do not cut the 4mm hose, labeled with a "M" for milk. Leave this aside for now!



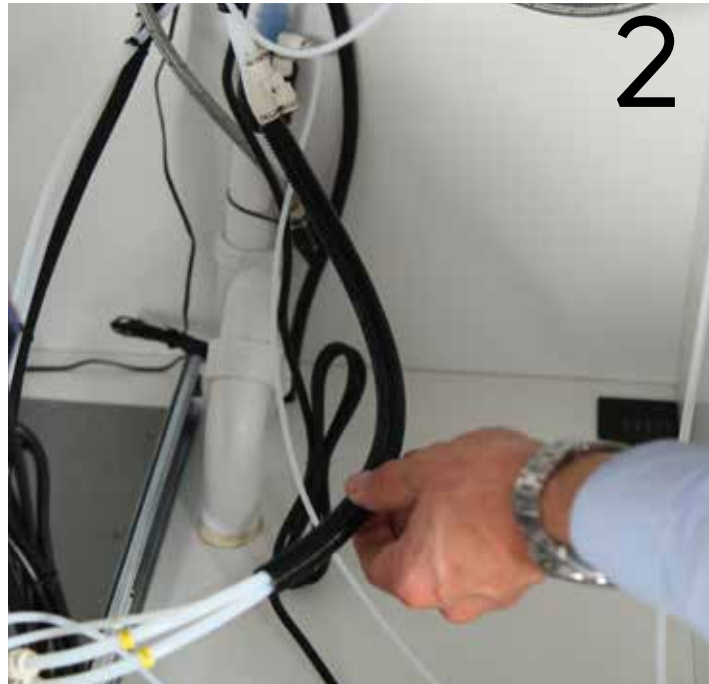
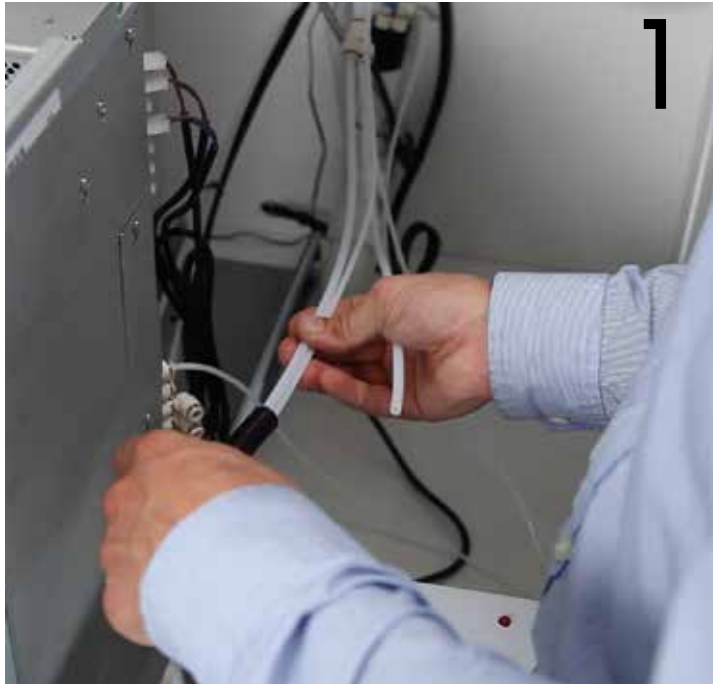

1. Mount the isolation hose. (excluding milk line)

2. Fit back labels to their original place.

3. Connect the lines to the right outlets on the back of the machine. (see diagram as well)  
Use angles to ease the tension on the lines.vv

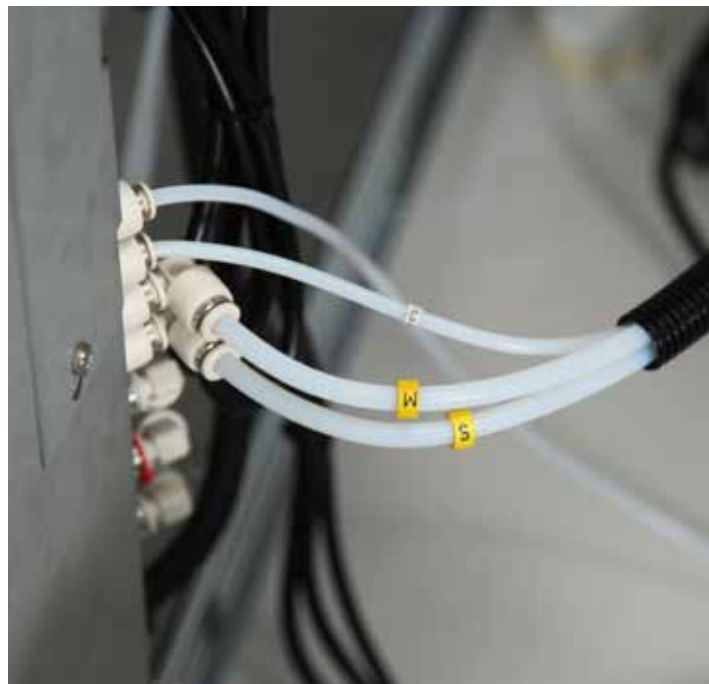
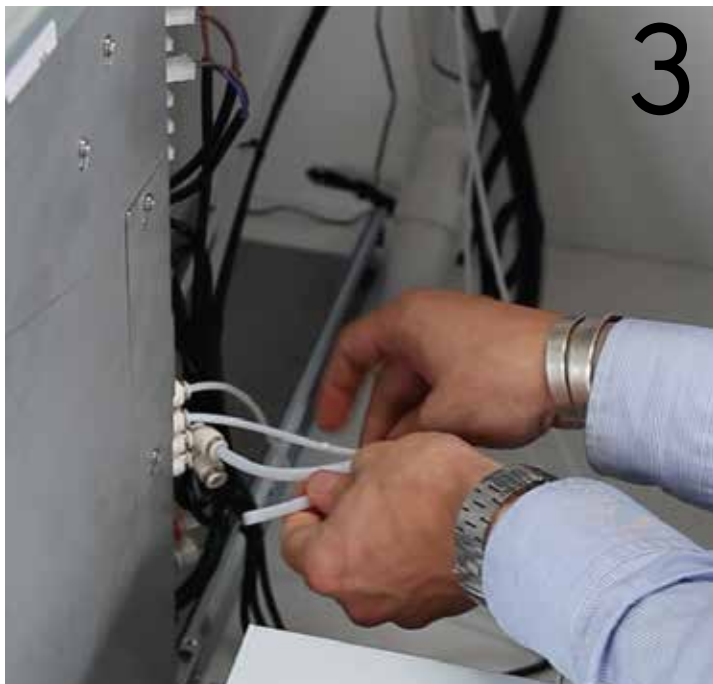



The other leg on the Y-piece is connected to the cold-water outlet on the fridge. Cut a small length of 6mm hose and fit to a double-female connector as shown. Using the 4mm line, which is exactly 1 meter long, connect the hose to the double-female connector on one end, and the fridge water-out on the other end as shown





1. Next, locate the milk line that we put aside before.
2. Pertrude the milk line, coming frm the faucet, and into the back of the fridge as shown above.
3. Poke the line through the rubber seal and pull through as far as it extends
4. Cut of at an index fingers length.
5. Ensure a proper fit with the rubber seal as show, pushing into the cylinder



6



7

6. Connect the Y-piece, already prepared inside the fridge, to the Milk Line and the Flush Water line and secure with cable-ties as shown.

7. Connect the drain out on the yellow double-valve to the drain line as shown. A finished installation sits neatly onto the rubber seal, with the seal pushed all the way flush with the cylinder to allow no air to pass.

Note: Along the process, ensure to fit labels back to the lines accordingly.



Next, fit back the brewer. Remember to connect the coffee-hose to the top piston.

Tighten the finger screw, but omit using tools.

Replace both dreg and waste bin as shown.





Fit the Co2 bottle (if applicable), using a 6mm hose going from the back of the fridge and to the manometer.

Fit the manometer and secure to the bottle. Do not overtighten.

Slowly, engage the pressure by rotating the top bevel clockwise.

**Pressure setting: 3 bar**

The Co2 bottle can by all means, be placed in an adjacent cabinet.



Use the milk sphere to poke through a milk carton like shown, once the milk fridge is producing cooling.

# Adjusting the Grinder



The grinder is delivered at a factory preset setting and can be adjusted for optimum extraction.

We recommend doing this when the machine is getting installed, using TopBrewer Coffee.

1. Pull 1 or 2 espresso shots, standard of the menu. Measure the time of the extraction, from the second you push the button to the second it stops pouring coffee. This time should be around 30 seconds.

2. To adjust the pour, go to the menu (arrow up) and located Adjust > Grinder. Select "Grinder 1". A greater number here is finer = longer extraction. A lesser number is coarser = shorter extraction.

3. Make an adjustment and hit "Yes" so save. Exit the menu by hitting "No" or wait a few seconds and the machine will time out.

4. Pull 2 espressos and measure the second.

5. Repeat accordingly until you get the result you are looking for.



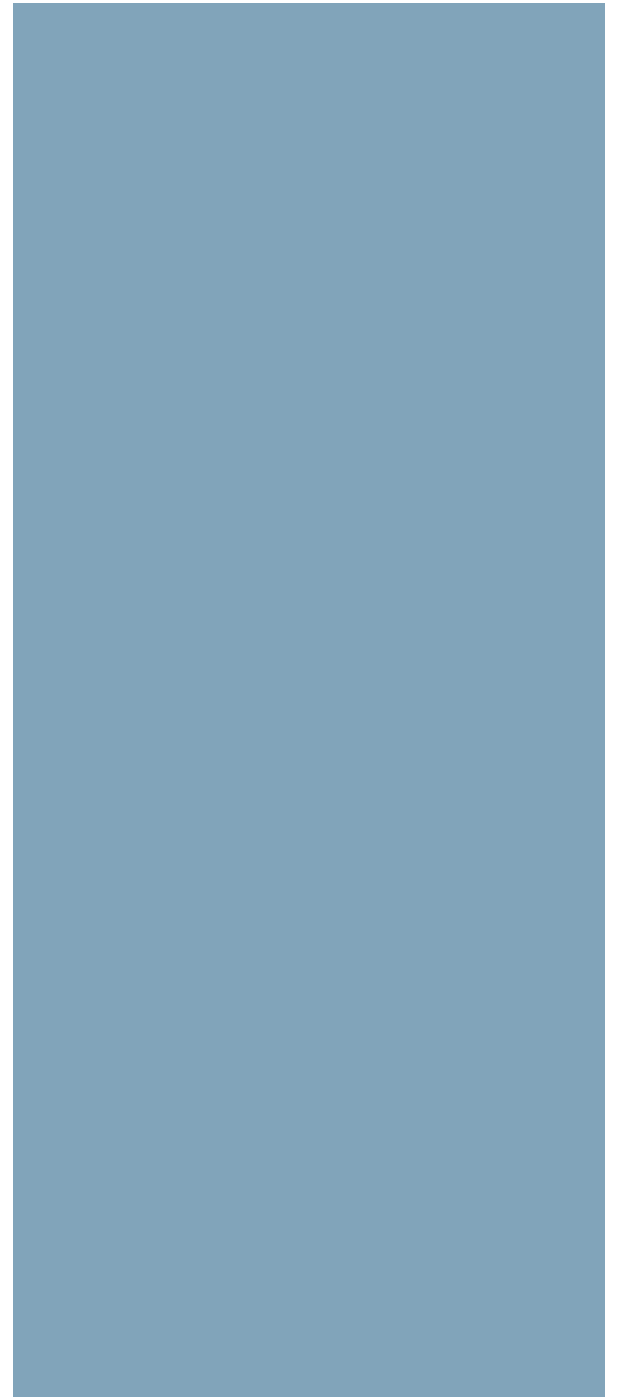





Faucets

