

Commissioning

⚠ Damage resulting from incorrect installation and connection. Installing and connecting the washing machine incorrectly will cause serious damage. Please follow the instructions in "Installation" in the operating instructions.

⚠ Damage resulting from failure to remove the transit bars. Failure to remove the transit bars can result in damage to the washing machine and to adjacent cabinetry or appliances. Please follow the instructions in "Installation" in the operating instructions.

Requirements for networking

Note the following requirements for networking:

1. A Wi-Fi network is available at the installation site. Have the Wi-Fi password ready.
2. The Miele App is available on a mobile device.
3. You have a user account in the Miele App.

You can also carry out networking at a later date. Skip the "Networking" menu option during commissioning.

Carrying out commissioning

■ Approach the washing machine or press **On/Off**.

The display shows the first step for commissioning.

■ Follow the steps in the display. Commissioning is not complete until the commissioning programme has been completed. If the process is cancelled beforehand, the entire commissioning process must be repeated.

Familiarising yourself with the appliance

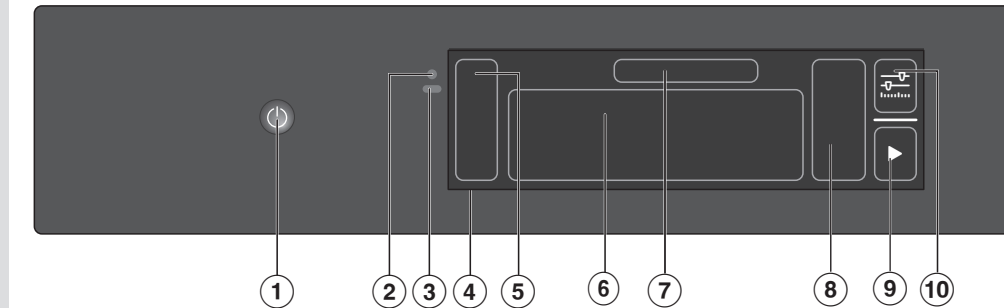

- 1 On/Off sensor
- 2 Optical interface (for Customer Service)
- 3 Proximity sensor (MotionReact)

- 4 Display
- 5 Sidebar
- 6 Programmes
- 7 Name of the highlighted programme

The display can be scratched by pointed or sharp objects, e.g. pens. Only touch the display with your fingertips.

- 8 Parameters for the programme
- 9 Start
- 10 Further parameters

Operating principles

Switching the washing machine on or off
Press **On/Off** until the washing machine switches on or off.

Useful tip: With MotionReact, the washing machine is automatically switched on when you approach it.

Operating the display

Swipe your finger in the required direction in the display.

To select a menu option, press the required menu option or icon. The menu option is highlighted.

Exiting a menu level

Depending on the menu, select **Close window** or **Back**. The higher-level menu is displayed.

Selecting a programme

Automatic safety lock

The washing machine has an automatic safety lock. The washing machine can only be started within 60 seconds of the last operational step on the control panel.

If the 60 seconds are exceeded, the **Start** sensor goes dark. The following question appears in the display: *Release safety lock?*. Confirm the question with **OK**.

You then have another 60 seconds in which to start the wash programme.

Swipe your finger across the display until the required programme is highlighted. If you want to start the programme with the parameters displayed, select **Start**.

Useful tip: If you want to change the parameters, select the programme symbol or **Further parameters**.

Adjusting parameters

Switching parameters on or off

Select the parameter you want to switch on or off. Confirm with **OK**. The parameter is saved.

Changing parameters on a scale

Select the parameter you want to change. Move the scale to the left or right until the required value is highlighted. Confirm with **OK** or wait for the change to be applied automatically. The value is saved.

Displaying the context menu

To open the context menu, press and hold a Favourite or select **Context menu**. Make the required change.

To close the context menu, select **Close window**.

Operating sequence

On the washing machine

1. Prepare the laundry
2. Switch on the washing machine
3. Load the laundry
4. Close the door
5. If detergent is to be added via the dispenser drawer, add the detergent
6. Select a programme
7. Set the programme parameters
8. Start with **Start**

The washing machine door is locked

9. End of the programme

Via the App

1. Prepare the laundry
2. Switch on the washing machine
3. Load the laundry
4. Close the door
5. Select **Remote control** on the washing machine
6. Start the washing machine with **Start**

The washing machine door is locked

7. If detergent is to be added via the dispenser drawer, add the detergent
8. Select a programme via the App
9. Start the programme via the App
10. End of the programme

Tips on operational steps

Preparing the laundry

■ Empty pockets and fasten zips and buttons. Sort laundry by colour and fabric type.

Loading the laundry

■ Unfold the laundry and load loosely in the drum.

Useful tip: Mixing both large and small items gives better wash results and helps distribute the load evenly during spinning.

What to do after removing laundry

■ Check the door sealing ring for any foreign objects.

Useful tip: Leave the dispenser drawer slightly open to allow it to dry. For safety reasons, close the door when the machine is not in use. Otherwise there is a danger of objects being placed inadvertently in the drum. If these remain unnoticed and were washed in the next load, they could damage the laundry. An open door is also a danger to pets and children.

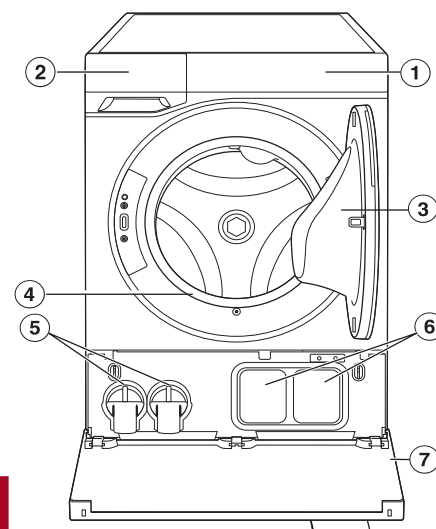

- 1 Control panel
- 2 Dispenser drawer
- 3 Door
- 4 Sealing ring
- 5 Drain filters
- 6 TwinDos
- 7 Plinth flap

More operating options

Delay start

You can use the Delay start to either delay the start of the wash programme or the end of a wash programme. The Delay start function is possible within a 24-hour period. Further information can be found in the operating instructions.

Add laundry (AddLoad)

Laundry can be added or removed if the display shows "Add laundry".

■ Touch the display.

■ Select **Add laundry**.

The wash programme is interrupted and the door will open a little.

■ Open the door fully. Add or remove laundry.

■ Close the door.

■ Follow the process for starting a programme again. The programme will continue.

The programme will continue.

Programme modifications after starting the programme

Once the programme has started, neither the programme nor the parameters can be changed. To make a change, you must cancel the programme.

Once the programme has started, neither the programme nor the parameters can be changed. To make a change, you must cancel the programme.

Cancelling a programme

■ Select **Stop**.

The display will ask whether you want to cancel the programme.

■ Select **Yes**.

The programme is cancelled and the door is opened.

Interrupting a programme

■ Switch off the washing machine.

■ Switch the washing machine on again to continue the programme.

Favourites

You can save up to 12 programmes as Favourites. You can change the programme name and certain parameters for your Favourite programmes. Further information can be found in the operating instructions.

Detergent dispensing options

There are 3 ways of dispensing the detergent.

1. TwinDos
2. Dispenser drawer
3. CapDosing

Using TwinDos

TwinDos must be set up.

TwinDos is automatically activated for all programmes in which dispensing is possible.

The UltraPhase 1 and 2 TwinDos cartridges have a barcode that is read by the washing machine. Therefore, you do not need to enter any dispensing quantities when using UltraPhase 1 and 2. You must specify the dispensing quantities in the following cases:

- The barcode is defective.
- You are using a detergent from another manufacturer.

Replacing the TwinDos cartridge

Preparing the TwinDos cartridge

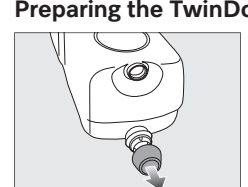

■ Remove the cover cap from the TwinDos cartridge.

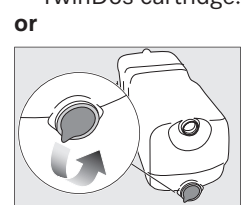

■ Remove the film seal from the cartridge completely.

Replacing the TwinDos cartridge

■ Switch on the washing machine.

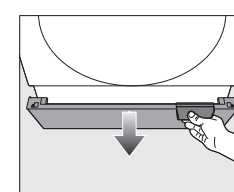

■ Open the plinth flap.

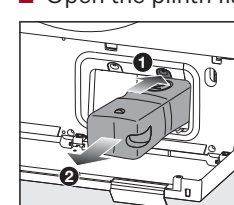

■ Press the lock to release it.

■ Pull out the empty TwinDos cartridge.

■ Insert a new TwinDos cartridge.

Using the dispenser drawer

Ensure that TwinDos dispensing is deactivated.

■ Pull out the dispenser drawer.

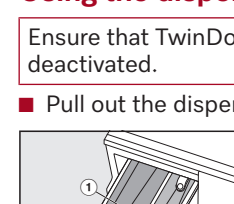

1 **U compartment**

Detergent for the main wash and soaking

2 **U compartment**

Detergent for the pre-wash

3 **U compartment**

Fabric softener, form conditioner or capsules

Adding fabric softener

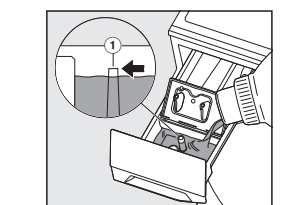

■ Add fabric softener, form conditioner or liquid starch to the **U** compartment. Do not exceed the maximum level mark.

The agent will be automatically dispensed in the final rinse cycle. At the end of the programme, a small amount of water remains in the **U** compartment.

Using detergent tablets or pods

■ Always put detergent tablets or pods directly in the drum with the laundry.

■ Close the dispenser drawer.

The programme will dispense the contents of the capsule at the correct time.

When using CapDosing, water intake to the **U** compartment takes place solely via the capsule. Do not add any additional fabric softener to the **U** compartment.

■ Close the lid and press it firmly shut.

■ Close the dispenser drawer.

The programme will dispense the contents of the capsule at the correct time.

When using CapDosing, water intake to the **U** compartment takes place solely via the capsule. Do not add any additional fabric softener to the **U** compartment.

■ Close the lid and press it firmly shut.

■ Close the dispenser drawer.

The programme will dispense the contents of the capsule at the correct time.

When using CapDosing, water intake to the **U** compartment takes place solely via the capsule. Do not add any additional fabric softener to the **U** compartment.

■ Open the lid of the **U** compartment.

■ Close the dispenser drawer.

The programme will dispense the contents of the capsule at the correct time.

When using CapDosing, water intake to the **U** compartment takes place solely via the capsule. Do not add any additional fabric softener to the **U** compartment.

■ Open the lid of the **U** compartment.

■ Close the dispenser drawer.

The programme will dispense the contents of the capsule at the correct time.

Extras

Short

For light soiling with no visible staining. The programme sequence is reduced. Mechanical action and energy usage are increased.

Pre-ironing

The laundry undergoes a smoothing process with steam at the end of the programme. For optimal smoothing, reduce the maximum load by 50%. Small loads achieve a better result. The garments must be suitable for drying in a tumble dryer and suitable for ironing.

SingleWash

For efficiently washing a very small load (< 1 kg) in a normal wash programme. The wash duration is reduced. Please note the following advice:

- Use liquid detergent.
- For manual dosing: Reduce the dosage to a maximum of 50% of the amount quoted for a ½ load.

Extra quiet

This option reduces noise levels during the wash programme. Use this if you want to wash laundry during quiet periods (for instance when children are sleeping). The **Rinse hold Extra** is switched on automatically, deactivating the final spin. The programme running time is extended.

Hygiene plus

The hygiene requirements for laundry are increased. The temperature holding time is extended in the main wash to improve the rinsing efficiency. This will increase the water and energy consumption for the programme. The laundry must be suitable for drying in a tumble dryer and suitable for ironing.

Pre-wash

For laundry with large amounts of dirt, e.g. dust and sand.

Soak

For heavily soiled fabrics with protein stains. The soak duration can be set to between 30 minutes and 6 hours via **Settings > Appliance functions > Soak**.

Stains

For cleaning stained laundry. The programme sequence is altered with this wash Extra.

Save energy

The wash temperature is reduced and the wash duration is increased.

Rinse plus

Activates 1 to 3 extra rinses for excellent results. The number of rinse cycles can be set under **Settings > Appliance functions > Rinse plus**.

Rinse hold

The laundry is not spun after the final rinse and remains in the rinse water. This helps prevent creasing if the laundry is not going to be removed from the washing machine immediately after the end of the programme.





view includes most of the programmes. A complete programme overview can be found in the operating instructions.

Programme chart

Programme	Load (kg) • Spin (rpm)	Temperature	Items	Tips
Cottons	9.0 • 1600	Cold to 90 °C	Cotton, linen or mixed fibre fabric, e.g. T-shirts, underwear, table linen	Where particularly high levels of hygiene are required, please select a temperature of 60 °C or higher. Reduce the final spin speed for fabric that creases easily.
Minimum iron	4.0 • 1200	Cold to 60 °C	Synthetic and mixed fibre textiles as well as easy care cotton e.g. jumpers, dresses, trousers and socks/tights	Fast and thorough cleaning of laundry with increased energy and water consumption.
QuickPowerWash	4.0 • 1600	40 °C and 60 °C	Lightly or moderately soiled cottons, linen or mixed fibres that are also suitable for the Cottons programme	Whether it is used for washing 6 x 1 kg or 1 x 6 kg, the programme offers consistently high wash results with the same water and energy consumption per kg.
SmartMatic	6.0 • 1400	-	Cottons and synthetic fibre or mixed fibre textiles which can be washed at a temperature of 30 °C and higher	Reduce the final spin speed for fabric that creases easily.
Woolens	3.0 • 1000	Cold to 40 °C	Machine-washable or hand-washable wool or wool blend fabric e.g. jumpers, cardigans, socks/tights	- Pre-treat collars and cuffs if necessary. - The <i>Pre-ironing Extra</i> is activated automatically. - Wash silk shirts and blouses in the <i>Silks</i> programme.
Shirts/Blouses	1.0 • 1000	Cold to 60 °C	Shirts and blouses made of cotton and mixed fibre	For items which crease easily, select the <i>Pre-ironing Extra</i> .
Delicates	3.0 • 1000	Cold to 40 °C	Delicate garments made from synthetic fibre, mixed fibre and viscose e.g. lingerie and appliquéd garments	- Smaller loads give a better result. - Selecting <i>TwinDos</i> ensures a fresh fragrance.
PowerFresh	1.0 • -	Steam	Dry and clean cotton, linen or mixed fibre textiles which are slightly creased. The textiles must be suitable for drying in a tumble dryer and suitable for ironing .	- Remove garments as soon as the programme has finished and hang them up on a coat hanger. - The programme is not suitable for garments made of wool or wool blend fabric.
Dark garments/Denim	4.0 • 1200	Cold to 60 °C	Black and dark cotton or mixed fibre textiles and denim e.g. jackets, trousers, shirts, skirts	- Wash inside out. - Denim often contains excess dye and may run during the first few washes. Therefore, wash light and coloured denim items separately. - The <i>Short Extra</i> is activated automatically.
Express 20	3.0 • 1200	Cold to 40 °C	Cotton garments that have hardly been worn or are only very lightly soiled	- Reduces creasing after washing and minimises the ironing effort. - 5–6 shirts make up a load of approx. 2.0 kg. - Smaller loads give a better result.
Pre-ironing only	2.0 • -	Steam	Damp, freshly washed and spun textiles that are suitable for drying in a tumble dryer and suitable for ironing .	- Remove garments as soon as the programme has finished and hang them up on a coat hanger. - Not suitable for garments made of wool or wool blend fabric.

fold here

PROGRAMME CHART

fold here

Detergent

This detergent table only includes some of the programmes. A complete overview can be found in the operating instructions.

Detergent recommendations
The recommendations apply across the entire temperature range of the wash programmes.

	Miele UltraPhase 1 and 2	Miele capsules	Miele capsules	Miele capsules	Universal detergent	Colour detergent	Detergent for delicates and woollens	Special-purpose detergent
Cottons	✓		✓	✓	✓	✓		
ECO 40-60	✓		✓	✓	✓	✓		
Minimum iron	✓		✓	✓	✓	✓		
QuickPowerWash	✓		✓	✓	✓	✓		
SmartMatic	✓		✓	✓	✓	✓		
Woolens		✓					✓	✓
Shirts/Blouses	✓		✓	✓	✓	✓		
Delicates	✓	✓	✓	✓			✓	
PowerFresh	✓							
Dark garments/Denim	✓		✓	✓	✓	✓		
Outerwear	✓	✓					✓	✓
Express 20	✓		✓			✓ ¹		

- ✓ Recommended
- ¹ Liquid detergent
- ² Powder detergent
- Special-purpose detergent (e.g. WoolCare)
- Fabric care product (e.g. fabric softener)
- Additive (e.g. Caps Booster)

Cleaning and care

Cleaning the housing, drum and control panel

⚠ Risk of electric shock!
Mains voltage is present when the washing machine is switched off. Disconnect the machine from the electricity supply before cleaning or maintenance.

⚠ Risk of damage due to ingress of water.
The pressure of a water jet can cause water to get into the washing machine, resulting in damage to components. Do not spray the washing machine with a water jet or high pressure hose.

Cleaning recommendation:

As required
Tools required:
Soft cleaning cloth, mild cleaning agent or soapy water
Further information can be found in the operating instructions.

Cleaning the dispenser drawer

Cleaning recommendation:
Every 4 weeks at the beginning, even if you only use TwinDos. If there is no heavy soiling, you can extend the intervals.

Tools required:
Bottle brush
The following parts must be cleaned:

- Dispenser drawer
- Siphon and compartment channel
- Dispenser drawer housing

Further information can be found in the operating instructions.

fold here

fold here

Cleaning the water intake filter/s

Cleaning recommendation:
Every 6 months. Perform this check more often if there are frequent interruptions to the external water supply.

Tools required:
Screwdriver, long nose pliers
Further information can be found in the operating instructions.

Cleaning TwinDos

Cleaning the compartment

Cleaning recommendation:
Each time the cartridges are changed

Tools required:
Damp cloth

Cleaning programme

Cleaning recommendation:
Longer downtime of more than 2 months or when changing the detergent

Tool required:

TwinDos Care cleaning cartridge or refill container
Further information can be found in the operating instructions.

Cleaning the drum/Hygiene in the washing machine

Cleaning the drum

Cleaning recommendation:
As required

Cleaning programme
Cleaning recommendation:
Message in the display

Tools required:
Miele IntenseClean machine cleaner or a universal powder detergent
Further information can be found in the operating instructions.

fold here

fold here

Problem solving guide

Problem	Possible cause and remedy
Washing machine does not switch on. The display remains dark.	There is no power to the washing machine. <ul style="list-style-type: none"> ■ Check whether the mains plug is plugged in and switched on. ■ Check whether the circuit breaker has tripped. The proximity sensor is switched off. The proximity sensor does not respond. <ul style="list-style-type: none"> ■ Press and switch on the washing machine. ■ Check the <i>Proximity sensor</i> setting in Settings. ■ Check the proximity sensor by approaching the washing machine from the front.
▶ is dark and cannot be activated.	The door is not closed properly. <ul style="list-style-type: none"> ■ Open the door and close it again. The washing machine has an automatic safety lock. The washing machine can only be started within 60 seconds of the last operational step on the control panel. <ul style="list-style-type: none"> ■ Confirm the question: <i>Release safety lock?</i> by touching the <i>OK</i> sensor. ■ You now have another 60 seconds in which to start the wash programme.
Fault F34	The door is not closed properly. The door lock could not engage. <ul style="list-style-type: none"> ■ Close the door again. ■ Start the programme again. ■ If the same fault message appears again, contact Miele Customer Service.
Fault F35	The door lock has jammed. <ul style="list-style-type: none"> ■ Switch the washing machine off and on again. ■ If the same fault message appears again, contact Miele Customer Service.
Fault F10 • Water inlet	The washing machine could not draw in enough water. <ul style="list-style-type: none"> ■ Check whether the tap has been opened or properly opened. ■ Check whether the water inlet hose is kinked. ■ Check that the water connection pressure is sufficient. The minimum pressure is 100 kPa (1 bar). If the water connection pressure is permanently below the minimum value, the “Low water pressure” setting can be activated.

CLEANING AND CARE

fold here

Problem	Possible cause and remedy
Fault F11 • Water drainage	The drain pumps are dirty or blocked. <ul style="list-style-type: none"> ■ Clean the drain filters and drain pumps (see “Problem solving guide – Draining the suds solution in the event of a fault” in the operating instructions). The drain hose has been fixed too high. <ul style="list-style-type: none"> ■ Observe the maximum delivery head of 1.0 m.
Fault F138	The water protection system has reacted. <ul style="list-style-type: none"> ■ Turn off the tap. ■ Contact Miele Customer Service.
Fault F210 • Circulation	The drain pumps and the nozzle in the door sealing ring are dirty. <ul style="list-style-type: none"> ■ Clean the drain pumps and the nozzle in the door sealing ring (see “Problem solving guide – Draining the suds solution in the event of a fault” in the operating instructions). ■ Start a wash programme again after cleaning. If the same fault message appears again, contact Miele Customer Service.
Fault F373 • Leak at drain filter	The washing machine has detected a leak in the drain filter. <ul style="list-style-type: none"> ■ Check the drain filter and tighten it again. ■ Switch the washing machine off and on again. ■ If the fault occurs again, contact Miele Customer Service.
Fault FXXX Switch the appliance off and on again. If the fault persists, call Miele.	The washing machine has detected a fault. <ul style="list-style-type: none"> ■ Disconnect the washing machine from the mains electricity supply. Switch off at the wall and withdraw the plug from the socket, or switch off the mains circuit breaker. Disconnect the washing machine from the mains supply for at least 2 minutes. <ul style="list-style-type: none"> ■ Reconnect the washing machine to the electricity supply. ■ Then switch the washing machine on again. ■ Restart the programme. If the fault occurs again, contact Miele Customer Service.

fold here

Problem	Possible cause and remedy
Fault F11 • Water drainage	The drain pumps are dirty or blocked. <ul style="list-style-type: none"> ■ Clean the drain filters and drain pumps (see “Problem solving guide – Draining the suds solution in the event of a fault” in the operating instructions). The drain hose has been fixed too high. <ul style="list-style-type: none"> ■ Observe the maximum delivery head of 1.0 m.
Fault F138	The water protection system has reacted. <ul style="list-style-type: none"> ■ Turn off the tap. ■ Contact Miele Customer Service.
Fault F210 • Circulation	The drain pumps and the nozzle in the door sealing ring are dirty. <ul style="list-style-type: none"> ■ Clean the drain pumps and the nozzle in the door sealing ring (see “Problem solving guide – Draining the suds solution in the event of a fault” in the operating instructions). ■ Start a wash programme again after cleaning. If the same fault message appears again, contact Miele Customer Service.
Fault F373 • Leak at drain filter	The washing machine has detected a leak in the drain filter. <ul style="list-style-type: none"> ■ Check the drain filter and tighten it again. ■ Switch the washing machine off and on again. ■ If the fault occurs again, contact Miele Customer Service.
Fault FXXX Switch the appliance off and on again. If the fault persists, call Miele.	The washing machine has detected a fault. <ul style="list-style-type: none"> ■ Disconnect the washing machine from the mains electricity supply. Switch off at the wall and withdraw the plug from the socket, or switch off the mains circuit breaker. Disconnect the washing machine from the mains supply for at least 2 minutes. <ul style="list-style-type: none"> ■ Reconnect the washing machine to the electricity supply. ■ Then switch the washing machine on again. ■ Restart the programme. If the fault occurs again, contact Miele Customer Service.

fold here

PROBLEM SOLVING GUIDE

Quick Start Guide

Washing machine



These short instructions are not a substitute for the operating instructions supplied with the appliance. It is essential to familiarise yourself with the washing machine before using it for the first time. Take note of the Warning and Safety Instructions, as well as the full descriptions on how to use your appliance.

en-AU, NZ

M.-Nr. 12 702 631 / 00

